

N-Channel Enhancement Mode Field Effect Transistor

NDT3055

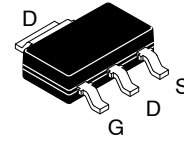

SOT-223
CASE 318H-01

General Description

These N-Channel enhancement mode power field effect transistors are produced using onsemi's proprietary, high cell density, DMOS technology. This very high density process is especially tailored to minimize on-state resistance and provide superior switching performance. These devices are particularly suited for low voltage applications such as DC motor control and DC/DC conversion where fast switching, low in-line power loss, and resistance to transients are needed.

Features

- 4 A, 60 V
 - ◆ $R_{DS(ON)} = 0.100 \Omega @ V_{GS} = 10 V$
- High Density Cell Design for Extremely Low $R_{DS(ON)}$
- High Power and Current Handling Capability in a Widely Used Surface Mount Package
- This is a Pb-Free Device

ABSOLUTE MAXIMUM RATINGS ($T_A = 25^\circ C$, unless otherwise noted)

| Symbol | Parameter | Value | Unit |
|----------------|---|------------------------|------------|
| V_{DSS} | Drain-Source Voltage | 60 | V |
| V_{GSS} | Gate-Source Voltage | ± 20 | V |
| I_D | Drain Current | - Continuous (Note 1a) | 4 |
| | | - Pulsed | 25 |
| P_D | Maximum Power Dissipation (Note 1a) | | 3 |
| | | (Note 1b) | 1.3 |
| | | (Note 1c) | 1.1 |
| T_J, T_{STG} | Operating and Storage Temperature Range | -65 to 150 | $^\circ C$ |

Stresses exceeding those listed in the Maximum Ratings table may damage the device. If any of these limits are exceeded, device functionality should not be assumed, damage may occur and reliability may be affected.

THERMAL CHARACTERISTICS ($T_A = 25^\circ C$, unless otherwise noted)

| Symbol | Parameter | Max | Unit |
|-----------------|---|-----|--------------|
| $R_{\theta JA}$ | Thermal Resistance, Junction-to-Ambient (Note 1a) | 42 | $^\circ C/W$ |
| $R_{\theta JC}$ | Thermal Resistance, Junction-to-Case (Note 1) | 12 | $^\circ C/W$ |

MARKING DIAGRAM

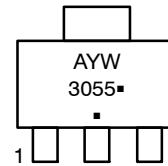

- A = Assembly Location
- Y = Year
- W = Work Week
- 3055 = Specific Device Code
- = Pb-Free Package

(Note: Microdot may be in either location)

PINOUT DIAGRAM

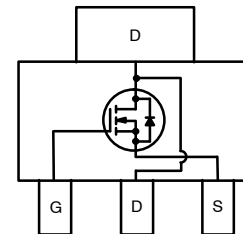

ORDERING INFORMATION

| Device | Package | Shipping [†] |
|---------|-------------------|-----------------------|
| NDT3055 | SOT-223 (Pb-Free) | 4000 / Tape & Reel |

[†]For information on tape and reel specifications, including part orientation and tape sizes, please refer to our Tape and Reel Packaging Specifications Brochure, [BRD8011/D](#).

NDT3055

ELECTRICAL CHARACTERISTICS ($T_A = 25^\circ\text{C}$ unless otherwise noted)

| Symbol | Parameter | Conditions | Min | Typ | Max | Unit |
|--------|-----------|------------|-----|-----|-----|------|
|--------|-----------|------------|-----|-----|-----|------|

OFF CHARACTERISTICS

| | | | | | | |
|--------------------------------------|---|--|----|----|------|----------------------|
| BV_{DSS} | Drain-Source Breakdown Voltage | $V_{GS} = 0\text{ V}, I_D = 250\ \mu\text{A}$ | 60 | - | - | V |
| $\frac{\Delta BV_{DSS}}{\Delta T_J}$ | Breakdown Voltage Temperature Coefficient | $I_D = 250\ \mu\text{A}$, Referenced to 25°C | - | 63 | - | mV/ $^\circ\text{C}$ |
| I_{DSS} | Zero Gate Voltage Drain Current | $V_{DS} = 48\text{ V}, V_{GS} = 0\text{ V}$ | - | - | 10 | μA |
| | | $V_{DS} = 48\text{ V}, V_{GS} = 0\text{ V}, T_J = 125^\circ\text{C}$ | - | - | 100 | |
| I_{GSSF} | Gate-Body Leakage, Forward | $V_{GS} = 20\text{ V}, V_{DS} = 0\text{ V}$ | - | - | 100 | nA |
| I_{GSSR} | Gate-Body Leakage, Reverse | $V_{GS} = -20\text{ V}, V_{DS} = 0\text{ V}$ | - | - | -100 | nA |

ON CHARACTERISTICS (Note 2)

| | | | | | | |
|--------------|-----------------------------------|--|-----|-------|------|----------|
| $V_{GS(th)}$ | Gate Threshold Voltage | $V_{DS} = V_{GS}, I_D = 250\ \mu\text{A}$ | 2 | 3 | 4 | V |
| | | $V_{DS} = V_{GS}, I_D = 250\ \mu\text{A}, T_J = 125^\circ\text{C}$ | 1.5 | 2.4 | 3 | |
| $R_{DS(on)}$ | Static Drain-Source On-Resistance | $V_{GS} = 10\text{ V}, I_D = 4\text{ A}$ | - | 0.084 | 0.1 | Ω |
| | | $V_{GS} = 10\text{ V}, I_D = 4\text{ A}, T_J = 125^\circ\text{C}$ | - | 0.14 | 0.18 | |
| $I_{D(on)}$ | On-State Drain Current | $V_{GS} = 10\text{ V}, V_{DS} = 10\text{ V}$ | 15 | - | - | A |
| g_{FS} | Forward Transconductance | $V_{DS} = 15\text{ V}, I_D = 4\text{ A}$ | - | 6 | - | S |

DYNAMIC CHARACTERISTICS

| | | | | | | |
|-----------|------------------------------|---|---|-----|---|----|
| C_{iss} | Input Capacitance | $V_{DS} = 30\text{ V}, V_{GS} = 0\text{ V}, f = 1.0\text{ MHz}$ | - | 250 | - | pF |
| C_{oss} | Output Capacitance | | - | 100 | - | pF |
| C_{rss} | Reverse Transfer Capacitance | | - | 30 | - | pF |

SWITCHING CHARACTERISTICS (Note 2)

| | | | | | | |
|--------------|-----------------------|--|---|-----|----|----|
| $t_{d(on)}$ | Turn - On Delay Time | $V_{DD} = 25\text{ V}, I_D = 1.2\text{ A}, V_{GS} = 10\text{ V}, R_{GEN} = 50\ \Omega$ | - | 10 | 25 | ns |
| t_r | Turn - On Rise Time | | - | 18 | 50 | ns |
| $t_{d(off)}$ | Turn - Off Delay Time | | - | 37 | 65 | ns |
| t_f | Turn - Off Fall Time | | - | 30 | 60 | ns |
| Q_g | Total Gate Charge | $V_{DS} = 40\text{ V}, I_D = 4\text{ A}, V_{GS} = 10\text{ V}$ | - | 9 | 15 | nC |
| Q_{gs} | Gate-Source Charge | | - | 2.3 | - | nC |
| Q_{gd} | Gate-Drain Charge | | - | 2.6 | - | nC |

DRAIN-SOURCE DIODE CHARACTERISTICS AND MAXIMUM RATINGS

| | | | | | | |
|----------|---|--|---|------|-----|---|
| I_S | Maximum Continuous Drain-Source Diode Forward Current | - | - | 2.5 | A | |
| V_{SD} | Drain-Source Diode Forward Voltage | $V_{GS} = 0\text{ V}, I_S = 2.5\text{ A}$ (Note 2) | - | 0.85 | 1.2 | V |

Product parametric performance is indicated in the Electrical Characteristics for the listed test conditions, unless otherwise noted. Product performance may not be indicated by the Electrical Characteristics if operated under different conditions.

- $R_{\theta JA}$ is the sum of the junction-to-case and case-to-ambient thermal resistance where the case thermal reference is defined as the solder mounting surface of the drain pins. $R_{\theta JC}$ is guaranteed by design while $R_{\theta CA}$ is determined by the user's board design. Typical $R_{\theta JA}$ using the board layouts shown below on FR-4 PCB in a still air environment:

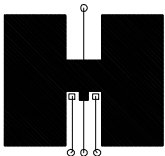

a. 42°C/W when mounted on a 1 in^2 pad of 2 oz copper.



b. 95°C/W when mounted on a 0.066 in^2 pad of 2 oz copper.

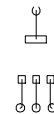

c. 110°C/W when mounted on a 0.00123 in^2 pad of 2 oz Cu..

- Pulse Test: Pulse Width $\leq 300\ \mu\text{s}$, Duty Cycle $\leq 2.0\%$.

TYPICAL ELECTRICAL CHARACTERISTICS

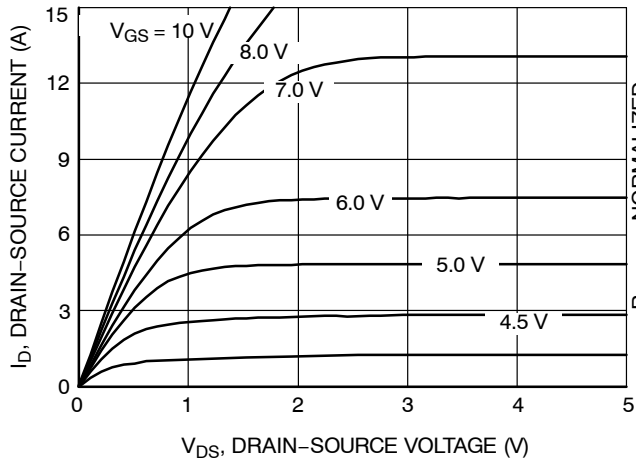

Figure 1. On-Region Characteristics

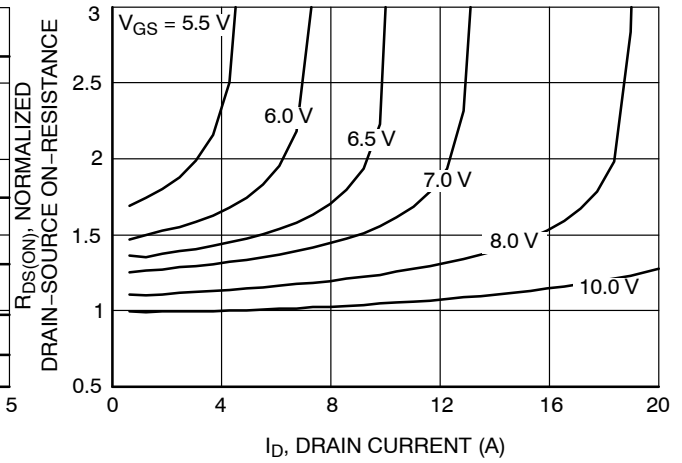

Figure 2. On-Resistance Variation with Drain Current and Gate Voltage

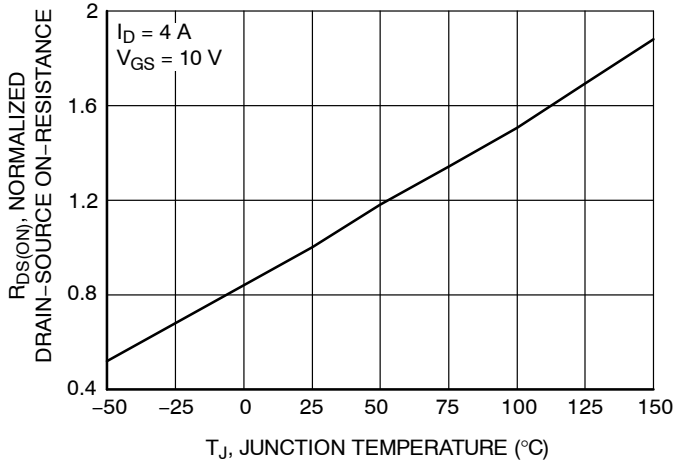

Figure 3. On-Resistance Variation with Temperature

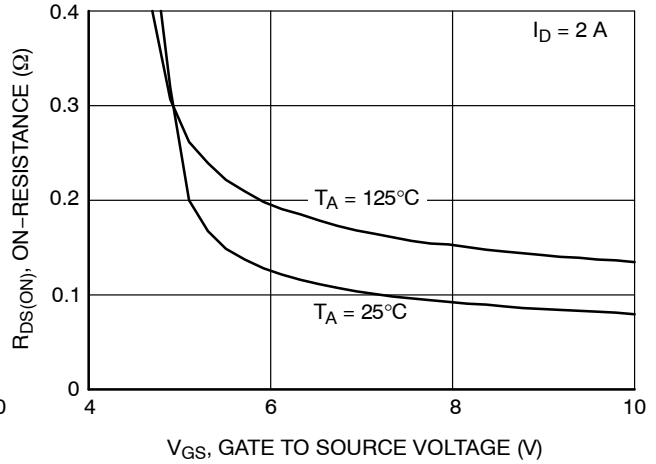

Figure 4. On-Resistance Variation with Gate-to-Source Voltage

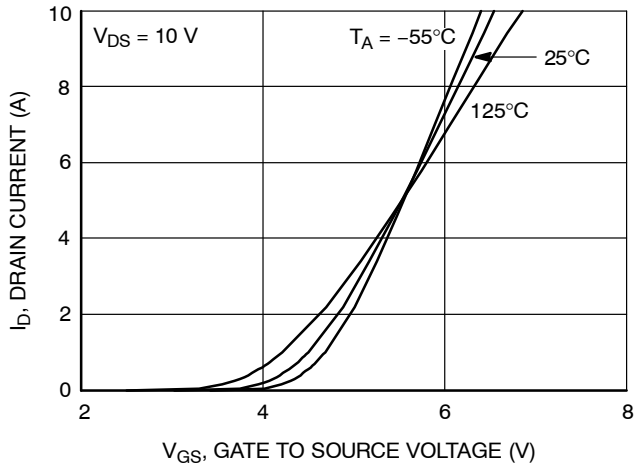

Figure 5. Transfer Characteristics

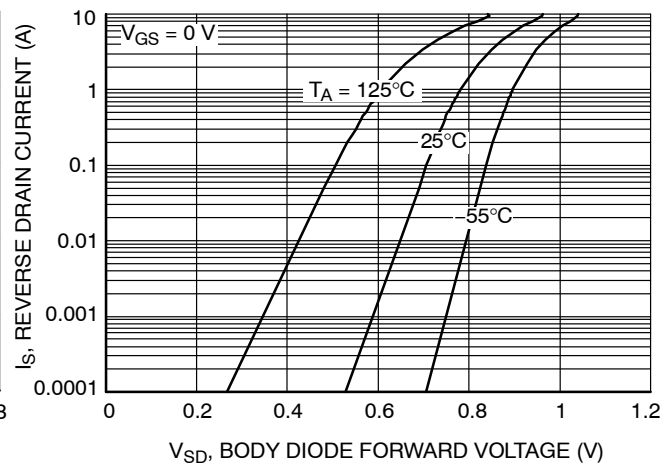

Figure 6. Body Diode Forward Voltage Variation with Source Current and Temperature

TYPICAL ELECTRICAL CHARACTERISTICS (continued)

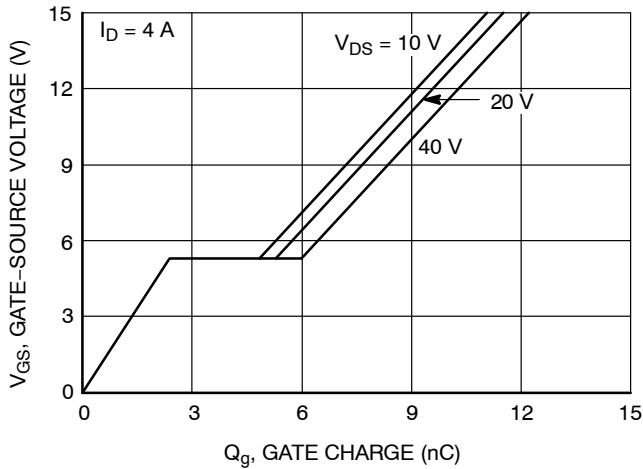

Figure 7. Gate Charge Characteristics

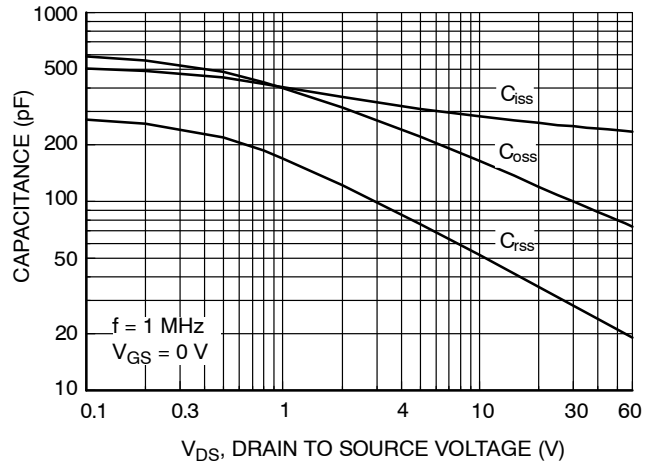

Figure 8. Capacitance Characteristics

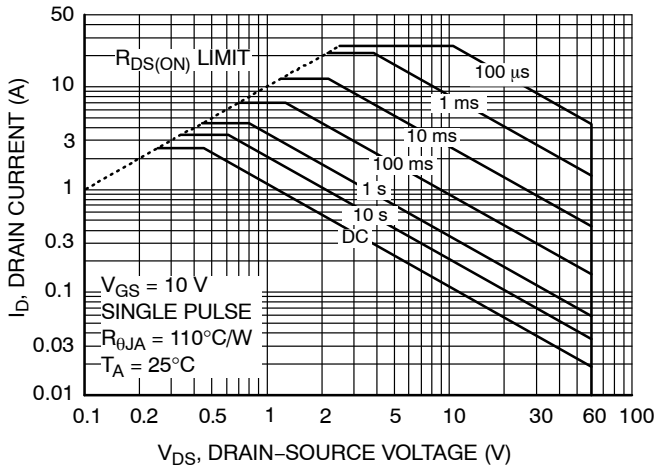

Figure 9. Maximum Safe Operating Area

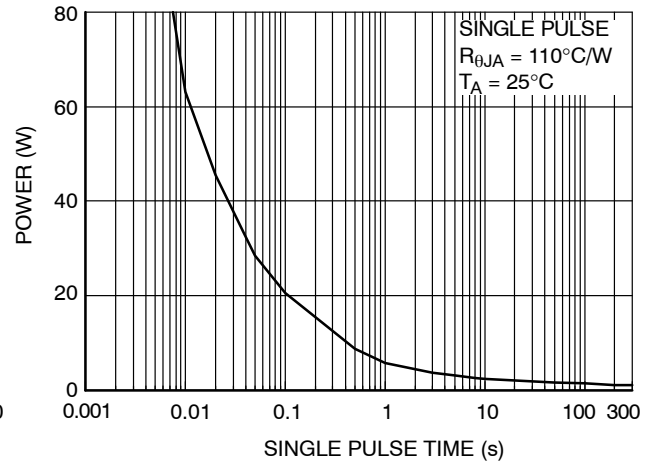

Figure 10. Single Pulse Maximum Power Dissipation

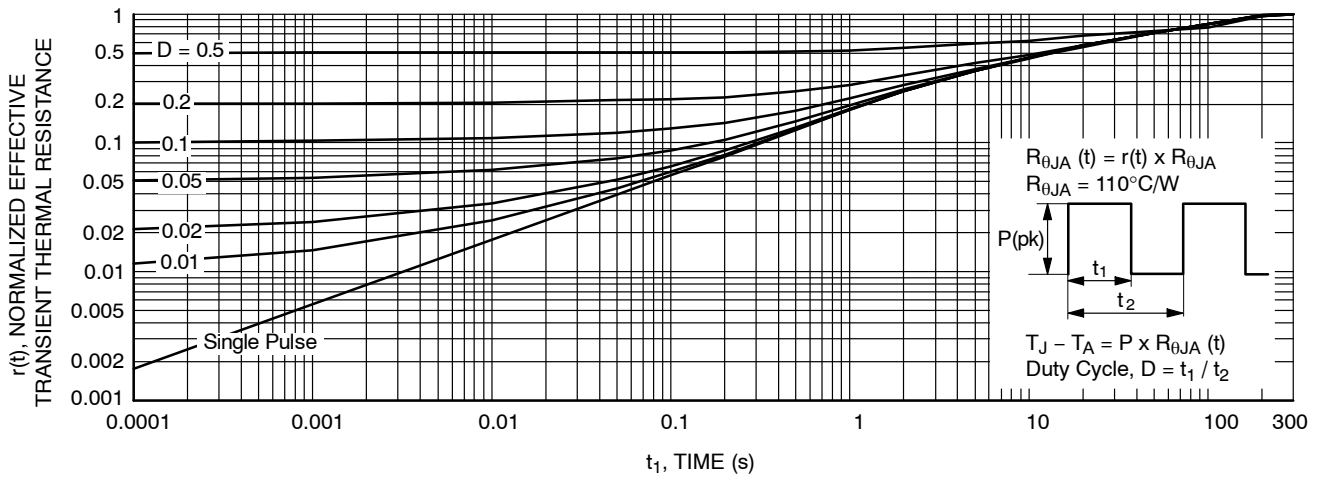
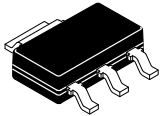

Figure 11. Transient Thermal Response Curve

Thermal characterization performed using the conditions described in Note 1c. Transient thermal response will change depending on the circuit board design.



SCALE 2:1

SOT-223
CASE 318H
ISSUE B

DATE 13 MAY 2020

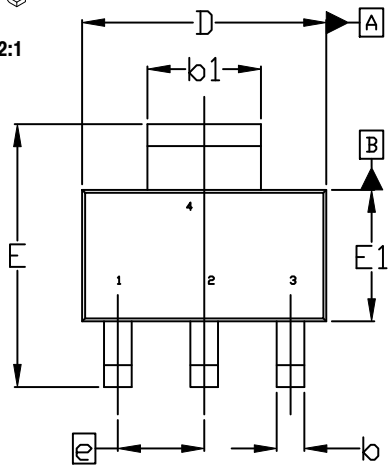

TOP VIEW

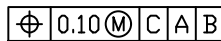

NOTE 7

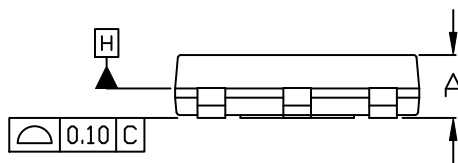

SIDE VIEW

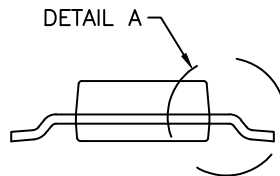

END VIEW

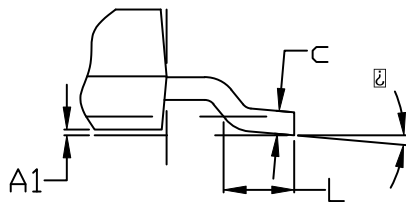

DETAIL A

NOTES:

1. DIMENSIONING AND TOLERANCING PER ASME Y14.5M, 2009.
2. CONTROLLING DIMENSION: MILLIMETERS
3. DIMENSIONS D & E1 ARE DETERMINED AT DATUM H. DIMENSIONS DO NOT INCLUDE MOLD FLASH, PROTRUSIONS OR GATE BURRS. SHALL NOT EXCEED 0.23mm PER SIDE.
4. LEAD DIMENSIONS b AND b1 DO NOT INCLUDE DAMBAR PROTRUSION. ALLOWABLE DAMBAR PROTRUSION IS 0.08mm PER SIDE.
5. DATUMS A AND B ARE DETERMINED AT DATUM H.
6. A1 IS DEFINED AS THE VERTICAL DISTANCE FROM THE SEATING PLANE TO THE LOWEST POINT OF THE PACKAGE BODY.
7. POSITIONAL TOLERANCE APPLIES TO DIMENSIONS b AND b1.

| DIM | MILLIMETERS | | |
|------------|-------------|------|------|
| | MIN. | NOM. | MAX. |
| A | --- | --- | 1.80 |
| A1 | 0.02 | 0.06 | 0.11 |
| b | 0.60 | 0.74 | 0.88 |
| b1 | 2.90 | 3.00 | 3.10 |
| c | 0.24 | --- | 0.35 |
| D | 6.30 | 6.50 | 6.70 |
| E | 6.70 | 7.00 | 7.30 |
| E1 | 3.30 | 3.50 | 3.70 |
| e | 2.30 BSC | | |
| L | 0.25 | --- | --- |
| C | 0° | --- | 10° |

GENERIC MARKING DIAGRAM*

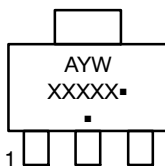

- A = Assembly Location
- Y = Year
- W = Work Week
- XXXXX = Specific Device Code
- = Pb-Free Package

(Note: Microdot may be in either location)

*This information is generic. Please refer to device data sheet for actual part marking. Pb-Free indicator, "G" or microdot "▪", may or may not be present. Some products may not follow the Generic Marking.

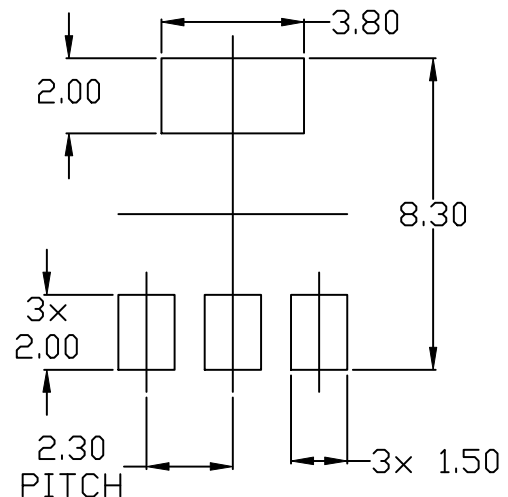

RECOMMENDED MOUNTING FOOTPRINT

* For additional information on our Pb-Free strategy and soldering details, please download the ON Semiconductor Soldering and Mounting Techniques Reference Manual, SOLDERM/D.

| | | |
|------------------|-------------|--|
| DOCUMENT NUMBER: | 98ASH70634A | Electronic versions are uncontrolled except when accessed directly from the Document Repository. Printed versions are uncontrolled except when stamped "CONTROLLED COPY" in red. |
| DESCRIPTION: | SOT-223 | PAGE 1 OF 1 |

onsemi and ONSEMI are trademarks of Semiconductor Components Industries, LLC dba onsemi or its subsidiaries in the United States and/or other countries. onsemi reserves the right to make changes without further notice to any products herein. onsemi makes no warranty, representation or guarantee regarding the suitability of its products for any particular purpose, nor does onsemi assume any liability arising out of the application or use of any product or circuit, and specifically disclaims any and all liability, including without limitation special, consequential or incidental damages. onsemi does not convey any license under its patent rights nor the rights of others.

onsemi, **Onsemi**, and other names, marks, and brands are registered and/or common law trademarks of Semiconductor Components Industries, LLC dba "**onsemi**" or its affiliates and/or subsidiaries in the United States and/or other countries. **onsemi** owns the rights to a number of patents, trademarks, copyrights, trade secrets, and other intellectual property. A listing of **onsemi**'s product/patent coverage may be accessed at www.onsemi.com/site/pdf/Patent-Marking.pdf. **onsemi** reserves the right to make changes at any time to any products or information herein, without notice. The information herein is provided "as-is" and **onsemi** makes no warranty, representation or guarantee regarding the accuracy of the information, product features, availability, functionality, or suitability of its products for any particular purpose, nor does **onsemi** assume any liability arising out of the application or use of any product or circuit, and specifically disclaims any and all liability, including without limitation special, consequential or incidental damages. Buyer is responsible for its products and applications using **onsemi** products, including compliance with all laws, regulations and safety requirements or standards, regardless of any support or applications information provided by **onsemi**. "Typical" parameters which may be provided in **onsemi** data sheets and/or specifications can and do vary in different applications and actual performance may vary over time. All operating parameters, including "Typicals" must be validated for each customer application by customer's technical experts. **onsemi** does not convey any license under any of its intellectual property rights nor the rights of others. **onsemi** products are not designed, intended, or authorized for use as a critical component in life support systems or any FDA Class 3 medical devices or medical devices with a same or similar classification in a foreign jurisdiction or any devices intended for implantation in the human body. Should Buyer purchase or use **onsemi** products for any such unintended or unauthorized application, Buyer shall indemnify and hold **onsemi** and its officers, employees, subsidiaries, affiliates, and distributors harmless against all claims, costs, damages, and expenses, and reasonable attorney fees arising out of, directly or indirectly, any claim of personal injury or death associated with such unintended or unauthorized use, even if such claim alleges that **onsemi** was negligent regarding the design or manufacture of the part. **onsemi** is an Equal Opportunity/Affirmative Action Employer. This literature is subject to all applicable copyright laws and is not for resale in any manner.

ADDITIONAL INFORMATION

TECHNICAL PUBLICATIONS:

Technical Library: www.onsemi.com/design/resources/technical-documentation
onsemi Website: www.onsemi.com

ONLINE SUPPORT: www.onsemi.com/support

For additional information, please contact your local Sales Representative at www.onsemi.com/support/sales