

Field Effect Transistor - Dual, N & P-Channel, Enhancement Mode

NDC7001C

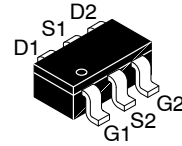

TSOT23 6-Lead
SUPERSOT-6
CASE 419BL

General Description

These dual N & P-Channel Enhancement Mode Field Effect Transistors are produced using onsemi's proprietary, high cell density, DMOS technology. This very high density process has been designed to minimize on-state resistance, provide rugged and reliable performance and fast switching. These device is particularly suited for low voltage, low current, switching, and power supply application.

Features

- Q1 0.51 A, 60 V
 $R_{DS(ON)} = 2 \Omega @ V_{GS} = 10 V$
 $R_{DS(ON)} = 4 \Omega @ V_{GS} = 4.5 V$
- Q2 -0.34 A, 60 V
 $R_{DS(ON)} = 5 \Omega @ V_{GS} = -10 V$
 $R_{DS(ON)} = 7.5 \Omega @ V_{GS} = -4.5 V$
- High Saturation Current
- High Density Cell Design for Low $R_{DS(ON)}$
- Proprietary SUPERSOT™ -6 Package Design Using Copper Lead Frame for Superior Thermal and Electrical Capabilities
- This is a Pb-Free Device

ABSOLUTE MAXIMUM RATINGS ($T_A = 25^\circ C$ unless otherwise noted)

Symbol	Parameter	Q1	Q2	Unit	
V_{DSS}	Drain-Source Voltage	60	-60	V	
V_{GSS}	Gate-Source Voltage	± 20	± 20	V	
I_D	Drain Current	- Continuous (Note 1a)	0.51	-0.34	A
		- Pulsed	1.5	-1	A
P_D	Power Dissipation for Single Operation	(Note 1a)	0.96	W	
		(Note 1b)	0.9	W	
		(Note 1c)	0.7	W	
T_J, T_{STG}	Operating and Storage Temperature Range	-55 to +150		$^\circ C$	

Stresses exceeding those listed in the Maximum Ratings table may damage the device. If any of these limits are exceeded, device functionality should not be assumed, damage may occur and reliability may be affected.

THERMAL CHARACTERISTICS

Symbol	Parameter	Ratings	Unit
$R_{\theta JA}$	Thermal Resistance, Junction to Ambient (Note 1a)	130	$^\circ C/W$
$R_{\theta JC}$	Thermal Resistance, Junction to Case (Note 1)	60	$^\circ C/W$

MARKING DIAGRAM

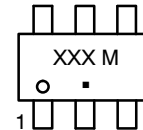

XXX = Specific Device Code
M = Date Code
▪ = Pb-Free Package

PINOUT

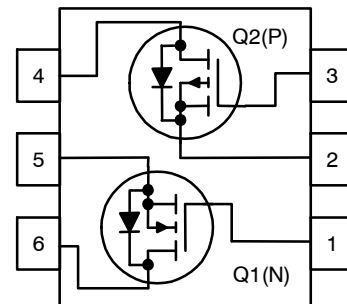

ORDERING INFORMATION

See detailed ordering and shipping information on page 8 of this data sheet.

NDC7001C

ELECTRICAL CHARACTERISTICS (T_A = 25°C unless otherwise noted)

Symbol	Parameter	Test Conditions	Min	Typ	Max	Unit
--------	-----------	-----------------	-----	-----	-----	------

OFF CHARACTERISTICS

BV _{DSS}	Drain–Source Breakdown Voltage	V _{GS} = 0 V, I _D = 250 μA V _{GS} = 0 V, I _D = –250 μA	Q1 Q2	60 –60	– –	– –	V
$\frac{\Delta BV_{DSS}}{\Delta T_J}$	Breakdown Voltage Temperature Coefficient	I _D = 250 μA, Ref. to 25°C I _D = –250 μA, Ref. to 25°C	Q1 Q2	– –	67 –57	– –	mV/°C
I _{DSS}	Zero Gate Voltage Drain Current	V _{DS} = 48 V, V _{GS} = 0 V V _{DS} = –48 V, V _{GS} = 0 V	Q1 Q2	– –	– –	1 –1	μA
I _{GSSF}	Gate–Body Leakage, Forward	V _{GS} = 20 V, V _{DS} = 0 V	All	–	–	100	nA
I _{GSSR}	Gate–Body Leakage, Reverse	V _{GS} = –20 V, V _{DS} = 0 V	All	–	–	–100	nA

ON CHARACTERISTICS (Note 2)

V _{GS(th)}	Gate Threshold Voltage	Q1	V _{DS} = V _{GS} , I _D = 250 μA	1	2.1	2.5	V
		Q2	V _{DS} = V _{GS} , I _D = –250 μA	–1	–1.9	–3.5	
$\frac{\Delta V_{GS(th)}}{\Delta T_J}$	Gate Threshold Voltage Temperature Coefficient	Q1	I _D = 250 μA, Referenced to 25°C	–	–3.8	–	mV/°C
		Q2	I _D = –250 μA, Ref. to 25°C	–	3.2	–	
R _{DS(on)}	Static Drain–Source On–Resistance	Q1	V _{GS} = 10 V, I _D = 0.51 A V _{GS} = 4.5 V, I _D = 0.35 A V _{GS} = 10 V, I _D = 0.51 A, T _J = 125°C	– – –	1 2 1.7	2 4 3.5	Ω
		Q2	V _{GS} = –10 V, I _D = –0.34 A V _{GS} = –4.5 V, I _D = –0.25 A V _{GS} = –10 V, I _D = –0.34 A, T _J = 125°C	– – –	1.2 1.5 1.9	5 7.5 10	
I _{D(on)}	On–State Drain Current	Q1	V _{GS} = 10 V, V _{DS} = 10 V	1.5	–	–	A
		Q2	V _{GS} = –10 V, V _{DS} = –10 V	–1	–	–	
g _{FS}	Forward Transconductance	Q1	V _{DS} = 10 V, I _D = 0.51 A	–	380	–	mS

DYNAMIC CHARACTERISTICS

C _{iss}	Input Capacitance	Q1	For Q1: V _{DS} = 25 V, V _{GS} = 0 V f = 1.0 MHz For Q2: V _{DS} = –25 V, V _{GS} = 0 V f = 1.0 MHz	–	20	–	pF
		Q2		–	66	–	
C _{oss}	Output Capacitance	Q1		–	11	–	pF
		Q2		–	13	–	
C _{rss}	Reverse Transfer Capacitance	Q1		–	4.3	–	pF
		Q2		–	6	–	
R _G	Gate Resistance	Q1	V _{GS} = 15 mV, f = 1.0 MHz	–	11.2	–	Ω
		Q2	–	11.2	–		

SWITCHING CHARACTERISTICS (Note 2)

t _{d(on)}	Turn–On Delay Time	Q1	For Q1: V _{DS} = 25 V, I _{DS} = 1 A V _{GS} = 10 V, R _{GEN} = 6 Ω For Q2: V _{DS} = –25 V, I _{DS} = –1 A V _{GS} = –10 V, R _{GEN} = 6 Ω	–	2.8	5.6	ns	
		Q2		–	3.2	6.4		
t _r	Turn–On Rise Time	Q1		–	8	16	ns	
		Q2		–	10	20		
t _{d(off)}	Turn–Off Delay Time	Q1		–	14	26	ns	
		Q2		–	8	16		
t _f	Turn–Off Fall Time	Q1		–	4	8	ns	
		Q2		–	1	2		
Q _g	Total Gate Charge	Q1		For Q1: V _{DS} = 25 V, I _{DS} = 0.51 A V _{GS} = 10 V, R _{GEN} = 6 Ω	–	1.1	1.5	nC
		Q2		–	1.6	2.2		
Q _{gs}	Gate–Source Charge	Q1	For Q2: V _{DS} = –25 V, I _{DS} = –0.35 A V _{GS} = –10 V, R _{GEN} = 6 Ω	–	0.2	–	nC	
		Q2	–	0.3	–			
Q _{gd}	Gate–Drain Charge	Q1	–	0.4	–	nC		

NDC7001C

ELECTRICAL CHARACTERISTICS (T_A = 25°C unless otherwise noted) (continued)

Symbol	Parameter	Test Conditions	Min	Typ	Max	Unit	
DRAIN-SOURCE DIODE CHARACTERISTICS AND MAXIMUM RATINGS							
I _S	Maximum Continuous Drain-Source Diode Forward Current	Q1	-	-	0.51	A	
		Q2	-	-	-0.34		
V _{SD}	Drain-Source Diode Forward Voltage	Q1	V _{GS} = 0 V, I _S = 0.51 A (Note 2)		-	0.8	V
		Q2	V _{GS} = 0 V, I _S = -0.34 A (Note 2)		-	-0.8	
t _{rr}	Diode Reverse Recovery Time	Q1	I _F = 0.51 A, d _{IF} /d _t = 100 A/μs		-	18	nS
		Q2	I _F = -0.34 A, d _{IF} /d _t = 100 A/μs		-	16	
Q _{rr}	Diode Reverse Recovery Charge	Q1	I _F = 0.51 A, d _{IF} /d _t = 100 A/μs		-	16	nC
		Q2	I _F = -0.34 A, d _{IF} /d _t = 100 A/μs		-	11	

Product parametric performance is indicated in the Electrical Characteristics for the listed test conditions, unless otherwise noted. Product performance may not be indicated by the Electrical Characteristics if operated under different conditions.

- R_{θJA} is the sum of the junction-to-case and case-to-ambient thermal resistance where the case thermal reference is defined as the solder mounting surface of the drain pins. R_{θJC} is guaranteed by design while R_{θCA} is determined by the user's board design.

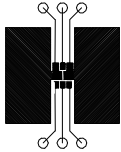

a. 130°C/W when mounted on a 0.125 in² pad of 2 oz. copper.

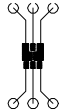

b. 140°C/W when mounted on a .005 in² pad of 2 oz. copper.



c. 180°C/W when mounted on a minimum pad.

Scale 1:1 on letter size paper

- Pulse Test: Pulse Width < 300 μs, Duty cycle < 2.0 %.

TYPICAL CHARACTERISTICS: N-CHANNEL

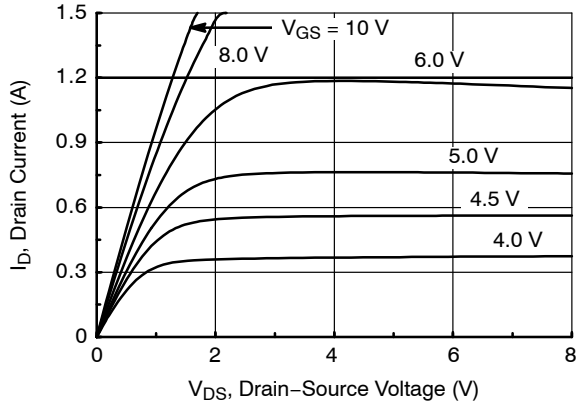

Figure 1. On-Region Characteristics

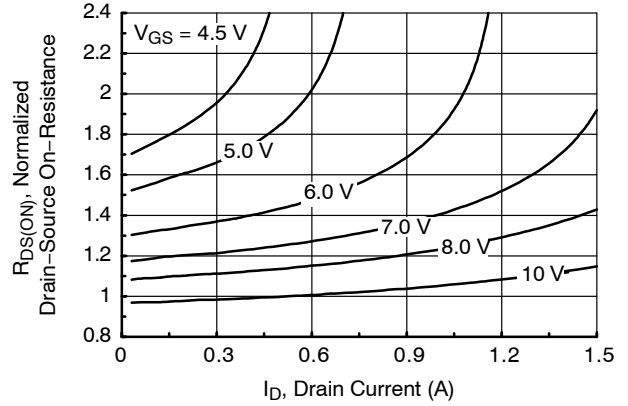

Figure 2. On-Resistance Variation with Drain Current and Gate Voltage

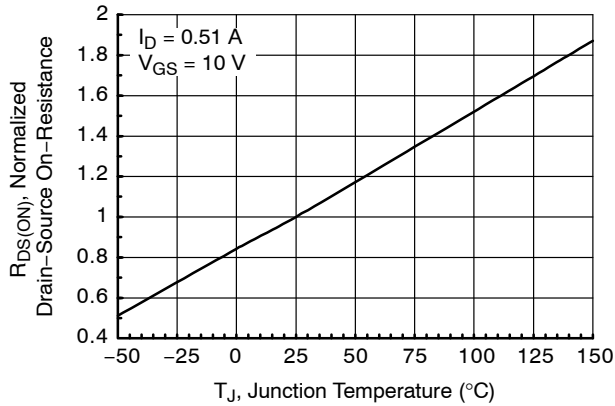

Figure 3. On-Resistance Variation with Temperature

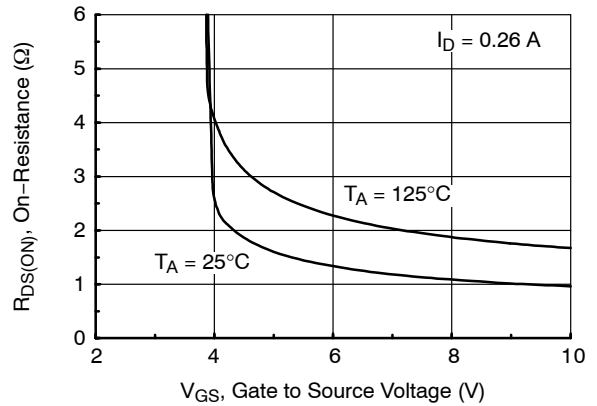

Figure 4. On-Resistance Variation with Gate-to-Source Voltage

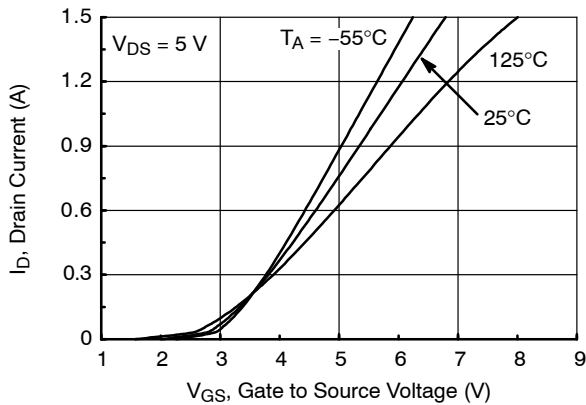

Figure 5. Transfer Characteristics

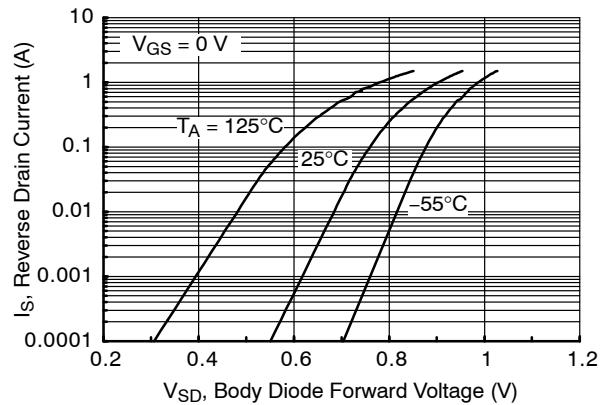

Figure 6. Body Diode Forward Voltage Variation with Source Current and Temperature

NDC7001C

TYPICAL CHARACTERISTICS: N-CHANNEL (continued)

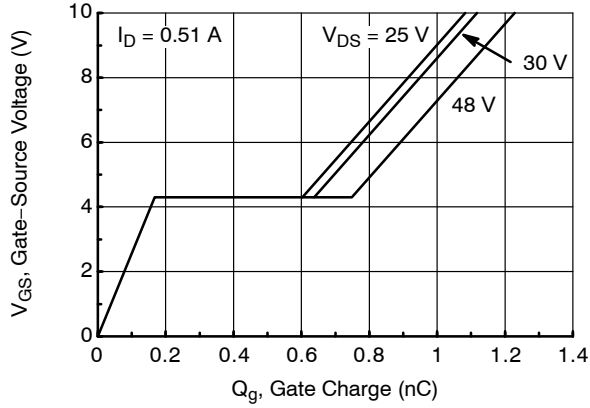

Figure 7. Gate Charge Characteristics

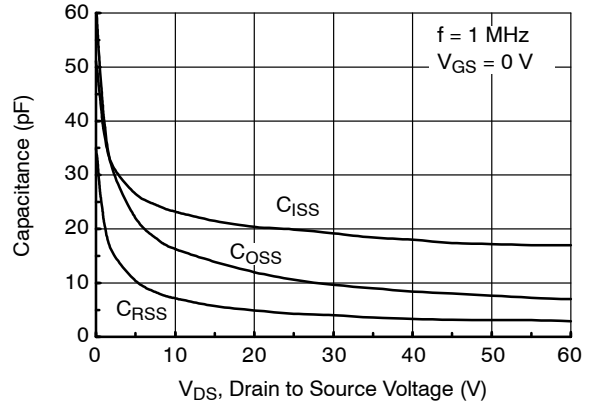

Figure 8. Capacitance Characteristics

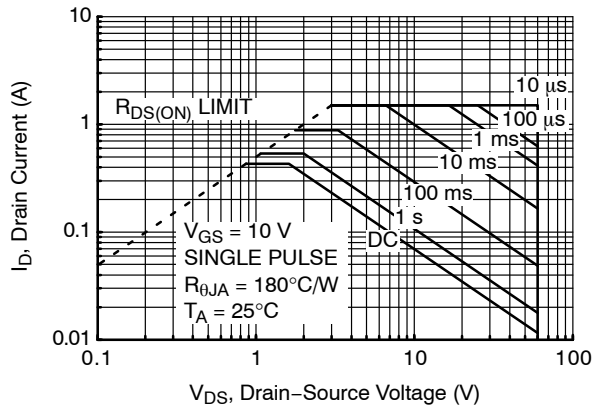

Figure 9. Maximum Safe Operating Area

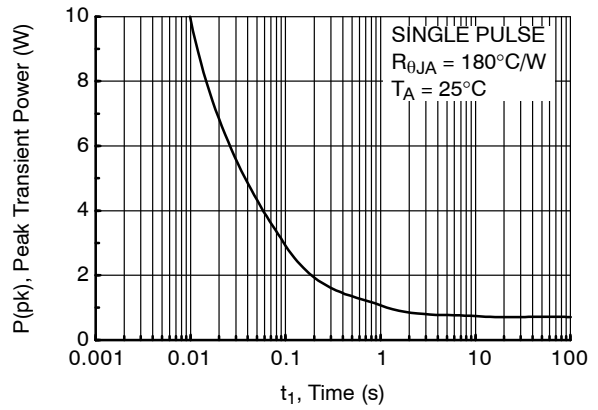

Figure 10. Single Pulse Maximum Power Dissipation

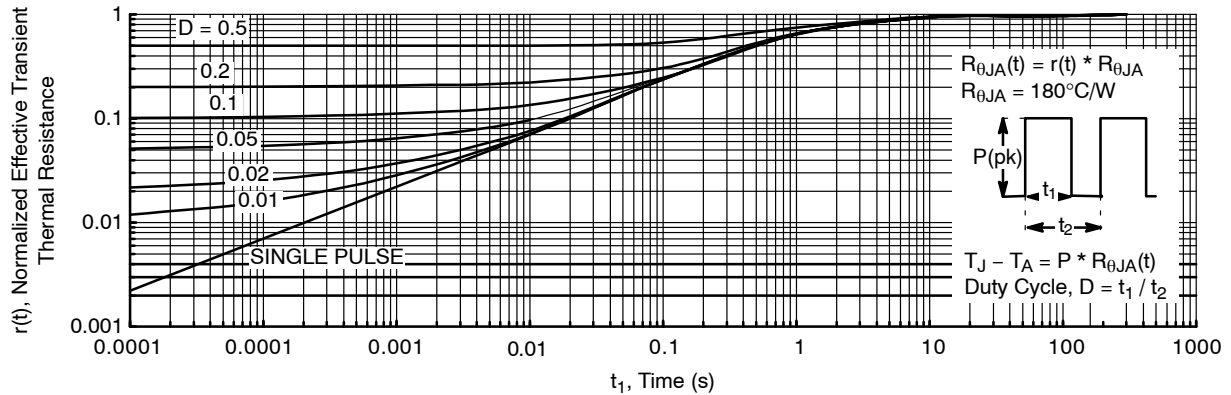

Figure 11. Transient Thermal Response Curve

(Note: Thermal characterization performed using the conditions described in Note 1c. Transient thermal response will change depending on the circuit board design.)

TYPICAL CHARACTERISTICS: P-CHANNEL

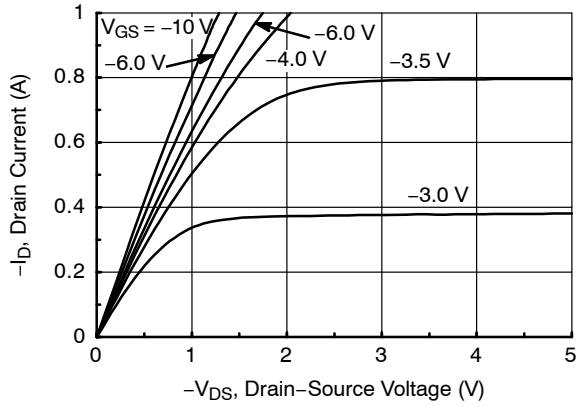

Figure 12. On-Region Characteristics

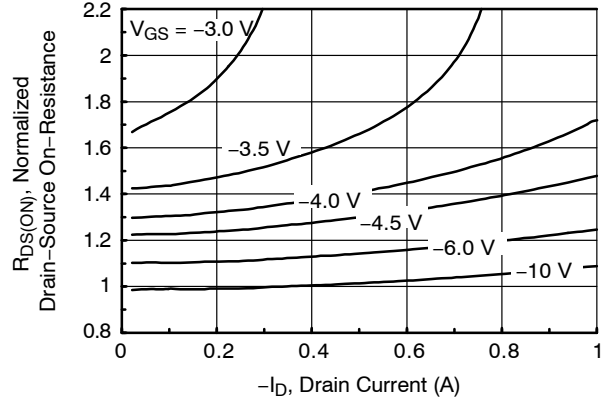

Figure 13. On-Resistance Variation with Drain Current and Gate Voltage

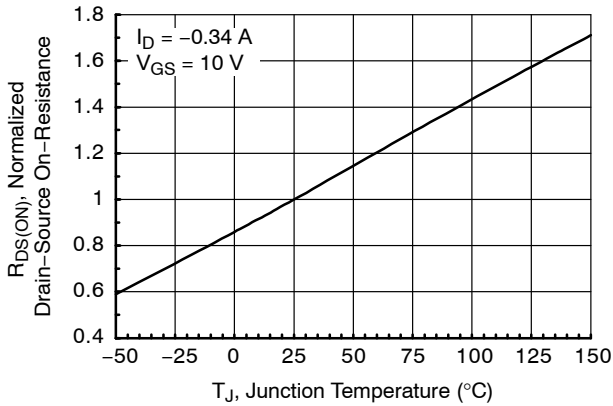

Figure 14. On-Resistance Variation with Temperature

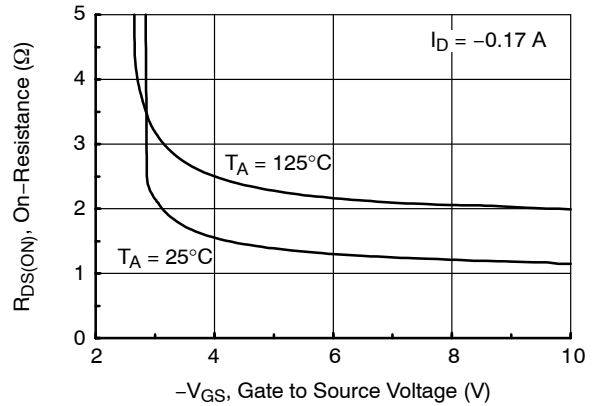

Figure 15. On-Resistance Variation with Gate-to-Source Voltage

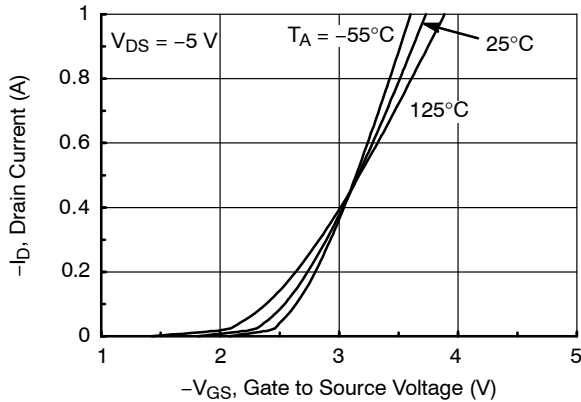

Figure 16. Transfer Characteristics

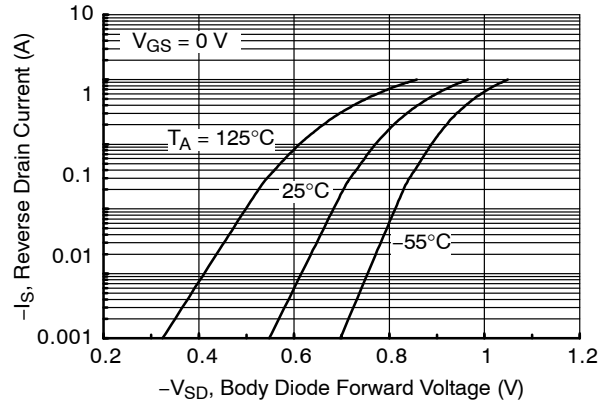

Figure 17. Body Diode Forward Voltage Variation with Current and Temperature

NDC7001C

TYPICAL CHARACTERISTICS: P-CHANNEL (continued)

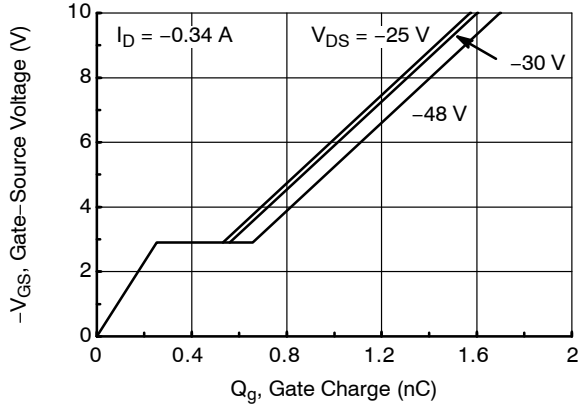

Figure 18. Gate Charge Characteristics

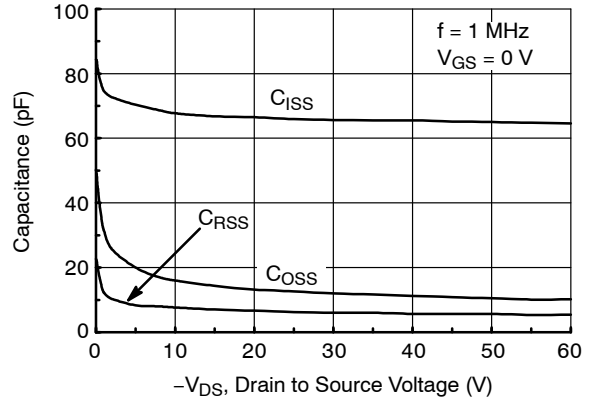

Figure 19. Capacitance Characteristics

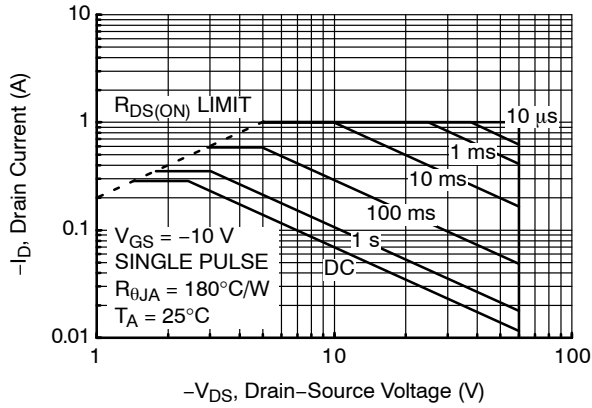

Figure 20. Maximum Safe Operating Area

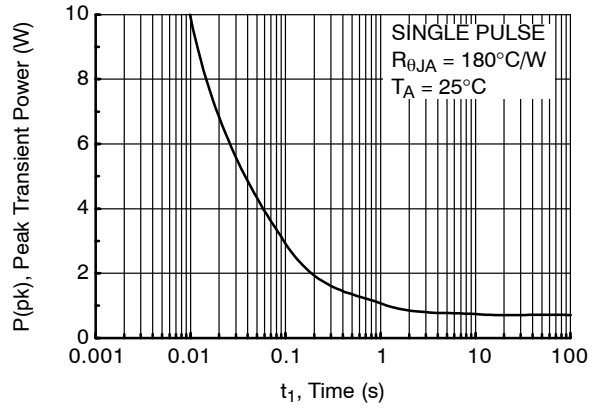

Figure 21. Single Pulse Maximum Power Dissipation

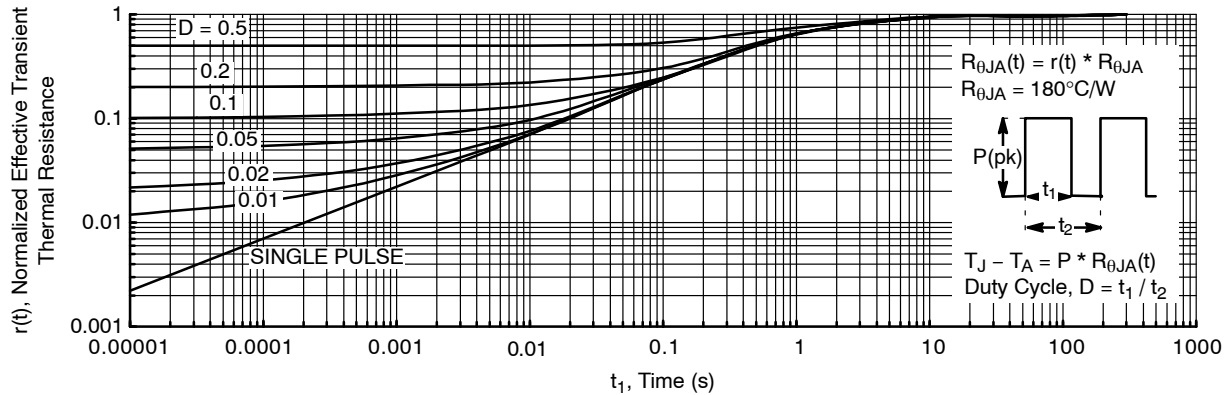

Figure 22. Transient Thermal Response Curve

(Note: Thermal characterization performed using the conditions described in Note 1c. Transient thermal response will change depending on the circuit board design.)

NDC7001C

ORDERING INFORMATION

Device	Device Marking	Package Type	Reel Size	Tape Width	Shipping [†]
NDC7001C	.01	TSOT-23-6 (Pb-free)	7"	8 mm	3000 / Tape & Reel

[†]For information on tape and reel specifications, including part orientation and tape sizes, please refer to our Tape and Reel Packaging Specifications Brochure, BRD8011/D.

SUPERSOT is a trademark of Semiconductor Components Industries, LLC dba "onsemi" or its affiliates and/or subsidiaries in the United States and/or other countries.

MECHANICAL CASE OUTLINE

PACKAGE DIMENSIONS

ON Semiconductor®



SCALE 2:1

TSOT23 6-Lead CASE 419BL ISSUE A

DATE 31 AUG 2020

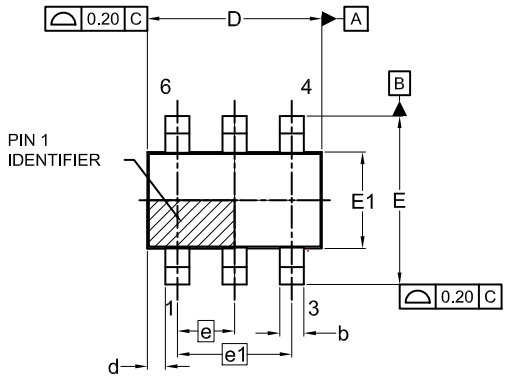

TOP VIEW



FRONT VIEW



DETAIL A

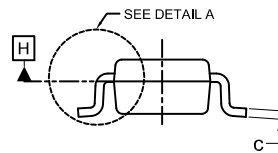

SIDE VIEW

SYMM
⌀

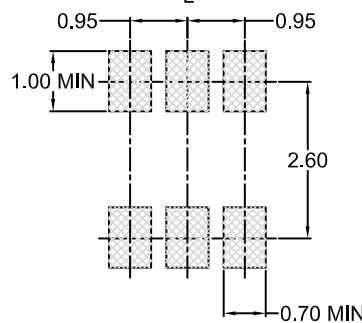

LAND PATTERN
RECOMMENDATION

*FOR ADDITIONAL INFORMATION ON OUR Pb-FREE STRATEGY AND SOLDERING DETAILS, PLEASE DOWNLOAD THE ON SEMICONDUCTOR SOLDERING AND MOUNTING TECHNIQUES REFERENCE MANUAL, SOLDERRM/D.

NOTES:

1. DIMENSIONING AND TOLERANCING PER ASME Y14.5M, 2009.
2. CONTROLLING DIMENSION: MILLIMETERS
3. DIMENSIONS D AND E1 DO NOT INCLUDE MOLD FLASH, PROTRUSIONS, OR GATE BURRS. MOLD FLASH, PROTRUSIONS OR GATE BURRS SHALL NOT EXCEED 0.25MM PER END. DIMENSIONS D AND E1 ARE DETERMINED AT DATUM H.
4. SEATING PLANE IS DEFINED BY THE TERMINALS. "A1" IS DEFINED AS THE DISTANCE FROM THE SEATING PLANE TO THE LOWEST POINT ON THE PACKAGE BODY.

DIM	MILLIMETERS		
	MIN.	NOM.	MAX.
A	0.90	1.00	1.10
A1	0.00	0.05	0.10
A2	0.70	0.85	1.00
A3	0.25 BSC		
b	0.25	0.38	0.50
c	0.10	0.18	0.26
D	2.80	2.95	3.10
d	0.30 REF		
E	2.50	2.75	3.00
E1	1.30	1.50	1.70
e	0.95 BSC		
e1	1.90 BSC		
L1	0.60 REF		
L2	0.20	0.40	0.60
⌀	0°	--	10°

GENERIC MARKING DIAGRAM*

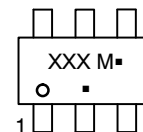

XXX = Specific Device Code
M = Date Code
▪ = Pb-Free Package

(Note: Microdot may be in either location)

*This information is generic. Please refer to device data sheet for actual part marking. Pb-Free indicator, "G" or microdot "▪", may or may not be present. Some products may not follow the Generic Marking.

DOCUMENT NUMBER:	98AON83292G	Electronic versions are uncontrolled except when accessed directly from the Document Repository. Printed versions are uncontrolled except when stamped "CONTROLLED COPY" in red.
DESCRIPTION:	TSOT23 6-Lead	PAGE 1 OF 1

ON Semiconductor and ON are trademarks of Semiconductor Components Industries, LLC dba ON Semiconductor or its subsidiaries in the United States and/or other countries. ON Semiconductor reserves the right to make changes without further notice to any products herein. ON Semiconductor makes no warranty, representation or guarantee regarding the suitability of its products for any particular purpose, nor does ON Semiconductor assume any liability arising out of the application or use of any product or circuit, and specifically disclaims any and all liability, including without limitation special, consequential or incidental damages. ON Semiconductor does not convey any license under its patent rights nor the rights of others.

onsemi, **Onsemi**, and other names, marks, and brands are registered and/or common law trademarks of Semiconductor Components Industries, LLC dba "**onsemi**" or its affiliates and/or subsidiaries in the United States and/or other countries. **onsemi** owns the rights to a number of patents, trademarks, copyrights, trade secrets, and other intellectual property. A listing of **onsemi**'s product/patent coverage may be accessed at www.onsemi.com/site/pdf/Patent-Marking.pdf. **onsemi** reserves the right to make changes at any time to any products or information herein, without notice. The information herein is provided "as-is" and **onsemi** makes no warranty, representation or guarantee regarding the accuracy of the information, product features, availability, functionality, or suitability of its products for any particular purpose, nor does **onsemi** assume any liability arising out of the application or use of any product or circuit, and specifically disclaims any and all liability, including without limitation special, consequential or incidental damages. Buyer is responsible for its products and applications using **onsemi** products, including compliance with all laws, regulations and safety requirements or standards, regardless of any support or applications information provided by **onsemi**. "Typical" parameters which may be provided in **onsemi** data sheets and/or specifications can and do vary in different applications and actual performance may vary over time. All operating parameters, including "Typicals" must be validated for each customer application by customer's technical experts. **onsemi** does not convey any license under any of its intellectual property rights nor the rights of others. **onsemi** products are not designed, intended, or authorized for use as a critical component in life support systems or any FDA Class 3 medical devices or medical devices with a same or similar classification in a foreign jurisdiction or any devices intended for implantation in the human body. Should Buyer purchase or use **onsemi** products for any such unintended or unauthorized application, Buyer shall indemnify and hold **onsemi** and its officers, employees, subsidiaries, affiliates, and distributors harmless against all claims, costs, damages, and expenses, and reasonable attorney fees arising out of, directly or indirectly, any claim of personal injury or death associated with such unintended or unauthorized use, even if such claim alleges that **onsemi** was negligent regarding the design or manufacture of the part. **onsemi** is an Equal Opportunity/Affirmative Action Employer. This literature is subject to all applicable copyright laws and is not for resale in any manner.

ADDITIONAL INFORMATION

TECHNICAL PUBLICATIONS:

Technical Library: www.onsemi.com/design/resources/technical-documentation
onsemi Website: www.onsemi.com

ONLINE SUPPORT: www.onsemi.com/support

For additional information, please contact your local Sales Representative at www.onsemi.com/support/sales

