

NCV8535

Voltage Regulator - Ultra High Accuracy, Low Iq, Low Dropout, Enable

500 mA

The NCV8535 is a high performance, low dropout regulator. With accuracy of $\pm 0.9\%$ over line and load and ultra-low quiescent current and noise it encompasses all of the necessary features required by today's consumer electronics. This unique device is guaranteed to be stable without a minimum load current requirement and stable with any type of capacitor as small as 1.0 μF . The NCV8535 also comes equipped with sense and noise reduction pins to increase the overall utility of the device. The NCV8535 offers reverse bias protection.

Features

- High Accuracy Over Line and Load ($\pm 0.9\%$ at 25°C)
- Ultra-Low Dropout Voltage at Full Load (260 mV typ.)
- No Minimum Output Current Required for Stability
- Low Noise (31 μVrms w/10 nF C_{nr} and 51 μVrms w/out C_{nr})
- Low Shutdown Current (0.07 μA)
- Reverse Bias Protected
- 2.9 V to 12 V Supply Range
- Thermal Shutdown Protection
- Current Limitation
- Requires Only 1.0 μF Output Capacitance for Stability
- Stable with Any Type of Capacitor (including MLCC)
- Available in 1.5 V, 1.8 V, 1.9 V, 2.5 V, 2.8 V, 2.85 V, 3.0 V, 3.3 V, 3.5 V, 5.0 V and Adjustable Output Voltages
- NCV Prefix for Automotive and Other Applications Requiring Unique Site and Control Change Requirements; AEC-Q100 Qualified and PPAP Capable
- These are Pb-Free Devices

Applications

- PCMCIA Card
- Cellular Phones
- Camcoders and Cameras
- Networking Systems, DSL/Cable Modems
- Cable Set-Top Box
- MP3/CD Players
- DSP Supply
- Displays and Monitors



ON Semiconductor®

www.onsemi.com



DFN10
CASE 485C



DFNW10
CASE 507AM

PIN CONFIGURATION

Fixed Version	Adj Version
Pin 1, 2. V_{out}	Pin 1, 2. V_{out}
3. Sense	3. Adj
4. GND	4. GND
5, 6. NC	5, 6. NC
7. NR	7. NR
8. \overline{SD}	8. \overline{SD}
9, 10. V_{in}	9, 10. V_{in}

MARKING DIAGRAM

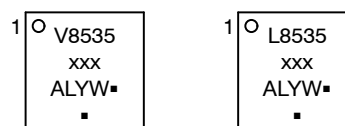

V8535 = Specific Device Code
L8535 = Specific Device Code
xxx = ADJ, 150, 180, 190, 250, 280, 285, 300, 330, 350, 500
A = Assembly Location
L = Wafer Lot
Y = Year
W = Work Week
▪ = Pb-Free Package

(Note: Microdot may be in either location)

ORDERING INFORMATION

See detailed ordering, marking and shipping information in the package dimensions section on page 21 of this data sheet.

NCV8535

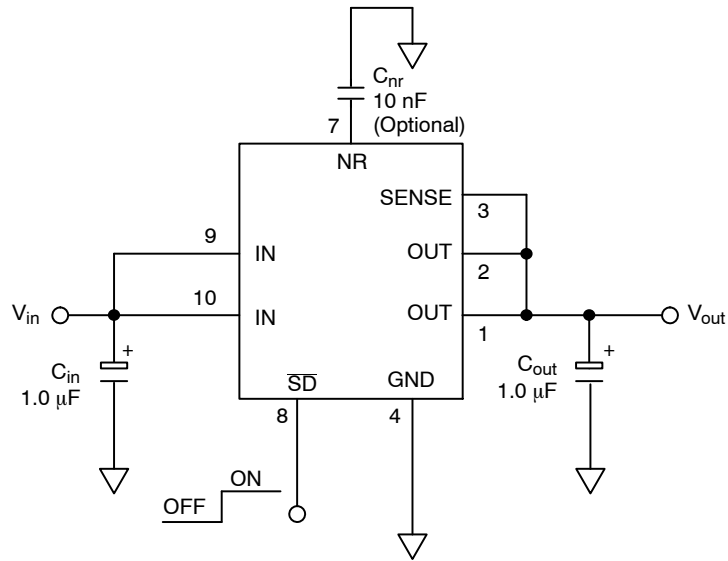

Figure 1. Typical Fixed Version Application Schematic

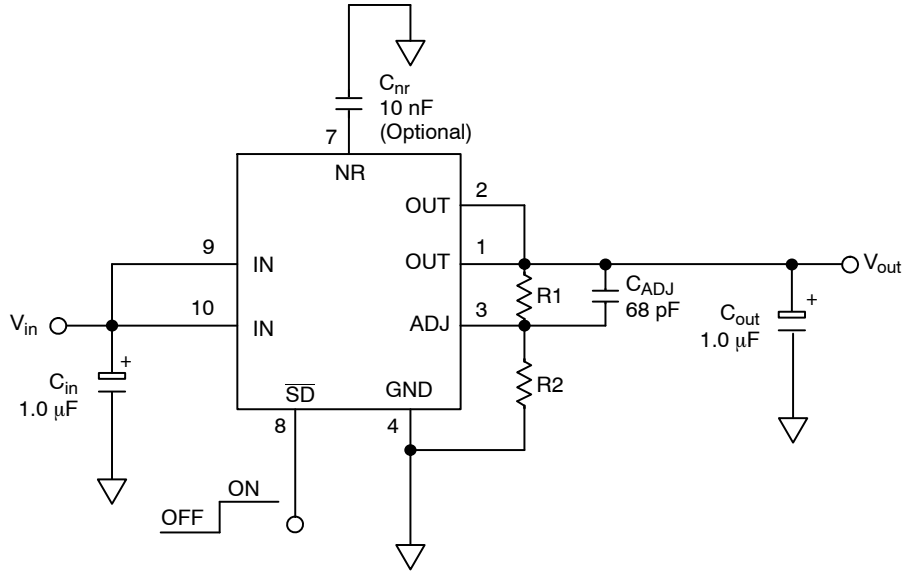

Figure 2. Typical Adjustable Version Application Schematic

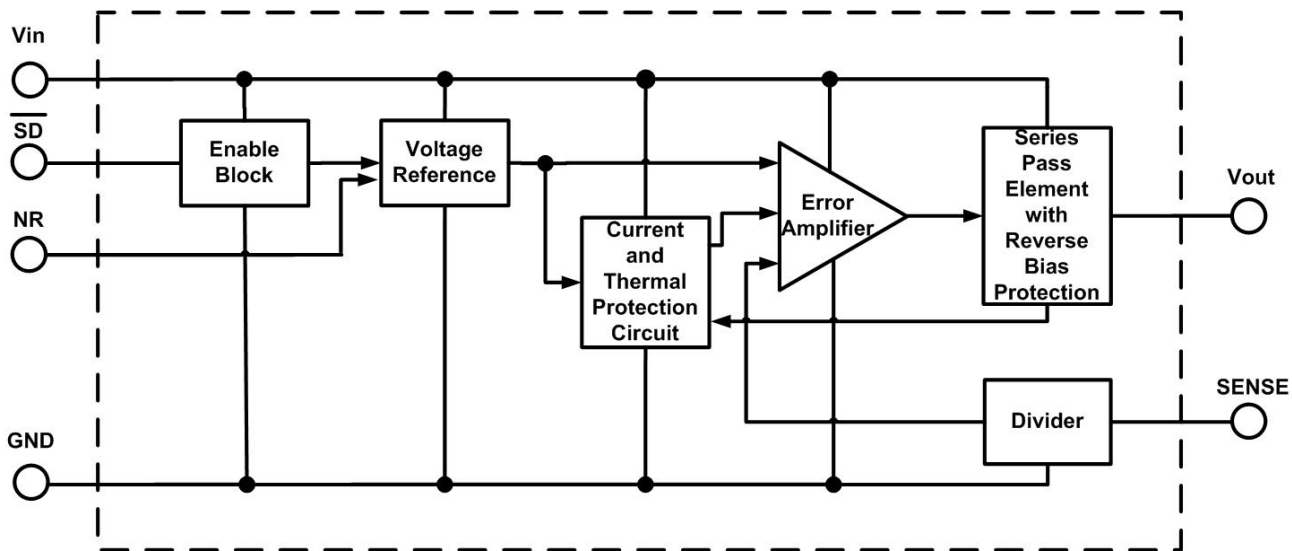

Figure 3. Block Diagram, Fixed Output Version

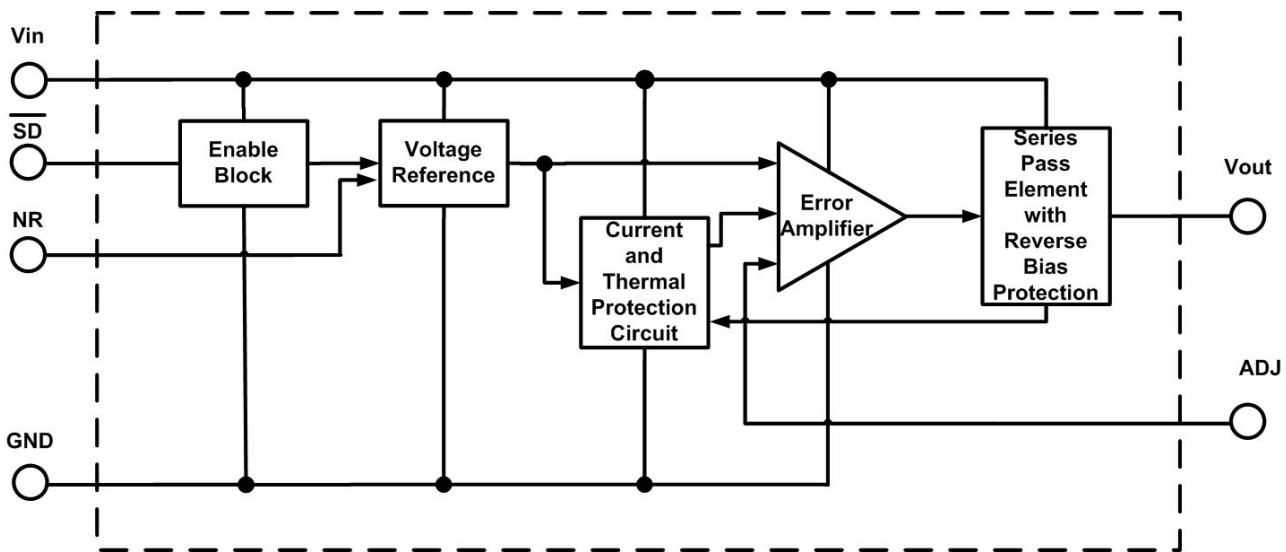

Figure 4. Block Diagram, Adjustable Output Version

NCV8535

PIN FUNCTION DESCRIPTION

Pin No.	Pin Name	Description
---------	----------	-------------

FIXED VERSION

1, 2	V _{out}	Regulated output voltage. Bypass to ground with C _{out} ≥ 1.0 μF.
3	SENSE	For output voltage sensing, connect to Pins 1 and 2.
4	GND	Power Supply Ground
7	NR	Noise Reduction Pin. This is an optional pin used to further reduce noise.
8	\overline{SD}	Shutdown pin. When not in use, this pin should be connected to the input pin.
9, 10	V _{in}	Power Supply Input Voltage
5, 6	NC	Not Connected
EPAD	EPAD	Exposed thermal pad should be connected to ground.

ADJUSTABLE VERSION

1, 2	V _{out}	Regulated output voltage. Bypass to ground with C _{out} ≥ 1.0 μF.
3	Adj	Adjustable pin; reference voltage = 1.25 V.
4	GND	Power Supply Ground
7	NR	Noise Reduction Pin. This is an optional pin used to further reduce noise.
8	\overline{SD}	Shutdown pin. When not in use, this pin should be connected to the input pin.
9, 10	V _{in}	Power Supply Input Voltage
5, 6	NC	Not Connected
EPAD	EPAD	Exposed thermal pad should be connected to ground.

MAXIMUM RATINGS

Rating	Symbol	Value	Unit
Input Voltage	V _{in}	-0.3 to +16	V
Output Voltage	V _{out}	-0.3 to V _{in} +0.3 or 10 V*	V
Shutdown Pin Voltage	V _{sh}	-0.3 to +16	V
Junction Temperature Range	T _J	-40 to +150	°C
Storage Temperature Range	T _{stg}	-55 to +150	°C

Stresses exceeding those listed in the Maximum Ratings table may damage the device. If any of these limits are exceeded, device functionality should not be assumed, damage may occur and reliability may be affected.

NOTE: This device series contains ESD protection and exceeds the following tests:

Human Body Model (HBM) tested per AEC-Q100-002 (EIA/JESD22-A114)

Machine Model (MM) tested per AEC-Q100-003 (EIA/JESD22-A115)

Charged Device Model (CDM) tested per EIA/JESD22-C101

*Which ever is less. Reverse bias protection feature valid only if V_{out} - V_{in} ≤ 7 V.

THERMAL CHARACTERISTICS

Characteristic	Test Conditions (Typical Value)		Unit
	Min Pad Board (Note 1)	1" Pad Board (Note 1)	
Junction-to-Air, θ _{JA}	215	66	°C/W
Junction-to-Pin, ψ _{JL2}	55	17	°C/W

1. As mounted on a 35 x 35 x 1.5 mm FR4 Substrate, with a single layer of a specified copper area of 2 oz (0.07 mm thick) copper traces and heat spreading area. JEDEC 51 specifications for a low and high conductivity test board recommend a 2 oz copper thickness. Test conditions are under natural convection or zero air flow.

NCV8535

ELECTRICAL CHARACTERISTICS – 5.0 V

($V_{out} = 5.0$ V typical, $V_{in} = 5.4$ V, $T_A = -40^{\circ}\text{C}$ to $+85^{\circ}\text{C}$, unless otherwise noted, Note 2.)

Characteristic	Symbol	Min	Typ	Max	Unit
Output Voltage (Accuracy) $V_{in} = 5.4$ V to 9.0 V, $I_{load} = 0.1$ mA to 500 mA, $T_A = 25^{\circ}\text{C}$	V_{out}	-0.9% 4.955	5.0	+0.9% 5.045	V
Output Voltage (Accuracy) $V_{in} = 5.4$ V to 9.0 V, $I_{load} = 0.1$ mA to 500 mA, $T_A = 0^{\circ}\text{C}$ to $+85^{\circ}\text{C}$	V_{out}	-1.4% 4.930	5.0	+1.4% 5.070	V
Output Voltage (Accuracy) $V_{in} = 5.4$ V to 9.0 V, $I_{load} = 0.1$ mA to 500 mA, $T_A = -40^{\circ}\text{C}$ to $+125^{\circ}\text{C}$	V_{out}	-1.5% 4.925	5.0	+1.5% 5.075	V
Line Regulation $V_{in} = 5.4$ V to 12 V, $I_{load} = 0.1$ mA	LineReg		0.04		mV/V
Load Regulation $V_{in} = 5.4$ V, $I_{load} = 0.1$ mA to 500 mA	LoadReg		0.04		mV/mA
Dropout Voltage (See App Note) $I_{load} = 500$ mA $I_{load} = 300$ mA $I_{load} = 50$ mA $I_{load} = 0.1$ mA	V_{DO}			340 230 110 10	mV
Peak Output Current (See Figure 16)	I_{pk}	500	700	830	mA
Short Output Current (See Figure 16)	I_{sc}			930	mA
Thermal Shutdown	T_J		160		$^{\circ}\text{C}$
Ground Current In Regulation $I_{load} = 500$ mA (Note 3) $I_{load} = 300$ mA (Note 3) $I_{load} = 50$ mA $I_{load} = 0.1$ mA In Dropout $V_{in} = 4.9$ V, $I_{load} = 0.1$ mA In Shutdown $S_D = 0$ V	I_{GND} I_{GNDsh}		9.0 4.6 0.8 – – 0.07	14 7.5 2.5 190 500 1.0	mA μA
Output Noise $C_{nr} = 0$ nF, $I_{load} = 500$ mA, $f = 10$ Hz to 100 kHz, $C_{out} = 10$ μF $C_{nr} = 10$ nF, $I_{load} = 500$ mA, $f = 10$ Hz to 100 kHz, $C_{out} = 10$ μF	V_{noise}		93 58		μVrms μVrms
Shutdown Threshold Voltage ON Threshold Voltage OFF		2.0		0.4	V V
S_D Input Current, $V_{SD} = 0$ V to 0.4 V or $V_{SD} = 2.0$ V to V_{in}	I_{SD}		0.07	1.0	μA
Output Current In Shutdown Mode, $V_{out} = 0$ V	I_{OSD}		0.07	1.0	μA
Reverse Bias Protection, Current Flowing from the Output Pin to GND ($V_{in} = 0$ V, $V_{out_forced} = 5.0$ V)	I_{OUTR}		10		μA

- Performance guaranteed over the operating temperature range by design and/or characterization, production tested at $T_J = T_A = 25^{\circ}\text{C}$. Low duty cycle pulse techniques are used during testing to maintain the junction temperature as close to ambient as possible.
- T_A must be greater than 0°C .

NCV8535

ELECTRICAL CHARACTERISTICS – 3.5 V

($V_{out} = 3.5$ V typical, $V_{in} = 3.9$ V, $T_A = -40^{\circ}\text{C}$ to $+85^{\circ}\text{C}$, unless otherwise noted, Note 4.)

Characteristic	Symbol	Min	Typ	Max	Unit
Output Voltage (Accuracy) $V_{in} = 3.9$ V to 7.5 V, $I_{load} = 0.1$ mA to 500 mA, $T_A = 25^{\circ}\text{C}$	V_{out}	-0.9% 3.469	3.5	+0.9% 3.532	V
Output Voltage (Accuracy) $V_{in} = 3.9$ V to 7.5 V, $I_{load} = 0.1$ mA to 500 mA, $T_A = 0^{\circ}\text{C}$ to $+85^{\circ}\text{C}$	V_{out}	-1.4% 3.451	3.5	+1.4% 3.549	V
Output Voltage (Accuracy) $V_{in} = 3.9$ V to 7.5 V, $I_{load} = 0.1$ mA to 500 mA, $T_A = -40^{\circ}\text{C}$ to $+125^{\circ}\text{C}$	V_{out}	-1.5% 3.448	3.5	+1.5% 3.553	V
Line Regulation $V_{in} = 3.9$ V to 12 V, $I_{load} = 0.1$ mA	LineReg		0.04		mV/V
Load Regulation $V_{in} = 3.9$ V, $I_{load} = 0.1$ mA to 500 mA	LoadReg		0.04		mV/mA
Dropout Voltage (See App Note) $I_{load} = 500$ mA $I_{load} = 300$ mA $I_{load} = 50$ mA $I_{load} = 0.1$ mA	V_{DO}			340 230 110 10	mV
Peak Output Current (See Figure 16)	I_{pk}	500	700	800	mA
Short Output Current (See Figure 16)	I_{sc}			900	mA
Thermal Shutdown	T_J		160		$^{\circ}\text{C}$
Ground Current In Regulation $I_{load} = 500$ mA (Note 5) $I_{load} = 300$ mA $I_{load} = 50$ mA $I_{load} = 0.1$ mA In Dropout $V_{in} = 3.4$ V, $I_{load} = 0.1$ mA In Shutdown $S_D = 0$ V	I_{GND} I_{GNDsh}		9.0 4.6 0.8 – – 0.07	14 7.5 2.5 190 500 1.0	mA μA
Output Noise $C_{nr} = 0$ nF, $I_{load} = 500$ mA, $f = 10$ Hz to 100 kHz, $C_{out} = 10$ μF $C_{nr} = 10$ nF, $I_{load} = 500$ mA, $f = 10$ Hz to 100 kHz, $C_{out} = 10$ μF	V_{noise}		68 47		μVrms μVrms
Shutdown Threshold Voltage ON Threshold Voltage OFF		2.0		0.4	V V
S_D Input Current, $V_{SD} = 0$ V to 0.4 V or $V_{SD} = 2.0$ V to V_{in}	I_{SD}		0.07	1.0	μA
Output Current In Shutdown Mode, $V_{out} = 0$ V	I_{OSD}		0.07	1.0	μA
Reverse Bias Protection, Current Flowing from the Output Pin to GND ($V_{in} = 0$ V, $V_{out_forced} = 3.5$ V)	I_{OUTR}		10		μA

- Performance guaranteed over the operating temperature range by design and/or characterization, production tested at $T_J = T_A = 25^{\circ}\text{C}$. Low duty cycle pulse techniques are used during testing to maintain the junction temperature as close to ambient as possible.
- T_A must be greater than 0°C .

NCV8535

ELECTRICAL CHARACTERISTICS – 3.3 V

($V_{out} = 3.3$ V typical, $V_{in} = 3.7$ V, $T_A = -40^{\circ}\text{C}$ to $+85^{\circ}\text{C}$, unless otherwise noted, Note 6.)

Characteristic	Symbol	Min	Typ	Max	Unit
Output Voltage (Accuracy) $V_{in} = 3.7$ V to 7.3 V, $I_{load} = 0.1$ mA to 500 mA, $T_A = 25^{\circ}\text{C}$	V_{out}	-0.9% 3.270	3.3	+0.9% 3.330	V
Output Voltage (Accuracy) $V_{in} = 3.7$ V to 7.3 V, $I_{load} = 0.1$ mA to 500 mA, $T_A = 0^{\circ}\text{C}$ to $+85^{\circ}\text{C}$	V_{out}	-1.4% 3.254	3.3	+1.4% 3.346	V
Output Voltage (Accuracy) $V_{in} = 3.7$ V to 7.3 V, $I_{load} = 0.1$ mA to 500 mA, $T_A = -40^{\circ}\text{C}$ to $+125^{\circ}\text{C}$	V_{out}	-1.5% 3.250	3.3	+1.5% 3.350	V
Line Regulation $V_{in} = 3.7$ V to 12 V, $I_{load} = 0.1$ mA	LineReg		0.04		mV/V
Load Regulation $V_{in} = 3.7$ V, $I_{load} = 0.1$ mA to 500 mA	LoadReg		0.04		mV/mA
Dropout Voltage (See App Note) $I_{load} = 500$ mA $I_{load} = 300$ mA $I_{load} = 50$ mA $I_{load} = 0.1$ mA	V_{DO}			340 230 110 10	mV
Peak Output Current (See Figure 16)	I_{pk}	500	700	800	mA
Short Output Current (See Figure 16)	I_{sc}			900	mA
Thermal Shutdown	T_J		160		$^{\circ}\text{C}$
Ground Current In Regulation $I_{load} = 500$ mA (Note 7) $I_{load} = 300$ mA $I_{load} = 50$ mA $I_{load} = 0.1$ mA In Dropout $V_{in} = 3.2$ V, $I_{load} = 0.1$ mA In Shutdown $S_D = 0$ V	I_{GND}		9.0 4.6 0.8 –	14 7.5 2.5 190	mA μA
Output Noise $C_{nr} = 0$ nF, $I_{load} = 500$ mA, $f = 10$ Hz to 100 kHz, $C_{out} = 10$ μF $C_{nr} = 10$ nF, $I_{load} = 500$ mA, $f = 10$ Hz to 100 kHz, $C_{out} = 10$ μF	V_{noise}		69 46		μVrms μVrms
Shutdown Threshold Voltage ON Threshold Voltage OFF		2.0		0.4	V V
S_D Input Current, $V_{SD} = 0$ V to 0.4 V or $V_{SD} = 2.0$ V to V_{in}	I_{SD}		0.07	1.0	μA
Output Current In Shutdown Mode, $V_{out} = 0$ V	I_{OSD}		0.07	1.0	μA
Reverse Bias Protection, Current Flowing from the Output Pin to GND ($V_{in} = 0$ V, $V_{out_forced} = 3.3$ V)	I_{OUTR}		10		μA

6. Performance guaranteed over the operating temperature range by design and/or characterization, production tested at $T_J = T_A = 25^{\circ}\text{C}$. Low duty cycle pulse techniques are used during testing to maintain the junction temperature as close to ambient as possible.

7. T_A must be greater than 0°C .

NCV8535

ELECTRICAL CHARACTERISTICS – 3.0 V

($V_{out} = 3.0$ V typical, $V_{in} = 3.4$ V, $T_A = -40^{\circ}\text{C}$ to $+85^{\circ}\text{C}$, unless otherwise noted, Note 8.)

Characteristic	Symbol	Min	Typ	Max	Unit
Output Voltage (Accuracy) $V_{in} = 3.4$ V to 7.0 V, $I_{load} = 0.1$ mA to 500 mA, $T_A = 25^{\circ}\text{C}$	V_{out}	-0.9% 2.973	3.0	+0.9% 3.027	V
Output Voltage (Accuracy) $V_{in} = 3.4$ V to 7.0 V, $I_{load} = 0.1$ mA to 500 mA, $T_A = 0^{\circ}\text{C}$ to $+85^{\circ}\text{C}$	V_{out}	-1.4% 2.958	3.0	+1.4% 3.042	V
Output Voltage (Accuracy) $V_{in} = 3.4$ V to 7.0 V, $I_{load} = 0.1$ mA to 500 mA, $T_A = -40^{\circ}\text{C}$ to $+125^{\circ}\text{C}$	V_{out}	-1.5% 2.955	3.0	+1.5% 3.045	V
Line Regulation $V_{in} = 3.4$ V to 12 V, $I_{load} = 0.1$ mA	LineReg		0.04		mV/V
Load Regulation $V_{in} = 3.4$ V, $I_{load} = 0.1$ mA to 500 mA	LoadReg		0.04		mV/mA
Dropout Voltage (See App Note) $I_{load} = 500$ mA $I_{load} = 300$ mA $I_{load} = 50$ mA $I_{load} = 0.1$ mA	V_{DO}			340 230 110 10	mV
Peak Output Current (See Figure 16)	I_{pk}	500	700	800	mA
Short Output Current (See Figure 16)	I_{sc}			900	mA
Thermal Shutdown	T_J		160		$^{\circ}\text{C}$
Ground Current In Regulation $I_{load} = 500$ mA (Note 9) $I_{load} = 300$ mA $I_{load} = 50$ mA $I_{load} = 0.1$ mA In Dropout $V_{in} = 2.9$ V, $I_{load} = 0.1$ mA In Shutdown $S_D = 0$ V	I_{GND} I_{GNDsh}		9.0 4.6 0.8 – – 0.07	14 7.5 2.5 190 500 1.0	mA μA
Output Noise $C_{nr} = 0$ nF, $I_{load} = 500$ mA, $f = 10$ Hz to 100 kHz, $C_{out} = 10$ μF $C_{nr} = 10$ nF, $I_{load} = 500$ mA, $f = 10$ Hz to 100 kHz, $C_{out} = 10$ μF	V_{noise}		56 37		μVrms μVrms
Shutdown Threshold Voltage ON Threshold Voltage OFF		2.0		0.4	V V
S_D Input Current, $V_{SD} = 0$ V to 0.4 V or $V_{SD} = 2.0$ V to V_{in}	I_{SD}		0.07	1.0	μA
Output Current In Shutdown Mode, $V_{out} = 0$ V	I_{OSD}		0.07	1.0	μA
Reverse Bias Protection, Current Flowing from the Output Pin to GND ($V_{in} = 0$ V, $V_{out_forced} = 3.0$ V)	I_{OUTR}		10		μA

8. Performance guaranteed over the operating temperature range by design and/or characterization, production tested at $T_J = T_A = 25^{\circ}\text{C}$. Low duty cycle pulse techniques are used during testing to maintain the junction temperature as close to ambient as possible.

9. T_A must be greater than 0°C .

ELECTRICAL CHARACTERISTICS – 2.85 V

($V_{out} = 2.85$ V typical, $V_{in} = 3.25$ V, $T_A = -40^{\circ}\text{C}$ to $+85^{\circ}\text{C}$, unless otherwise noted, Note 10)

Characteristic	Symbol	Min	Typ	Max	Unit
Output Voltage (Accuracy) $V_{in} = 3.25$ V to 6.85 V, $I_{load} = 0.1$ mA to 500 mA, $T_A = 25^{\circ}\text{C}$	V_{out}	-0.9% 2.824	2.85	+0.9% 2.876	V
Output Voltage (Accuracy) $V_{in} = 3.25$ V to 6.85 V, $I_{load} = 0.1$ mA to 500 mA, $T_A = 0^{\circ}\text{C}$ to $+85^{\circ}\text{C}$	V_{out}	-1.4% 2.810	2.85	+1.4% 2.890	V
Output Voltage (Accuracy) (Note 11) $V_{in} = 3.25$ V to 6.85 V, $I_{load} = 0.1$ mA to 500 mA, $T_A = -40^{\circ}\text{C}$ to $+125^{\circ}\text{C}$	V_{out}	-1.5% 2.807	2.85	+1.5% 2.893	V
Line Regulation $V_{in} = 3.25$ V to 12 V, $I_{load} = 0.1$ mA	LineReg		0.04		mV/V
Load Regulation $V_{in} = 3.25$ V, $I_{load} = 0.1$ mA to 500 mA	LoadReg		0.04		mV/mA
Dropout Voltage (See App Note) $I_{load} = 500$ mA $I_{load} = 300$ mA $I_{load} = 50$ mA $I_{load} = 0.1$ mA	V_{DO}			340 230 110 10	mV
Peak Output Current (See Figure 16)	I_{pk}	500	700	800	mA
Short Output Current (See Figure 16)	I_{sc}			900	mA
Thermal Shutdown	T_J		160		$^{\circ}\text{C}$
Ground Current In Regulation $I_{load} = 500$ mA (Note 12) $I_{load} = 300$ mA $I_{load} = 50$ mA $I_{load} = 0.1$ mA In Dropout $V_{in} = 2.75$ V, $I_{load} = 0.1$ mA In Shutdown $S_D = 0$ V	I_{GND}		9.0 4.6 0.8 –	14 7.5 2.5 190	mA μA
Output Noise $C_{nr} = 0$ nF, $I_{load} = 500$ mA, $f = 10$ Hz to 100 kHz, $C_{out} = 10$ μF $C_{nr} = 10$ nF, $I_{load} = 500$ mA, $f = 10$ Hz to 100 kHz, $C_{out} = 10$ μF	V_{noise}		61 40		μVrms μVrms
Shutdown Threshold Voltage ON Threshold Voltage OFF		2.0		0.4	V V
S_D Input Current, $V_{SD} = 0$ V to 0.4 V or $V_{SD} = 2.0$ V to V_{in}	I_{SD}		0.07	1.0	μA
Output Current In Shutdown Mode, $V_{out} = 0$ V	I_{OSD}		0.07	1.0	μA
Reverse Bias Protection, Current Flowing from the Output Pin to GND ($V_{in} = 0$ V, $V_{out_forced} = 2.85$ V)	I_{OUTR}		10		μA

10. Performance guaranteed over the operating temperature range by design and/or characterization, production tested at $T_J = T_A = 25^{\circ}\text{C}$. Low duty cycle pulse techniques are used during testing to maintain the junction temperature as close to ambient as possible.

11. For output current capability for $T_A < 0^{\circ}\text{C}$, please refer to Figure 18.

12. T_A must be greater than 0°C .

ELECTRICAL CHARACTERISTICS – 2.8 V

($V_{out} = 2.8\text{ V}$ typical, $V_{in} = 3.2\text{ V}$, $T_A = -40^\circ\text{C}$ to $+85^\circ\text{C}$, unless otherwise noted, Note 13.)

Characteristic	Symbol	Min	Typ	Max	Unit
Output Voltage (Accuracy) $V_{in} = 3.2\text{ V}$ to 6.8 V , $I_{load} = 0.1\text{ mA}$ to 500 mA , $T_A = 25^\circ\text{C}$	V_{out}	-0.9% 2.774	2.8	+0.9% 2.826	V
Output Voltage (Accuracy) $V_{in} = 3.2\text{ V}$ to 6.8 V , $I_{load} = 0.1\text{ mA}$ to 500 mA , $T_A = 0^\circ\text{C}$ to $+85^\circ\text{C}$	V_{out}	-1.4% 2.760	2.8	+1.4% 2.840	V
Output Voltage (Accuracy) (Note 14) $V_{in} = 3.2\text{ V}$ to 6.8 V , $I_{load} = 0.1\text{ mA}$ to 500 mA , $T_A = -40^\circ\text{C}$ to $+125^\circ\text{C}$	V_{out}	-1.5% 2.758	2.8	+1.5% 2.842	V
Line Regulation $V_{in} = 3.2\text{ V}$ to 12 V , $I_{load} = 0.1\text{ mA}$	LineReg		0.04		mV/V
Load Regulation $V_{in} = 3.2\text{ V}$, $I_{load} = 0.1\text{ mA}$ to 500 mA	LoadReg		0.04		mV/mA
Dropout Voltage (See App Note) $I_{load} = 500\text{ mA}$ $I_{load} = 300\text{ mA}$ $I_{load} = 50\text{ mA}$ $I_{load} = 0.1\text{ mA}$	V_{DO}			340 230 110 10	mV
Peak Output Current (See Figure 16)	I_{pk}	500	700	800	mA
Short Output Current (See Figure 16)	I_{sc}			900	mA
Thermal Shutdown	T_J		160		$^\circ\text{C}$
Ground Current In Regulation $I_{load} = 500\text{ mA}$ (Note 15) $I_{load} = 300\text{ mA}$ (Note 15) $I_{load} = 50\text{ mA}$ $I_{load} = 0.1\text{ mA}$ In Dropout $V_{in} = 2.7\text{ V}$, $I_{load} = 0.1\text{ mA}$ In Shutdown $S_D = 0\text{ V}$	I_{GND} I_{GNDsh}		9.0 4.6 0.8 – – 0.07	14 7.5 2.5 190 500 1.0	mA μA
Output Noise $C_{nr} = 0\text{ nF}$, $I_{load} = 500\text{ mA}$, $f = 10\text{ Hz}$ to 100 kHz , $C_{out} = 10\text{ }\mu\text{F}$ $C_{nr} = 10\text{ nF}$, $I_{load} = 500\text{ mA}$, $f = 10\text{ Hz}$ to 100 kHz , $C_{out} = 10\text{ }\mu\text{F}$	V_{noise}		52 36		μVrms μVrms
Shutdown Threshold Voltage ON Threshold Voltage OFF		2.0		0.4	V V
S_D Input Current, $V_{SD} = 0\text{ V}$ to 0.4 V or $V_{SD} = 2.0\text{ V}$ to V_{in}	I_{SD}		0.07	1.0	μA
Output Current In Shutdown Mode, $V_{out} = 0\text{ V}$	I_{OSD}		0.07	1.0	μA
Reverse Bias Protection, Current Flowing from the Output Pin to GND ($V_{in} = 0\text{ V}$, $V_{out_forced} = 2.8\text{ V}$)	I_{OUTR}		10		μA

13. Performance guaranteed over the operating temperature range by design and/or characterization, production tested at $T_J = T_A = 25^\circ\text{C}$. Low duty cycle pulse techniques are used during testing to maintain the junction temperature as close to ambient as possible.

14. For output current capability for $T_A < 0^\circ\text{C}$, please refer to Figure 19.

15. T_A must be greater than 0°C .

ELECTRICAL CHARACTERISTICS – 2.5 V

($V_{out} = 2.5\text{ V}$ typical, $V_{in} = 2.9\text{ V}$, $T_A = -40^\circ\text{C}$ to $+85^\circ\text{C}$, unless otherwise noted, Note 16.)

Characteristic	Symbol	Min	Typ	Max	Unit
Output Voltage (Accuracy) $V_{in} = 2.9\text{ V}$ to 6.5 V , $I_{load} = 0.1\text{ mA}$ to 500 mA , $T_A = 25^\circ\text{C}$	V_{out}	-0.9% 2.477	2.5	+0.9% 2.523	V
Output Voltage (Accuracy) $V_{in} = 2.9\text{ V}$ to 6.5 V , $I_{load} = 0.1\text{ mA}$ to 500 mA , $T_A = 0^\circ\text{C}$ to $+85^\circ\text{C}$	V_{out}	-1.4% 2.465	2.5	+1.4% 2.535	V
Output Voltage (Accuracy), (Note 17) $V_{in} = 2.9\text{ V}$ to 6.5 V , $I_{load} = 0.1\text{ mA}$ to 500 mA , $T_A = -40^\circ\text{C}$ to $+125^\circ\text{C}$	V_{out}	-1.5% 2.462	2.5	+1.5% 2.538	V
Line Regulation $V_{in} = 2.9\text{ V}$ to 12 V , $I_{load} = 0.1\text{ mA}$	LineReg		0.04		mV/V
Load Regulation $V_{in} = 2.9\text{ V}$, $I_{load} = 0.1\text{ mA}$ to 500 mA	LoadReg		0.04		mV/mA
Dropout Voltage (See App Note) $I_{load} = 500\text{ mA}$ (Note 18) $I_{load} = 300\text{ mA}$ (Note 18) $I_{load} = 50\text{ mA}$ $I_{load} = 0.1\text{ mA}$	V_{DO}			340 230 110 10	mV
Peak Output Current (See Figure 16)	I_{pk}	500	700	800	mA
Short Output Current (See Figure 16)	I_{sc}			900	mA
Thermal Shutdown	T_J		160		$^\circ\text{C}$
Ground Current In Regulation $I_{load} = 500\text{ mA}$ (Note 18) $I_{load} = 300\text{ mA}$ (Note 18) $I_{load} = 50\text{ mA}$ $I_{load} = 0.1\text{ mA}$ In Dropout $V_{in} = 2.4\text{ V}$, $I_{load} = 0.1\text{ mA}$ In Shutdown $S_D = 0\text{ V}$	I_{GND} I_{GNDsh}		9.0 4.6 0.8 –	14 7.5 2.5 190 500 1.0	mA μA
Output Noise $C_{nr} = 0\text{ nF}$, $I_{load} = 500\text{ mA}$, $f = 10\text{ Hz}$ to 100 kHz , $C_{out} = 10\text{ }\mu\text{F}$ $C_{nr} = 10\text{ nF}$, $I_{load} = 500\text{ mA}$, $f = 10\text{ Hz}$ to 100 kHz , $C_{out} = 10\text{ }\mu\text{F}$	V_{noise}		56 35		μVrms μVrms
Shutdown Threshold Voltage ON Threshold Voltage OFF		2.0		0.4	V V
S_D Input Current, $V_{SD} = 0\text{ V}$ to 0.4 V or $V_{SD} = 2.0\text{ V}$ to V_{in}	I_{SD}		0.07	1.0	μA
Output Current In Shutdown Mode, $V_{out} = 0\text{ V}$	I_{OSD}		0.07	1.0	μA
Reverse Bias Protection, Current Flowing from the Output Pin to GND ($V_{in} = 0\text{ V}$, $V_{out_forced} = 2.5\text{ V}$)	I_{OUTR}		10		μA

16. Performance guaranteed over the operating temperature range by design and/or characterization, production tested at $T_J = T_A = 25^\circ\text{C}$. Low duty cycle pulse techniques are used during testing to maintain the junction temperature as close to ambient as possible.

17. For output current capability for $T_A < 0^\circ\text{C}$, please refer to Figure 20.

18. T_A must be greater than 0°C .

ELECTRICAL CHARACTERISTICS – 1.9 V

($V_{out} = 1.9\text{ V}$ typical, $V_{in} = 2.9\text{ V}$, $T_A = -40^\circ\text{C}$ to $+85^\circ\text{C}$, unless otherwise noted, Note 19.)

Characteristic	Symbol	Min	Typ	Max	Unit
Output Voltage (Accuracy) $V_{in} = 2.9\text{ V}$ to 5.9 V , $I_{load} = 0.1\text{ mA}$ to 500 mA , $T_A = 25^\circ\text{C}$	V_{out}	-0.9% 1.883	1.9	+0.9% 1.917	V
Output Voltage (Accuracy) $V_{in} = 2.9\text{ V}$ to 5.9 V , $I_{load} = 0.1\text{ mA}$ to 500 mA , $T_A = 0^\circ\text{C}$ to $+85^\circ\text{C}$	V_{out}	-1.4% 1.873	1.9	+1.4% 1.927	V
Output Voltage (Accuracy), (Note 20) $V_{in} = 2.9\text{ V}$ to 5.9 V , $I_{load} = 0.1\text{ mA}$ to 500 mA , $T_A = -40^\circ\text{C}$ to $+125^\circ\text{C}$	V_{out}	-1.5% 1.872	1.9	+1.5% 1.929	V
Line Regulation $V_{in} = 2.9\text{ V}$ to 12 V , $I_{load} = 0.1\text{ mA}$	LineReg		0.04		mV/V
Load Regulation $V_{in} = 2.9\text{ V}$, $I_{load} = 0.1\text{ mA}$ to 500 mA	LoadReg		0.04		mV/mA
Dropout Voltage (See App Note) $I_{load} = 500\text{ mA}$ (Notes 21, 22) $I_{load} = 300\text{ mA}$ (Notes 21, 22) $I_{load} = 50\text{ mA}$ (Notes 21, 22)	V_{DO}		367 156 90	1030 1030 1030	mV
Peak Output Current (See Figure 16)	I_{pk}	500	700	800	mA
Short Output Current (See Figure 16)	I_{sc}			900	mA
Thermal Shutdown	T_J		160		$^\circ\text{C}$
Ground Current In Regulation $I_{load} = 500\text{ mA}$ (Note 21) $I_{load} = 300\text{ mA}$ (Note 21) $I_{load} = 50\text{ mA}$ $I_{load} = 0.1\text{ mA}$ In Dropout $V_{in} = 2.2\text{ V}$, $I_{load} = 0.1\text{ mA}$ In Shutdown $S_D = 0\text{ V}$	I_{GND} I_{GNDsh}		9.0 4.6 0.8 –	14 7.5 2.5 190 500	mA μA
Output Noise $C_{nr} = 0\text{ nF}$, $I_{load} = 500\text{ mA}$, $f = 10\text{ Hz}$ to 100 kHz , $C_{out} = 10\text{ }\mu\text{F}$ $C_{nr} = 10\text{ nF}$, $I_{load} = 500\text{ mA}$, $f = 10\text{ Hz}$ to 100 kHz , $C_{out} = 10\text{ }\mu\text{F}$	V_{noise}		53 33		μVrms μVrms
Shutdown Threshold Voltage ON Threshold Voltage OFF		2.0		0.4	V V
S_D Input Current, $V_{SD} = 0\text{ V}$ to 0.4 V or $V_{SD} = 2.0\text{ V}$ to V_{in}	I_{SD}		0.07	1.0	μA
Output Current In Shutdown Mode, $V_{out} = 0\text{ V}$	I_{OSD}		0.07	1.0	μA
Reverse Bias Protection, Current Flowing from the Output Pin to GND ($V_{in} = 0\text{ V}$, $V_{out_forced} = 1.9\text{ V}$)	I_{OUTR}		10		μA

19. Performance guaranteed over the operating temperature range by design and/or characterization, production tested at $T_J = T_A = 25^\circ\text{C}$. Low duty cycle pulse techniques are used during testing to maintain the junction temperature as close to ambient as possible.

20. For output current capability for $T_A < 0^\circ\text{C}$, please refer to Figure 21.

21. T_A must be greater than 0°C .

22. Maximum dropout voltage is limited by minimum input voltage $V_{in} = 2.9\text{ V}$ recommended for guaranteed operation.

ELECTRICAL CHARACTERISTICS – 1.8 V

($V_{out} = 1.8\text{ V}$ typical, $V_{in} = 2.9\text{ V}$, $T_A = -40^\circ\text{C}$ to $+85^\circ\text{C}$, unless otherwise noted, Note 23.)

Characteristic	Symbol	Min	Typ	Max	Unit
Output Voltage (Accuracy) $V_{in} = 2.9\text{ V}$ to 5.8 V , $I_{load} = 0.1\text{ mA}$ to 500 mA , $T_A = 25^\circ\text{C}$	V_{out}	-0.9% 1.783	1.8	+0.9% 1.817	V
Output Voltage (Accuracy) $V_{in} = 2.9\text{ V}$ to 5.8 V , $I_{load} = 0.1\text{ mA}$ to 500 mA , $T_A = 0^\circ\text{C}$ to $+85^\circ\text{C}$	V_{out}	-1.4% 1.774	1.8	+1.4% 1.826	V
Output Voltage (Accuracy), (Note 24) $V_{in} = 2.9\text{ V}$ to 5.8 V , $I_{load} = 0.1\text{ mA}$ to 500 mA , $T_A = -40^\circ\text{C}$ to $+125^\circ\text{C}$	V_{out}	-1.5% 1.773	1.8	+1.5% 1.827	V
Line Regulation $V_{in} = 2.9\text{ V}$ to 12 V , $I_{load} = 0.1\text{ mA}$	LineReg		0.04		mV/V
Load Regulation $V_{in} = 2.9\text{ V}$, $I_{load} = 0.1\text{ mA}$ to 500 mA	LoadReg		0.04		mV/mA
Dropout Voltage (See App Note) $I_{load} = 500\text{ mA}$ (Notes 25, 26) $I_{load} = 300\text{ mA}$ (Notes 25, 26) $I_{load} = 50\text{ mA}$ (Notes 25, 26)	V_{DO}		620 230 95	1130 1130 1130	mV
Peak Output Current (See Figure 16)	I_{pk}	500	700	830	mA
Short Output Current (See Figure 16)	I_{sc}			900	mA
Thermal Shutdown	T_J		160		$^\circ\text{C}$
Ground Current In Regulation $I_{load} = 500\text{ mA}$ (Note 25) $I_{load} = 300\text{ mA}$ (Note 25) $I_{load} = 50\text{ mA}$ $I_{load} = 0.1\text{ mA}$ In Dropout $V_{in} = 2.2\text{ V}$, $I_{load} = 0.1\text{ mA}$ In Shutdown $S_D = 0\text{ V}$	I_{GND} I_{GNDsh}		9.0 4.6 0.8 –	14 7.5 2.5 190 500	mA μA
Output Noise $C_{nr} = 0\text{ nF}$, $I_{load} = 500\text{ mA}$, $f = 10\text{ Hz}$ to 100 kHz , $C_{out} = 10\text{ }\mu\text{F}$ $C_{nr} = 10\text{ nF}$, $I_{load} = 500\text{ mA}$, $f = 10\text{ Hz}$ to 100 kHz , $C_{out} = 10\text{ }\mu\text{F}$	V_{noise}		52 33		μVrms μVrms
Shutdown Threshold Voltage ON Threshold Voltage OFF		2.0		0.4	V V
S_D Input Current, $V_{SD} = 0\text{ V}$ to 0.4 V or $V_{SD} = 2.0\text{ V}$ to V_{in}	I_{SD}		0.07	1.0	μA
Output Current In Shutdown Mode, $V_{out} = 0\text{ V}$	I_{OSD}		0.07	1.0	μA
Reverse Bias Protection, Current Flowing from the Output Pin to GND ($V_{in} = 0\text{ V}$, $V_{out_forced} = 1.8\text{ V}$)	I_{OUTR}		10		μA

23. Performance guaranteed over the operating temperature range by design and/or characterization, production tested at $T_J = T_A = 25^\circ\text{C}$. Low duty cycle pulse techniques are used during testing to maintain the junction temperature as close to ambient as possible.

24. For output current capability for $T_A < 0^\circ\text{C}$, please refer to Figure 21.

25. T_A must be greater than 0°C .

26. Maximum dropout voltage is limited by minimum input voltage $V_{in} = 2.9\text{ V}$ recommended for guaranteed operation.

ELECTRICAL CHARACTERISTICS – 1.5 V

($V_{out} = 1.5\text{ V}$ typical, $V_{in} = 2.9\text{ V}$, $T_A = -40^\circ\text{C}$ to $+85^\circ\text{C}$, unless otherwise noted, Note 27.)

Characteristic	Symbol	Min	Typ	Max	Unit
Output Voltage (Accuracy) $V_{in} = 2.9\text{ V}$ to 5.5 V , $I_{load} = 0.1\text{ mA}$ to 500 mA , $T_A = 25^\circ\text{C}$	V_{out}	-0.9% 1.486	1.5	+0.9% 1.514	V
Output Voltage (Accuracy) $V_{in} = 2.9\text{ V}$ to 5.5 V , $I_{load} = 0.1\text{ mA}$ to 500 mA , $T_A = 0^\circ\text{C}$ to $+85^\circ\text{C}$	V_{out}	-1.4% 1.479	1.5	+1.4% 1.521	V
Output Voltage (Accuracy), (Note 28) $V_{in} = 2.9\text{ V}$ to 5.5 V , $I_{load} = 0.1\text{ mA}$ to 500 mA , $T_A = -40^\circ\text{C}$ to $+125^\circ\text{C}$	V_{out}	-1.5% 1.477	1.5	+1.5% 1.523	V
Line Regulation $V_{in} = 2.9\text{ V}$ to 12 V , $I_{load} = 0.1\text{ mA}$	LineReg		0.04		mV/V
Load Regulation $V_{in} = 2.9\text{ V}$, $I_{load} = 0.1\text{ mA}$ to 500 mA	LoadReg		0.04		mV/mA
Dropout Voltage (See App Note) $I_{load} = 500\text{ mA}$ (Notes 29, 30) $I_{load} = 300\text{ mA}$ (Notes 29, 30) $I_{load} = 50\text{ mA}$ (Notes 29, 30)	V_{DO}		940 500 350	1430 1430 1430	mV
Peak Output Current (See Figure 16)	I_{pk}	500	700	860	mA
Short Output Current (See Figure 16)	I_{sc}			900	mA
Thermal Shutdown	T_J		160		$^\circ\text{C}$
Ground Current In Regulation $I_{load} = 500\text{ mA}$ (Note 29) $I_{load} = 300\text{ mA}$ (Note 29) $I_{load} = 50\text{ mA}$ $I_{load} = 0.1\text{ mA}$ In Dropout $V_{in} = 2.2\text{ V}$, $I_{load} = 0.1\text{ mA}$ In Shutdown $S_D = 0\text{ V}$	I_{GND} I_{GNDsh}		9.0 4.6 0.8 –	14 7.5 2.5 190 500	mA μA
Output Noise $C_{nr} = 0\text{ nF}$, $I_{load} = 500\text{ mA}$, $f = 10\text{ Hz}$ to 100 kHz , $C_{out} = 10\text{ }\mu\text{F}$ $C_{nr} = 10\text{ nF}$, $I_{load} = 500\text{ mA}$, $f = 10\text{ Hz}$ to 100 kHz , $C_{out} = 10\text{ }\mu\text{F}$	V_{noise}		51 31		μVrms μVrms
Shutdown Threshold Voltage ON Threshold Voltage OFF		2.0		0.4	V V
S_D Input Current, $V_{SD} = 0\text{ V}$ to 0.4 V or $V_{SD} = 2.0\text{ V}$ to V_{in}	I_{SD}		0.07	1.0	μA
Output Current In Shutdown Mode, $V_{out} = 0\text{ V}$	I_{OSD}		0.07	1.0	μA
Reverse Bias Protection, Current Flowing from the Output Pin to GND ($V_{in} = 0\text{ V}$, $V_{out_forced} = 1.5\text{ V}$)	I_{OUTR}		10		μA

27. Performance guaranteed over the operating temperature range by design and/or characterization, production tested at $T_J = T_A = 25^\circ\text{C}$. Low duty cycle pulse techniques are used during testing to maintain the junction temperature as close to ambient as possible.

28. For output current capability for $T_A < 0^\circ\text{C}$, please refer to Figure 22.

29. T_A must be greater than 0°C .

30. Maximum dropout voltage is limited by minimum input voltage $V_{in} = 2.9\text{ V}$ recommended for guaranteed operation.

NCV8535

ELECTRICAL CHARACTERISTICS – Adjustable

($V_{out} = 1.25$ V typical, $V_{in} = 2.9$ V, $T_A = -40^{\circ}\text{C}$ to $+85^{\circ}\text{C}$, unless otherwise noted, Note 31)

Characteristic	Symbol	Min	Typ	Max	Unit
Reference Voltage (Accuracy) $V_{in} = 2.9$ V to $V_{out} + 4.0$ V, $I_{load} = 0.1$ mA to 500 mA, $T_A = 25^{\circ}\text{C}$	V_{ref}	-0.9% 1.239	1.25	+0.9% 1.261	V
Reference Voltage (Accuracy) $V_{in} = 2.9$ V to $V_{out} + 4.0$ V, $I_{load} = 0.1$ mA to 500 mA, $T_A = 0^{\circ}\text{C}$ to $+85^{\circ}\text{C}$	V_{ref}	-1.4% 1.233	1.25	+1.4% 1.268	V
Reference Voltage (Accuracy) (Note 32) $V_{in} = 2.9$ V to $V_{out} + 4.0$ V, $I_{load} = 0.1$ mA to 500 mA, $T_A = -40^{\circ}\text{C}$ to $+125^{\circ}\text{C}$	V_{ref}	-1.5% 1.231	1.25	+1.5% 1.269	V
Line Regulation $V_{in} = 2.9$ V to 12 V, $I_{load} = 0.1$ mA	LineReg		0.04		mV/V
Load Regulation $V_{in} = 2.9$ V, $I_{load} = 0.1$ mA to 500 mA	LoadReg		0.04		mV/mA
Dropout Voltage (See App Note), $V_{out} = 2.5$ V to 10 V $I_{load} = 500$ mA (Note 33) $I_{load} = 300$ mA $I_{load} = 50$ mA $I_{load} = 0.1$ mA	V_{DO}			340 230 110 10	mV
Peak Output Current (Note 33) (See Figure 16)	I_{pk}	500	700	860	mA
Short Output Current (See Figure 16) $V_{out} \leq 3.3$ V $V_{out} > 3.3$ V	I_{sc}			900 990	mA
Thermal Shutdown	T_J		160		$^{\circ}\text{C}$
Ground Current In Regulation $I_{load} = 500$ mA (Note 33) $I_{load} = 300$ mA (Note 33) $I_{load} = 50$ mA $I_{load} = 0.1$ mA In Dropout $V_{in} = V_{out} - 0.1$ V or 2.2 V (whichever is higher), $I_{load} = 0.1$ mA In Shutdown $S_D = 0$ V	I_{GND} I_{GNDsh}		9.0 4.6 0.8 – – 0.07	14 7.5 2.5 190 500 1.0	mA μA
Output Noise $C_{nr} = 0$ nF, $I_{load} = 500$ mA, $f = 10$ Hz to 100 kHz, $C_{out} = 10$ μF $C_{nr} = 10$ nF, $I_{load} = 500$ mA, $f = 10$ Hz to 100 kHz, $C_{out} = 10$ μF	V_{noise}		38 26		μVrms μVrms
Shutdown Threshold Voltage ON Threshold Voltage OFF		2.0		0.4	V V
S_D Input Current, $V_{SD} = 0$ V to 0.4 V or $V_{SD} = 2.0$ V to V_{in} $V_{in} \leq 5.4$ V $V_{in} > 5.4$ V	I_{SD}		0.07	1.0 5.0	μA
Output Current In Shutdown Mode, $V_{out} = 0$ V	I_{OSD}		0.07	1.0	μA
Reverse Bias Protection, Current Flowing from the Output Pin to GND ($V_{in} = 0$ V, $V_{out_forced} = V_{out}(\text{nom}) \leq 7$ V) (Note 34)	I_{OUTR}		1.0		μA

31. Performance guaranteed over the operating temperature range by design and/or characterization, production tested at $T_J = T_A = 25^{\circ}\text{C}$. Low duty cycle pulse techniques are used during testing to maintain the junction temperature as close to ambient as possible.

32. For output current capability for $T_A < 0^{\circ}\text{C}$, please refer to Figures 18 to 22.

33. T_A must be greater than 0°C .

34. Reverse bias protection feature valid only if $V_{out} - V_{in} \leq 7$ V.

NCV8535

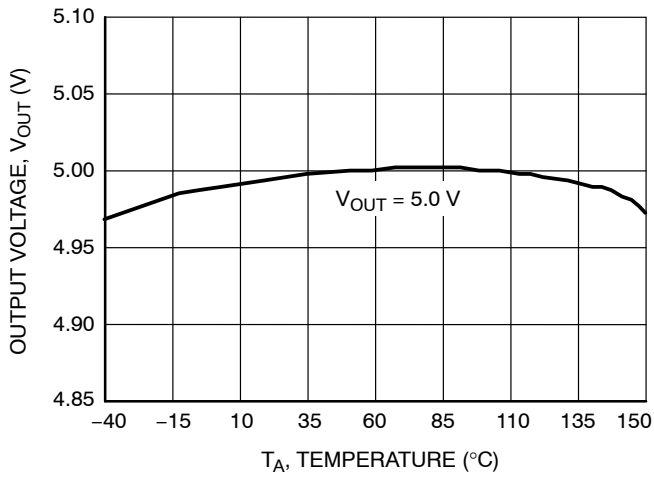

Figure 5. Output Voltage vs. Temperature
5.0 V Version

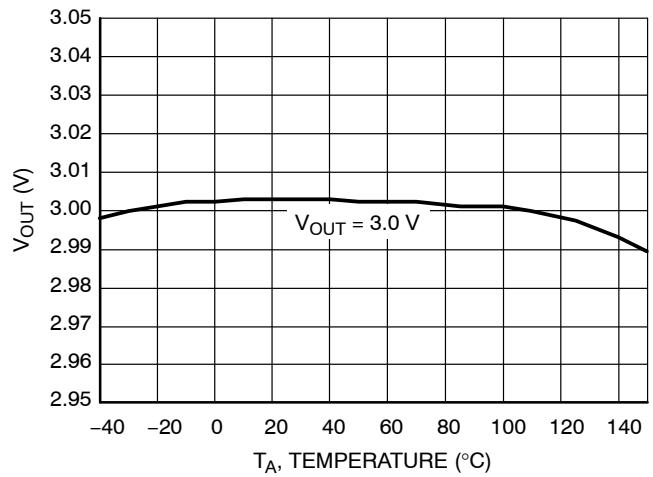

Figure 6. Output Voltage vs. Temperature
3.0 V Version

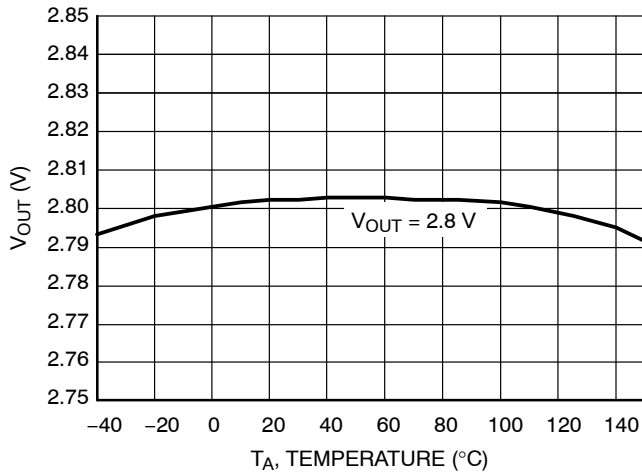

Figure 7. Output Voltage vs. Temperature
2.8 V Version

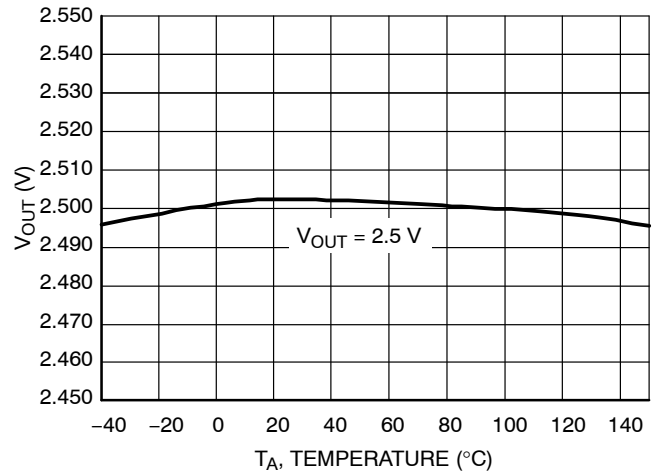

Figure 8. Output Voltage vs. Temperature
2.5 V Version

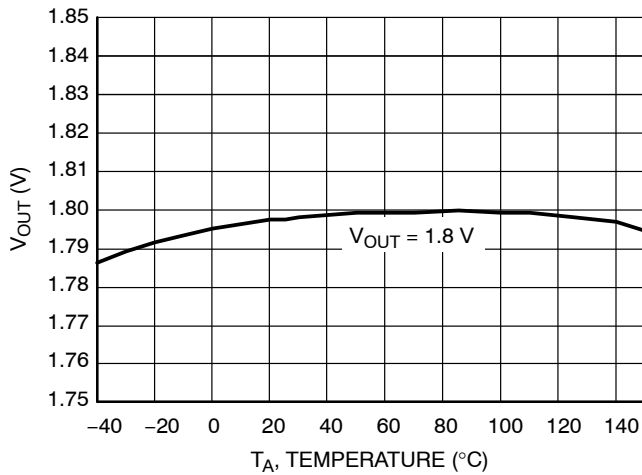

Figure 9. Output Voltage vs. Temperature
1.8 V Version

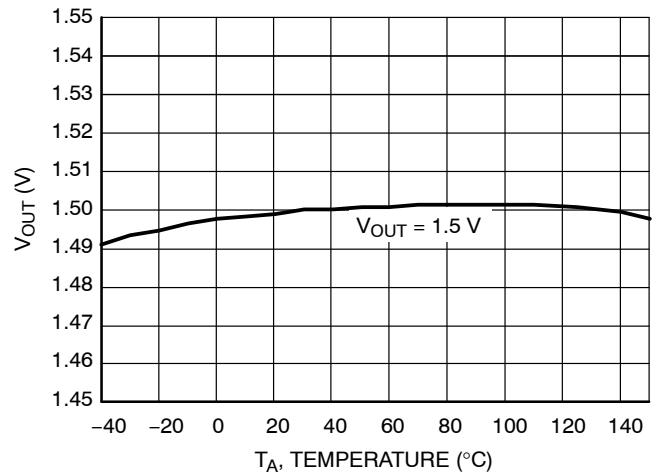
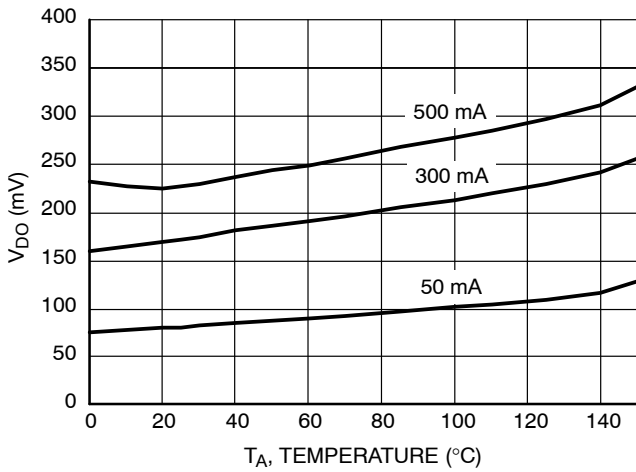
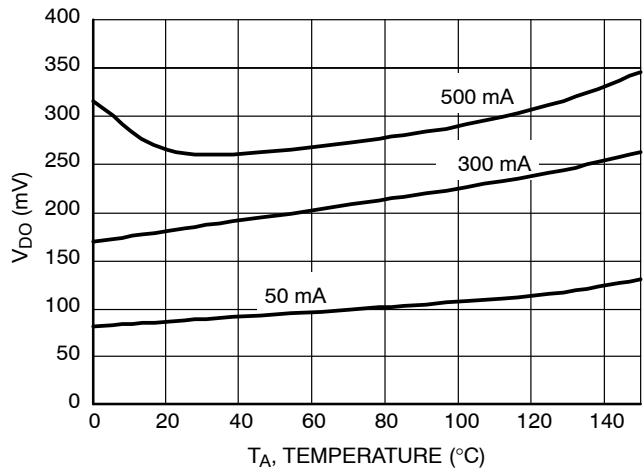

Figure 10. Output Voltage vs. Temperature
1.5 V Version

NCV8535



**Figure 11. Dropout Voltage vs. Temperature
2.8 V Version**



**Figure 12. Dropout Voltage vs. Temperature
2.5 V Version**

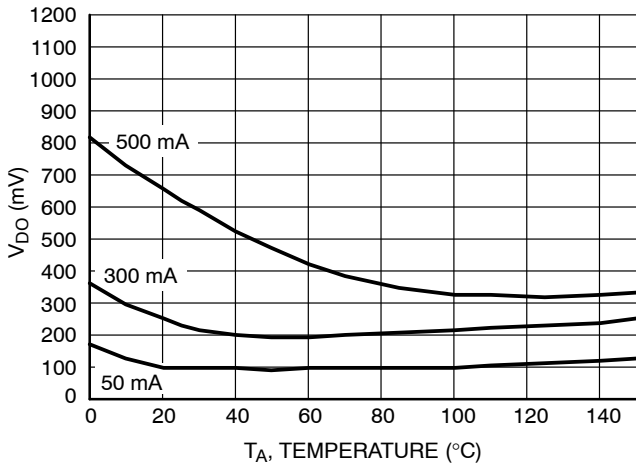

**Figure 13. Dropout Voltage vs. Temperature
1.8 V Version**

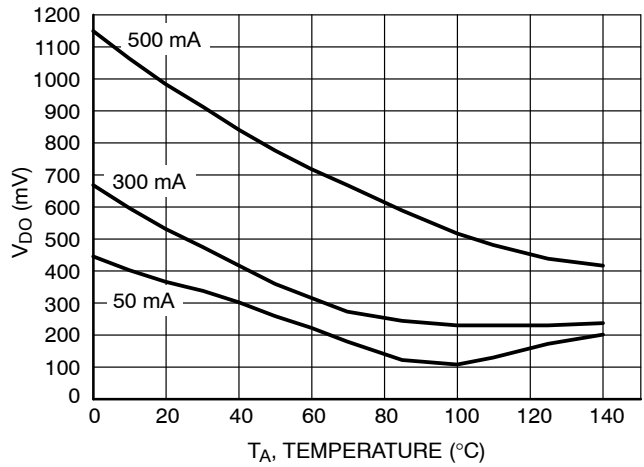

**Figure 14. Dropout Voltage vs. Temperature
1.5 V Version**

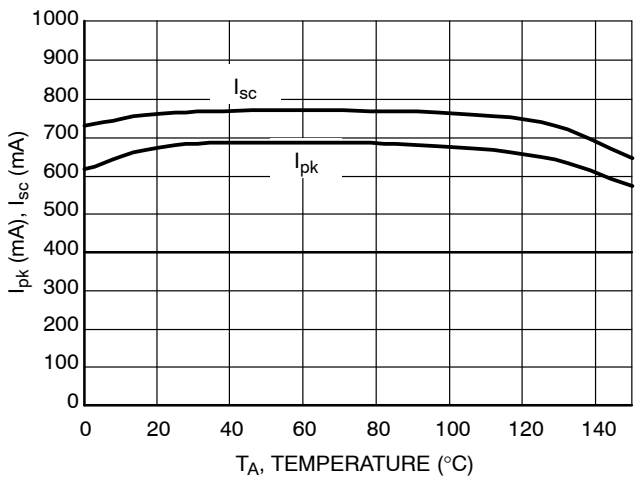

**Figure 15. Peak and Short Current
vs. Temperature**

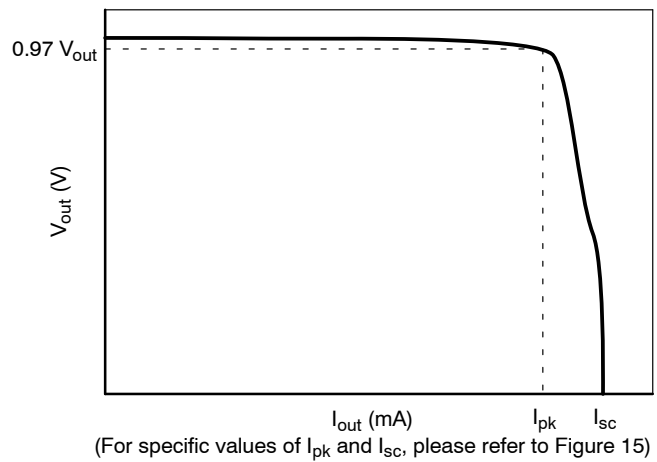

Figure 16. Output Voltage vs. Output Current
(For specific values of I_{pk} and I_{sc} , please refer to Figure 15)

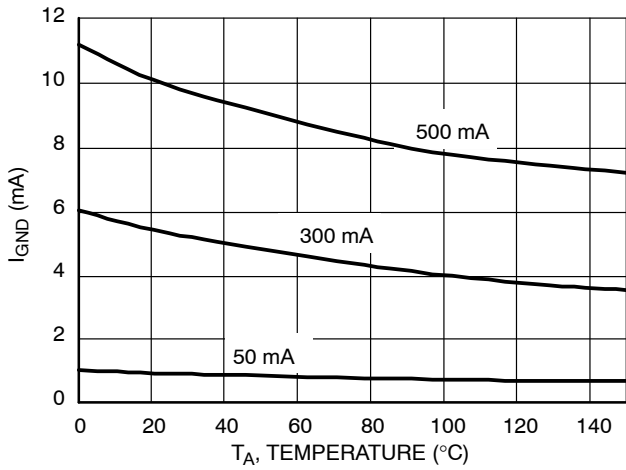

Figure 17. Ground Current vs. Temperature

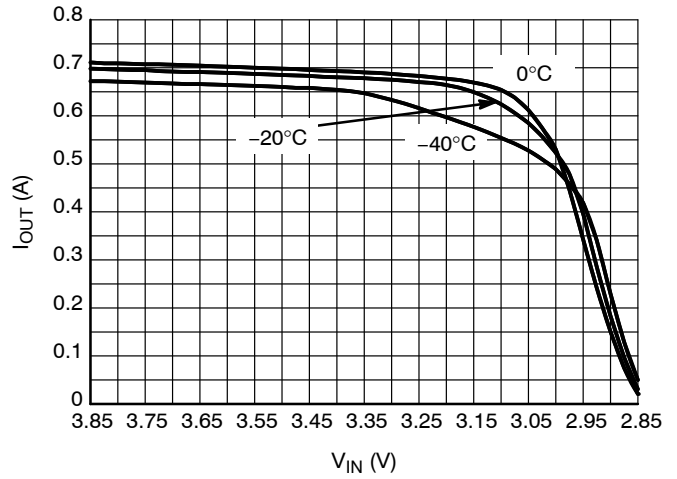

Figure 18. Output Current Capability for the 2.85 V Version

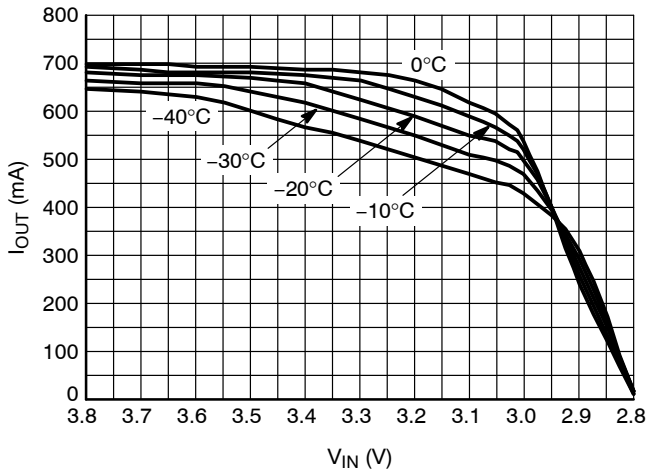

Figure 19. Output Current Capability for the 2.8 V Version

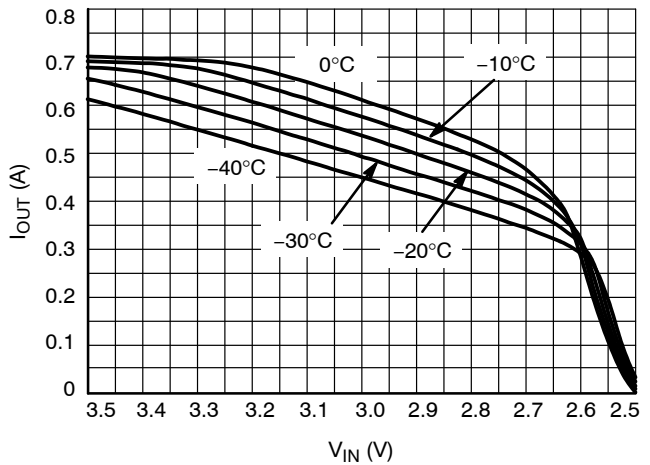

Figure 20. Output Current Capability for the 2.5 V Version

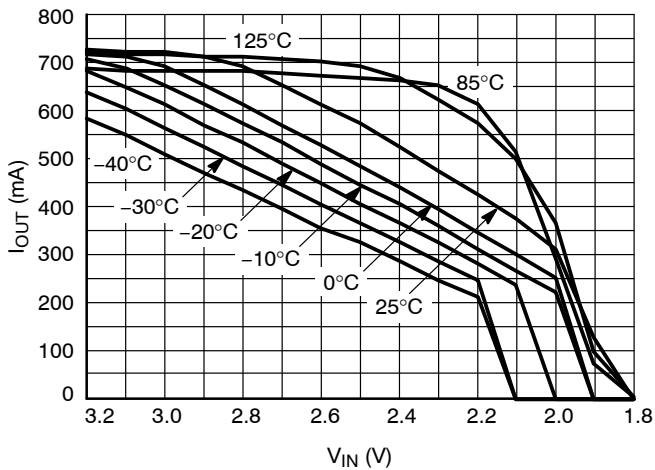

Figure 21. Output Current Capability for the 1.8 V Version

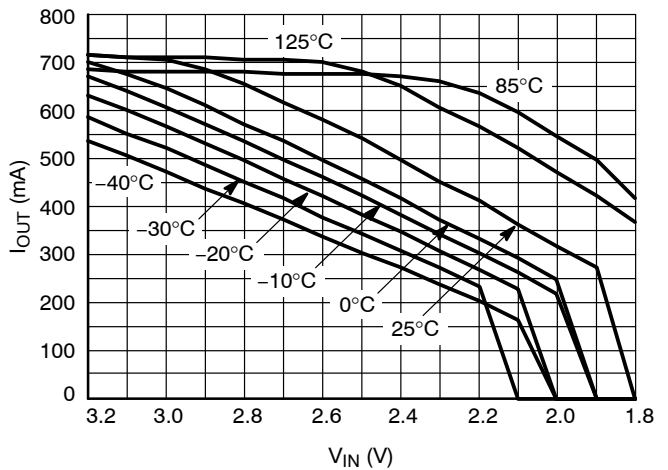

Figure 22. Output Current Capability for the 1.5 V Version

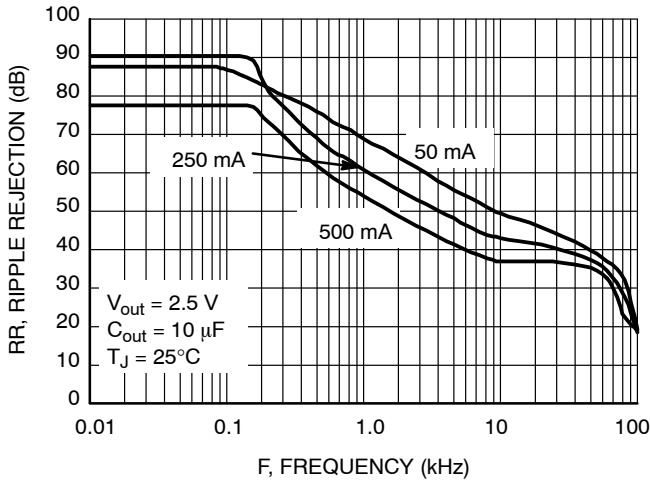

Figure 23. Ripple Rejection vs. Frequency

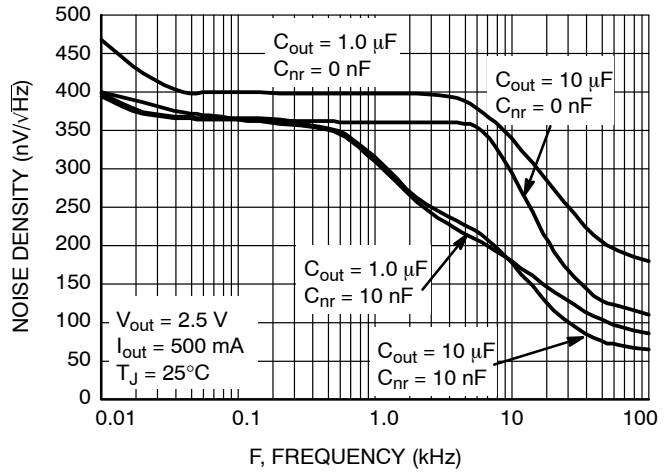

Figure 24. Output Noise Density

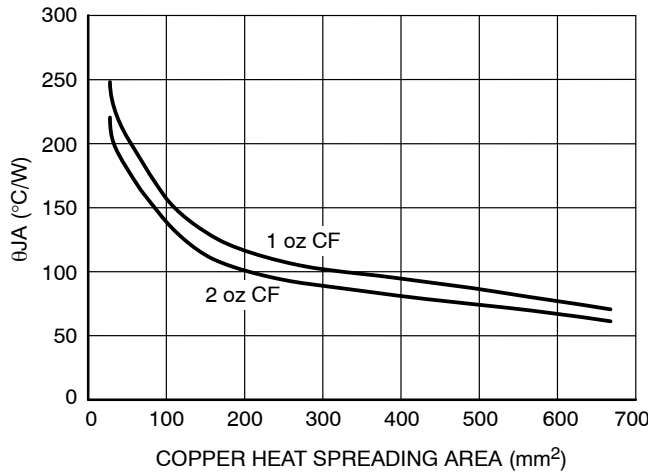

Figure 25. DFN 10 Self Heating Thermal Characteristic as a Function of Copper Area on the PCB

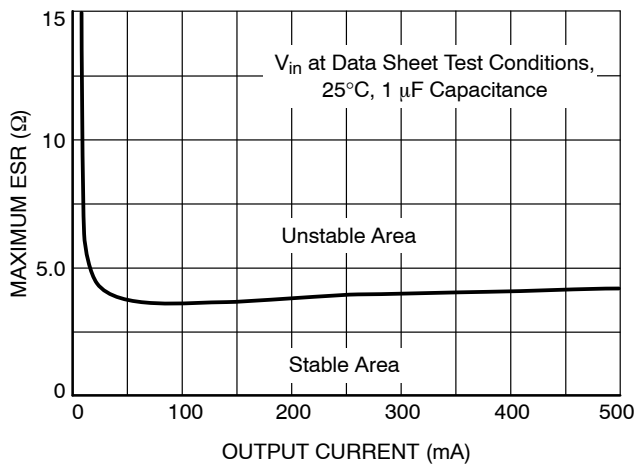

Figure 26. Stability with ESR vs. I_{out}

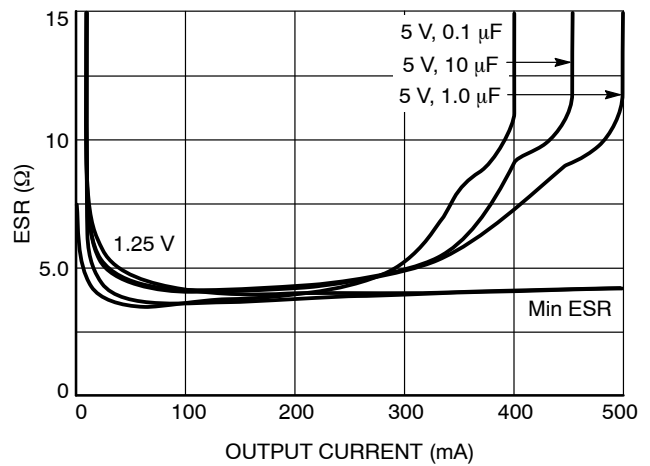

Figure 27. Output Current vs. ESR

NOTE: Typical characteristics were measured with the same conditions as electrical characteristics.

APPLICATIONS INFORMATION

Reverse Bias Protection

Reverse bias is a condition caused when the input voltage goes to zero, but the output voltage is kept high either by a large output capacitor or another source in the application which feeds the output pin.

Normally in a bipolar LDO all the current will flow from the output pin to input pin through the PN junction with limited current capability and with the potential to destroy the IC.

Due to an improved architecture, the NCV8535 can withstand up to 7.0 V on the output pin with virtually no current flowing from output pin to input pin, and only negligible amount of current (tens of μA) flowing from the output pin to ground for infinite duration.

Input Capacitor

An input capacitor of at least 1.0 μF , any type, is recommended to improve the transient response of the regulator and/or if the regulator is located more than a few inches from the power source. It will also reduce the circuit's sensitivity to the input line impedance at high frequencies. The capacitor should be mounted with the shortest possible track length directly across the regular's input terminals.

Output Capacitor

The NCV8535 remains stable with any type of capacitor as long as it fulfills its 1.0 μF requirement. There are no constraints on the minimum ESR and it will remain stable up to an ESR of 5.0 Ω . Larger capacitor values will improve the noise rejection and load transient response.

Noise Reduction Pin

Output noise can be greatly reduced by connecting a 10 nF capacitor (C_{nr}) between the noise reduction pin and ground (see Figure 1). In applications where very low noise is not required, the noise reduction pin can be left unconnected.

For the adjustable version, in addition to the 10 nF C_{nr} , a 68 pF capacitor connected in parallel with R1 (see Figure 2) is recommended to further reduce output noise and improve stability.

Adjustable Operation

The output voltage can be set by using a resistor divider as shown in Figure 2 with a range of 1.25 to 10 V. The appropriate resistor divider can be found by solving the equation below. The recommended current through the resistor divider is from 10 μA to 100 μA . This can be accomplished by selecting resistors in the $\text{k}\Omega$ range. As result, the $I_{adj} * R2$ becomes negligible in the equation and can be ignored.

$$V_{out} = 1.25 * \left(1 + \frac{R1}{R2}\right) + I_{adj} * R2 \quad (\text{eq. 1})$$

Example:

For $V_{out} = 2.9 \text{ V}$, can use $R1 = 36 \text{ k}\Omega$ and $R2 = 27 \text{ k}\Omega$.

$$1.25 * \left(1 + \frac{36 \text{ k}\Omega}{27 \text{ k}\Omega}\right) = 2.91 \text{ V} \quad (\text{eq. 2})$$

Dropout Voltage

The voltage dropout is measured at 97% of the nominal output voltage.

No-Load Regulation Considerations

If there is no load at output of the regulator and ambient temperature is higher than 85°C leakage current flowing from input to output through pass transistor may cause increase of output voltage out of specification range up to input voltage level. To avoid this situation minimum load current of 100 μA or higher is recommended if ambient temperature exceeds 85°C.

Thermal Considerations

Internal thermal limiting circuitry is provided to protect the integrated circuit in the event that the maximum junction temperature is exceeded. This feature provides protection from a catastrophic device failure due to accidental overheating. This protection feature is not intended to be used as a substitute to heat sinking. The maximum power that can be dissipated, can be calculated with the equation below:

$$P_D = \frac{T_{J(max)} - T_A}{R_{\theta JA}} \quad (\text{eq. 3})$$

NCV8535

DEVICE ORDERING INFORMATION

Device*	Voltage Option	Marking Code	Package	Feature	Shipping†
NCV8535MNADJR2G	Adj.	V8535 ADJ	DFN10 (Pb-Free)	Non-Wettable Flank	3000 / Tape & Reel
NCV8535MN150R2G	1.5 V	V8535 150			
NCV8535MN180R2G	1.8 V	V8535 180			
NCV8535MN190R2G	1.9 V	V8535 190			
NCV8535MN250R2G	2.5 V	V8535 250			
NCV8535MN280R2G	2.8 V	V8535 280			
NCV8535MN285R2G	2.85 V	V8535 285			
NCV8535MN300R2G	3.0 V	V8535 300			
NCV8535MN330R2G	3.3 V	V8535 330			
NCV8535MN350R2G	3.5 V	V8535 350			
NCV8535MN500R2G	5.0 V	V8535 500			
NCV8535MLADJR2G	Adj.	L8535 ADJ	DFN10 (Pb-Free)	Wettable Flank SLP Process	3000 / Tape & Reel
NCV8535ML180R2G	1.8 V	L8535 180			
NCV8535ML250R2G	2.5 V	L8535 250			
NCV8535ML330R2G	3.3 V	L8535 330			

†For information on tape and reel specifications, including part orientation and tape sizes, please refer to our Tape and Reel Packaging Specifications Brochure, BRD8011/D.

*NCV Prefix for Automotive and Other Applications Requiring Unique Site and Control Change Requirements; AEC-Q100 Qualified and PPAP Capable.

MECHANICAL CASE OUTLINE PACKAGE DIMENSIONS



SCALE 2:1

DFN10, 3x3, 0.5P CASE 485C ISSUE F

DATE 16 DEC 2021

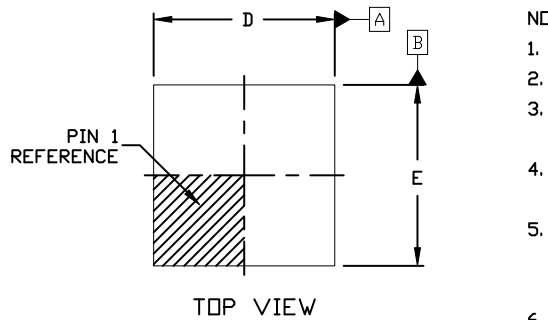

NOTES:

1. DIMENSION AND TOLERANCING PER ASME Y14.5, 2009.
2. CONTROLLING DIMENSION: MILLIMETERS
3. DIMENSION *b* APPLIES TO PLATED TERMINAL AND IS MEASURED BETWEEN 0.15 AND 0.30 MM FROM THE TERMINAL TIP.
4. COPLANARITY APPLIES TO THE EXPOSED PAD AS WELL AS THE TERMINALS.
5. TERMINAL *b* MAY HAVE MOLD COMPOUND MATERIAL ALONG SIDE EDGE. MOLD FLASH MAY NOT EXCEED 30 MICRONS ONTO BOTTOM SURFACE OF TERMINAL.
6. FOR DEVICE OPN CONTAINING W OPTION, DETAIL A AND DETAIL B ALTERNATE CONSTRUCTIONS ARE NOT APPLICABLE. WETTABLE FLANK CONSTRUCTION IS DETAIL B AS SHOWN ON SIDE VIEW OF PACKAGE.

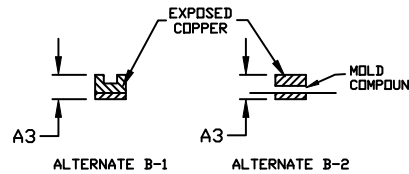
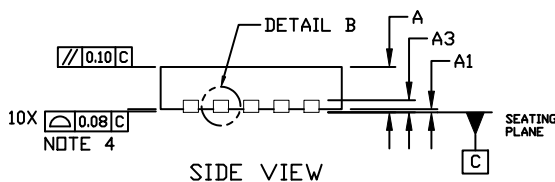

DIM	MILLIMETERS		
	MIN.	NOM.	MAX.
A	0.80	0.90	1.00
A1	0.00	---	0.05
A3	0.20 REF		
<i>b</i>	0.18	0.23	0.30
D	2.90	3.00	3.10
D2	2.40	2.50	2.60
E	2.90	3.00	3.10
E2	1.70	1.80	1.90
<i>e</i>	0.50 BSC		
K	0.20 REF		
L	0.30	0.40	0.50
L1	---	---	0.03

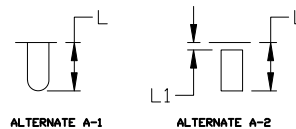
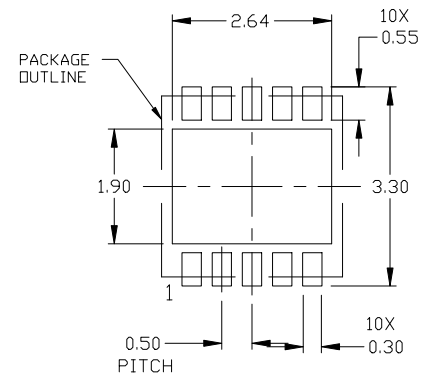
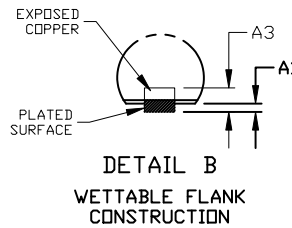
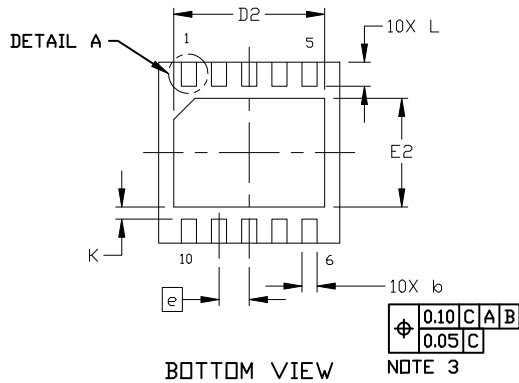

GENERIC MARKING DIAGRAM*

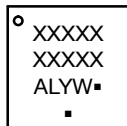

- XXXXX = Specific Device Code
- A = Assembly Location
- L = Wafer Lot
- Y = Year
- W = Work Week
- = Pb-Free Package

(Note: Microdot may be in either location)

*This information is generic. Please refer to device data sheet for actual part marking. Pb-Free indicator, "G" or microdot "▪", may or may not be present. Some products may not follow the Generic Marking.

RECOMMENDED MOUNTING FOOTPRINT

For additional information on our Pb-Free strategy and soldering details, please download the ON Semiconductor Soldering and Mounting Techniques Reference Manual, SOLDERRM/D.

DOCUMENT NUMBER:	98AON03161D	Electronic versions are uncontrolled except when accessed directly from the Document Repository. Printed versions are uncontrolled except when stamped "CONTROLLED COPY" in red.
DESCRIPTION:	DFN10, 3X3 MM, 0.5 MM PITCH	PAGE 1 OF 1

onsemi and ONSEMI are trademarks of Semiconductor Components Industries, LLC dba onsemi or its subsidiaries in the United States and/or other countries. onsemi reserves the right to make changes without further notice to any products herein. onsemi makes no warranty, representation or guarantee regarding the suitability of its products for any particular purpose, nor does onsemi assume any liability arising out of the application or use of any product or circuit, and specifically disclaims any and all liability, including without limitation special, consequential or incidental damages. onsemi does not convey any license under its patent rights nor the rights of others.



DFNW10 3x3, 0.5P
CASE 507AM
ISSUE A

DATE 12 JUN 2018

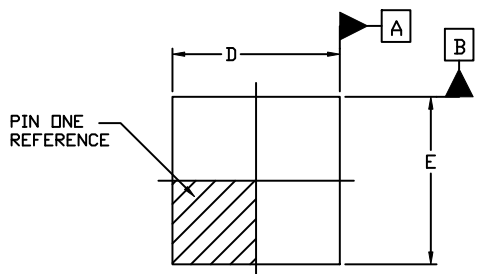

TOP VIEW

NOTES:

1. DIMENSIONING AND TOLERANCING PER ASME Y14.5M, 1994.
2. CONTROLLING DIMENSION: MILLIMETERS
3. DIMENSION *b* APPLIES TO PLATED TERMINAL AND IS MEASURED BETWEEN 0.25 AND 0.30 MM FROM THE TERMINAL TIP.
4. COPLANARITY APPLIES TO THE EXPOSED PAD AS WELL AS THE TERMINALS.

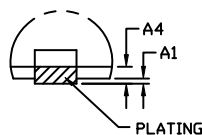

DETAIL B

DIM	MILLIMETERS		
	MIN.	NOM.	MAX.
A	0.80	0.90	1.00
A1	0.00	---	0.05
A3	0.20 REF		
A4	0.10	---	---
<i>b</i>	0.20	0.25	0.30
D	2.85	3.00	3.15
D2	2.40	2.50	2.60
E	2.85	3.00	3.15
E2	1.70	1.80	1.90
<i>e</i>	0.50 BSC		
<i>k</i>	0.19 REF		
L	0.35	0.40	0.45
L3	---	0.05	0.10

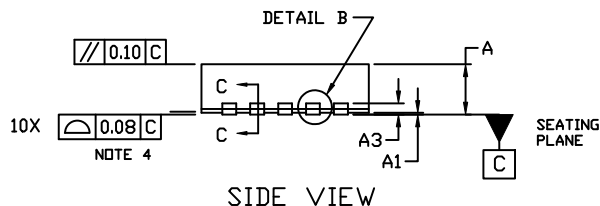

SIDE VIEW

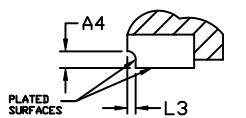

SECTION C-C

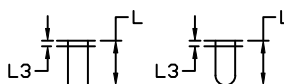

ALTERNATE CONSTRUCTION
 DETAIL A

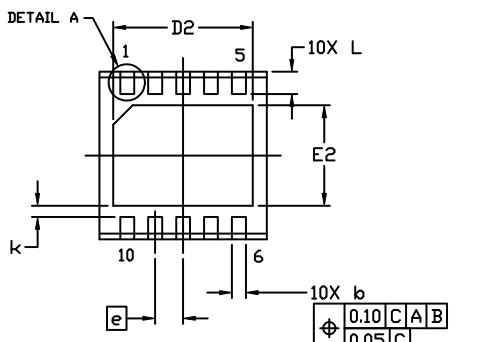

BOTTOM VIEW

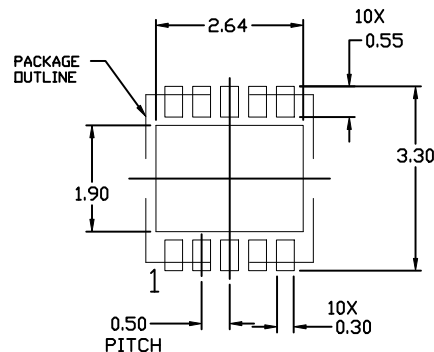

RECOMMENDED MOUNTING FOOTPRINT

GENERIC MARKING DIAGRAM*

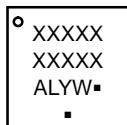

- XXXXX = Specific Device Code
 - A = Assembly Location
 - L = Wafer Lot
 - Y = Year
 - W = Work Week
 - = Pb-Free Package
- (Note: Microdot may be in either location)

*This information is generic. Please refer to device data sheet for actual part marking. Pb-Free indicator, "G" or microdot "▪", may or may not be present. Some products may not follow the Generic Marking.

DOCUMENT NUMBER:	98AON85414G	Electronic versions are uncontrolled except when accessed directly from the Document Repository. Printed versions are uncontrolled except when stamped "CONTROLLED COPY" in red.
DESCRIPTION:	DFNW10 3x3, 0.5P	PAGE 1 OF 1

ON Semiconductor and are trademarks of Semiconductor Components Industries, LLC dba ON Semiconductor or its subsidiaries in the United States and/or other countries. ON Semiconductor reserves the right to make changes without further notice to any products herein. ON Semiconductor makes no warranty, representation or guarantee regarding the suitability of its products for any particular purpose, nor does ON Semiconductor assume any liability arising out of the application or use of any product or circuit, and specifically disclaims any and all liability, including without limitation special, consequential or incidental damages. ON Semiconductor does not convey any license under its patent rights nor the rights of others.

onsemi, **Onsemi**, and other names, marks, and brands are registered and/or common law trademarks of Semiconductor Components Industries, LLC dba "**onsemi**" or its affiliates and/or subsidiaries in the United States and/or other countries. **onsemi** owns the rights to a number of patents, trademarks, copyrights, trade secrets, and other intellectual property. A listing of **onsemi**'s product/patent coverage may be accessed at www.onsemi.com/site/pdf/Patent-Marking.pdf. **onsemi** reserves the right to make changes at any time to any products or information herein, without notice. The information herein is provided "as-is" and **onsemi** makes no warranty, representation or guarantee regarding the accuracy of the information, product features, availability, functionality, or suitability of its products for any particular purpose, nor does **onsemi** assume any liability arising out of the application or use of any product or circuit, and specifically disclaims any and all liability, including without limitation special, consequential or incidental damages. Buyer is responsible for its products and applications using **onsemi** products, including compliance with all laws, regulations and safety requirements or standards, regardless of any support or applications information provided by **onsemi**. "Typical" parameters which may be provided in **onsemi** data sheets and/or specifications can and do vary in different applications and actual performance may vary over time. All operating parameters, including "Typicals" must be validated for each customer application by customer's technical experts. **onsemi** does not convey any license under any of its intellectual property rights nor the rights of others. **onsemi** products are not designed, intended, or authorized for use as a critical component in life support systems or any FDA Class 3 medical devices or medical devices with a same or similar classification in a foreign jurisdiction or any devices intended for implantation in the human body. Should Buyer purchase or use **onsemi** products for any such unintended or unauthorized application, Buyer shall indemnify and hold **onsemi** and its officers, employees, subsidiaries, affiliates, and distributors harmless against all claims, costs, damages, and expenses, and reasonable attorney fees arising out of, directly or indirectly, any claim of personal injury or death associated with such unintended or unauthorized use, even if such claim alleges that **onsemi** was negligent regarding the design or manufacture of the part. **onsemi** is an Equal Opportunity/Affirmative Action Employer. This literature is subject to all applicable copyright laws and is not for resale in any manner.

PUBLICATION ORDERING INFORMATION

LITERATURE FULFILLMENT:

Email Requests to: orderlit@onsemi.com

onsemi Website: www.onsemi.com

TECHNICAL SUPPORT

North American Technical Support:
Voice Mail: 1 800-282-9855 Toll Free USA/Canada
Phone: 011 421 33 790 2910

Europe, Middle East and Africa Technical Support:

Phone: 00421 33 790 2910

For additional information, please contact your local Sales Representative