

NCV7429

System Basis Chip with LIN, LS and HS Switches

Description

The NCV7429 is a monolithic LIN System-Basis-Chip with enhanced feature set useful in Automotive Body Control systems. Besides the LIN bus interface the IC features a 5 V voltage regulator, high-side and low-side switches to control LEDs and relays, and supervision functionality like a window watchdog. This allows a highly integrated solution by replacing external discrete components while maintaining the system flexibility. As a consequence, the board space and ECU weight can be minimized.

Features

- Main Supply Functional Operating Range from 5 V to 28 V
- Main Supply Parametrical Operating Range 6 V to 18 V
- LIN Physical Layer According to ISO 17987-4 (backwards compatible to LIN 1.3, LIN 2.x) and SAE J2602
- Power Management Through Operating Modes: Normal, Standby, Sleep and Flash
- Software Development Mode for Software Debugging
- Low Drop Voltage Regulator VR1: 5 V/150 mA, 2%
- One Wake-up Input, e.g. for Contact Monitoring
- Wake-up Logic with Cyclic Contact Monitoring
- Wake-up Source Recognition
- Independent PWM Functionality for All Outputs (Integrated PWM Registers)
- Window Watchdog with Programmable Times
- 2x Low-side Driver (typ. 1.5 Ω) with Over-load Protection and Active Clamp; e.g. for Relays
- 3x High-side Driver (typ. 5 Ω) with Over- and Under-load Detection; e.g. for LED's and Switches
- 24-bit SPI Interface
- Protection against Short Circuit, Over-voltage and Over-temperature
- TSSOP-20 EP Package
- NCV Prefix for Automotive and Other Applications Requiring Unique Site and Control Change Requirements; AEC-Q100 Qualified and PPAP Capable
- These Devices are Pb-Free, Halogen Free/BFR Free and are RoHS Compliant

Typical Applications

- De-centralized Door Electronic Systems



ON Semiconductor®

www.onsemi.com



TSSOP-20 EP
CASE 948AB

MARKING DIAGRAM

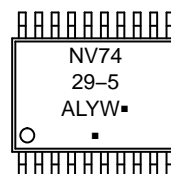

- A = Assembly Location
- L = Wafer Lot
- Y = Year
- W = Work Week
- = Pb-Free Package

(Note: Microdot may be in either location)

PIN ASSIGNMENT

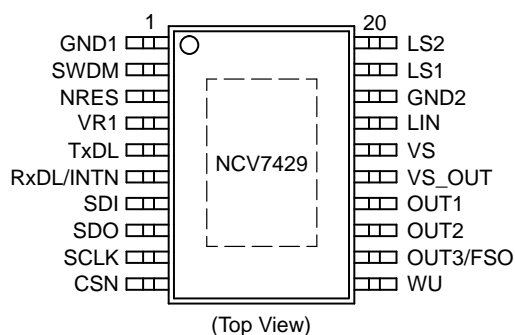

ORDERING INFORMATION

Device	Package	Shipping†
NCV7429DE5R2G	TSSOP-20 (Pb-Free)	2500 / Tape & Reel

†For information on tape and reel specifications, including part orientation and tape sizes, please refer to our Tape and Reel Packaging Specification Brochure, BRD8011/D.

NCV7429

BLOCK DIAGRAM

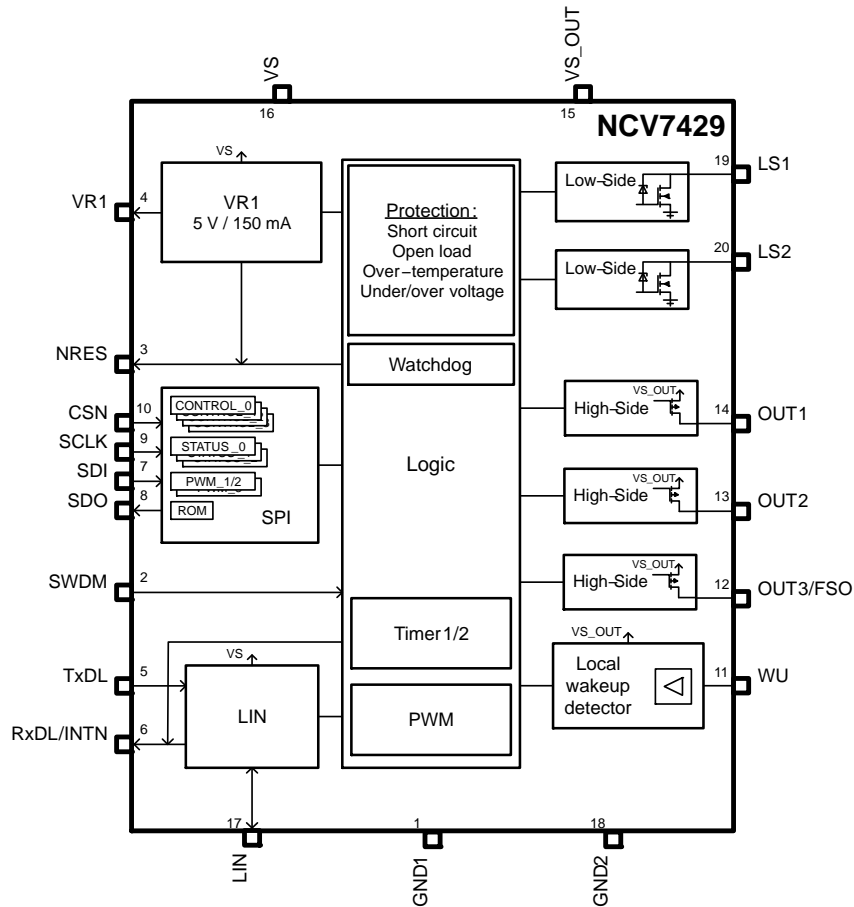

Figure 1. Block Diagram

Table 1. PIN DESCRIPTION

Pin No.	Pin Name	Pin Type	Description
1	GND1	Ground	Ground connection
2	SWDM	HV Digital Input with Pull-down	Software development mode entry input
3	NRES	Digital Open-drain Output with Internal Pull-up	Reset signal to the MCU
4	VR1	5 V Regulator Output	2%, 150 mA
5	TxDL	Digital Input with Pull-up	Transmitter data input of the LIN transceiver
6	RxDL/INTN	Digital Push-pull Output	Receiver output of the LIN transceiver/Interrupt output
7	SDI	Digital Input with Pull-down	SPI data input
8	SDO	Digital Push-pull Output, Tristate	SPI data output
9	SCLK	Digital Input with Pull-down	SPI clock input
10	CSN	Digital Input with Pull-up	SPI chip select input
11	WU	HV Input	Voltage-sense input (threshold typ. VS_OUT/2), switched pull-up/down
12	OUT3/FSO	HS Driver	Resistive loads, Ron 5 Ω typ, Ilim > 140 mA / FSO output
13	OUT2	HS Driver	Resistive loads, Ron 5 Ω typ, Ilim > 140 mA

NCV7429

Table 1. PIN DESCRIPTION (continued)

Pin No.	Pin Name	Pin Type	Description
14	OUT1	HS Driver	Resistive loads, Ron 5/20 Ω typ, Ilim > 140/35 mA, two configurations
15	VS_OUT	Battery Supply Input	Power-supply of the high-side drivers OUT1–3 and WU input
16	VS	Battery Supply Input	Principle power-supply of the device
17	LIN	LIN Bus Interface	LIN bus pin, low in dominant state
18	GND2	Ground	Ground connection
19	LS1	LS Driver	Low-side Driver, Ron 1.5 Ω typ, Ilim > 250 mA, active clamp to ground
20	LS2	LS Driver	Low-side Driver, Ron 1.5 Ω typ, Ilim > 250 mA, active clamp to ground
	Exposed Pad	Ground	Substrate; Exposed pad has to be connected to both GND pins

APPLICATION INFORMATION

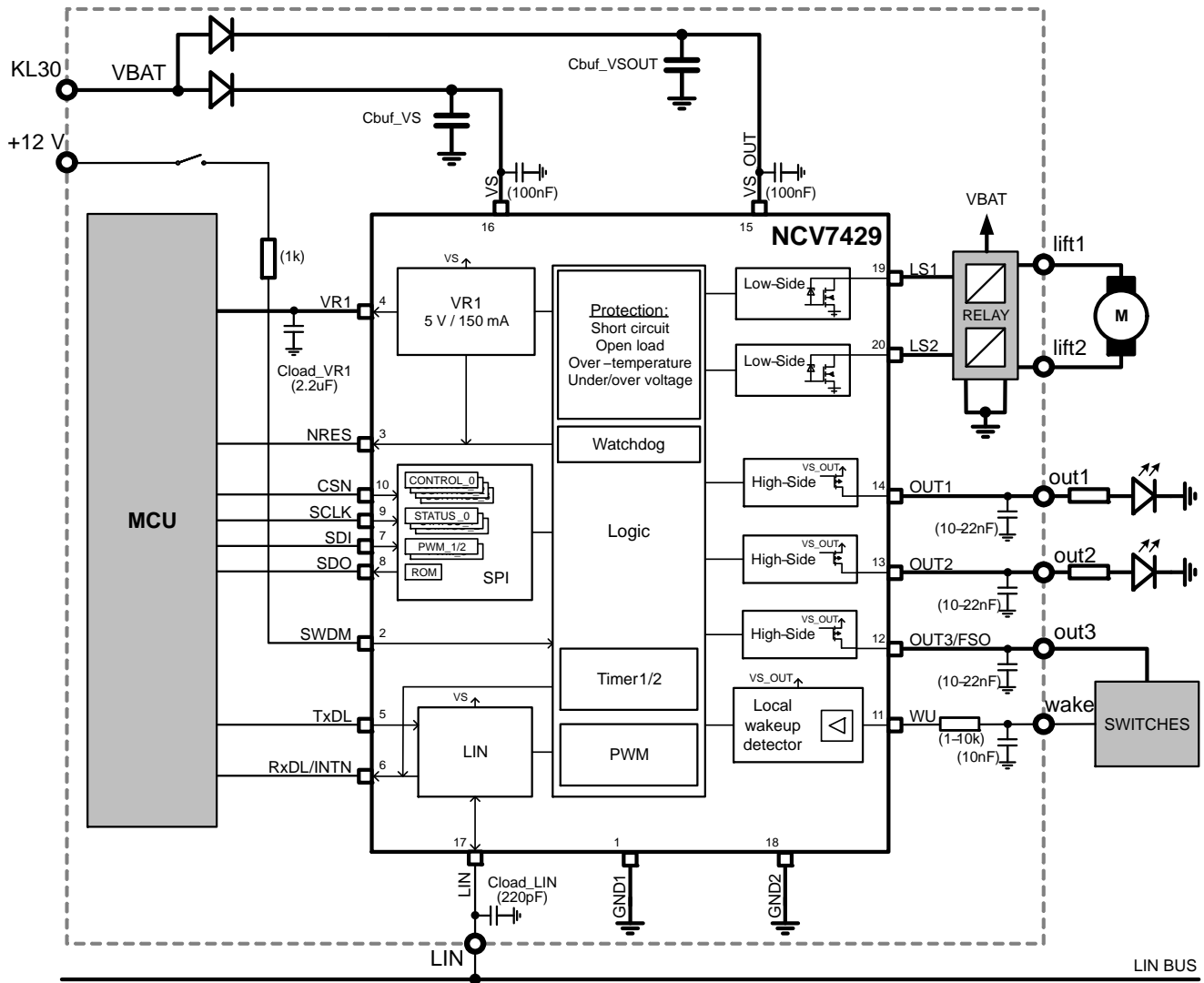

Figure 2. Example Application Diagram

Table 2. ABSOLUTE MAXIMUM RATINGS

Symbol	Parameter	Min	Max	Unit
V _{max_VS} , V _{max_VS_OUT}	Power Supply Voltage	-0.3	40	V
V _{max_WU}	Wake Pin Voltage Range	-0.3	VS_OUT + 0.3	V
V _{max_OUT1-3}	High-side Output OUT1-3 Voltage Range	-0.3	VS_OUT + 0.3	V
V _{max_LS1/2}	LS1/2 Pin Voltage Range DC (Voltage Internally Limited during Flyback)	-0.3	40	V
W _{max_LS1/2}	Maximum LS1/2 Clamping Energy		36	mJ
I _{max_LS1/2}	Maximum LS1/2 Pin Current		500	mA
	Maximum LS1/2 Pin Current, Transient or without VS and VS_OUT Supply	-120		mA
V _{max_LIN}	DC Voltage on LIN Pin	-40	40	V
V _{max_VR1}	Stabilized Supply Voltage, Logic Supply	-0.3	min(5.5, VS + 0.3)	V
V _{max_digiO}	DC Voltage at Digital Pins (NRES, TxDL, RxDL/INTN, SDI, SDO, SCLK, CSN)	-0.3	VR1 + 0.3	V
V _{max_SWDM}	DC Voltage at SWDM Input	-0.3	40	V
ESD Human Body Model Following EIA-JESD22 (100 pF, 1500 Ω)	All Pins	-2	+2	kV
	Pin LIN to GND	-4	+4	
	Pins OUT1-3, LS1/2 to GND	-4	+4	
ESD Following IEC 61000-4-2 (150pF, 330Ω)	Valid for Pins VS, VS_OUT, LIN, OUT1-3, WU - VS, VS_OUT pins with reverse-protection and filtering capacitor - OUT1-3 pins with parallel capacitor 10 nF - WU pin stressed through a serial resistor > 10 kΩ	-6	+6	kV
ESD Charged Device Model Following JESD22-C101/AE C-Q100-011	All Pins	-500	+500	V
	Corner Pins	-750	+750	V
T _{j_mr}	Junction Temperature	-40	+170	°C
T _{stg}	Storage Temperature Range	-55	+150	°C
MSL	Moisture Sensitivity Level (max. 260°C Processing)		2	

Stresses exceeding those listed in the Maximum Ratings table may damage the device. If any of these limits are exceeded, device functionality should not be assumed, damage may occur and reliability may be affected.

Table 3. THERMAL CHARACTERISTICS

Symbol	Parameter	Value	Unit
R _{θJC}	Thermal Characteristics		
R _{θJA}	Thermal Resistance, Junction-to-Case	8.3	°C/W
R _{θJA}	Thermal Resistance, Junction-to-Ambient, 1S0P PCB (Note 1)	70	
R _{θJA}	Thermal Resistance, Junction-to-Ambient, 2S2P PCB (Note 2)	40	

1. Value based on test board according to JESD51-3 standard, signal layer with 10% trace coverage.
2. Value based on test board according to JESD51-7 standard, signal layers with 20% trace coverage, inner planes with 90% coverage.

Table 4. RECOMMENDED OPERATING RANGES

Symbol	Parameter	Min	Max	Unit
Vop_VS_par, Vop_VS_OUT_par	Power Supply Voltage for Valid Parameter Specifications	6	18	V
Vop_VS_func, Vop_VS_OUT_func	Power Supply for Correct Functional Behavior	5	28	V
Vop_WU	Wake Pin Voltage Range	0	VS_OUT	V
Vop_OUT1-3	High-side Output OUT1-3 Voltage Range	0	VS_OUT	V
Vop_LS1/2	LS1/2 Pin Voltage Range DC (voltage internally limited during flyback)	0	VS_OUT	V
Vop_LIN	LIN Pin Voltage Range	0	VS	V
Vop_VR1	Stabilized Supply Voltage, Logic Supply	4.9	5.1	V
Vop_digIO	DC Voltage at Digital Pins (NRES, TxDL, RxDL/INTN, SDI, SDO, SCLK, CSN)	0	VR1	V
Vop_SWDM	DC Voltage at SWDM Input	0	VS	V
Tj_op	Junction Temperature	-40	+150	°C

Functional operation above the stresses listed in the Recommended Operating Ranges is not implied. Extended exposure to stresses beyond the Recommended Operating Ranges limits may affect device reliability.

Table 5. ELECTRICAL CHARACTERISTICS

(6 V ≤ VS ≤ 18 V, 6 V ≤ VS_out ≤ 18 V, -40°C ≤ Tj ≤ 150°C; unless otherwise specified)

Symbol	Parameter	Conditions	Min	Typ	Max	Unit
VS SUPPLY						
VS, VS_OUT	Supply Voltage	Functional, Voltage Regulators with Deteriorated Performance	5		28	V
		Parameter Specification	6		18	
VS_PORH	VS POR Threshold	VS Rising	3.4		4.1	V
VS_PORL	VS POR Threshold	VS Falling	2.1		3.0	V
VS_OUT_UV	VS_OUT UV-threshold Voltage	VS Falling	5.1		5.8	V
VS_OUT_UV_hyst	Undervoltage Hysteresis		0.1		0.5	V
VS_OUT_OV	VS_OUT OV-threshold Voltage	VS Rising	20		22	V
VS_OUT_OV_hyst	Overvoltage Hysteresis		0.3	0.5	0.8	V
I_VS_norm	VS Consumption in Normal Mode	Normal mode, VR1 on (not loaded), bus communication off, TxDL not active		0.6	1.1	mA
I_VS_stby	VS Consumption in Standby Mode (Static Sense)	Standby mode, VS = 12 V, VR1 on (not loaded), no LIM bus communication, no wake-up request pending, WU wakeup disabled, Tj = 85°C (Note 3)		28	60	µA
I_VS_sleep	VS Consumption in Sleep Mode (Static Sense)	Sleep mode, VS = 12 V, VR1 off, no LIM bus communication, no wake-up request pending, WU wakeup disabled, Tj = 85°C (Note 3)		15	30	µA
I_VS_add_VR1	VR1 Current Consumption from VS	Normal/Standby mode, VR1 loaded		0.005 · I_VR1		mA
I_VS_add_LS	Added LSx Drivers Current Consumption from VS	N = 1 – 2 ... number of LSx drivers active		15 + 20·N	110	µA

Table 5. ELECTRICAL CHARACTERISTICS (continued)

(6 V ≤ V_S ≤ 18 V, 6 V ≤ V_{S_OUT} ≤ 18 V, -40°C ≤ T_j ≤ 150°C; unless otherwise specified)

Symbol	Parameter	Conditions	Min	Typ	Max	Unit
--------	-----------	------------	-----	-----	-----	------

VS SUPPLY

I_VS_add_WU	Added WU Comparator Current Consumption from VS			0.6	2	μA
-------------	---	--	--	-----	---	----

VS_OUT SUPPLY

I_VSOUT_norm	VS_OUT Consumption in Normal Mode	Normal mode, OUT1-3 off, floating		15	30	μA
I_VSOUT_stby	VS_OUT Consumption in Standby Mode	Standby mode, OUT1-3 off, floating, WU wakeup disabled, WU pin floating		0	2	μA
I_VSOUT_sleep	VS_OUT Consumption in Sleep Mode	Sleep mode, OUT1-3 off, floating, WU wakeup disabled, WU pin floating		0	2	μA
I_VSOUT_add_OUT	Added OUTx Drivers Current Consumption from VS_OUT	Normal mode, OUTx = floating, N = 1 - 3 ... number of OUTx drivers active		15 x N	90	μA
		Standby/Sleep mode, OUTx = floating, N = 1 - 3 ... number of OUTx drivers active		15 + 15 x N	120	μA
I_VSOUT_add_WU	Added WU Comparator Current Consumption from VS_OUT	WU pin floating		4	8	μA

VS + VS_OUT SUPPLY COMBINED CONSUMPTIONS

I_stby_cs	VS + VS_OUT Consumption in Standby Mode (with Cyclic Sense)	Standby mode, VS = VS_OUT = 12 V, VR1 on (not loaded), OUTx floating, driven by Timer1/2, bus communication off, No wake-up request pending, T _j = 25°C (Note 3)		(Note 4)		μA
I_sleep_cs	VS + VS_OUT Consumption in Sleep Mode (with Cyclic Sense)	Sleep mode, VS = VS_OUT = 12 V, VR1 off, OUTx floating, driven by Timer1/2, bus communication off, No wake-up request pending, T _j = 25°C (Note 3)		(Note 5)		μA
I_FailSafe	VS + VS_OUT Consumption in Fail-safe Mode	Fail-safe mode, OUTx floating, OUT3/FSO on		50	100	μA

3. Guaranteed by design.

4. Cyclic-sense Standby mode VS + VS_OUT consumption:

$$I_{standby_cs} (typ.) = I_{VS_standby} + I_{VSOUT_sleep} + I_{VS_standby_cs_add}$$

$$I_{standby_cs_add} (typ.) = 24.5 \mu A + (28 \mu A \cdot T_x_TON / T_x_TPER)$$

5. Cyclic-sense Sleep mode VS + VS_OUT consumption:

$$I_{sleep_cs} (typ.) = I_{VS_sleep} + I_{VSOUT_sleep} + I_{VS_sleep_cs_add}$$

$$I_{sleep_cs_add} (typ.) = 25.5 \mu A + (28 \mu A \cdot T_x_TON / T_x_TPER)$$

NCV7429

Table 5. ELECTRICAL CHARACTERISTICS (continued)

(6 V ≤ V_S ≤ 18 V, 6 V ≤ V_{S,out} ≤ 18 V, -40°C ≤ T_j ≤ 150°C; unless otherwise specified)

Symbol	Parameter	Conditions	Min	Typ	Max	Unit
VOLTAGE REGULATOR VR1						
V_VR1	Regulator Output Voltage	0 mA ≤ I(VR1) ≤ 150 mA, 6 V ≤ V _S ≤ 28 V, Cload_LIN ≥ 82 pF	4.9	5	5.1	V
		Under EMC exposure (Note 6, 7) Cload_LIN < 82 pF	4.85	5	5.15	V
Iout_VR1	Regulator Output Current	Maximum VR1 load current			150	mA
Ilim_VR1	Regulator Current Limitation	Maximum VR1 short current	240		600	mA
Isink_VR1	Regulator Sink Current	V(VR1) = 5.2 V	100			μA
Vdrop_VR1	Dropout Voltage	I(VR1) = 60 mA, V _S = 5 V		0.25	0.4	V
		I(VR1) = 60 mA, V _S = 4.5 V		0.3	0.5	
		I(VR1) = 30 mA, V _S = 4.5 V		0.2	0.4	
Loadreg_VR1	Load Regulation	1 mA ≤ I(VR1) ≤ 30 mA	-30		30	mV
Linereg_VR1	Line Regulation	I(VR1) ≤ 5 mA	-30		30	mV
Cload_VR1	VR1 Load Capacitor	ESR < 200 mΩ, ceramic capacitor recommended	1	2.2		μF
Icmp_VR1_rise	Current Comp. Rising Threshold	VR1 consumption increasing	0.8	2	3.1	mA
Icmp_VR1_fall	Current Comp. Falling Threshold	VR1 consumption decreasing	0.6	1.4	2.1	mA
Icmp_VR1_hys	Current Comp. Hysteresis			0.5		mA
Tfilt_VR1_Icmp	Current Comp. Filter Time			16		μs
Vfail_VR1	VR1 Fail Threshold	VR1 forced, VR1 decreasing	1.85	2	2.25	V
Tfail_VR1	VR1 Fail Blanking Time			5		μs
Tshort_VR1	VR1 Short Blanking Time	VR1 starting-up	34	40	46	ms
Ttsd_VR1	VR1 Deactivation Time after Thermal Shutdown 2		0.85	1	1.15	s
Toff_VR1	VR1 Off Time after 8 Watchdog Failures		170	200	230	ms

VR1 UNDER-VOLTAGE DETECTOR

VR1_RES1	VR1 Reset Threshold 1 (Default)	SPI VR1_RES.x = 00, VR1 voltage falling	4.45	4.65	4.8	V
VR1_RES2	VR1 Reset Threshold 2	SPI VR1_RES.x = 01, VR1 voltage falling	4.2	4.4	4.6	V
VR1_RES3	VR1 Reset Threshold 3	SPI VR1_RES.x = 10, VR1 voltage falling	3.8	4	4.2	V
VR1_RES4	VR1 Reset Threshold 4	SPI VR1_RES.x = 11, VR1 voltage falling	3.6	3.8	4	V
Tdel_VR1_RES	Reaction Delay between VR1 Undervoltage and NRES Low Pulse				40	μs
Tfilt_VR1_RES	VR1 Undervoltage Filter Time			16		μs

6. Based on characterization, Guaranteed by design.

7. DPI EMC coupled to LIN pin, Clin not used. Tested according to LIN Conformance Test Specification Package for LIN 2.1, October 10th, 2008.

NCV7429

Table 5. ELECTRICAL CHARACTERISTICS (continued)

 $(6\text{ V} \leq V_S \leq 18\text{ V}, 6\text{ V} \leq V_{S_out} \leq 18\text{ V}, -40^\circ\text{C} \leq T_j \leq 150^\circ\text{C}; \text{ unless otherwise specified})$

Symbol	Parameter	Conditions	Min	Typ	Max	Unit
HIGH-SIDE OUTPUTS OUT1-3						
Ron_OUT1_norm	On-Resistance to VS_OUT, "Normal-ohmic" Configuration	$T_j = 25^\circ\text{C}, I(\text{OUT1}) = -60\text{ mA}$		5		Ω
		$T_j = 150^\circ\text{C}, I(\text{OUT1}) = -60\text{ mA}$			13	Ω
Ron_OUT1_high	On-Resistance to VS_OUT, "High-ohmic" Configuration	$T_j = 25^\circ\text{C}, I(\text{OUT1}) = -6\text{ mA}$		20		Ω
		$T_j = 150^\circ\text{C}, I(\text{OUT1}) = -6\text{ mA}$			52	Ω
Ron_OUT2-3	On-Resistance to VS_OUT	$T_j = 25^\circ\text{C}, I(\text{OUT2-3}) = -60\text{ mA}$		5		Ω
		$T_j = 150^\circ\text{C}, I(\text{OUT2-3}) = -60\text{ mA}$			13	Ω
llim_OUT1_norm	Output Current Limitation to Ground, "Normal-ohmic" Configuration	$V(\text{OUT1}) = 0\text{ V}$	-330	-235	-140	mA
llim_OUT1_high	Output Current Limitation to Ground, "High-ohmic" Configuration	$V(\text{OUT1}) = 0\text{ V}$	-82	-58	-35	mA
llim_OUT2-3	Output Current Limitation to Ground	$V(\text{OUT2-3}) = 0\text{ V}$	-330	-235	-140	mA
luld_OUT1_norm	OUT1 Underload Threshold, "Normal-ohmic" Configuration		-6.5	-3.5	-0.8	mA
luld_OUT1_high	OUT1 Underload Threshold, "High-ohmic" Configuration		-1.5	-0.87	-0.2	mA
luld_OUT1-3	OUT2-3 Underload Threshold		-6.5	-3.5	-0.8	mA
lleak_OUT1-3	Output Leakage Current	$V_{S_OUT} = 28\text{ V}, V(\text{OUT1-3}) = 0\text{ V}$	-3			μA
Slew_OUT1-3	Slew Rate of OUT1-3	$V_{S_OUT} = 13.2\text{ V}, 140\text{ mA resistive load}$	0.2	0.5	0.8	V/ μs
Tblank_ULD_OUT1-3	Underload Detection Blanking Delay	OUT1-3 switched on	65	80	95	μs
Tfilt_ULD_OUT1-3	Underload Detection Filter Time		50	60	75	μs
Tfilt_ULD_OUT1-3	Overload Shutdown Filter Time		50	60	75	μs
LOW-SIDE RELAY OUTPUTS LS1/2						
Ron_LS1/2	On-Resistance to Ground	$T_j = 25^\circ\text{C}, I(\text{LS1/2}) = 100\text{ mA}$		1.5	3	Ω
		$T_j = 125^\circ\text{C}, I(\text{LS1/2}) = 100\text{ mA}$ (Note 8)			3.7	Ω
llim_LS1/2	Output Current Limitation	$\text{LS1/2} = V_{S_OUT}$	250	340	500	mA
		$\text{LS1/2} = V_{S_OUT} > 18\text{ V}$	200	290	450	mA
Vclamp_LS1/2	Output Clamp Voltage	$I(\text{LS1/2}) = 100\text{ mA}$	40		50	V
lleak_LS1/2	Output Leakage Current	$\text{LS1/2} = V_{S_OUT} = 16\text{ V}$			3	μA
Slew_LS1/2	Slew Rate of LS1/2	$V_{S_OUT} = 13.2\text{ V}, 100\text{ mA resistive load}$	0.2	2	4	V/ μs
Tfilt_ULD_LS1/2	Overload Shutdown Filter Time		50	60	75	μs
WAKE-UP INPUT WU						
Vth_down_WU	Wake-up Negative Edge Threshold Voltage	WU configurable as Source/Sink via SPI	0.4	0.5	0.6	V_{S_OUT}
Vth_up_WU	Wake-up Positive Edge Threshold Voltage		0.4	0.5	0.6	V_{S_OUT}
Vhyst_WU	Wake-up Threshold Hysteresis		100	300	500	mV
Ipullup_WU	Pullup Current	$1.5\text{ V} < V(\text{WU}) < V(V_{S_OUT} - 3\text{ V})$	-30	-20	-10	μA
Ipulldown_WU	Pulldown Current	$1.5\text{ V} < V(\text{WU}) < V(V_{S_OUT} - 3\text{ V})$	10	20	30	μA
Twu_WU	Minimum Time for Wake-up		50	64	85	μs

8. Based on characterization, Guaranteed by design.

NCV7429

Table 5. ELECTRICAL CHARACTERISTICS (continued)

(6 V ≤ V_S ≤ 18 V, 6 V ≤ V_{S,out} ≤ 18 V, -40°C ≤ T_j ≤ 150°C; unless otherwise specified)

Symbol	Parameter	Conditions	Min	Typ	Max	Unit
--------	-----------	------------	-----	-----	-----	------

MODE TRANSITION TIMING

Tdel_powerup	Transition Time from Power-up to Init	VS reaching VS_PORH to VR1 startup			15	μs
Tdel_norm_stdby	Transition Time from Normal/Flash to Standby Mode via SPI	CSN going high to Standby mode entry (Note 9)			10	μs
Tdel_norm_sleep	Transition Time from Normal/Flash to Sleep Mode via SPI	CSN going high to Sleep mode entry (Note 9)			10	μs
Tdel_stdby_norm	Delay of INTN Pulse in Standby after Wakeup				10	μs
Tdel_sleep_init	Transition from Sleep to Init Mode via Wakeup				10	μs

NRES AND INTN SIGNAL TIMING

T_NRES	NRES Low Pulse Duration, e.g. after a Watchdog Failure or VR1 Undervoltage		1.7	2	2.3	ms
T_INTN	INTN Low Pulse Duration after Wake-up Event		106	125	144	μs

DRIVER TIMING

Tdel_OUT1-3_on	Activation Delay of OUT1-3 Driver (from CSN rising edge)	VS_OUT = 13.2 V; V(OUT1-3) > 0.5·VS_OUT	12		40	μs
Tdel_OUT1-3_off	De-activation Delay of OUT1-3 Driver (from CSN rising edge)	VS_OUT = 13.2 V; V(OUT1-3) < 0.5·VS_OUT	20		55	μs
Tdel_LS1/2_on	Activation Delay of LS1/2 Driver (from CSN rising edge)	VS_OUT = 13.2 V; V(LS1/2) < 0.5·VS_OUT	17	42	85	μs
Tdel_LS1/2_off	De-activation Delay of LS1/2 Driver (from CSN rising edge)	VS_OUT = 13.2 V; V(LS1/2) > 0.5·VS_OUT	17	32	62	μs

INTERNAL PWM FOR DRIVERS CONTROL

f_PWM_lo	PWM Controller Frequency, Low Setting	FSEL_OUTx/LSx = 0	127	150	173	Hz
f_PWM_hi	PWM Controller Frequency, High Setting	FSEL_OUTx/LSx = 1	170	200	230	Hz

TIMER1/2 TIMING

Ttim_acc	Timer1/2 Period/On-time Accuracy (see CONTROL_2 register settings)	T1_TPER.[2:0], T1_TON, T2_TPER.[2:0], T2_TON.[1:0]	-15		+15	%
----------	--	---	-----	--	-----	---

9. Delays and slopes of LS1/2 drivers not included.

Table 5. ELECTRICAL CHARACTERISTICS (continued)

(6 V ≤ V_s ≤ 18 V, 6 V ≤ V_{s_out} ≤ 18 V, -40°C ≤ T_j ≤ 150°C; unless otherwise specified)

Symbol	Parameter	Conditions	Min	Typ	Max	Unit
SPI TIMING						
tCSN_SCLK	First SPI Clock Edge after CSN Active	(Note 10)	200			ns
tCSN_SDO	SDO Output Stable after CSN Active	C(SDO) = 100 pF (Note 10)			150	ns
tCSN_High	Inter-frame Space (CSN Inactive)	All SPI frames stored into internal registers (Note 10)	6			μs
tSCLK_High	Duration of SPI Clock High Level	(Note 10)	250			ns
tSCLK_Low	Duration of SPI Clock Low Level	(Note 10)	250			ns
tSCLK_per	SPI Clock Period	(Note 10)	1			μs
tSDI_set	Setup Time of SDI Input Towards SPI Clock	(Note 10)	100			ns
tSDI_hold	Hold Time of SDI Input Towards SPI Clock	(Note 10)	100			ns
tSCLK_SDO	SDO Output Stable after SPI Clock Falling Edge	C(SDO) = 100 pF (Note 10)			250	ns
t_SPI_exec	SPI Frame Execution Time	Time from CSN rising edge to execution of the frame			25	μs

10. Guaranteed by design; not tested in production.

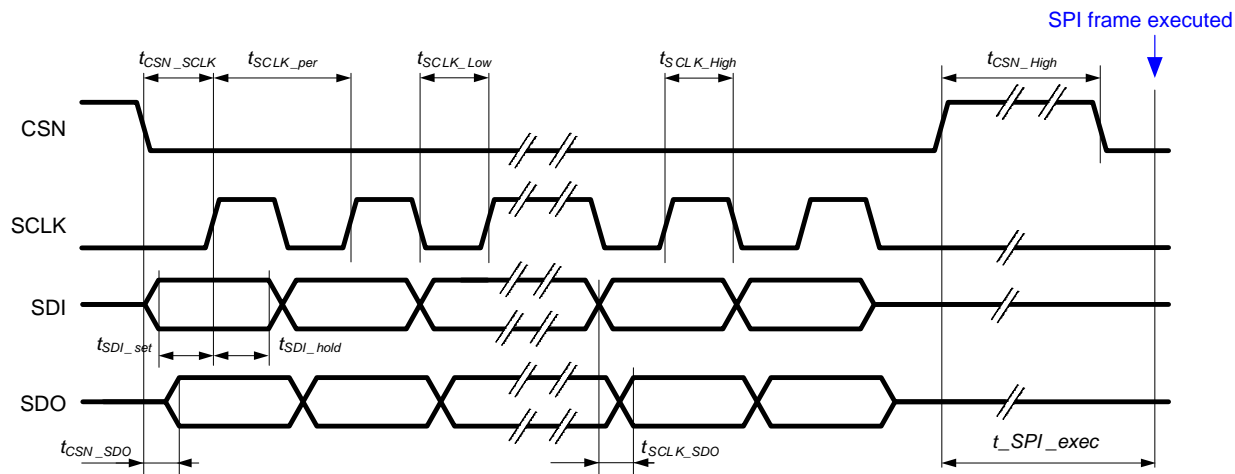

Figure 3. SPI Timing Parameters

Table 5. ELECTRICAL CHARACTERISTICS (continued)

(6 V ≤ V_S ≤ 18 V, 6 V ≤ V_{S,out} ≤ 18 V, -40°C ≤ T_j ≤ 150°C; unless otherwise specified)

Symbol	Parameter	Conditions	Min	Typ	Max	Unit
WATCHDOG TIMING						
Twd_acc	Watchdog Timing Accuracy		-15		+15	%
T_wd_TO	Timeout Watchdog Period; (watchdog is in the timeout mode after NRES release or in the Stand-by mode)		55	65	75	ms
T_wd_CW	Window Watchdog Closed Window	SPI WD_PER.x = 00		6		ms
		SPI WD_PER.x = 01		24		
		SPI WD_PER.x = 10		60		
		SPI WD_PER.x = 11		120		
T_wd_OW	Window Watchdog Open Window	SPI WD_PER.x = 00		10		ms
		SPI WD_PER.x = 01		40		
		SPI WD_PER.x = 10		100		
		SPI WD_PER.x = 11		200		
T_wd_trig	Window Watchdog Trigger Period via SPI (the safe trigger area)	SPI WD_PER.x = 00	6.9	9.75	13.6	ms
		SPI WD_PER.x = 01	27.6	39	54.1	
		SPI WD_PER.x = 10	69	97.5	136	
		SPI WD_PER.x = 11	138	195	272	
T_wd_TO_FLASH	Timeout Watchdog Period in Flash Mode	SPI WD_PER.x = 00	13.6	16	18.4	ms
		SPI WD_PER.x = 01	54.4	64	73.6	
		SPI WD_PER.x = 10	136	160	184	
		SPI WD_PER.x = 11	544	640	736	
T_wd_33_TO	WD_STATUS.1 bit Threshold of Timeout Length (in timeout mode)	Position inside T_wd_TO interval		33		%
T_wd_66_TO	WD_STATUS.0 bit Threshold of Timeout Length (in timeout mode)	Position inside T_wd_TO interval		66		%
T_wd_33_OW	WD_STATUS.1 bit Threshold of Open Window Length (in open window mode)	Position inside T_wd_OW interval		33		%
T_wd_66_OW	WD_STATUS.0 bit Threshold of Open Window Length (in open window mode)	Position inside T_wd_OW interval		66		%

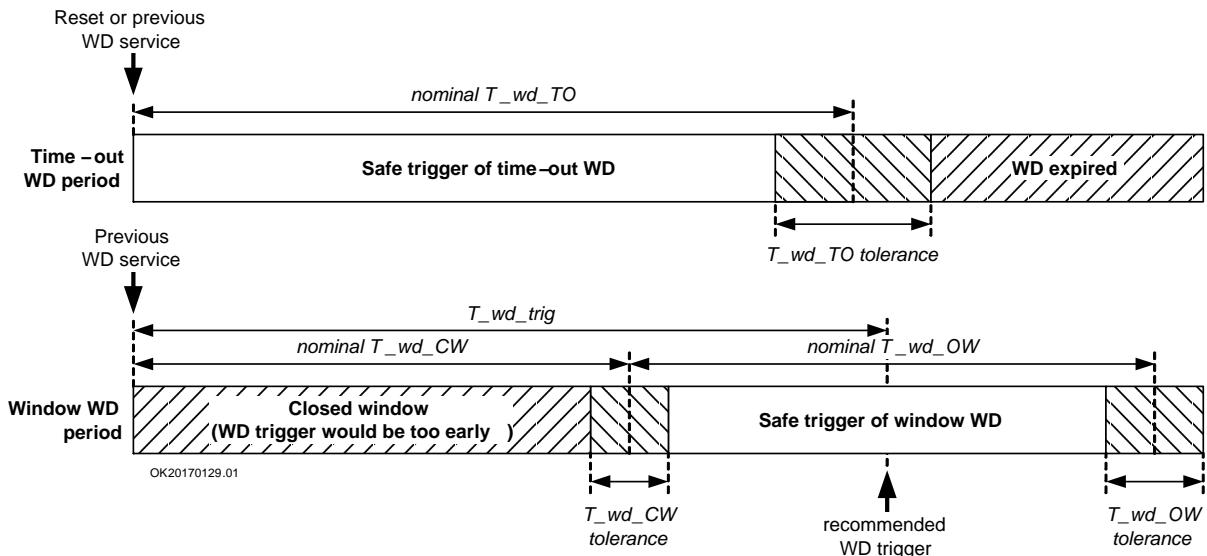

Figure 4. Watchdog Modes Timing

NCV7429

Table 5. ELECTRICAL CHARACTERISTICS (continued)

($6\text{ V} \leq V_s \leq 18\text{ V}$, $6\text{ V} \leq V_{s_out} \leq 18\text{ V}$, $-40^\circ\text{C} \leq T_j \leq 150^\circ\text{C}$; unless otherwise specified)

Symbol	Parameter	Conditions	Min	Typ	Max	Unit
--------	-----------	------------	-----	-----	-----	------

LIN TRANSMITTER DC CHARACTERISTICS

VLin_dom_LoSup	LIN Dominant Output Voltage	TxDL = low; VS = 7.3 V			1.2	V
VLin_dom_HiSup	LIN Dominant Output Voltage	TxDL = low; VS = 18 V			2	V
VLin_rec	LIN Recessive Output Voltage	TxDL = high; I(LIN) = 0 mA	VS - 1.5		VS	V
ILIN_lim	Short Circuit Current Limitation	V(LIN) = VS = 18 V	40		200	mA
Rslave_LIN	Internal Pull-up Resistance		20	33	47	kΩ

LIN RECEIVER DC CHARACTERISTICS

Vbus_dom_LIN	Bus Voltage for Dominant State				0.4	VS
Vbus_rec_LIN	Bus Voltage for Recessive State		0.6			VS
Vrec_dom_LIN	Receiver Threshold	LIN bus recessive → dominant	0.4		0.5	VS
Vrec_rec_LIN	Receiver Threshold	LIN bus dominant → recessive	0.5		0.6	VS
Vrec_cnt_LIN	Receiver Center Voltage	(Vrec_dom_LIN + Vrec_rec_LIN) / 2	0.475		0.525	VS
Vrec_hys_LIN	Receiver Hysteresis	(Vrec_rec_LIN - Vrec_dom_LIN)	0.05		0.175	VS
ILIN_off_dom	LIN Output Current, Bus in Dominant State	Normal mode, driver off; VS = 12 V; V(LIN) = 0 V	-1		-0.2	mA
ILIN_off_dom_slp	LIN Output Current, Bus in Dominant State	Sleep or Standby mode, driver off; VS = 12 V; V(LIN) = 0 V	-20	-15	-2	μA
ILIN_off_rec	LIN Output Current, Bus in Recessive State	Driver off; 8 V < VS < 18 V; 8 V < V(LIN) < 18 V; V(LIN) ≥ VS; Guaranteed by design			10	μA
ILIN_no_GND	Communication Not Affected	VS = GND = 12 V; 0 < V(LIN) < 18 V	-1		1	mA
ILIN_no_VS	LIN Bus Remains Operational	VS = GND = 0 V; 0 < V(LIN) < 18 V			5	μA

LIN TRANSMITTER DYNAMIC CHARACTERISTICS

D1	Duty Cycle 1 = tBUS_REC(min) / (2 × TBit)	THREC(max) = 0.744 × VS, THDOM(max) = 0.581 × VS, Tbit = 50 μs, VS = 7 V to 18 V; L1-L3 (Note 11)	0.396		0.5	
D2	Duty Cycle 2 = tBUS_REC(max) / (2 × TBit)	THREC(min) = 0.422 × VS, THDOM(mi) = 0.284 × VS, Tbit = 50 μs, VS = 7.6 V to 18 V; L1-L3 (Note 11)	0.5		0.581	
D3	Duty Cycle 3 = tBUS_REC(min) / (2 × TBit)	THREC(max) = 0.788 × VS, THDOM(max) = 0.616 × VS, Tbit = 96 μs, VS = 7 V to 18 V; L1-L3 (Note 11)	0.417		0.5	
D4	Duty Cycle 4 = tBUS_REC(max) / (2 × TBit)	THREC(min) = 0.389 × VS, THDOM(min) = 0.251 × VS, Tbit = 96 μs VS = 7.6 V to 18 V; L1-L3 (Note 11)	0.5		0.59	

Table 5. ELECTRICAL CHARACTERISTICS (continued)

(6 V ≤ V_s ≤ 18 V, 6 V ≤ V_{s,out} ≤ 18 V, -40°C ≤ T_j ≤ 150°C; unless otherwise specified)

Symbol	Parameter	Conditions	Min	Typ	Max	Unit
LIN TRANSMITTER DYNAMIC CHARACTERISTICS						
T_fall_LIN	LIN Falling Edge	VS = 12 V; L1, L2 (Note 11); Normal slope mode			22.5	μs
T_rise_LIN	LIN Rising Edge	VS = 12 V; L1, L2 (Note 11); Normal slope mode			22.5	μs
T_sym_LIN	LIN Slope Symmetry	VS = 12 V; L1, L2 (Note 11); Normal slope mode	-4	0	4	μs
T_fall_norm_LIN	LIN Falling Edge	VS = 12 V; L3 (Note 11); Normal slope mode			27	μs
T_fall_low_LIN	LIN Falling Edge	VS = 12 V; L3 (Note 11); Low slope mode			62	μs
T_rise_norm_LIN	LIN Rising Edge	VS = 12 V; L3 (Note 11); Normal slope mode			27	μs
T_rise_low_LIN	LIN Rising Edge	VS = 12 V; L3 (Note 11); Low slope mode			62	μs
T_sym_norm_LIN	LIN Slope Symmetry	Normal mode; VS = 12 V; L3 (Note 11)	-5	0	5	μs
T_TxDL_timeout	TxDL Dominant Time-out Selected by SPI bits TxDL_TO	SPI setting TxDL_TO[1:0]="00"	27	55	70	ms
		SPI setting TxDL_TO[1:0]="01"	6	13	20	
		SPI setting TxDL_TO[1:0]="1X"		disabled		
C_LIN	Capacitance of the LIN Pin	Guaranteed by design; not tested in production		20	30	pF

LIN RECEIVER DYNAMIC CHARACTERISTICS

Trec_prop_down	Propagation Delay of Receiver Falling Edge	C(RxDL) = 20 pF			6	μs
Trec_prop_up	Propagation Delay of Receiver Rising Edge	C(RxDL) = 20 pF			6	μs
Trec_sym	Propagation Delay Symmetry	Trec_prop_down – Trec_prop_up, C(RxDL) = 20 pF	-2		2	μs
T_LIN_wake	Dominant Duration for Wakeup		30	90	150	μs

11. The following bus loads are considered: L1 = 1 kΩ/1 nF; L2 = 680 Ω/6.8 nF; L3 = 500 Ω/10 nF.

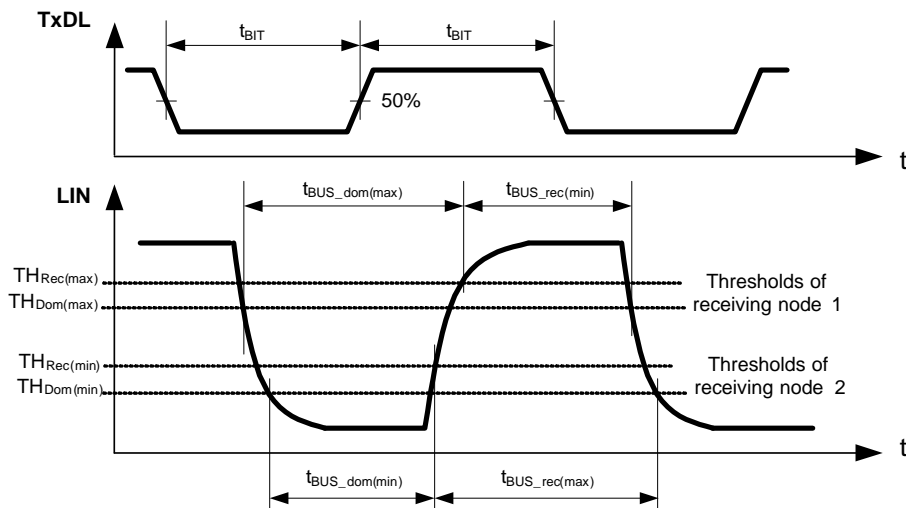

Figure 5. LIN Dynamic Characteristics – Duty Cycles

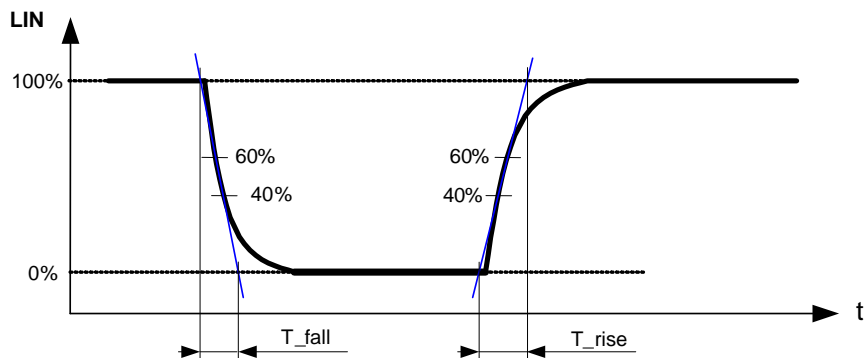

Figure 6. LIN Dynamic Characteristics – Transmitter Slope

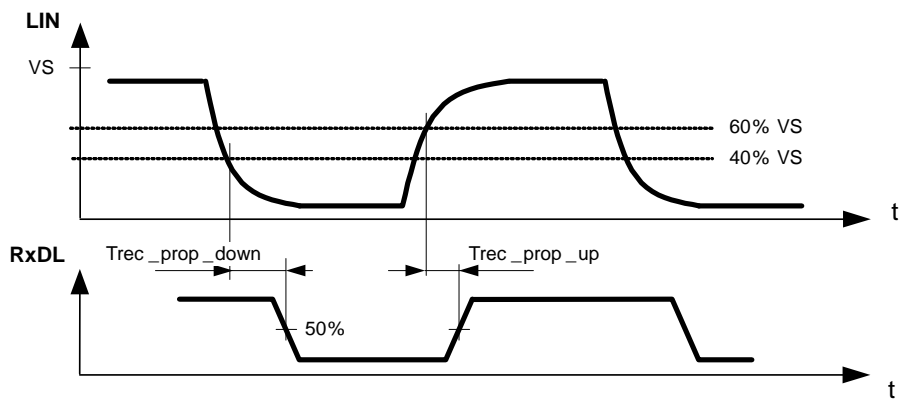

Figure 7. LIN Dynamic Characteristics – Receiver

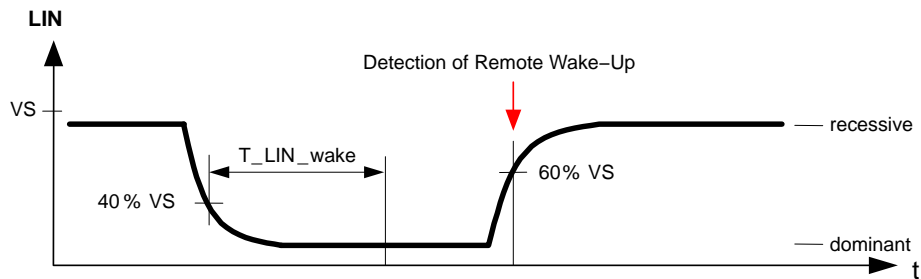

Figure 8. LIN Wakeup

NCV7429

Table 5. ELECTRICAL CHARACTERISTICS (continued)

($6\text{ V} \leq V_s \leq 18\text{ V}$, $6\text{ V} \leq V_{s_out} \leq 18\text{ V}$, $-40^\circ\text{C} \leq T_j \leq 150^\circ\text{C}$; unless otherwise specified)

Symbol	Parameter	Conditions	Min	Typ	Max	Unit
--------	-----------	------------	-----	-----	-----	------

DIGITAL OUTPUTS RXDL/INTN, SDO

IoutL_pinx	Low-level Output Driving Current	pinx is logical Low, forced $V(\text{pinx}) = 0.4\text{ V}$	2	5	12	mA
IoutH_pinx	High-level Output Driving Current	pinx is logical High, forced $V(\text{pinx}) = VR1 - 0.4\text{ V}$	-12	-5	-2	mA
Ileak_HZ_pinx	Leakage in the Tristate, Pin SDO	pinx in the HZ state, forced $0\text{ V} < V(\text{pinx}) < VR1$	-5		5	μA

DIGITAL OUTPUT NRES

IoutL_NRES	Low-level Output Driving Current	NRES is active (logical Low), forced $V(\text{NRES}) = 0.4\text{ V}$	2	5	12	mA
VoutL_NRES	Low-level Output Voltage, Low $VR1/VS$	$VR1 > 2\text{ V}$, $VS < VR1$, $I(\text{NRES}) = 0.1\text{ mA}$			0.4	V
		$VS > 2\text{ V}$, $I(\text{NRES}) = 0.1\text{ mA}$			0.4	V
Rpullup_NRES	Internal Pull-up Resistor to $VR1$		55	100	185	$\text{k}\Omega$

DIGITAL INPUTS SWDM, TXDL, SDI, SCLK, CSN

VinL_pinx	Low-level Input Voltage		0		0.8	V
VinH_pinx	High-level Input Voltage		2		$VR1$	V
Vin_hys_pinx	Input Voltage Hysteresis		100		500	mV
Vin_SWDM	SWDM Pin Threshold Voltage		7	8.5	10	V
Vin_hys_SWDM	SWDM Pin Threshold Hysteresis		10	200	300	mV
Rpullup_pinx	Internal Pull-up Resistor to $VR1$; Pins TxDL, CSN		55	100	185	$\text{k}\Omega$
Rpulldown_pinx	Internal Pull-down Resistor to Ground; Pins SWDM, SDI, SCLK		55	100	185	$\text{k}\Omega$

THERMAL PROTECTION

Tjw	Thermal Warning Level		125	135	145	$^\circ\text{C}$
Tjsd1	Thermal Shutdown Level 1		135	147	160	$^\circ\text{C}$
Tjsd2	Thermal Shutdown Level 2		145	159	175	$^\circ\text{C}$
Tjsd1-Tjw	Thermal Warning and Thermal Shutdown 1 Level Distance		5	12		$^\circ\text{C}$
Tjsd2-Tjsd1	Thermal Shutdown 1 and Thermal Shutdown 2 Levels Distance		5	12		$^\circ\text{C}$

Product parametric performance is indicated in the Electrical Characteristics for the listed test conditions, unless otherwise noted. Product performance may not be indicated by the Electrical Characteristics if operated under different conditions.

FUNCTIONAL DESCRIPTION

The NCV7429 is a monolithic LIN System-Basis-Chip with enhanced feature set useful in automotive body control systems. Besides the LIN bus interface, the IC features a 5 V voltage regulator, several high-side and low-side switches to control LEDs and relays plus supervision functionality like a window watchdog. This allows a highly integrated solution by replacing external discrete components while maintaining the valuable flexibility. Due to this the board space and ECU weight can be minimized to the lowest level.

POWER SUPPLY AND REGULATORS

VS/VS_OUT – Main Power Supply

VS pin is the main power supply of the device, while VS_OUT supplies OUT1–3 drivers and WU input. In the application, it will be typically connected to the KL30 or KL15 car node. It is necessary to provide an external reverse-polarity protection and filtering capacitor on the VS supply (see Figure 2).

VS/VS_OUT supplies are monitored with respect to the following events:

- VS power-on reset is detected as a crossing of VS_POR level. When VS remains below VS_POR, the device is passive and provides no functionality, the SPI registers are reset to their default values. When VS rises above VS_PORH, the device starts following its state diagram through the power-up state. This event is latched in the SPI bit “COLD_START” so that the application software can detect the VS connection.
- VS_OUT Under-Voltage is detected when VS_OUT falls below VS_OUT_UV threshold (typ. 5.5 V). A VS_OUT under-voltage can be encountered, for example, with a discharged car battery or during engine cranking. The high-side and low-side drivers are typically forced off. The exact driver reaction depends on the SPI control settings – see par. “VS_OUT Over- and Under-Voltage”. Under-voltage events are flagged through SPI bit “VS_OUT_UV”.
- VS_OUT Over-Voltage is detected when VS_OUT rises over VS_OUT_OV threshold (typ. 21 V). Similarly to the under-voltage, the high-side and low-side drivers are de-activated based on the SPI settings and the event is flagged through SPI bit “VS_OUT_OV”.

GND1, GND2 – Ground Connections

The device ground connection is split to two pins – GND1 and GND2. Both pins have to be connected on the application PCB.

Regulator VR1

VR1 is a low-drop output regulator providing 5 V voltage derived from the VS main supply. It is able to deliver up to 150 mA and is primarily intended to supply the application

microcontroller unit (MCU) and related 5 V loads (e.g. its own MCU-related digital inputs/outputs). An external capacitor needs to be connected on VR1 pin in order to ensure the regulator’s stability and to filter the disturbances caused by the connected loads. Ceramic X7R 2.2 μ F capacitor is recommended.

VR1 voltage is supplying all digital low-voltage input/output pins.

The protection and monitoring of the VR1 regulator consist of the following features:

- VR1 Current Limitation – the current protection ensures fast enough charging of the external capacitor at start-up while protecting the regulator in case of shorts to ground
- Junction Temperature Monitor – the junction temperature is monitored and when it rises above the second shutdown level, the VR1 regulator is de-activated and the device is forced to the Fail-safe mode in order to protect the regulators and the full application. For details, see par. “Thermal Protection”.
- VR1 Failure Comparator – during the VR1 start-up and operation, the VR1 voltage is continuously compared with V_{fail_VR1} level (typ. 2 V). During startup, if VR1 does not rise above V_{fail_VR1} level within T_{short_VR1} (typ. 40 ms), it’s considered shorted to ground and the device is forced to the Fail-safe mode (see Figure 10). During the VR1 operation, any dip below V_{fail_VR1} level longer than T_{fail_VR1} (typ. 5 μ s) is considered as a failure – temporary excursions of VR1 under the failure threshold can be caused, for example, by EMC, and can lead to memory data inconsistencies inside the MCU. Both the failure during VR1 startup and the operation are latched in the “VR1_FAIL” SPI bit for subsequent software diagnostics.
- VR1 Reset Comparator – the VR1 regulator output is compared with a reset level $VR1_RES$ (programmable to typ. 74%, 79%, 87% and 91% of the nominal VR1 voltage). If the VR1 level drops below this level for longer than $T_{filt_VR1_RES}$ (typ. 16 μ s), a reset towards the MCU is generated through the NRES pin and all outputs (OUT1–3, LS1/2) are switched off and all the control registers are set to their defaults, except “FSO_DIS” bit setting (see Figure 11).
- VR1 Consumption Monitor (I_{cmp}) – to ensure a safe transition into the Standby mode, where VR1 remains active while the watchdog is off, the VR1 current consumption is monitored. The watchdog is really disabled in the Standby mode only when the VR1 consumption falls below $I_{cmp_VR1_fall}$ (typ. 1.1 mA). An increase of the VR1 consumption above the $I_{cmp_VR1_rise}$ level activates the watchdog again.

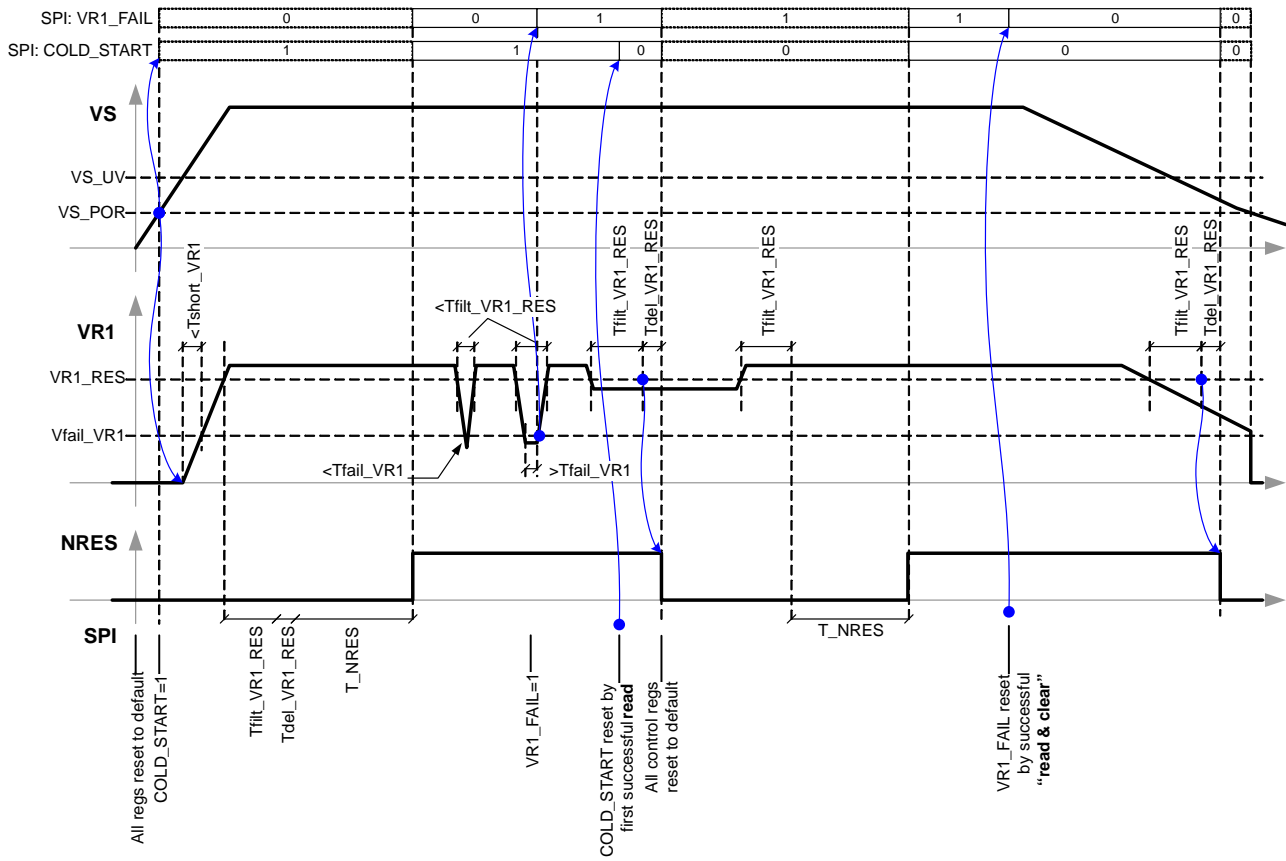

Figure 9. VR1 Monitoring

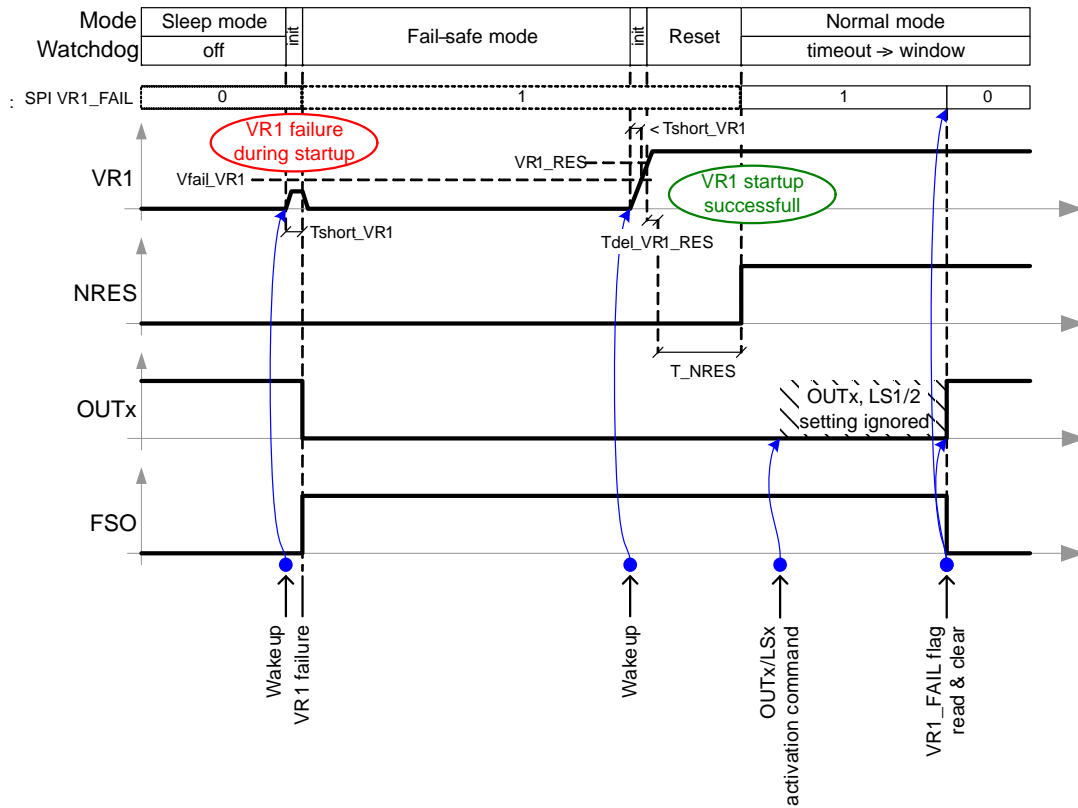

Figure 10. VR1 Monitoring - VR1 Failure during Startup

NCV7429

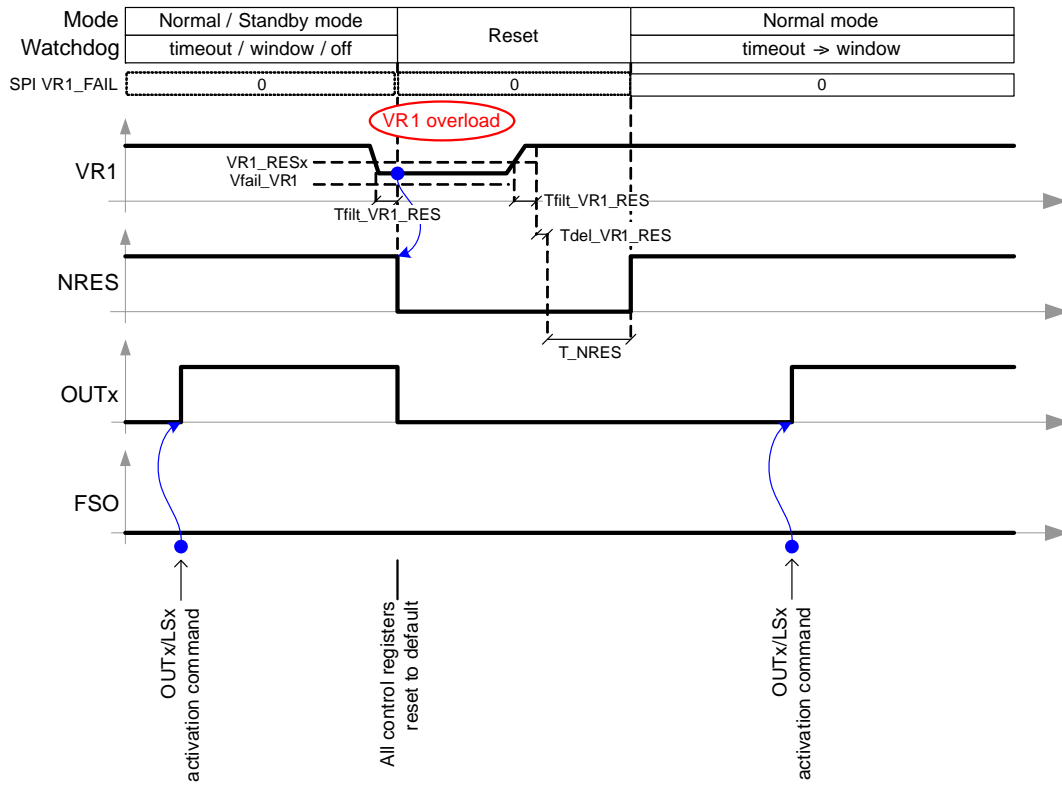

Figure 11. VR1 Monitoring – VR1 Undervoltage

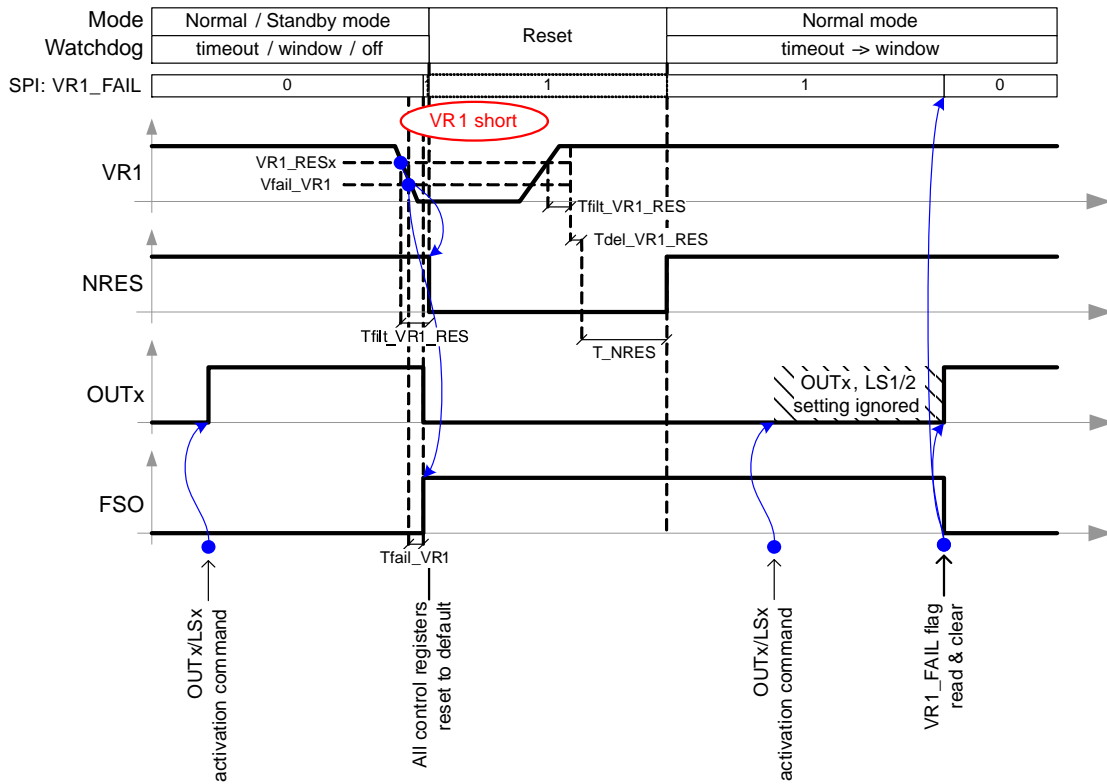

Figure 12. VR1 Monitoring – VR1 Short in Normal/Standby Mode

COMMUNICATION TRANSCEIVER

LIN Transceiver

The NCV7429 on-chip LIN transceiver is an interface between a physical LIN bus and the LIN protocol controller. It is compatible to LIN2.x and J2602 specifications.

The LIN is supplied solely from the VS pin and its state control is as follows:

- In the **Normal mode** of the device, LIN transceiver transmits dominant or recessive symbols on the LIN bus based on the logical level on TxDL pin. The signal received from the bus is indicated on RxDL pin. Both logical pins are referred to the VR1 supply. A resistive pull-up path of typ. 30 k Ω is internally connected between LIN and VS.
- In the **Standby and Sleep mode** of the device, the LIN transceiver is in its wakeup detection state. Logical level on TxDL is ignored and pin RxDL is kept high until it's used as an interrupt request signal. A LIN bus wakeup corresponds to a dominant symbol at least T_{LIN_wake} long (typ. 90 μ s) followed by a rising edge (i.e. transition to recessive) – see Figure 8. In this way, false wakeups due to permanent LIN dominant failures are avoided. Only a pull-up current of typ. 15 μ A is connected between VS and LIN instead of the 30 k Ω pull-up path. The LIN wakeup detection is by default active in the Standby and Sleep modes and can be disabled via SPI control registers.

The LIN transceiver features SPI-configurable **TxDL dominant time-out timer**. This circuit, if enabled, prevents the bus lines being driven to a permanent dominant state (blocking all network communication) if pin TxDL is forced permanently low by a hardware and/or software application failure. The timer is triggered by a negative edge on pin TxDL. If the duration of the low-level on pin TxDL exceeds the internal timer value $T_{TxDL_timeout}$, the transmitter is disabled, driving the bus into a recessive state and the event is latched in the SPI status bit “TO_TxDL”. The transmission is de-blocked when “TO_TxDL” bit is reset by the corresponding register “read and clear” and TxDL pin returns to high (recessive) state.

The LIN transceiver provides two LIN slope control modes, configured by SPI bit “LIN_SLOPE”.

In **normal slope mode** the transceiver can transmit and receive data via LIN bus with speed up to 20 kBaud according LIN2.x specification. This mode is used by default.

In **low slope mode** the slew rate of the signal on the LIN bus is reduced (rising and falling edges of the LIN bus signal are longer). This further reduces the EMC emission. As a consequence the maximum speed on the LIN bus is reduced up to 10 kBaud. This mode is suited for applications where the communication speed is not critical. The low slope mode can be configured by setting SPI bit “LIN_SLOPE”.

HIGH- AND LOW-SIDE DRIVERS

High-Side Drivers OUT1–3

High-side drivers OUT1–OUT3 are designed to supply mainly LED's or switches (for cyclic monitoring). When switched on, they connect the corresponding pin to the VS_OUT supply. Driver OUT1 can be configured to have two distinct levels of on-resistance; typically 5 Ω in “normal-ohmic” configuration (default) and typically 20 Ω in “high-ohmic” configuration. Drivers OUT2–3 have a typical on-resistance of 5 Ω .

At the VS power-up or wakeup from the Sleep mode, all OUT1–3 drivers are off. Immediately after the device enters the Normal mode, they can be set to one of the following states via the corresponding SPI bits:

- Driver is off in all modes (default)
- Driver is on in all modes, except Fail-safe mode
- Driver is activated periodically in all modes, except Fail-safe mode. The periodicity is driven either by Timer 1 (period from 0.5 sec to 4 sec, on time 10 ms or 20 ms) or Timer 2 (period from 10 ms to 200 ms, on time 100 μ s, 200 μ s, 1 ms or 5 ms). Periodical activation can be used, for example, for LED flashing or cyclic contact monitoring.
- Driver is controlled by the on-chip PWM controller in all modes, except Fail-safe mode. Each OUTx driver has a dedicated 7-bit PWM duty cycle and the base frequency selectable through individual SPI settings.

The SPI settings for the drivers are applied immediately after the SPI frame is successfully completed (CSN rising edge) as long as FSO is not active. This can be done even immediately after the device initialization before the first watchdog service.

All OUTx outputs are protected by the following features:

- Over-current protection and current limitation: if the driver current exceeds the over-current limit for longer than $T_{filt_OLD_OUTx}$ (typ. 60 μ s), the event is latched into the SPI status bits and the driver is disabled. It will be again enabled only when the corresponding SPI flag is read and cleared. The over-current event in the Standby or Sleep mode causes the interrupt in case SPI bit “WU_OC” is set.
- Under-load detection: during the on-time of the driver, a too low current indicates missing load. The under-load event is latched into the corresponding SPI status bits; however, the driver is not disabled and remains controlled according the SPI bits.
- Thermal protection and VS_OUT under/over-voltage protection: through monitoring of the junction temperature and the VS_OUT supply voltage; all loads are protected as described in par. “Protection”. If SPI bit “WU_TSD” resp. “WU_OVUV” is set, the thermal shutdown 1 event resp. VS_OUT over-/under-voltage in the Standby or Sleep mode causes the interrupt.

OUT3 output is also intended for failure indication. By default, OUT3 switch is not controlled by the SPI settings but by the internal FSO signal – see section “Fail-Safe (FSO) Signal”. Only when the FSO signal is disconnected from OUT3 by setting SPI bit “FSO_DIS”, OUT3 acts identically to OUT1 and OUT2.

Low-Side Drivers LS1/2

NCV7429 offers two low-side drivers LS1 and LS2 primarily intended to drive relays, typically:

- R = 160 Ω ± 10%, L = 240/300 mH
- R = 220 Ω ± 10%, L = 330/420 mH

For the relay demagnetization, LS1/2 drivers feature active flyback clamps towards ground (no diode to VS_OUT) allowing to keep the load off even under load-dump condition on VS_OUT. Alternatively, LS1/2 can drive LED's.

LS1/2 can be configured in one of the following states:

- Off in all modes (default)
- On in the Normal mode; off in all other modes
- Controlled by individual PWM in the Normal mode; off in all other modes. If a relay is connected to the output, this setting should not be used.

LS1/2 outputs are protected by the following features:

- Over-current protection and current limitation: if the driver current exceeds the over-current limit for longer than $T_{filt_OLD_LS1/2}$ (typ. 60 μs), the event is latched into the SPI status bits and the driver is disabled. It will be again enabled only when the corresponding SPI flag is read and cleared.
- Thermal protection and VS_OUT under/over-voltage protection: through monitoring of the junction temperature and the VS_OUT supply voltage; all loads are protected as described in par. “Protection”.

WAKEUP INPUT WU

NCV7429 offers an independent contact-monitoring input WU which can be used either for Normal-mode contact polling or for contact change detection during the Standby and Sleep modes. In any mode, the WU input can be configured into one of the following modes of operation:

- Static sense: the WU input is constantly monitored by an input comparator and a filter of typ. 64 μs. In the Normal mode, the result of the comparison (the input high/low state) can be polled any time through the SPI status bits. In the Standby and Sleep modes, a change of the WU polarity (in any direction) is recognized as a wakeup event. The MCU can then recognize the exact WU wakeup source by reading “WU_WU” SPI status bits.
- Cyclic sense: the WU state detection is performed periodically as fostered by one of the internal timers: Timer 1 (period from 0.5 sec to 4 sec) or Timer 2

(period from 10 ms to 200 ms). WU is left to settle during the on-time and the state detection is started 20 μs before the on-time end through a filter of typ. 16 μs. The result of the periodical state detection is latched into the SPI status register and is not updated until the next period of the selected timer. A wakeup is detected in case sample of the WU state changes in any direction.

Additionally, the WU input can be internally pre-biased through individual control bits by a pull-down (WU_PUD=0) or pull-up (WU_PUD=1) current source. The pre-bias is disabled in Standby or Sleep mode if WU wakeup is disabled (WU_DIS=1).

In case cyclic sense is used, the WU timer settings must be correctly chosen together with the high-side output settings. The driver physically ensuring the periodical contact supply must be set for the same timer as the contact monitor by the MCU software.

OPERATING MODES

NCV7429 can be configured to different operating modes in function of the application needs and the external conditions. The device resources can be enabled/disabled and the overall power consumption can be adapted to the electronic module state – ranging from full power mode down to a very low quiescent current “sleep” mode. The principal operating modes of NCV7429 are shown in Figure 13.

Un-Powered and Init Modes

As long as VS remains below the VS_POR level (typ. 3.45 V), the device is held in power-up reset. All outputs except NRES are in HiZ state, the linear regulator output is off.

As soon as the VS main supply exceeds the power-on reset level, the device enters an initialization sequence represented by a transient “init” mode. All SPI registers are set to their default values, “COLD_START” SPI bit is set high for subsequent diagnostics and the VR1 regulator is started. After a successful start of the VR1 regulator (i.e. VR1 exceeds the V_{fail_VR1} level in less than T_{short_VR1} – typ. 40 ms), NRES is still kept low until VR1 reaches its reset level. After another 2 ms (parameter T_{NRES}), NRES is released to high and the device enters Normal mode with timeout watchdog.

In case VR1 does not start within T_{short_VR1} , it's again disabled, SPI “VR1_FAIL” bit is set and the device enters Fail-safe mode. The Fail-safe mode can be exited via any valid wakeup event or by VS re-connection. The initialization sequence is shown in Figure 12.

During Init phase, the SWDM input is sampled. In case SWDM is High, the Software Development mode is entered and watchdog is disabled in all modes until the following Init mode. SWDM pin can be sampled upon SPI request as well.

Normal Mode

In this mode the device provides full functionality, all resources are available. The voltage regulator VR1 is able to source 150 mA. MCU can enable/disable the device features via SPI as well as monitor the status of the device.

VR1 level is monitored through reset and failure comparators – see Figure 12. When the Normal mode is entered, the watchdog is started in a timeout mode; a window watchdog mode is applied after the first correct watchdog service. The watchdog has to be correctly triggered; otherwise a watchdog failure is detected resulting in reset signal to the MCU. Afterwards, the watchdog is re-started in the timeout mode. After eight consecutive watchdog failures, the VR1 regulator is disabled for 200 ms and re-started again. If the watchdog service still fails seven more times, the device is put into Fail-safe mode. The Fail-safe mode can then be exited either via a wakeup or VS re-connection.

Through SPI bits “MODE[1:0]”, the MCU can either keep the device in the Normal mode, or request transition into one of the low-power modes – Standby or Sleep.

Standby Mode

Standby mode is the first low-power mode. The voltage regulator VR1 remains active while the watchdog is disabled. The Standby mode is mainly intended to keep the application powered (e.g. for RAM content preservation) while the MCU is in a halt-state (software not running).

In order to make a safe transition into the Standby mode, the watchdog will remain enabled even in the Standby mode until the consumption from VR1 decreases below *I_{cmp_VR1_fall}* level (typ. 1.1 mA). When the VR1 consumption increases back above *I_{cmp_VR1_rise}* level (typ. 1.7 mA), the device will perform a wakeup from the Standby mode to ensure supervision of the MCU software. The current supervision of VR1 can be disabled via SPI by setting the bit “ICMP_STBY”.

During the Standby mode, several types of wakeup events can be signaled to the MCU through INTN pin: timer1 or timer2 expiration, wakeup on LIN bus, change on WU pin or SPI activity. SPI activity wakeup is not signaled through INTN pin. The watchdog is started in timeout mode and MCU can request a mode transition afterwards. VR1 also continues to be monitored by the reset circuit, which will generate a low NRES pulse in case the regulator output drops below the reset level.

Sleep Mode

Sleep mode is the mode with the lowest consumption. VR1 regulator and the watchdog are inactive. The device maintains minimum operation allowing reception of wake-up events generated by WU input, LIN bus line, or driven by timer1 or timer2. In case of a wake-up event, the device switches from the Sleep mode to the Normal mode (through the Init mode, as the VR1 must be started similarly to the VS power-up). SPI bit WD_TRIG is set to 0 after a wakeup.

Fail-Safe Mode

Fail-safe mode is the mode equals to the Sleep mode, but all peripherals (VR1, OUT1–3, LS1/2) and the watchdog are inactive.

The Fail-safe mode is entered after following failure conditions:

- VR1 did not reach *V_{fail_VR1}* level (typ. 2 V) within *T_{short_VR1}* during startup (VS connection or wakeup from Sleep mode)
- Fifteen consecutive watchdog failures occur
- The device junction temperature exceeded thermal shutdown level *T_{jsd2}* (typ. 155°C) for eight times within one minute

Wakeup from Fail-safe mode is indicated by SPI flag “FAIL-SAFE”.

Flash Mode

Flash mode is identical to the Normal mode with the exception of the watchdog which operates in timeout mode. The purpose of the Flash mode is to enable transfer of bigger bulk of data between the MCU and a programming interface – typically in the field. The Flash mode is entered by setting dedicated SPI bit FLASH_RDY in CONTROL_2 register followed by “MODE[1:0]” = 11b request.

Software Development Mode

Software Development mode is identical to the Normal mode with the exception of the watchdog which is disabled. The purpose of the Software Development mode is to enable software debugging without watchdog interaction or transfer of bigger bulk of data between the MCU and a programming interface – typically during the module-level production.

The Software Development mode will be entered if the voltage applied on SWDM pin exceeds the corresponding comparison level *V_{in_SWDM}* in the Init phase or is SWDM sampling is requested by “SWDM_SAMP” SPI bit. Sampled SWDM state is latched in read-only “SWDM” SPI bit. As SWDM pin is high-voltage tolerant, it might be tied to the VS line through a protection resistor.

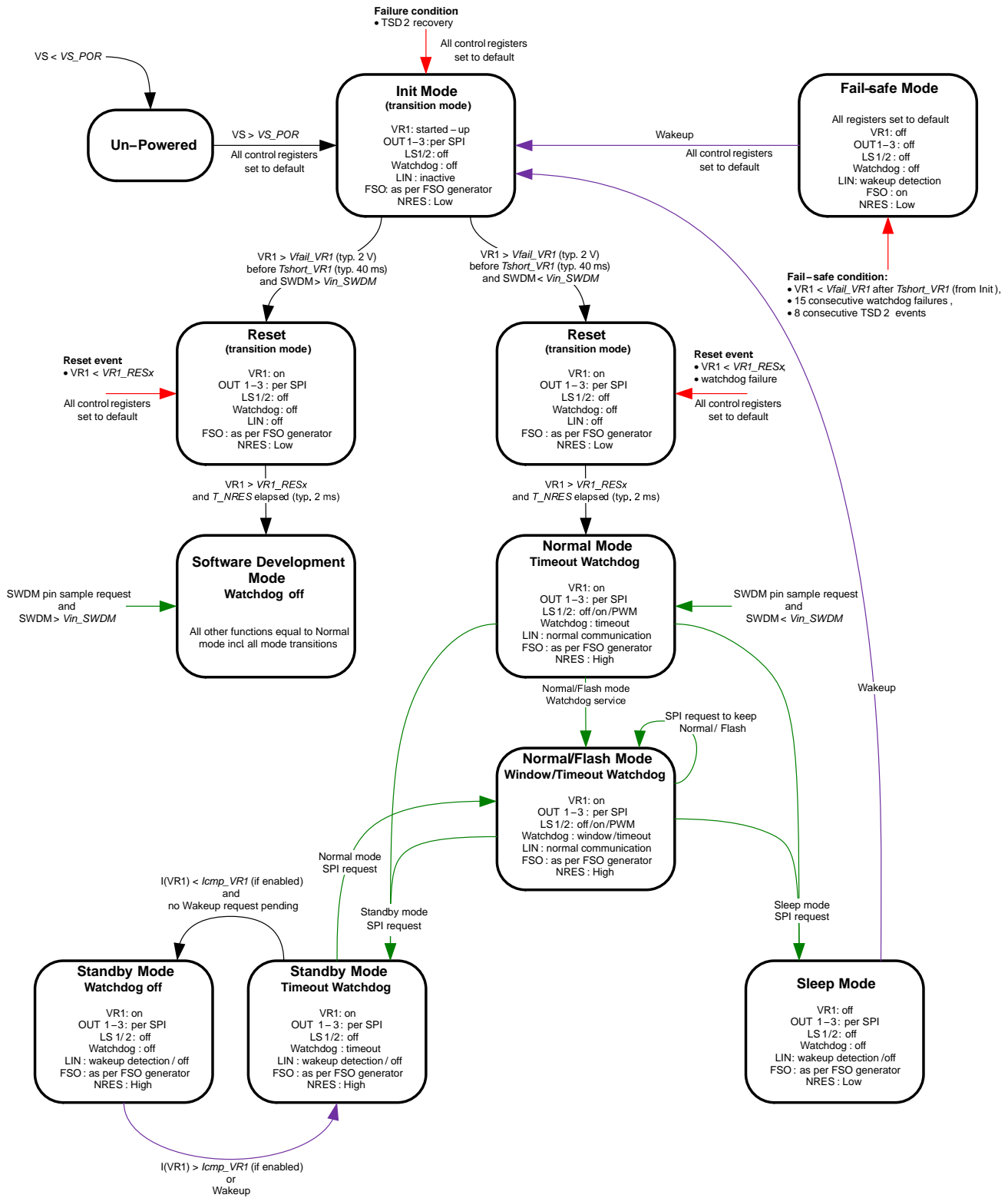

Figure 13. Principal Operating Modes

WAKE-UP EVENTS

In the Standby and Sleep modes, NCV7429 can detect several types of wake-up events summarized in Table 6:

- In the Sleep mode, a wakeup will cause initialization of VR1 regulator and transition to a Reset mode. After the release of the NRES signal, the timeout watchdog will be started and the device enters the Normal mode – i.e. the SPI settings for outputs will be applied immediately. The following events will cause wakeup from the Sleep mode:
 - ◆ Bus wakeup through LIN – can be enabled/disabled through SPI.
 - ◆ Switch monitoring on WU input – can be configured and enabled/disabled through SPI.
 - ◆ Timer wakeup – timer1 and timer2 can be configured to cause a wakeup after a fixed time period – the selected timer is started at the moment the Sleep mode is requested and causes wakeup immediately when the selected time period expires. The timer wakeup can be configured and enabled/disabled by SPI.
 - ◆ Thermal shutdown 1 – enabled if “WU_TSD” is set.
 - ◆ OUT1–3 overcurrent – enabled if “WU_OC” is set.
 - ◆ VS_OUT over-/under-voltage – enabled if “WU_OVUV” is set.
- From the Standby mode, where VR1 remains active, a wakeup event will cause watchdog startup in timeout mode:
 - ◆ SPI wakeup (CSN low and rising edge on SCLK). Interrupt request is not generated.
 - ◆ VR1 consumption wakeup (VR1 consumption exceeds the *Icmp_VR1_rise* level; can be disabled by SPI control). Interrupt request is generated. If VR1 consumption falls below the *Icmp_VR1_fall* level within the timeout period, the watchdog is disabled again.
 - ◆ Bus wakeup through LIN, switch monitoring on WU, timer wakeups, thermal shutdown 1, OUT1–3 overcurrent and VS_OUT over-/under-voltage have the same meaning as in the Sleep mode. Any of them will cause an interrupt request, if enabled.

Every valid wakeup event starts the timeout watchdog, which then must be correctly triggered. If another wakeup event occurs during the initial timeout watchdog, the watchdog is not re-started and another interrupt request (pulse on INTN pin) is generated only if the corresponding wakeup flag is located in different status register. E.g., LIN wakeup will start the watchdog timeout timer while the device remains in the Standby mode. If, for example, a WU pin wakeup is then detected, it will be latched into the SPI registers, but no new interrupt will be generated and the watchdog will keep running. If VS_OUT overvoltage is detected afterwards, new interrupt will be generated. This example is shown in Figure 14 and Figure 15.

In all wakeup cases in the Standby mode, the device remains in the Standby mode with watchdog running until it is changed. SPI settings for drivers are applied after the correct watchdog service.

In case LIN, WU pin and Timer1/2 wakeup sources are disabled while the Standby or Sleep mode is entered through a SPI request, LIN and WU wakeup is automatically enabled (SPI bits “WU_LIN_DIS” and “WU_DIS” are ignored).

SPI wakeup flags have to be cleared before transition to the Standby or Sleep mode is requested, otherwise immediate wakeup occurs.

Table 6. WAKEUP EVENTS

Device Mode	Wakeup Event	SPI Default	SPI Control	SPI Flag	NRES Pulse	INTN Pulse
Standby	SPI	N/A	Cannot be Disabled	N/A	No	No
	I(VR1) > Icmp	Enabled	ICMP_STBY	N/A		Yes
	Bus Wakeup (LIN)	Enabled	WU_LIN_DIS	STATUS_0.WU_LIN		Yes
	WU Change	Enabled	WU_DIS	STATUS_0.WU_WU		Yes
	Timer1/2 Wakeup	Disabled	WU_TIM_EN[1:0]	STATUS_0.WU_TIM		Yes
	TSD1	Disabled	WU_TSD	STATUS_1.TSD1		Yes
	VS_OUT OV/UV	Disabled	WU_OVUV	STATUS_1.VS_OUT_OV, STATUS_1.VS_OUT_UV		Yes
	OUT1-3 Overcurrent	Disabled	WU_OC	STATUS_2.OUTx_OC		Yes
Sleep	Bus Wakeup (LIN)	Enabled	WU_LIN_DIS	STATUS_0.WU_LIN	Yes	No
	WU Change	Enabled	WU_DIS	STATUS_0.WU_WU		
	Timer1/2 Wakeup	Disabled	WU_TIM_EN[1:0]	STATUS_0.WU_TIM		
	TSD1	Disabled	WU_TSD	STATUS_1.TSD1		
	VS_OUT OV/UV	Disabled	WU_OVUV	STATUS_1.VS_OUT_OV, STATUS_1.VS_OUT_UV		
	OUT1-3 Overcurrent	Disabled	WU_OC	STATUS_2.OUTx_OC		
Fail-safe	Bus Wakeup (LIN)	Enabled	Cannot be Disabled (settings ignored)	STATUS_0.WU_LIN	Yes	No
	WU Change	Enabled		STATUS_0.WU_WU		
	Timer1/2 Wakeup	Disabled		STATUS_0.WU_TIM		

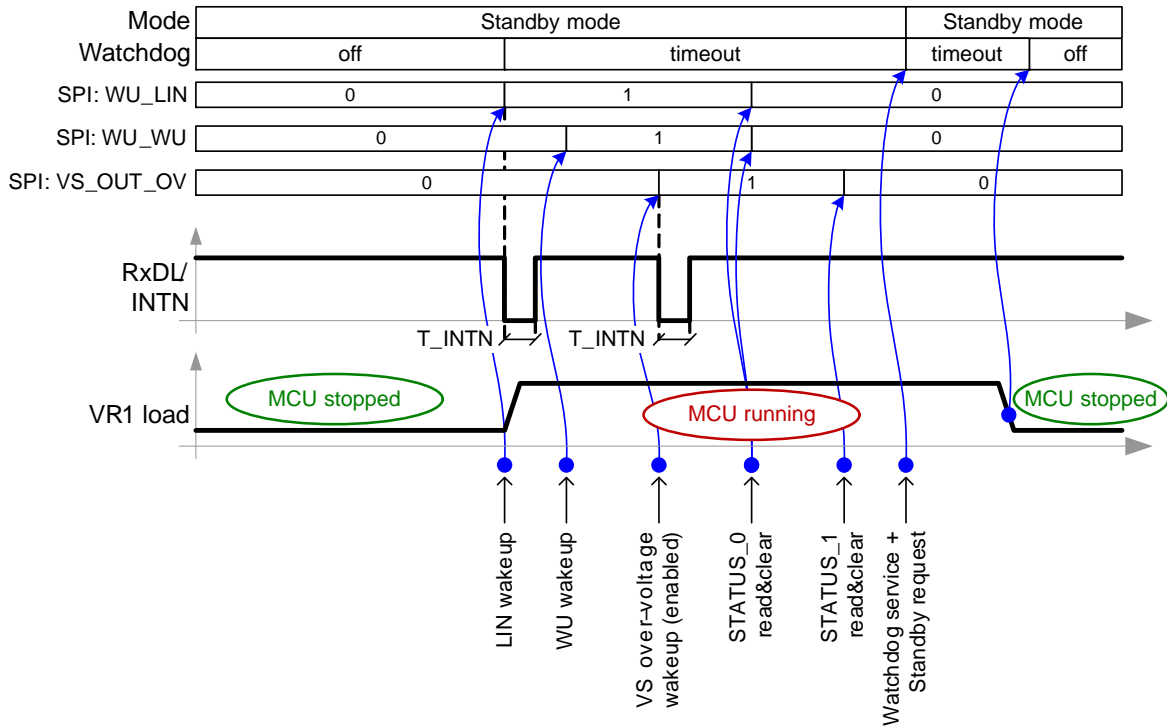

Figure 14. Interrupt Generation, VR1 Current Comparator Enabled

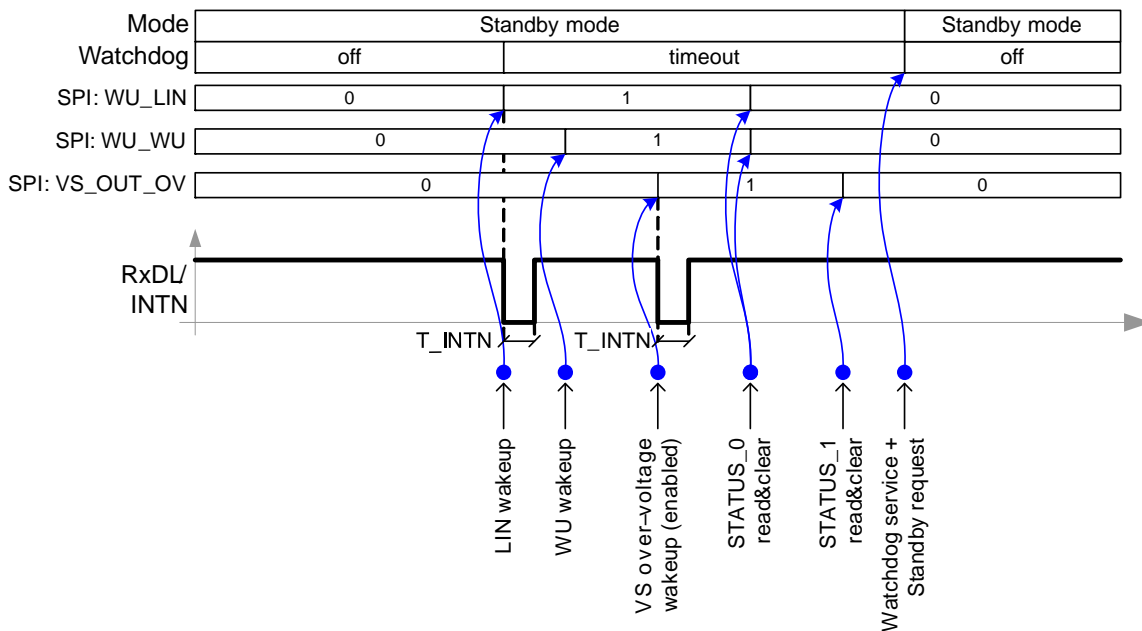

Figure 15. Interrupt Generation, VR1 Current Comparator Disabled

WATCHDOG

The on-chip watchdog requires that the MCU software sends specific SPI messages (watchdog “triggers” or “services”) in a specified time frame. A correct watchdog trigger/service consists of a write access to SPI register CONTROL_0 with “WD_TRIG” bit inverted compared to its previous state. The watchdog timer re-starts immediately after a successful trigger is received.

A read access to the CONTROL_0 register or a write access with “WD_TRIG” bit unchanged does not trigger the watchdog. The moment of the watchdog trigger corresponds to the rising edge of the CSN signal (end of the SPI frame).

The watchdog can work in the following modes (see Figure 4 and Figure 16):

- **Off**: the watchdog is always off in the Sleep and Software development modes. It is also off in the Standby mode, provided that the VR1 consumption stays below the *Icmp_VR1_rise* limit, or when the *Icmp* comparator is disabled.
- **Timeout**: the watchdog works as a timeout timer. The MCU software must serve the watchdog any time before the time-out expiration. Timeout watchdog is started after reset events (power-up, watchdog failure, VR1 under-voltage, thermal shutdown 2), by any wakeup event from both Standby and Sleep mode and in Flash mode. After NRES event, the timeout is typ. 65 ms, while in the Flash mode the timeout may be selected via SPI. The timeout watchdog is started regardless if the wakeup is or is not accompanied by a reset. Watchdog counter position is reflected in SPI status bits “WD_STATUS[1:0]”.

- **Window**: the watchdog time is split to two distinct parts – a closed window, where the watchdog may not be triggered, is followed by an open window where the MCU must send a valid watchdog trigger. Window watchdog is used during the Normal operating mode of the device after the initial timeout watchdog is correctly triggered. Position of the watchdog counter inside the open window is reflected in SPI status bits “WD_STATUS[1:0]”.
- **Failure**: If the watchdog is not triggered correctly (trigger not sent during timeout or open window; or sent during the closed window), reset is generated on pin NRES and the “WD_TRIG” bit is reset to “0”. After the NRES release, the watchdog always starts in the timeout mode. Watchdog failures are counted and their number can be read from the SPI status registers (bits “WD_CNT[3:0]”). After eight watchdog failures in sequence, the VR1 regulator is switched off for 200 ms. In case of seven more watchdog failures, VR1 is completely turned off and the device goes into Fail-safe mode until a wake-up occurs (e.g. via the LIN bus). Second successful watchdog trigger (first in window mode) resets the failure counter. Watchdog failure handling is shown in Figure 17 and Figure 18.

The watchdog time for window mode is selectable from four different values by SPI bits “WD_PER[1:0]”. The watchdog time setting is applied only if it’s contained in an SPI frame representing a correct watchdog trigger message. The setting is ignored otherwise.

NCV7429

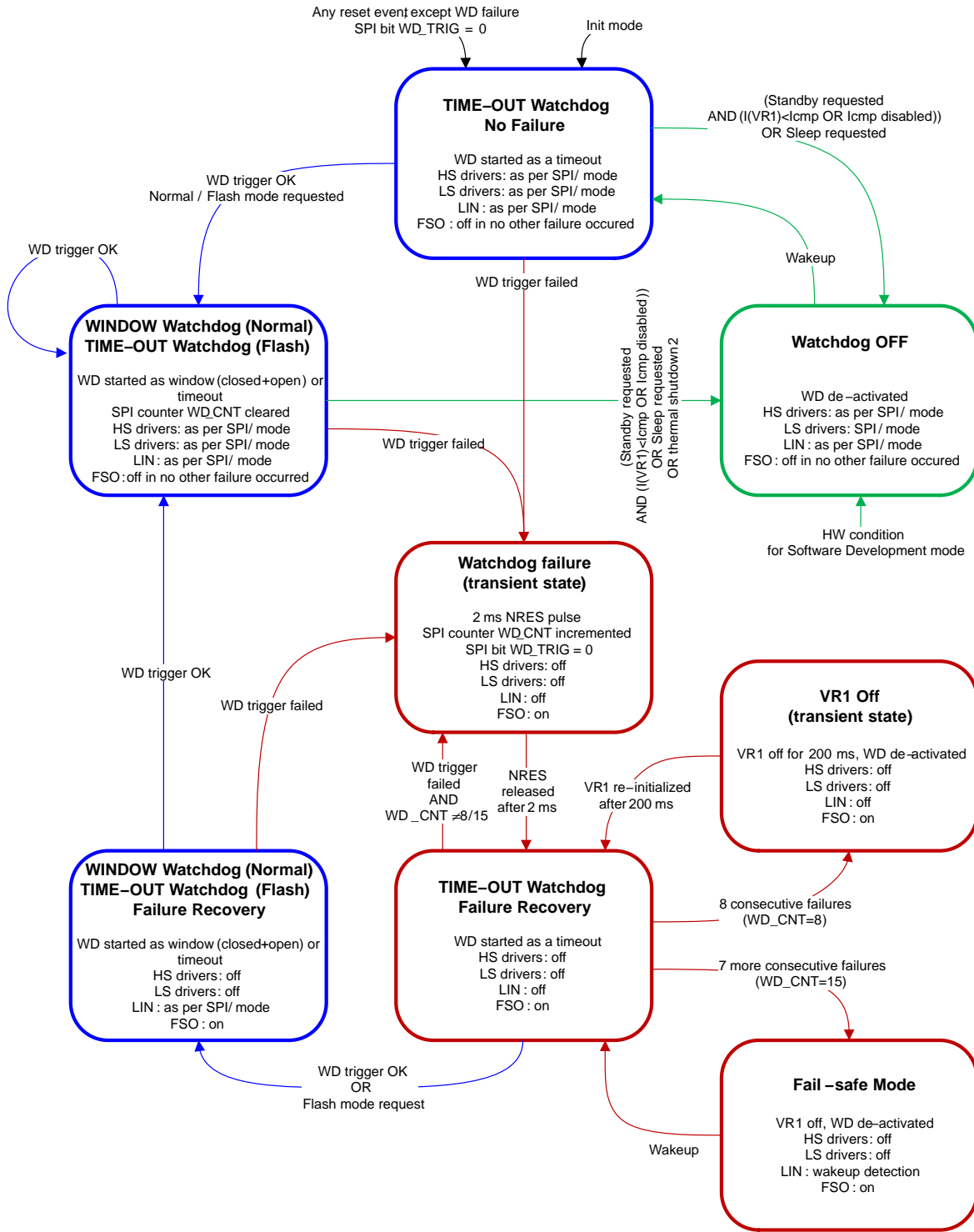

Figure 16. Watchdog Operation

NCV7429

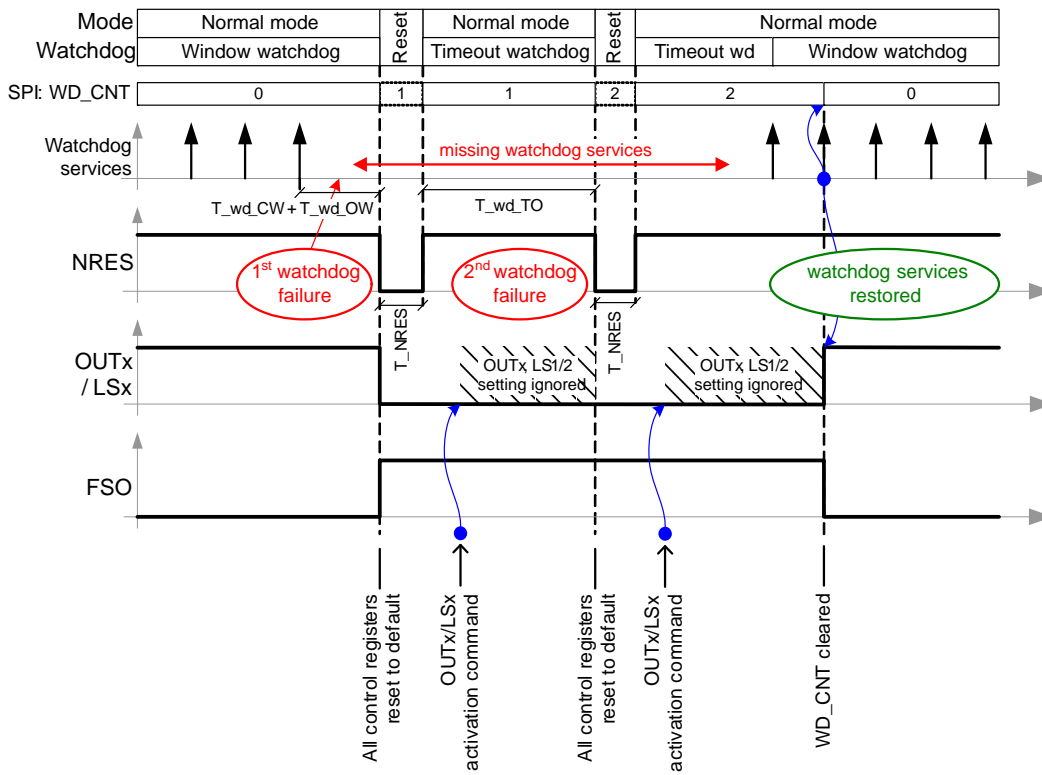

Figure 17. Watchdog Failure – Isolated Events

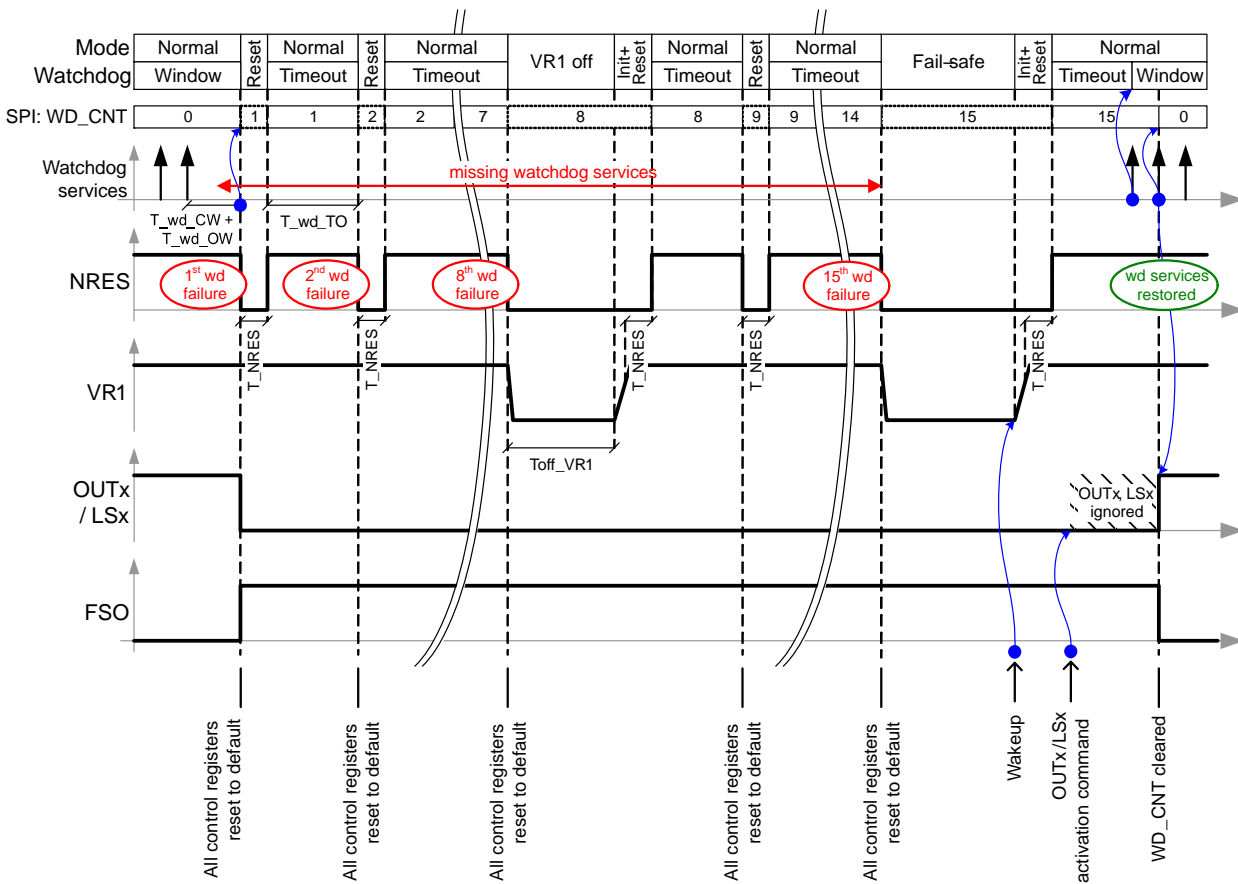

Figure 18. Watchdog Failure – Multiple Events

PROTECTION

Thermal Protection

The device junction temperature is monitored in order to avoid permanent degradation or damage. Three distinct junction temperature levels are provided – thermal warning level T_{jw} (typ. 135°C), thermal shutdown level 1 $T_{j\text{sd}1}$ (typ. 145°C) and thermal shutdown level 2 $T_{j\text{sd}2}$ (typ. 155°C). The thermal protection circuit is always active in the Normal and Standby mode. It is also active in the Sleep mode if any of the high-side outputs is active.

When the junction temperature exceeds the warning level, the event is only latched into the SPI for subsequent diagnostics without any direct effect on the device configuration. When the first thermal shutdown level is exceeded, the most power-consuming functions are disabled (high- and low- side drivers) while VR1 keeps running so

that the MCU can still take appropriate actions. Junction temperature above the second shutdown level leads to complete device de-activation, VR1 included and SPI counter $\text{TSD_CNT}[2:0]$ is incremented. VR1 is re-started after a waiting time of 1 second in case the junction temperature drops below the second shutdown level. If the thermal shutdown then re-occurs seven more times, the device is forced into the Fail-safe mode. $\text{TSD_CNT}[2:0]$ is decremented by one after each one minute without thermal shutdown 2 event.

“TSD1” SPI flag has to be cleared to re-activate the high- and low- side drivers. In the Standby and Sleep mode, the interrupt request is generated to inform the microcontroller about the thermal shutdown 1 event.

The details of the thermal protection handling are shown in Figure 19, Figure 20 and Figure 21.

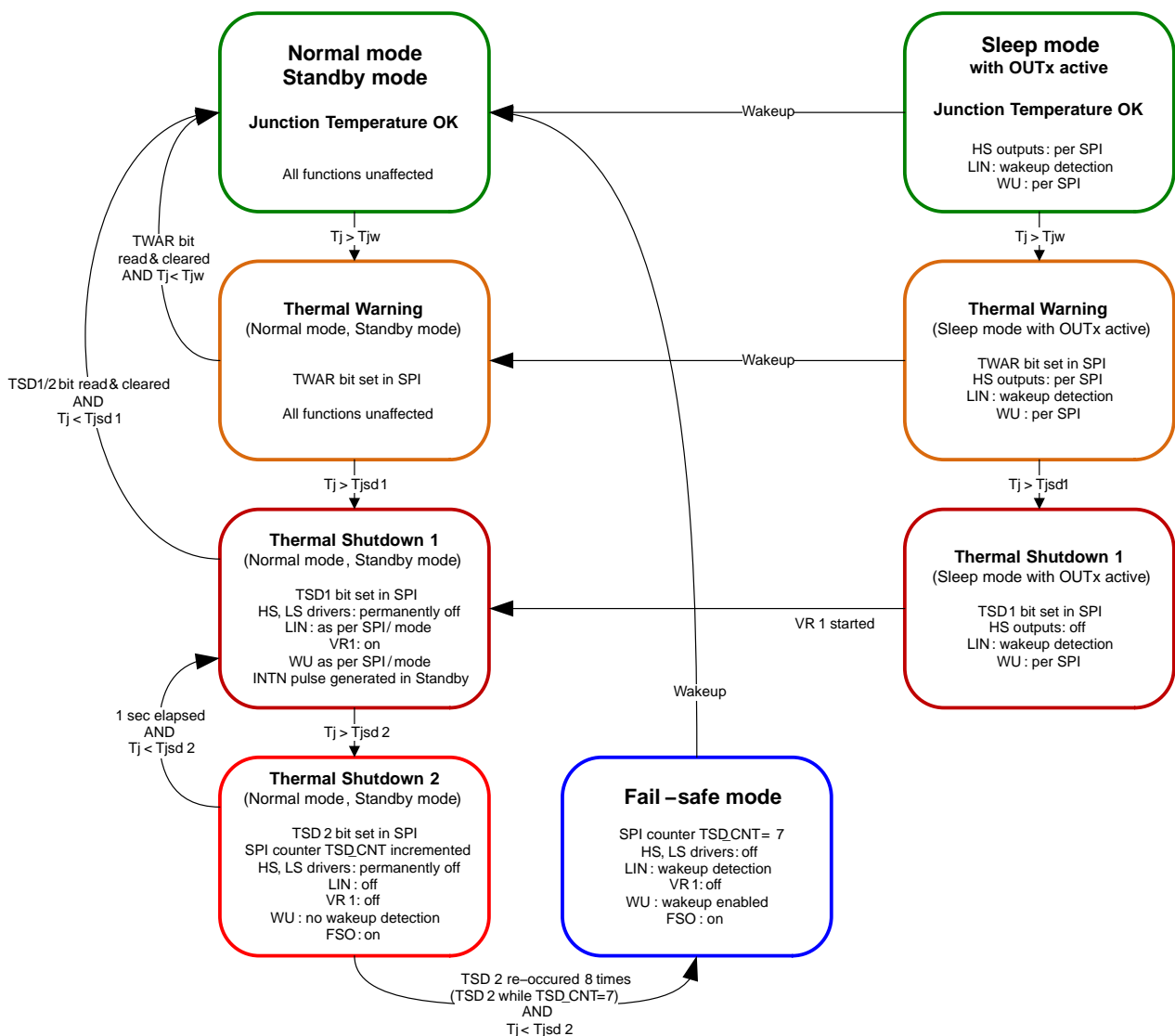

Figure 19. Thermal Protection

VS_OUT Over- and Under-Voltage

In order to protect the loads connected to the high- and low- side drivers, the VS_OUT (car battery) supply is compared against two levels – under-voltage level *VS_OUT_UV* (typ. 5.5 V) and *VS_OUT_OV* (typ. 21 V). The VS_OUT monitoring circuitry is active in Normal mode as well as in the Standby and Sleep modes.

Whenever VS_OUT falls below the *VS_OUT_UV* level or raises above *VS_OUT_OV* level, all high-side drivers are disabled. The under/over-voltage event is latched in the corresponding SPI status bit and if SPI bit “WU_OVUV” is set, the wakeup request is generated in Standby or Sleep mode.

If the SPI control bit “LS_OVUV” is low, the same action is taken for the low-side drivers. After the VS_OUT under/over-voltage condition disappears, it remains flagged in the SPI status. If the SPI control bit “VS_LOCK_DIS” is low, the drivers will remain deactivated until the corresponding flag is not read and cleared. If “VS_LOCK_DIS” is high, the drivers will return to their state defined by SPI registers settings. The details of the VS_OUT monitoring are shown in Figure 22.

SPI control bit “VS_LOCK_DIS” is ignored by OUT3 driver in case it is controlled by FSO signal. OUT3 will return to the previous state immediately after VS_OUT under/over-voltage disappears.

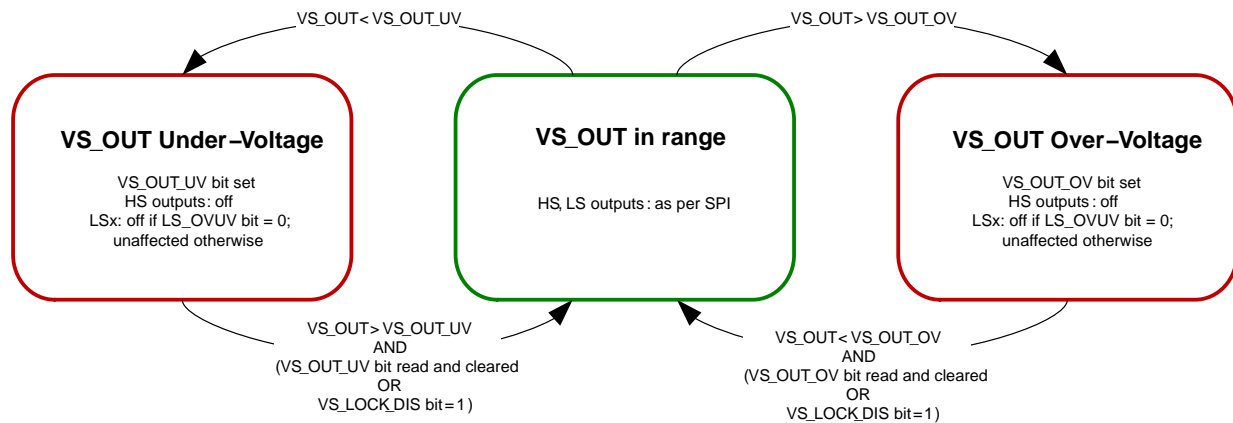

Figure 22. Under- and Over-voltage on VS_OUT Supply

RESET SIGNAL NRES

NRES is an open-drain output with an internal pull-up resistor connected to VR1. It signals reset to the MCU as a consequence of several specific events:

- VR1 under-voltage (including VS power-up)
- Watchdog failure
- Thermal shutdown 2
- Sleep mode
- Wakeup from Sleep mode (the wakeup is accompanied by reset – see Table 6; SPI control registers are not cleared)
- Fail-safe mode

The low-level pulse on NRES pins always extends *T_NRES* (typ. 2 ms) beyond the reset event – e.g. a watchdog failure causes a 2 ms NRES low pulse; a VR1 under-voltage causes NRES pulse extending 2 ms beyond the under-voltage disappearance.

After NRES pulse caused by failure (not after wakeup from Sleep mode), all outputs (OUT1–3, LS1/2) are inactive and CONTROL SPI registers are cleared, except “FSO_DIS” bit. After a wakeup from the Sleep mode, registers content is preserved.

Both LIN transmission and reception is blocked during NRES pulse. A recessive-to-dominant edge on TxDL pin after NRES pulse is required to start transmission to the LIN bus.

INTERRUPT SIGNAL

An interrupt request is used in the Standby mode to indicate some of the wakeup events to the MCU – see section “Wake-up Events”. Interrupt is signaled through RxDL pin by pulling it Low for typically 125 μs. Beside the 125 μs Low pulse, RxDL/INTN remains High throughout the Standby mode.

During Normal mode, RxDL/INTN assumes its normal function (LIN received data).

FAIL-SAFE (FSO) SIGNAL

A fail-safe signal is internally generated reflecting some critical system failures and events. By default, the signal is connected to the OUT3 output and over-rides the OUT3 SPI settings – active FSO signal switches OUT3 on, inactive FSO signal switches OUT3 off. In case the SPI bit “FSO_DIS” is set, OUT3 acts as a general-purpose high-side driver identically to OUT1 and OUT2. FSO remains then only an internal signal not visible to the application. SPI bit “FSO_DIS” is not cleared during any reset event.

FSO internal signal is active after the following events:

- During the Init phase:
 - ♦ VR1 short: FSO is active when VR1 is below its failure level (*Vfail_VR1*) for more than *Tshort_VR1* (typ. 40 ms) during VR1 regulator startup.

- In the Normal and Standby modes:
 - ◆ VR1 under-voltage: FSO is active when VR1 is below its failure level (V_{fail_VR1}). It is deactivated only when VR1_FAIL status bit is cleared.
 - ◆ Watchdog: FSO is immediately activated in case of failed watchdog trigger. It is deactivated only when the watchdog is correctly triggered again for two times.
- ◆ Thermal shutdown: FSO is active when the junction temperature is above the second shutdown threshold (T_{jSD2}). It is deactivated only when TSD2 status bit is cleared.
- In the Fail-safe mode: FSO is always active. FSO is deactivated only when corresponding SPI flag is cleared.

SPI CONTROL

Serial Peripheral Interface (SPI) is the main communication channel between the application MCU and NCV7429. The structure of a SPI frame is shown in Figure 23. MCU starts the frame by sending an 8-bit header consisting of two bits of register access mode type followed by a six-bit address. During the header transmission, NCV7429 sends out eight bits of status information regardless the address. After the header, sixteen bits of data are exchanged. A correct SPI frame has either no bits (no SCLK edges during CSN low; serves to read out the global status information) or exactly twenty-four bits. If another amount of clock edges occurs during CSN low, the frame is considered incorrect and the input data are always ignored.

Depending on the access type, the transmitted/received data are treated differently:

- During a write access, SDO signals current content of the register while new data for the same register are received on SDI. The register is refreshed with the new

data after a successful completion of the frame (rising edge on CSN). Only the bits eligible for write access are refreshed, the input data are ignored for the others (e.g. a write access to status registers).

- For read access, the data on SDI are ignored; SDO signals data content of the register addressed by the header. After the frame completion, the register content remains unchanged regardless the type of the individual bits.
- For read & clear access, a normal register read is performed. When the frame is completed (CSN rising edge), the register bits eligible for read & clear access are reset to 0.
- Device ROM access switches the address space to sixteen-bit constant data memorized in the NCV7429 (indicating the device version, SPI frame format and other information). Input data are ignored.

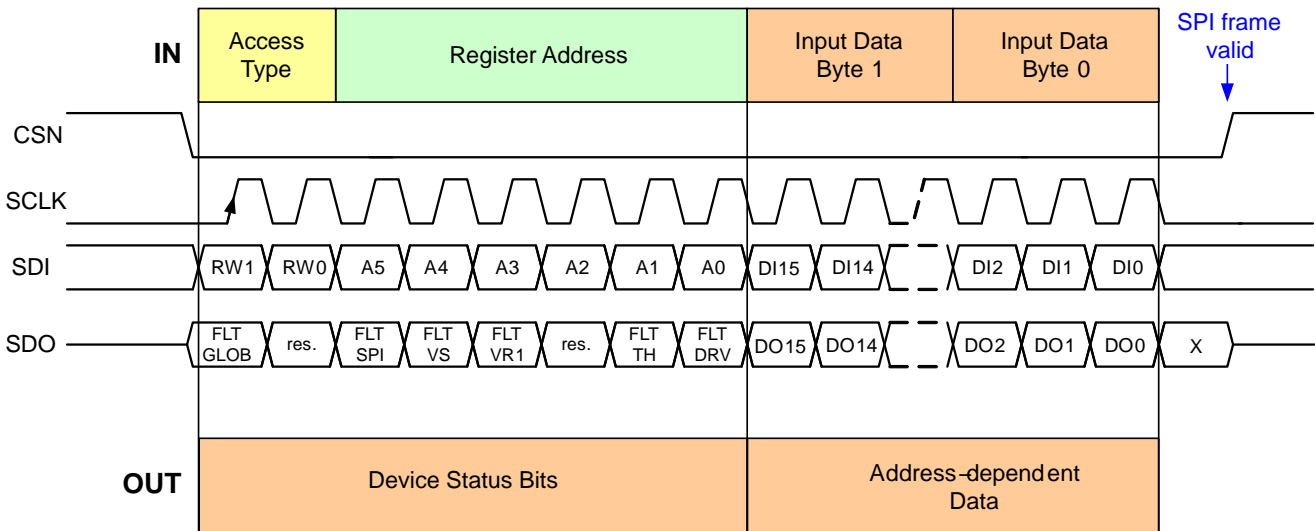

Figure 23. SPI Frame Structure

NCV7429

SPI FRAME FORMAT

	D23	D22	D21	D20	D19	D18	D17	D16	D15	...	D0
NCV7429 IN	RW1	RW0	A5	A4	A3	A2	A1	A0	DI15	...	DI0
NCV7429 OUT	FLT_GLOB	Reserved	FLT_SPI	FLT_VS	FLT_VR1	Reserved	FLT_TH	FLT_DRV	DO15	...	DO0

Inframe:

SPI Access Type	RW1	RW0	Description
	0	0	Write to SPI Register
	0	1	Read Only from SPI Register
	1	0	Read & Clear SPI Register
	1	1	Access Device ROM

SPI Registers	A5	A4	A3	A2	A1	A0	Register	SPI Access
	0	0	0	0	0	0	CONTROL_0	Write, Read
	0	0	0	0	0	1	CONTROL_1	Write, Read
	0	0	0	0	1	0	CONTROL_2	Write, Read
	0	0	0	0	1	1	CONTROL_3	Write, Read
	0	0	0	1	0	0	CONTROL_4	Write, Read
	0	0	0	1	0	1	Reserved	
	0	0	0	1	1	0	PWM_OUT1/2	Write, Read
	0	0	0	1	1	1	PWM_OUT3	Write, Read
	0	0	1	0	0	0	PWM_LS	Write, Read
	0	0	1	0	0	1	STATUS_0	Read, Read & Clear
	0	0	1	0	1	0	STATUS_1	Read, Read & Clear
	0	0	1	0	1	1	STATUS_2	Read, Read & Clear
	0	0	1	1	X	X	Reserved	
	0	1	X	X	X	X	Reserved	
1	X	X	X	X	X	X	Reserved	

Device ROM	A5	A4	A3	A2	A1	A0	Data Content	Comment
	0	0	0	0	0	0	\$4300	ID_HEADER
	0	0	0	0	0	1	\$0203	PRODUCT VERSION
	0	0	0	0	1	0	\$7400	PRODUCT CODE 1
	0	0	0	0	1	1	\$2900	PRODUCT CODE 2
	0	0	0	1	0	0	Reserved	
	Reserved	
	1	1	1	1	0	1	Reserved	
	1	1	1	1	1	0	\$0200	SPI_FRAME_ID
1	1	1	1	1	1	Reserved		

Outframe:

General Device Status Info	SDO Bit	Bit Name	Bit Content
	D23	FLT_GLOB	Logical combination (OR) of all following flags
	D22	Reserved	0
	D21	FLT_SPI	Previous SPI frame faulty – wrong number of clocks or addressing a nonexistent address
	D20	FLT_VS	VS_OV OR VS_UV
	D19	FLT_VR1	Equal to VR1_FAIL bit
	D18	Reserved	0
	D17	FLT_TH	TSD2 OR TSD1 OR TWAR
D16	FLT_DRV	OR combination of all overcurrent and underload bits of OUTx and LSx	

NCV7429

SPI REGISTER DETAILS

CONTROL_0 REGISTER

Address: 00h

Access: Write, Read

Bit	D15	D14	D13	D12	D11	D10	D9	D8	D7	D6	D5	D4	D3	D2	D1	D0
Access Type	RW	RW	RW	RW	RW	RW	–	–	RW	RW	–	–	RW	RW	RW	RW
Bit Name	MODE.1	MODE.0	WD TRIG	WD PER.1	WD PER.0	ICMP STBY	Res.	Res.	VR1 RES.1	VR1 RES.0	Res.	Res.	LIN SLOPE	TXDL TO.1	TXDL TO.0	FSO DIS
Reset Value	0	0	0	0	0	0	0	0	0	0	0	0	0	0	0	x

Mode Control	MODE.1	MODE.0	Operating Mode Request
	0	0	Normal mode (window watchdog)
	0	1	Go to Sleep mode
	1	0	Go to Standby mode
	1	1	Flash mode (time-out watchdog); preceding SPI command has to set FLASH_RDY bit in CONTROL_2, otherwise mode is not changed

Watchdog Trigger Bit	WD_TRIG	Watchdog Trigger Bit
	0	Watchdog trigger set to 0; default state after wakeup from Sleep
	1	Watchdog trigger set to 1

Watchdog Trigger Time	WD_PER.1	WD_PER.0	Configuration of the Watchdog Trigger Time
	0	0	Trigger time = 9.75 ms (Normal mode) / Timeout = 16 ms (Flash mode)
	0	1	Trigger time = 39 ms (Normal mode) / Timeout = 64 ms (Flash mode)
	1	0	Trigger time = 97.5 ms (Normal mode) / Timeout = 160 ms (Flash mode)
	1	1	Trigger time = 195 ms (Normal mode) / Timeout = 640 ms (Flash mode)

Standby VR1 Comparator	ICMP_STBY	Disables the VR1 Current Comparator
	0	Comparator is Enabled in Standby mode
	1	Comparator is Disabled

VR1 Reset Level	VR1_RES.1	VR1_RES.0	Adjustment of the VR1 Reset Level
	0	0	Set the reset threshold to typ. 4.5 V (91%)
	0	1	Set the reset threshold to typ. 4.3 V (87%)
	1	0	Set the reset threshold to typ. 3.9 V (79%)
	1	1	Set the reset threshold to typ. 3.7 V (74%)

LIN Slope Control	LIN_SLOPE	Change of the LIN Slope
	0	High slew rate (as per LIN specification)
	1	Low slew rate

TxDL Time-out Timer	TxDL_TO.1	TxDL_TO.0	Dominant TxD Time-out Configuration of the LIN Interface
	0	0	Set the timer to typ. 55 ms
	0	1	Set the timer to typ. 13 ms
	1	0	Time-out timer disabled
	1	1	Time-out timer disabled

FSO Function Disable	FSO_DIS	OUT3/FSO Function
	0	OUT3 pin is driven by internal FSO signal
	1	OUT3 pins is a general-purpose high-side driver, setting not cleared during Reset

NCV7429

CONTROL_1 REGISTER

Address: 01h

Access: Write, Read

Bit	D15	D14	D13	D12	D11	D10	D9	D8	D7	D6	D5	D4	D3	D2	D1	D0
Access Type	–	RW	RW	RW	–	–	RW	–	–	RW	–	–	–	–	RW	RW
Bit Name	Res.	WU LIN DIS	WU TIM EN.1	WU TIM EN.0	Res.	Res.	WU DIS	Res.	Res.	WU PUD	Res.	Res.	Res.	Res.	WU T.1	WU T.0
Reset Value	0	0	0	0	0	0	0	0	0	0	0	0	0	0	0	0

LIN Wakeup Disable	WU_LIN_DIS		Disables LIN Wakeup in Standby or Sleep Mode
	0		LIN Wakeup Enabled
	1		LIN Wakeup Disabled

WU Input Wakeup Disable	WU_DIS		Disables WU Input Wakeup in Standby or Sleep Mode
	0		WU Input Wakeup Enabled
	1		WU Input Wakeup Disabled

WU Input Sink/Source	WU_PUD		WU Input Sink/Source Current Configuration
	0		WU configured as current sink in all modes, if WU wakeup is enabled
	1		WU configured as current source in all modes, if WU wakeup is enabled

Timer Wakeup Control	WU_TIM_EN.[1:0]		Enables Cyclic (Timer Controlled) Wakeup from Standby or Sleep Mode
	0	0	Timers 1/2 are not used as wakeup sources
	0	1	Wakeup generated based on Timer 1
	1	0	Wakeup generated based on Timer 2
	1	1	Wakeup generated based on Timer 1

WU Input Filter Time	WU_T.[1:0]		Defines the Filter Configuration for Wake Input WU
	0	0	Static sense with 64 μ s filter time (static sense)
	0	1	Timer 2 cyclic sense with sampling start 20 μ s before off-state and 16 μ s filter time
	1	0	Timer 2 cyclic sense with sampling start 20 μ s before off-state and 16 μ s filter time
	1	1	Timer 1 cyclic sense with sampling start 20 μ s before off-state and 16 μ s filter time

NCV7429

CONTROL_2 REGISTER

Address: 02h

Access: Write, Read

Bit	D15	D14	D13	D12	D11	D10	D9	D8	D7	D6	D5	D4	D3	D2	D1	D0
Access Type	RW	RW	–	–	–	–	–	RW	RW	RW	RW	RW	RW	RW	RW	RW
Bit Name	FLASH RDY	SWDM SAMP	Res.	Res.	Res.	Res.	Res.	T2 TPER.2	T2 TPER.1	T2 TPER.0	T2 TON.1	T2 TON.0	T1 TPER.2	T1 TPER.1	T1 TPER.0	T1 TON
Reset Value	0	0	0	0	0	0	0	0	0	0	0	0	0	0	0	0

Flash Ready	FLASH_RDY		Unlocks Flash Mode Entry	
	0		Flash mode request in CONTROL_0 register ignored	
	1		Flash mode may be entered by setting MODE.[1:0] to 11b in following SPI write request. This bit is automatically cleared by any following SPI write command.	

SWDM Pin Sample	SWDM_SAMP		SWDM Pin Sample Request	
	0		SWDM latched value preserved	
	1		SWDM pin sample is requested. New SWDM value will be latched. This bit is automatically cleared when the sampling is finished.	

Timer2 Period	T2_TPER.[2:0]			Defines the Period of the Cyclic Sense Timer2	
	0	0	0	Period: 200 ms	
	0	0	1	Period: 50 ms	
	0	1	0	Period: 20 ms	
	0	1	1	Period: 10 ms	
	1	0	0	Period: 100 ms	
	1	0	1	Period: 150 ms	
	1	1	0	Reserved – if used, will be equal to the default value of 200 ms	
1	1	1	Reserved – if used, will be equal to the default value of 200 ms		

Timer2 On-time	T2_TON.[1:0]		Defines the On Time for the Cyclic Sense Timer2	
	0	0	ON time 100 μ s	
	0	1	ON time 200 μ s	
	1	0	ON time 1 ms	
1	1	ON time 5 ms		

Timer1 Period	T1_TPER.[2:0]			Defines the Period of the Cyclic Sense Timer1	
	0	0	0	Period: 0.5 s	
	0	0	1	Period: 1.0 s	
	0	1	0	Period: 1.5 s	
	0	1	1	Period: 2.0 s	
	1	0	0	Period: 2.5 s	
	1	0	1	Period: 3.0 s	
	1	1	0	Period: 3.5 s	
1	1	1	Period: 4.0 s		

Timer1 On-time	T1_TON		Defines the On Time for the Cyclic Sense Timer1	
	0		ON time 10 ms	
1		ON time 20 ms		

NCV7429

CONTROL_3 REGISTER

Address: 03h

Access: Write, Read

Bit	D15	D14	D13	D12	D11	D10	D9	D8	D7	D6	D5	D4	D3	D2	D1	D0
Access Type	RW	RW	RW	-	-	-	-	-	RW	RW	RW	RW	RW	RW	-	-
Bit Name	WU TSD	WU OC	WU OVUV	Res.	Res.	Res.	Res.	Res.	VS LOCK DIS	LS OVUV	LS2 ON.1	LS2 ON.0	LS1 ON.1	LS1 ON.0	Res.	Res.
Reset Value	0	0	0	0	0	0	0	0	0	0	0	0	0	0	0	0

Thermal Shutdown 1 Wakeup	WU_TSD	Enables Thermal Shutdown 1 Wakeup
	0	TSD1 wakeup disabled
	1	TSD1 wakeup enabled in Standby/Sleep mode

OUT1-3 Overcurrent Wakeup	WU_OC	Enables OUT1-3 Overcurrent Wakeup
	0	OUT1-3 overcurrent wakeup disabled
	1	OUT1-3 overcurrent wakeup enabled in Standby/Sleep mode

VS_OUT OV/UV Wakeup	WU_OVUV	Enables VS_OUT Over-/Under-voltage Wakeup
	0	VS_OUT OV/UV wakeup disabled
	1	VS_OUT OV/UV wakeup enabled in Standby/Sleep mode

VS_OUT UV/OV Lockout	VS_LOCK_DIS	Disables the Automatic VS_OUT Lockout
	0	Outputs will be reactivated only when the VS_OUT UV/OV flag is cleared
	1	Outputs will be reactivated when VS_OUT UV/OV condition disappears

LS1/2 Active in VS_OUT UV/OV	LS_OVUV	Enables LSx in Case of VS_OUT OV/UV
	0	Disabled – LSx will be disabled in case of VS_OUT UV/OV
	1	Enabled – LSx will remain in their previous state in case of VS_OUT UV/OV

LS1/2 Driver Control	LSx_ON.1	LSx_ON.0	Defines the Configuration of the Low-side LS1/2
	0	0	Driver is off in all modes
	0	1	Driver is on in Normal/Flash mode (off in other modes)
	1	0	Driver is controlled by its PWM setting in Normal/Flash mode (off in other modes)
	1	1	Reserved – if used, LSx will be off in all modes (equal to default)

NCV7429

CONTROL_4 REGISTER

Address: 04h

Access: Write, Read

Bit	D15	D14	D13	D12	D11	D10	D9	D8	D7	D6	D5	D4	D3	D2	D1	D0
Access Type	RW	-	-	-	RW	RW	RW	RW	RW	RW	RW	RW	RW	-	-	-
Bit Name	OUT1 HIGHR	Res.	Res.	Res.	OUT3 ON.2	OUT3 ON.1	OUT3 ON.0	OUT2 ON.2	OUT2 ON.1	OUT2 ON.0	OUT1 ON.2	OUT1 ON.1	OUT1 ON.0	Res.	Res.	Res.
Reset Value	0	0	0	0	0	0	0	0	0	0	0	0	0	0	0	0

OUT1 Switch Strength	OUT1_HIGHR			Enables Weaker Switch on OUT1 Output
	0			"Normal-ohmic" configuration; typ. 5 Ω Ron; parameters equal to OUT2-3
	1			"High-ohmic" configuration; typ. 20 Ω Ron; lower underload threshold and current limitation

OUT1-3 Driver Control	OUTx_ON.[2:0]			Defines the Configuration of the High-side OUT1..3
	0	0	0	Driver is off in all modes
	0	0	1	Driver is on in Normal/ Flash, Standby and Sleep mode
	0	1	0	Driver is cyclic on with the timing of Timer1 in Normal/Flash, Standby and Sleep mode
	0	1	1	Driver is cyclic on with the timing of Timer2 in Normal/Flash, Standby and Sleep mode
	1	0	0	Driver is controlled by the corresponding PWM unit in Normal/Flash, Standby and Sleep mode
	1	0	1	Reserved – if used, the driver is off in all modes (equal to default)
	1	1	0	Reserved – if used, the driver is off in all modes (equal to default)
	1	1	1	Reserved – if used, the driver is off in all modes (equal to default)

NCV7429

PWM_OUT1/2 REGISTER

Address: 06h

Access: Write, Read

Bit	D15	D14	D13	D12	D11	D10	D9	D8	D7	D6	D5	D4	D3	D2	D1	D0
Access Type	RW	RW	RW	RW	RW	RW	RW	RW	RW	RW	RW	RW	RW	RW	RW	RW
Bit Name	FSEL OUT1	PW OUT1.6	PW OUT1.5	PW OUT1.4	PW OUT1.3	PW OUT1.2	PW OUT1.1	PW OUT1.0	FSEL OUT2	PW OUT2.6	PW OUT2.5	PW OUT2.4	PW OUT2.3	PW OUT2.2	PW OUT2.1	PW OUT2.0
Reset Value	0	0	0	0	0	0	0	0	0	0	0	0	0	0	0	0

PWM_OUT3 REGISTER

Address: 07h

Access: Write, Read

Bit	D15	D14	D13	D12	D11	D10	D9	D8	D7	D6	D5	D4	D3	D2	D1	D0
Access type	RW	RW	RW	RW	RW	RW	RW	RW	-	-	-	-	-	-	-	-
Bit Name	FSEL OUT3	PW OUT3.6	PW OUT3.5	PW OUT3.4	PW OUT3.3	PW OUT3.2	PW OUT3.1	PW OUT3.0	Res.	Res.	Res.	Res.	Res.	Res.	Res.	Res.
Reset Value	0	0	0	0	0	0	0	0	0	0	0	0	0	0	0	0

PWM_LS REGISTER

Address: 08h

Access: Write, Read

Bit	D15	D14	D13	D12	D11	D10	D9	D8	D7	D6	D5	D4	D3	D2	D1	D0
Access Type	RW	RW	RW	RW	RW	RW	RW	RW	RW	RW	RW	RW	RW	RW	RW	RW
Bit Name	FSEL LS1	PW LS1.6	PW LS1.5	PW LS1.4	PW LS1.3	PW LS1.2	PW LS1.1	PW LS1.0	FSEL LS2	PW LS2.6	PW LS2.5	PW LS2.4	PW LS2.3	PW LS2.2	PW LS2.1	PW LS2.0
Reset Value	0	0	0	0	0	0	0	0	0	0	0	0	0	0	0	0

PWM Frequency	FSEL_OUTx FSEL_LSx	PWM Frequency Selector
	0	Base frequency of PWM on the corresponding output $f(\text{PWM}) = 150 \text{ Hz}$
	1	Base frequency of PWM on the corresponding output $f(\text{PWM}) = 200 \text{ Hz}$

Output Duty Cycle	PW_OUTx[6:0] PW_LSx[6:0]	Duty Cycle Selector
	\$0 ... \$7F	Corresponding output is active with duty cycle $\text{PW_xxx}[6:0] / 127$

NCV7429

STATUS_0 REGISTER

Address: 09h

Access: Read, Read & Clear

Bit	D15	D14	D13	D12	D11	D10	D9	D8	D7	D6	D5	D4	D3	D2	D1	D0
Access Type	R	R	R	R/RC	R/RC	R	–	–	R/RC	R	R	R	R	R	R	R
Bit Name	OP MOD.1	OP MOD.0	COLD START	WU TIM	WU LIN	SWDM	Res.	Res.	WU WU	WD CNT.3	WD CNT.2	WD CNT.1	WD CNT.0	TSD CNT.2	TSD CNT.1	TSD CNT.0

Operating Mode	OPMOD.1	OPMOD.0	Operating Mode
	0	0	Sleep or Fail-safe – latched; updated after first successful access to the register
	0	1	Standby
	1	0	Normal
	1	1	Flash

Cold Start	COLD_START	Power on Reset Status
	0	Cold start (= VS connection) not occurred
	1	Cold start (= VS connection) occurred; cleared after first successful access of the register

Wake-up Source Recognition	WU_TIM	WU_LIN	Remote Wake-up Source
	0	0	No timer nor LIN wake-up occurred
	X	1	LIN wake-up occurred
	1	X	Timer wake-up occurred

SWDM Status	SWDM	Software Development Mode Status (SWDM Pin)
	0	SWDM low during sampling – Normal watchdog operation
	1	SWDM high during sampling – Software Development mode entered

Wake-up Source Recognition	WU_WU	Local Wake-up Source (WU Pin)
	0	No WU pin wake-up occurred
	1	WU pin wake-up occurred

Watchdog Failure Counter	WD_CNT.[3:0]	Number of Watchdog Failures
	0	No watchdog failure encountered
	\$1 ... \$E	Non-zero number of watchdog failures encountered; cleared by second successful watchdog service
	\$F	Fail-safe mode entered due to 15 watchdog failures; cleared by successful watchdog service

TSD2 VR1 Restart Counter	TSD_CNT.[2:0]	Number of VR1 Restarts after Thermal Shutdown 2
	0	No VR1 restarts encountered
	\$1 ... \$6	Non-zero VR1 restarts encountered; decremented after 1 minute
	\$7	Seven consecutive thermal shutdown 2 events, another TSD2 leads to Fail-safe mode entry; decremented after 1 minute after wakeup if no another TSD2 occurs

NCV7429

STATUS_1 REGISTER

Address: 0Ah

Access: Read, Read & Clear

Bit	D15	D14	D13	D12	D11	D10	D9	D8	D7	D6	D5	D4	D3	D2	D1	D0
Access Type	R/RC	-	-	R	-	-	R/RC	-	-	R/RC	R/RC	R/RC	R/RC	R/RC	R/RC	-
Bit Name	FAIL SAFE	Res.	Res.	WU	Res.	Res.	VR1 FAIL	Res.	Res.	VS OUT OV	VS OUT UV	TSD2	TSD1	TWAR	TO TxDL	Res.

Fail-safe Mode	FAIL_SAFE	Wakeup from Fail-safe Mode
	0	Fail-safe was not entered
	1	Wakeup from Fail-safe mode

Status of WU Input	WU	Status of WU Input in Normal Mode
	0	WU is Low
	1	WU is High

VR1 Failure	VR1_FAIL	Voltage Regulator VR1 Failure
	0	No VR1 failure occurred
	1	VR1 fails for at least 5 μ s (VR1 < 2 V for > 5 μ s) OR (VR1 < 2 V at 40 ms after turn-on)

VS_OUT Overvoltage	VS_OUT_OV	Overvoltage on VS_OUT Pin
	0	VS_OUT has not been above the overvoltage limit
	1	VS_OUT exceeded the overvoltage limit (latched)

VS_OUT Undervoltage	VS_OUT_UV	Undervoltage on VS_OUT Pin
	0	VS_OUT has not been below the undervoltage limit
	1	VS_OUT fell below the undervoltage limit (latched)

Thermal Protection	TSD2	TSD1	TWAR	Thermal Warning/Shutdown
	0	0	0	No thermal limit exceeded
	0	0	1	Thermal warning encountered
	0	1	1	Thermal shutdown 1 encountered
	1	1	1	Thermal shutdown 2 encountered
	Other Combinations			Reserved

Permanent Dominant Protection	TO_TxDL	TxDL Dominant
	0	No LIN transmitter timeout encountered
	1	LIN transmitter timeout encountered

NCV7429

STATUS_2 REGISTER

Address: 0Bh

Access: Read, Read & Clear

Bit	D15	D14	D13	D12	D11	D10	D9	D8	D7	D6	D5	D4	D3	D2	D1	D0
Access Type	–	–	R	R	R/RC	R/RC	–	–	R/RC	R/RC	R/RC	–	–	R/RC	R/RC	R/RC
Bit Name	Res.	Res.	WD STAT.1	WD STAT.0	LS2 OC	LS1 OC	Res.	Res.	OUT3 OC	OUT2 OC	OUT1 OC	Res.	Res.	OUT3 UL	OUT2 UL	OUT1 UL

Watchdog Counter Status	WD_STAT.[1:0]		Watchdog Counter Status
	0	0	Watchdog counter below 33% of acceptable interval (Note 1)
	0	1	Watchdog counter above 33% and below 66% of acceptable interval (Note 1)
	1	0	Reserved – not used
	1	1	Watchdog counter above 66% of acceptable interval (Note 1)

1. Acceptable interval means timeout or open window interval

Driver Overcurrent	LSx_OC OUTx_OC		Overcurrent Status of the Corresponding Output
	0		No overcurrent encountered
	1		Overcurrent encountered

Driver Underload	OUTx_UL		Underload Status of the Corresponding Output
	0		No underload encountered
	1		Underload encountered

MECHANICAL CASE OUTLINE

PACKAGE DIMENSIONS

ON Semiconductor®



SCALE 1:1

TSSOP-20 EP
CASE 948AB-01
ISSUE O

DATE 17 JUN 2008

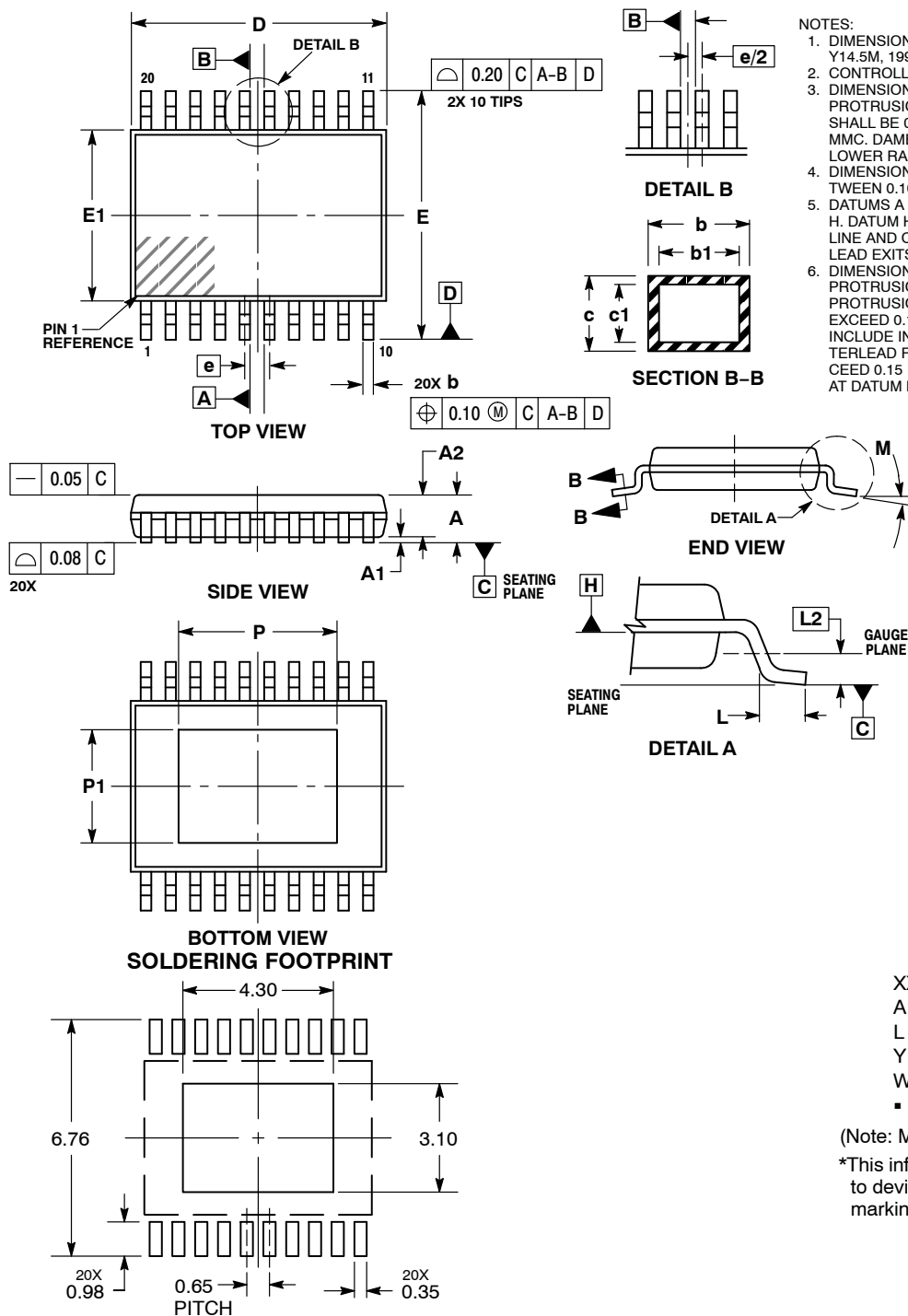

- NOTES:
1. DIMENSIONING AND TOLERANCING PER ASME Y14.5M, 1994.
 2. CONTROLLING DIMENSION: MILLIMETERS.
 3. DIMENSION b DOES NOT INCLUDE DAMBAR PROTRUSION. ALLOWABLE DAMBAR PROTRUSION SHALL BE 0.07 IN EXCESS OF THE LEAD WIDTH AT MMC. DAMBAR CANNOT BE LOCATED ON THE LOWER RADIUS OR THE FOOT OF THE LEAD.
 4. DIMENSIONS b, b1, c, c1 TO BE MEASURED BETWEEN 0.10 AND 0.25 FROM LEAD TIP.
 5. DATUMS A AND B ARE DETERMINED AT DATUM H. DATUM H IS LOCATED AT THE MOLD PARTING LINE AND COINCIDENT WITH LEAD WHERE THE LEAD EXITS THE PLASTIC BODY.
 6. DIMENSION D DOES NOT INCLUDE MOLD FLASH, PROTRUSIONS OR GATE BURRS. MOLD FLASH, PROTRUSIONS OR GATE BURRS SHALL NOT EXCEED 0.15 PER SIDE. DIMENSION E1 DOES NOT INCLUDE INTERLEAD FLASH OR PROTRUSION. INTERLEAD FLASH OR PROTRUSION SHALL NOT EXCEED 0.15 PER SIDE. D AND E1 ARE DETERMINED AT DATUM H.

DIM	MILLIMETERS	
	MIN	MAX
A	---	1.10
A1	0.05	0.15
A2	0.85	0.95
b	0.19	0.30
b1	0.19	0.25
c	0.09	0.20
c1	0.09	0.16
D	6.40	6.60
E	6.40 BSC	
E1	4.30	4.50
e	0.65 BSC	
L	0.50	0.70
L2	0.25 BSC	
M	0°	8°
P	---	4.20
P1	---	3.00

GENERIC MARKING DIAGRAM*

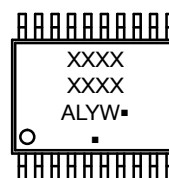

- XXXX = Specific Device Code
- A = Assembly Location
- L = Wafer Lot
- Y = Year
- W = Work Week
- = Pb-Free Package

(Note: Microdot may be in either location)

*This information is generic. Please refer to device data sheet for actual part marking.

DIMENSIONS: MILLIMETERS

DOCUMENT NUMBER:	98AON30874E	Electronic versions are uncontrolled except when accessed directly from the Document Repository. Printed versions are uncontrolled except when stamped "CONTROLLED COPY" in red.
DESCRIPTION:	TSSOP-20 EXPOSED PAD	PAGE 1 OF 1

ON Semiconductor and ON are trademarks of Semiconductor Components Industries, LLC dba ON Semiconductor or its subsidiaries in the United States and/or other countries. ON Semiconductor reserves the right to make changes without further notice to any products herein. ON Semiconductor makes no warranty, representation or guarantee regarding the suitability of its products for any particular purpose, nor does ON Semiconductor assume any liability arising out of the application or use of any product or circuit, and specifically disclaims any and all liability, including without limitation special, consequential or incidental damages. ON Semiconductor does not convey any license under its patent rights nor the rights of others.

onsemi, **Onsemi**, and other names, marks, and brands are registered and/or common law trademarks of Semiconductor Components Industries, LLC dba "**onsemi**" or its affiliates and/or subsidiaries in the United States and/or other countries. **onsemi** owns the rights to a number of patents, trademarks, copyrights, trade secrets, and other intellectual property. A listing of **onsemi**'s product/patent coverage may be accessed at www.onsemi.com/site/pdf/Patent-Marking.pdf. **onsemi** reserves the right to make changes at any time to any products or information herein, without notice. The information herein is provided "as-is" and **onsemi** makes no warranty, representation or guarantee regarding the accuracy of the information, product features, availability, functionality, or suitability of its products for any particular purpose, nor does **onsemi** assume any liability arising out of the application or use of any product or circuit, and specifically disclaims any and all liability, including without limitation special, consequential or incidental damages. Buyer is responsible for its products and applications using **onsemi** products, including compliance with all laws, regulations and safety requirements or standards, regardless of any support or applications information provided by **onsemi**. "Typical" parameters which may be provided in **onsemi** data sheets and/or specifications can and do vary in different applications and actual performance may vary over time. All operating parameters, including "Typicals" must be validated for each customer application by customer's technical experts. **onsemi** does not convey any license under any of its intellectual property rights nor the rights of others. **onsemi** products are not designed, intended, or authorized for use as a critical component in life support systems or any FDA Class 3 medical devices or medical devices with a same or similar classification in a foreign jurisdiction or any devices intended for implantation in the human body. Should Buyer purchase or use **onsemi** products for any such unintended or unauthorized application, Buyer shall indemnify and hold **onsemi** and its officers, employees, subsidiaries, affiliates, and distributors harmless against all claims, costs, damages, and expenses, and reasonable attorney fees arising out of, directly or indirectly, any claim of personal injury or death associated with such unintended or unauthorized use, even if such claim alleges that **onsemi** was negligent regarding the design or manufacture of the part. **onsemi** is an Equal Opportunity/Affirmative Action Employer. This literature is subject to all applicable copyright laws and is not for resale in any manner.

PUBLICATION ORDERING INFORMATION

LITERATURE FULFILLMENT:

Email Requests to: orderlit@onsemi.com

onsemi Website: www.onsemi.com

TECHNICAL SUPPORT

North American Technical Support:

Voice Mail: 1 800-282-9855 Toll Free USA/Canada

Phone: 011 421 33 790 2910

Europe, Middle East and Africa Technical Support:

Phone: 00421 33 790 2910

For additional information, please contact your local Sales Representative