

LIN Transceiver with Voltage Regulator and Reset Pin



ON Semiconductor®

www.onsemi.com

General Description

The NCV7425 is a fully featured local interconnect network (LIN) transceiver designed to interface between a LIN protocol controller and the physical bus.

The NCV7425 LIN device is a member of the in-vehicle networking (IVN) transceiver family of ON Semiconductor that integrates a LIN v2.1 physical transceiver and a low-drop voltage regulator.

The LIN bus is designed to communicate low rate data from control devices such as door locks, mirrors, car seats, and sunroofs at the lowest possible cost. The bus is designed to eliminate as much wiring as possible and is implemented using a single wire in each node. Each node has a slave MCU-state machine that recognizes and translates the instructions specific to that function. The main attraction of the LIN bus is that all the functions are not time critical and usually relate to passenger comfort.

Features

- LIN-Bus Transceiver
 - ◆ LIN compliant to specification revision 2.1 (backward compatible to versions 2.0 and 1.3) and J2602
 - ◆ Bus Voltage ± 45 V
 - ◆ Transmission Rate up to 20 kBaud
 - ◆ Integrated Slope Control for Improved EMI Compatibility
- Package
 - ◆ SOIC-16 Wide Body Package with Exposed Pad
- Protection
 - ◆ Thermal Shutdown
 - ◆ Indefinite Short-Circuit Protection on Pins LIN and WAKE Towards Supply and Ground
 - ◆ Load Dump Protection (45 V)
 - ◆ Bus Pins Protected Against Transients in an Automotive Environment
 - ◆ ESD Protection Level for LIN, INH, WAKE and V_{BB} up to ± 10 kV
- Voltage Regulator
 - ◆ Two Device Versions: Output Voltage 3.3 V or 5 V For Loads up to 150 mA
 - ◆ Undervoltage Detector with a Reset Output to the Supplied Microcontroller
 - ◆ INH Output for Auxiliary Purposes (switching of an external pull-up or resistive divider towards battery, control of an external voltage regulator etc.)

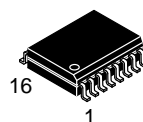

SOIC-16 LEAD
WIDE BODY
EXPOSED PAD
CASE 751AG

MARKING DIAGRAM



x = 0 or 5
A = Assembly Location
WL = Wafer Lot
YY = Year
WW = Work Week
G = Pb-Free Package

ORDERING INFORMATION

See detailed ordering and shipping information in the package dimensions section on page 19 of this data sheet.

- Modes
 - ◆ Normal Mode: LIN Communication in Either Low (up to 10 kBaud) or Normal Slope
 - ◆ Sleep Mode: V_{CC} is Switched “off” and No Communication on LIN Bus
 - ◆ Standby Mode: V_{CC} is Switched “on” but There is No Communication on LIN Bus
 - ◆ Wake-up Bringing the Component From Sleep Mode Into Standby Mode is Possible Either by LIN Command or Digital Input Signal on WAKE Pin Wake-up from LIN Bus can also be Detected and Flagged When the Chip is Already in Standby Mode

Quality

- NCV Prefix for Automotive and Other Applications Requiring Unique Site and Control Change Requirements; AEC-Q100 Qualified and PPAP Capable
- These Devices are Pb-Free, Halogen Free/BFR Free and are RoHS Compliant

Typical Applications

- Automotive
- Industrial Networks

NCV7425

Table 1. KEY TECHNICAL CHARACTERISTICS

Symbol	Parameter	Min	Typ	Max	Unit
3.3 V VERSION					
V _{BB}	Nominal battery operating voltage	5	12	28	V
V _{BB}	Load dump protection (Note 1)			45	V
I _{BB_SLP}	Supply current in sleep mode			20	μA
V _{CC_OUT} (Note 2)	Regulated V _{CC} output in normal mode, V _{CC} load 0–100 mA	3.234	3.3	3.366	V
	Regulated V _{CC} output in normal mode, 100 mA < V _{CC} load < 150 mA	3.201	3.3	3.399	V
I _{OUT_LIM}	V _{CC} regulator current limitation	150	225	300	mA
V _{WAKE}	Operating DC voltage on WAKE pin	0		V _{BB}	V
	Maximum rating voltage on WAKE pin	–45		45	V
V _{INH}	Operating DC voltage on INH pin	0		V _{BB}	V
T _{J_TSD}	Junction thermal shutdown temperature	165		195	°C
T _J	Operating junction temperature	–40		+150	°C

5 V VERSION

V _{BB}	Nominal battery operating voltage	6	12	28	V
V _{BB}	Load dump protection (Note 1)			45	V
I _{BB_SLP}	Supply current in sleep mode			20	μA
V _{CC_OUT} (Note 2)	Regulated V _{CC} output in normal mode, V _{CC} load 0–100 mA	4.90	5	5.10	V
	Regulated V _{CC} output in normal mode, 100 mA < V _{CC} load < 150 mA	4.85	5	5.15	V
I _{OUT_LIM}	V _{CC} regulator current limitation	150	225	300	mA
V _{WAKE}	Operating DC voltage on WAKE pin	0		V _{BB}	V
	Maximum rating voltage on WAKE pin	–45		45	V
V _{INH}	Operating DC voltage on INH pin	0		V _{BB}	V
T _{J_TSD}	Junction thermal shutdown temperature	165		195	°C
T _J	Operating junction temperature	–40		+150	°C

1. The applied transients shall be in accordance with ISO 7637 part 1, test pulse 5. The device complies with functional class C;. The LIN communication itself complies with functional class B. On regulator class A can be reached depending on the application and external components
2. V_{CC} voltage must be properly stabilized by external capacitors: capacitor of min. 80 nF with ESR < 10 mΩ in parallel with a capacitor of min. 8 μF, ESR < 1 Ω.

Table 2. THERMAL CHARACTERISTICS

Symbol	Parameter	Conditions	Value	Unit
R _{th(vj-a)_1}	Thermal resistance junction–to–ambient on JEDEC 1S0P PCB	Free Air	138	K/W
R _{th(vj-a)_2}	Thermal resistance junction–to–ambient on JEDEC 1S0P + 300 mm ² PCB	Free Air	94	K/W
R _{th(vj-a)_3}	Thermal resistance junction–to–ambient on JEDEC 2S2P PCB	Free Air	70	K/W
R _{th(vj-a)_4}	Thermal resistance junction–to–ambient on JEDEC 2S2P + 300 mm ² PCB	Free Air	49	K/W

NCV7425

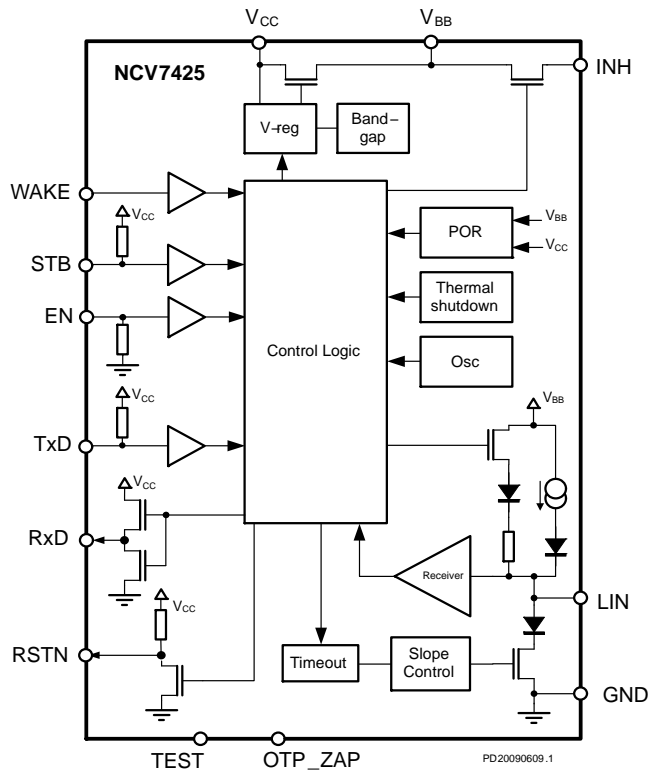

Figure 1. Block Diagram

TYPICAL APPLICATION

Application Information

The EMC immunity of the Master-mode device can be further enhanced by adding a capacitor between the LIN output and ground. The optimum value of this capacitor is determined by the length and capacitance of the LIN bus, the number and capacitance of Slave devices, the pull-up resistance of all devices (Master and Slave), and the required time constant of the system, respectively.

V_{CC} voltage must be properly stabilized by external capacitors: capacitor of min. 80 nF (ESR < 10 mΩ) in parallel with a capacitor of min. 8 μF (ESR < 1 Ω).

The 10 μF capacitor on the battery is optional and serves as reservoir capacitor to deal with battery supply micro-cuts.

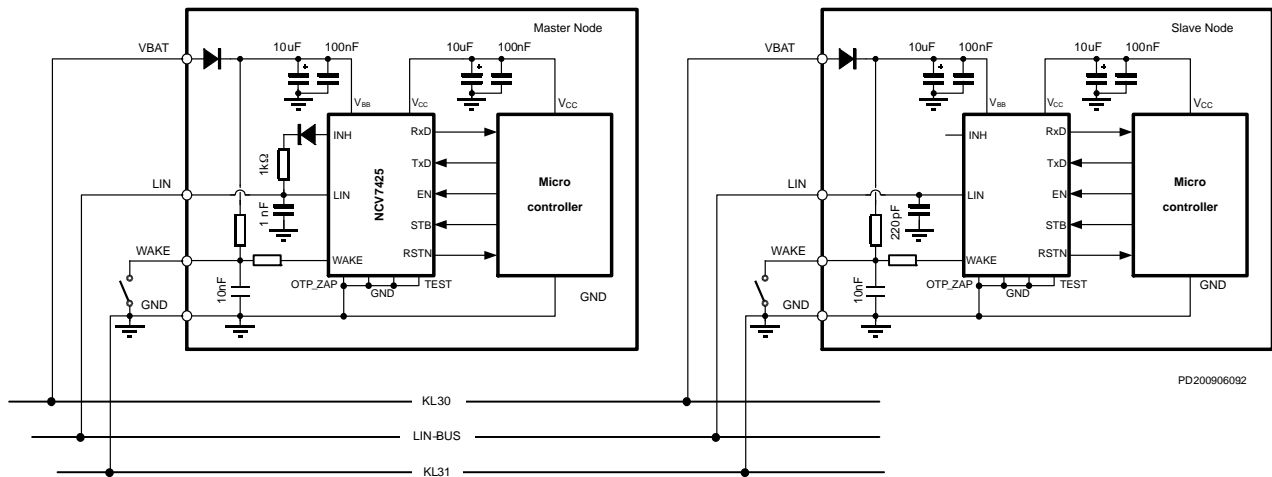

Figure 2. Application Diagram

NCV7425

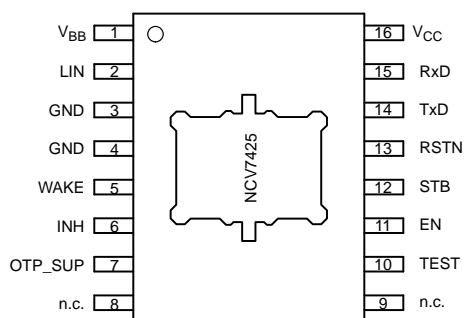

Figure 3. Pin Assignment

Table 3. PIN FUNCTION DESCRIPTION

Pin Number	Pin Name	Description
1	V _{BB}	Battery supply input
2	LIN	LIN bus output/input
3	GND	Ground
4	GND	Ground
5	WAKE	High voltage digital input pin to switch the part from sleep- to standby mode
6	INH	Inhibit output
7	OTP_SUP	Supply for programming of trimming bits at factory testing, needs to be grounded in the application
8	n.c.	not connected
9	n.c.	not connected
10	TEST	Digital input for factory testing, needs to be grounded in the application
11	EN	Enable input for mode control
12	STB	Standby mode control input
13	RSTN	Reset output; open-drain output with an on-chip pull-up resistor
14	TxD	Transmit data input, Low in dominant state
15	RxD	Receive data output; Low in dominant state; push-pull output
16	V _{CC}	Voltage regulator output

FUNCTIONAL DESCRIPTION

Overall Functional Description

LIN is a serial communication protocol that efficiently supports the control of mechatronic nodes in distributed automotive applications. The domain is class-A multiplex buses with a single master node and a set of slave nodes.

NCV7425 is designed as a master or slave node for the LIN communication interface with an integrated 3.3 V or 5 V voltage regulator having a current capability up to 150 mA for supplying any external components (microcontroller, CAN node, etc.).

NCV7425 contains the LIN transmitter, LIN receiver, voltage regulator, power-on-reset (POR) circuits and thermal shutdown (TSD). The LIN transmitter is optimized for the maximum specified transmission speed of 20 kBaud

with EMC performance due to reduced slew rate of the LIN output.

The junction temperature is monitored via a thermal shutdown circuit that switches the LIN transmitter and voltage regulator off when temperature exceeds the TSD trigger level.

NCV7425 has four operating states (normal mode, low slope mode, standby mode, and sleep mode) that are determined by the input signals EN, WAKE, STB, and TxD.

Operating States

NCV7425 provides four operating states, two modes for normal operation with communication, one standby without communication and one low power mode with very low current consumption – see Figure 4 and Table 4.

Table 4. MODE SELECTION

Mode	V _{CC}	RxD	INH	LIN Transceiver	30 kΩ on LIN	RSTN
Normal – Slope (Note 3)	ON	Low = Dominant State High = Recessive State	High if STB = High during state transition; Floating otherwise	Normal Slope	ON	High
Normal – Low Slope (Note 4)	ON	Low = Dominant State High = Recessive State	High if STB = High during state transition; Floating otherwise	Low Slope	ON	High
Standby (Note 5)	ON	Low after LIN wake-up, High otherwise (Note 6)	Floating	OFF	OFF	Controlled by V _{CC} undervoltage monitor
Sleep	OFF	Clamped to V _{CC} (Note 6)	Floating	OFF	OFF	Low

- The normal slope mode is entered when pin EN goes High while TxD is in High state during EN transition.
- The low slope mode is entered when pin EN goes High while TxD is in Low state during EN transition. LIN transmitter gets on only after TxD returns to High after the state transition.
- The standby mode is entered automatically after power-up.
- In standby and Sleep mode, the High state is achieved by internal pull-up resistor to V_{CC}.

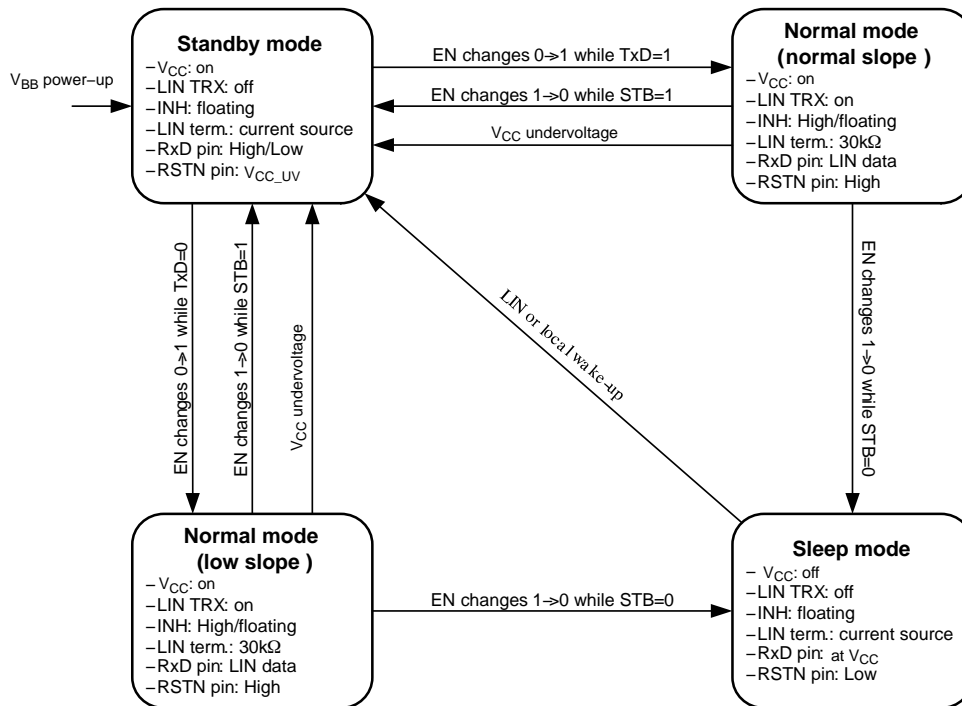

Figure 4. State Diagram

PD20090610.01

Normal Slope Mode

In normal slope mode the transceiver can transmit and receive data via LIN bus with speed up to 20 kBaud. The transmit data stream of the LIN protocol is present on the TxD pin and converted by the transmitter into a LIN bus signal with controlled slew rate to minimize EMC emission. The receiver consists of the comparator that has a threshold with hysteresis in respect to the supply voltage and an input filter to remove bus noise. The LIN output is pulled High via an internal 30 kΩ pull-up resistor. For master applications it is needed to put an external 1 kΩ resistor with a serial diode between LIN and V_{BB} (or INH) – see Figure 2. The

mode selection is done by EN=High when TxD pin is High. If STB pin is High during the standby-to-normal slope mode transition, INH pin is pulled High. Otherwise, it stays floating.

Low Slope Mode

In low slope mode the slew rate of the signal on the LIN bus is reduced (rising and falling edges of the LIN bus signal are longer). This further reduces the EMC emission. As a consequence the maximum speed on the LIN bus is reduced up to 10 kBaud. This mode is suited for applications where the communication speed is not critical. The mode selection

is done by EN=High when TxD pin is Low. In order not to transmit immediately a dominant state on the bus (because TxD = Low), the LIN transmitter is enabled only after TxD returns to High. If STB pin is High during the standby-to-low slope mode transition, INH pin is pulled High. Otherwise, it stays floating.

Standby Mode

The standby mode is always entered after power-up of the NCV7425. It can also be entered from normal mode when the EN pin is Low and the standby pin is High. From sleep mode it can be entered after a local wake-up or LIN wake-up. In standby mode the V_{CC} voltage regulator for supplying external components (e.g. a microcontroller) stays active. Also the LIN receiver stays active to be able to detect a remote wake-up via bus. The LIN transmitter is disabled and the slave internal termination resistor of 30 kΩ between LIN and V_{BB} is disconnected in order to minimize current consumption. Only a pull-up current source between V_{BB} and LIN is active.

Sleep Mode

The Sleep Mode provides extremely low current consumption. This mode is entered when both EN and STB pins are Low coming from normal mode. The internal termination resistor of 30 kΩ between LIN and V_{BB} is disconnected and also the V_{CC} regulator is switched off to minimize current consumption.

Wake-up

NCV7425 has two possibilities to wake-up from sleep or standby mode (see Figure 4):

Local wake-up: enables the transition from sleep mode to standby mode

Remote wake-up via LIN: enables the transition from sleep to standby mode and can be also detected when already in standby mode.

A local wake-up is **only** detected in sleep mode if a transition from Low to High or from High to Low is seen on the WAKE pin.

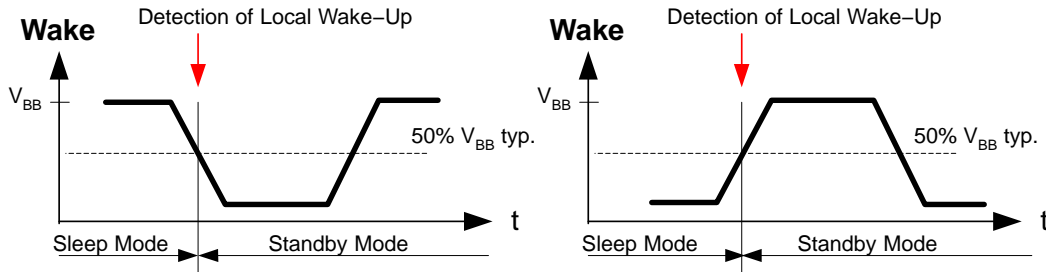

Figure 5. Local Wake-Up Signal

PC20060427.3

A remote wake-up is **only** detected if a combination of (1) a falling edge at the LIN pin (transition from recessive to dominant) is followed by (2) a dominant level maintained

for a time period > t_{WAKE} and (3) again a rising edge at pin LIN (transition from dominant to recessive) happens.

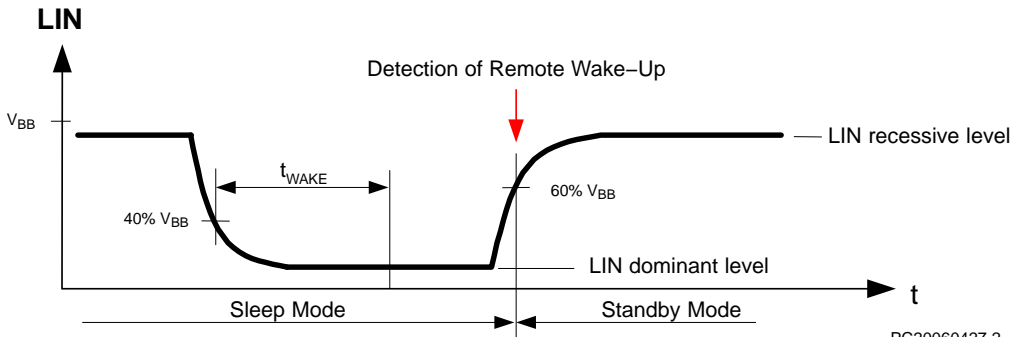

Figure 6. Remote Wake-Up Behavior

PC20060427.2

The wake-up source is distinguished by pin RxD in the standby mode:

RxD remains High after power-up or local wake-up.

RxD is kept Low until normal mode is entered after a remote wake-up (LIN)

V_{CC} Undervoltage Detection and RSTN Pin

In standby, normal and low slope modes, the V_{CC} regulator is monitored. Whenever the regulator output falls below V_{CC_UV_THR} level (typically 90% of the nominal voltage) for longer than V_{CC_UV_deb} (typically 5 μs), an

NCV7425

undervoltage is detected. Output pin RSTN is pulled to Low level to indicate the undervoltage condition to the external load (a microcontroller). At the same time, the device enters automatically the standby mode. As soon as the regulator output returns above the undervoltage level, the RSTN Low level is extended by typically 6ms and only then released to High level in order to ensure microcontroller initialization under correct supply conditions.

In the sleep mode, RSTN pin is kept Low regardless the V_{CC} level – it means that RSTN becomes Low immediately at sleep mode entry even if the V_{CC} capacitor is still charged.

In all situations where RSTN pin is kept Low, the digital inputs to NCV7425 are discarded by the internal control logic and have no effect on its behavior.

The RSTN pin function is illustrated in Figure 7.

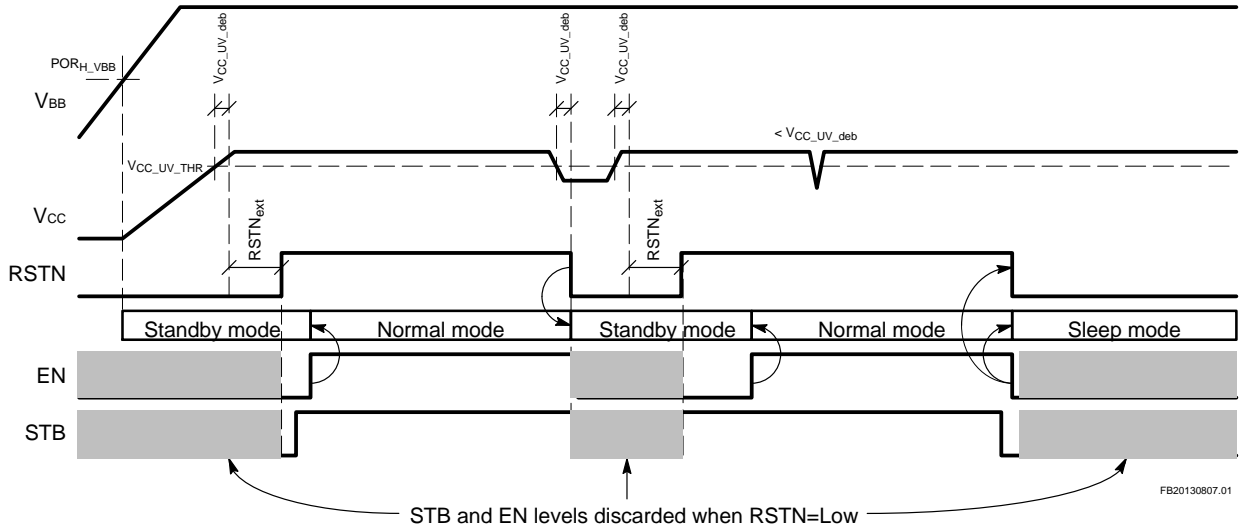

Figure 7. RSTN Pin Behavior

ELECTRICAL CHARACTERISTICS

Definitions

All voltages are referenced to GND. Positive currents flow into the IC.

Table 5. ABSOLUTE MAXIMUM RATINGS – 3.3 V and 5 V VERSIONS

Symbol	Parameter	Min.	Max.	Unit
V _{BB}	Battery voltage on pin V _{BB} (Note 7)	-0.3	+45	V
V _{CC}	DC voltage on pin V _{CC}	0	+6	V
I _{VCC}	Current delivered by the V _{CC} regulator	150		mA
V _{LIN}	LIN bus voltage (Note 8)	-45	+45	V
V _{INH}	DC voltage on inhibit pin	-0.3	V _{BB} + 0.3	V
V _{WAKE}	Voltage on WAKE pin	-45	45	V
V _{Dig_IO}	DC voltage on pins TxD, RxD, EN, STB, RSTN	-0.3	V _{CC} + 0.3	V
T _J	Maximum junction temperature	-40	+165	°C
V _{esd}	Electrostatic discharge voltage (INH, WAKE and V _{BB}) system Human Body Model (HBM) (Note 9)	-10	+10	kV
	Electrostatic discharge voltage (LIN pin, no external capacitor) HBM (Note 9)	-10	+10	
	Electrostatic discharge voltage (LIN pin, 220 pF) System HBM (Note 9)	-15	+15	
	Electrostatic discharge voltage (pins LIN, INH, WAKE and V _{BB}) HBM (Note 10)	-8	+8	
	Electrostatic discharge voltage (other pins) HBM (Note 10)	-4	+4	
	Electrostatic discharge voltage; charge device model (Note 11)	-250	+250	V

Stresses exceeding those listed in the Maximum Ratings table may damage the device. If any of these limits are exceeded, device functionality should not be assumed, damage may occur and reliability may be affected.

7. The applied transients shall be in accordance with ISO 7637 part 1, test pulses 1, 2, 3a, 3b, and 5. The device complies with functional class C; class A can be reached depending on the application and external components.
8. The applied transients shall be in accordance with ISO 7637 part 1, test pulses 1, 2, 3a, and 3b. The device complies with functional class C; class A can be reached depending on the application and external components.
9. Equivalent to discharging a 150 pF capacitor through a 330 Ω resistor conform to IEC Standard 61000-4-2. The specified values are verified by external test house.
10. Equivalent to discharging a 100 pF capacitor through a 1.5 kΩ resistor conform to MIL STD 883 method 3015.7.
11. Conform to EOS/ESD-DS5.3 (socket mode).

Table 6. DC CHARACTERISTICS – 3.3 V VERSION

V_{BB} = 5 V to 28 V; T_J = -40°C to +150°C; unless otherwise specified.

Symbol	Parameter	Conditions	Min	Typ	Max	Unit
--------	-----------	------------	-----	-----	-----	------

DC CHARACTERISTICS SUPPLY – PINS V_{BB} AND V_{CC}

I _{BB_ON}	Supply current	Normal mode; LIN recessive			1.6	mA
I _{BB_STB}	Supply current	Standby mode, V _{BB} = 5 – 18 V, T _J < 105°C			60	μA
I _{BB_SLP}	Supply current	Sleep mode, V _{BB} = 5 – 18 V, T _J < 105°C			20	μA

DC CHARACTERISTICS – VOLTAGE REGULATOR

V _{CC_OUT}	Regulator output voltage	V _{CC} load 0 – 100 mA	3.234	3.30	3.366	V
		100 mA < V _{CC} load < 150 mA	3.201	3.30	3.399	
I _{OUT_LIM}	Overcurrent limitation		150	225	300	mA
V _{CC_UV_THR}	Undervoltage detection threshold		2.80	2.97	3.13	V

12. Measured at output voltage V_{CC_OUT} = (V_{CC_OUT} @ V_{BB} = 5 V) – 2%.

13. The voltage drop in Normal mode between LIN and V_{BB} pin is the sum of the diode drop and the drop at serial pull-up resistor. The drop at the switch is negligible. See Figure 2.

14. Guaranteed by design. Not tested

NCV7425

Table 6. DC CHARACTERISTICS – 3.3 V VERSION

$V_{BB} = 5\text{ V to }28\text{ V}$; $T_J = -40^\circ\text{C to }+150^\circ\text{C}$; unless otherwise specified.

Symbol	Parameter	Conditions	Min	Typ	Max	Unit
--------	-----------	------------	-----	-----	-----	------

DC CHARACTERISTICS – VOLTAGE REGULATOR

ΔV_{CC_OUT}	Line Regulation	$V_{BB} = 5 - 28\text{ V}$, $I_{out} = 5\text{ mA}$ $T_J = 25^\circ\text{C}$		0.41		mV
	Load Regulation	$I_{out} = 1 - 100\text{ mA}$, $V_{BB} = 14\text{ V}$, $T_J = 25^\circ\text{C}$		25		
V_{do}	Dropout Voltage ($V_{BB} - V_{CC_OUT}$) (Note 12) Figure 12	$I_{out} = 10\text{ mA}$, $T_J = 25^\circ\text{C}$		22		mV
		$I_{out} = 50\text{ mA}$, $T_J = 25^\circ\text{C}$		108		
		$I_{out} = 100\text{ mA}$, $T_J = 25^\circ\text{C}$		216		

DC CHARACTERISTICS – LIN TRANSMITTER

$V_{LIN_dom_LoSup}$	LIN dominant output voltage	TxD = Low; $V_{BB} = 7.3\text{ V}$			1.2	V
$V_{LIN_dom_HiSup}$	LIN dominant output voltage	TxD = Low; $V_{BB} = 18\text{ V}$			2.0	V
V_{LIN_rec}	LIN recessive output voltage (Note 13)	TxD = High; $I_{LIN} = 10\text{ }\mu\text{A}$	$V_{BB} - 1.5$		V_{BB}	V
I_{LIN_lim}	Short circuit current limitation	$V_{LIN} = V_{BB(max)}$	40		200	mA
R_{slave}	Internal pull-up resistance		20	33	47	k Ω
C_{LIN}	Capacitance on pin LIN (Note 14)			25	35	pF

DC CHARACTERISTICS – LIN RECEIVER

V_{BUS_dom}	bus voltage for dominant state				0.4	V_{BB}
V_{BUS_rec}	bus voltage for recessive state		0.6			V_{BB}
V_{rec_dom}	Receiver threshold	LIN bus recessive \rightarrow dominant	0.4		0.6	V_{BB}
V_{rec_rec}	Receiver threshold	LIN bus dominant \rightarrow recessive	0.4		0.6	V_{BB}
V_{rec_cnt}	Receiver centre voltage	$(V_{rec_dom} + V_{rec_rec}) / 2$	0.475		0.525	V_{BB}
V_{rec_hys}	Receiver hysteresis	$(V_{rec_rec} - V_{rec_dom})$	0.05		0.175	V_{BB}
$I_{LIN_off_dom}$	LIN output current bus in dominant state	Driver off; $V_{BB} = 12\text{ V}$, $V_{LIN} = 0\text{ V}$	-1			mA
$I_{LIN_off_rec}$	LIN output current bus in recessive state	Driver off; $V_{BB} < 18\text{ V}$, $V_{BB} < V_{LIN} < 18\text{ V}$			1	μA
$I_{LIN_no_GND}$	Communication not affected	$V_{BB} = GND = 12\text{ V}$; $0 < V_{LIN} < 18\text{ V}$	-1		1	mA
$I_{LIN_no_VBB}$	LIN bus remains operational	$V_{BB} = GND = 0\text{ V}$; $0 < V_{LIN} < 18\text{ V}$			5	μA

DC CHARACTERISTICS – DIGITAL I/O PINS

PIN WAKE

V_{WAKE_TH}	Threshold voltage		0.35		0.65	V_{BB}
I_{leak}	Input leakage current	$V_{WAKE} = 0\text{ V}$; $V_{BB} = 18\text{ V}$	-1	-0.5	1	μA
$t_{WAKE(min)}$	Debounce time	Sleep mode; rising and falling edge	8		54	μs

PINS TxD AND STB

V_{il}	Low level input voltage				0.8	V
V_{ih}	High level input voltage		2.0			V
R_{pu}	Pull-up resistance to V_{CC}		50		200	k Ω

12. Measured at output voltage $V_{CC_OUT} = (V_{CC_OUT} @ V_{BB} = 5\text{ V}) - 2\%$.

13. The voltage drop in Normal mode between LIN and V_{BB} pin is the sum of the diode drop and the drop at serial pull-up resistor. The drop at the switch is negligible. See Figure 2.

14. Guaranteed by design. Not tested

NCV7425

Table 6. DC CHARACTERISTICS – 3.3 V VERSION

$V_{BB} = 5\text{ V to }28\text{ V}$; $T_J = -40^\circ\text{C to }+150^\circ\text{C}$; unless otherwise specified.

Symbol	Parameter	Conditions	Min	Typ	Max	Unit
--------	-----------	------------	-----	-----	-----	------

DC CHARACTERISTICS – DIGITAL I/O PINS

PIN INH

ΔV_H	High level voltage drop	$I_{INH} = 15\text{ mA}$		0.35	0.75	V
I_{leak}	Leakage current	Sleep mode; $V_{INH} = 0\text{ V}$	-1		1	μA

PIN EN

V_{il}	Low level input voltage				0.8	V
V_{ih}	High level input voltage		2.0			V
R_{pd}	Pull-down resistance to ground		50		200	$\text{k}\Omega$

PIN RxD

V_{ol}	Low level output voltage	$I_{sink} = 2\text{ mA}$			0.65	V
V_{oh}	High level output voltage (In Normal mode)	Normal mode, $I_{source} = -2\text{ mA}$	$V_{CC} - 0.65$			V
R_{pu}	Pull-up resistance to V_{CC} (In Standby and Sleep mode)	Standby mode, Sleep mode		10		$\text{k}\Omega$

PIN RSTN

V_{ol}	Low level output voltage	$I_{sink} = 2\text{ mA}$			0.65	V
R_{pu}	Pull-up resistance to V_{CC}		50		200	$\text{k}\Omega$

DC CHARACTERISTICS

POWER-ON RESET

POR_{H_VBB}	V_{BB} POR High level detection threshold				4.5	V
POR_{L_VBB}	V_{BB} POR Low level detection threshold		1.7		3.8	V
$POR_{_VBB_sl}$	Maximum slope on V_{BB} to guarantee POR				2	$\text{V}/\mu\text{s}$

THERMAL SHUTDOWN

T_{J_tsd}	Thermal shutdown junction temperature	For shutdown	165		195	$^\circ\text{C}$
T_{J_hyst}	Thermal shutdown hysteresis		9		18	$^\circ\text{C}$

12. Measured at output voltage $V_{CC_OUT} = (V_{CC_OUT} @ V_{BB} = 5\text{ V}) - 2\%$.

13. The voltage drop in Normal mode between LIN and V_{BB} pin is the sum of the diode drop and the drop at serial pull-up resistor. The drop at the switch is negligible. See Figure 2.

14. Guaranteed by design. Not tested

NCV7425

Table 7. DC CHARACTERISTICS – 5 V VERSION

$V_{BB} = 6\text{ V to }28\text{ V}$; $T_J = -40^\circ\text{C to }+150^\circ\text{C}$; unless otherwise specified.

Symbol	Parameter	Conditions	Min	Typ	Max	Unit
--------	-----------	------------	-----	-----	-----	------

DC CHARACTERISTICS SUPPLY – PINS V_{BB} AND V_{CC}

I_{BB_ON}	Supply current	Normal mode; LIN recessive			1.6	mA
I_{BB_STB}	Supply current	Standby mode, $V_{BB} = 6 - 18\text{ V}$, $T_J < 105^\circ\text{C}$			60	μA
I_{BB_SLP}	Supply current	Sleep mode, $V_{BB} = 6 - 18\text{ V}$, $T_J < 105^\circ\text{C}$			20	μA

DC CHARACTERISTICS – VOLTAGE REGULATOR

V_{CC_OUT}	Regulator output voltage	V_{CC} load 0 – 100 mA	4.9	5	5.1	V
		100 mA < V_{CC} load < 150 mA	4.85	5	5.15	V
I_{OUT_LIM}	Overcurrent limitation		150	225	300	mA
$V_{CC_UV_THR}$	Undervoltage detection threshold		4.25	4.5	4.75	V
ΔV_{CC_OUT}	Line Regulation	$V_{BB} 6 - 28\text{ V}$, $I_{out} = 5\text{ mA}$, $T_J = 25^\circ\text{C}$		0.41		mV
	Load Regulation	$I_{out} 1 - 100\text{ mA}$, $V_{BB} = 14\text{ V}$, $T_J = 25^\circ\text{C}$		22		mV
V_{do}	Dropout Voltage ($V_{BB} - V_{CC_OUT}$) (Note 15) (Figure 20)	$I_{out} = 10\text{ mA}$, $T_J = 25^\circ\text{C}$		22		mV
		$I_{out} = 50\text{ mA}$, $T_J = 25^\circ\text{C}$		108		mV
		$I_{out} = 100\text{ mA}$, $T_J = 25^\circ\text{C}$		216		mV

DC CHARACTERISTICS LIN TRANSMITTER

$V_{LIN_dom_LoSup}$	LIN dominant output voltage	TxD = Low; $V_{BB} = 7.3\text{ V}$			1.2	V
$V_{LIN_dom_HiSup}$	LIN dominant output voltage	TxD = Low; $V_{BB} = 18\text{ V}$			2.0	V
V_{LIN_rec}	LIN recessive output voltage (Note 16)	TxD = High; $I_{LIN} = 10\ \mu\text{A}$	$V_{BB} - 1.5$		V_{BB}	V
I_{LIN_lim}	Short circuit current limitation	$V_{LIN} = V_{BB(max)}$	40		200	mA
R_{slave}	Internal pull-up resistance		20	33	47	k Ω
C_{LIN}	Capacitance on pin LIN (Note 17)			25	35	pF

DC CHARACTERISTICS LIN RECEIVER

V_{BUS_dom}	bus voltage for dominant state				0.4	V_{BB}
V_{BUS_rec}	bus voltage for recessive state		0.6			V_{BB}
V_{rec_dom}	Receiver threshold	LIN bus recessive \rightarrow dominant	0.4		0.6	V_{BB}
V_{rec_rec}	Receiver threshold	LIN bus dominant \rightarrow recessive	0.4		0.6	V_{BB}
V_{rec_cnt}	Receiver center voltage	$(V_{rec_dom} + V_{rec_rec}) / 2$	0.475		0.525	V_{BB}
V_{rec_hys}	Receiver hysteresis	$(V_{rec_rec} - V_{rec_dom})$	0.05		0.175	V_{BB}
$I_{LIN_off_dom}$	LIN output current bus in dominant state	Driver off; $V_{BB} = 12\text{ V}$, $V_{LIN} = 0\text{ V}$	-1			mA
$I_{LIN_off_rec}$	LIN output current bus in recessive state	Driver off; $V_{BB} < 18\text{ V}$, $V_{BB} < V_{LIN} < 18\text{ V}$			1	μA
$I_{LIN_no_GND}$	Communication not affected	$V_{BB} = GND = 12\text{ V}$; $0 < V_{LIN} < 18\text{ V}$	-1		1	mA
$I_{LIN_no_VBB}$	LIN bus remains operational	$V_{BB} = GND = 0\text{ V}$; $0 < V_{LIN} < 18\text{ V}$			5	μA

15. Measured at output voltage $V_{CC_OUT} = (V_{CC_OUT} @ V_{BB} = 6\text{ V}) - 2\%$.

16. The voltage drop in Normal mode between LIN and V_{BB} pin is the sum of the diode drop and the drop at serial pull-up resistor. The drop at the switch is negligible. See Figure 2.

17. Guaranteed by design. Not tested

NCV7425

Table 7. DC CHARACTERISTICS – 5 V VERSION

$V_{BB} = 6\text{ V to }28\text{ V}$; $T_J = -40^\circ\text{C to }+150^\circ\text{C}$; unless otherwise specified.

Symbol	Parameter	Conditions	Min	Typ	Max	Unit
--------	-----------	------------	-----	-----	-----	------

DC CHARACTERISTICS – DIGITAL I/O PINS

PIN WAKE

V_{WAKE_TH}	Threshold voltage		0.35		0.65	V_{BB}
I_{leak}	Input leakage current	$V_{WAKE} = 0\text{ V}$; $V_{BB} = 18\text{ V}$	-1	-0.5	1	μA
t_{WAKE_MIN}	Debounce time	Sleep mode; rising and falling edge	8		54	μs

PINS TxD AND STB

V_{il}	Low level input voltage				0.8	V
V_{ih}	High level input voltage		2.0			V
R_{pu}	Pull-up resistance to V_{CC}		50		200	$k\Omega$

PIN INH

ΔV_H	High level voltage drop	$I_{INH} = 15\text{ mA}$		0.35	0.75	V
I_{leak}	Leakage current	Sleep mode; $V_{INH} = 0\text{ V}$	-1		1	μA

PIN EN

V_{il}	Low level input voltage				0.8	V
V_{ih}	High level input voltage		2.0			V
R_{pd}	Pull-down resistance to ground		50		200	$k\Omega$

PIN RxD

V_{ol}	Low level output voltage	$I_{sink} = 2\text{ mA}$			0.65	V
V_{oh}	High level output voltage (In Normal mode)	Normal mode, $I_{source} = -2\text{ mA}$	$V_{CC} - 0.65$			V
R_{pu}	Pull-up resistance to V_{CC} (In Standby and Sleep mode)	Standby mode, Sleep mode		10		$k\Omega$

PIN RSTN

V_{ol}	Low level output voltage	$I_{sink} = 2\text{ mA}$			0.65	V
R_{pu}	Pull-up resistance to V_{CC}		50		200	$k\Omega$

DC CHARACTERISTICS

POWER-ON RESET

$POR_H_V_{BB}$	V_{BB} POR High level detection threshold				4.5	V
$POR_L_V_{BB}$	V_{BB} POR Low level detection threshold		1.7		3.8	V
$POR_V_{BB_sl}$	Maximum slope on V_{BB} to guarantee POR				2	$\text{V}/\mu\text{s}$

THERMAL SHUTDOWN

T_{J_tsd}	Thermal shutdown junction temperature	For shutdown	165		195	$^\circ\text{C}$
T_{J_hyst}	Thermal shutdown hysteresis		9		18	$^\circ\text{C}$

15. Measured at output voltage $V_{CC_OUT} = (V_{CC_OUT} @ V_{BB} = 6\text{ V}) - 2\%$.

16. The voltage drop in Normal mode between LIN and V_{BB} pin is the sum of the diode drop and the drop at serial pull-up resistor. The drop at the switch is negligible. See Figure 2.

17. Guaranteed by design. Not tested

NCV7425

Table 8. AC CHARACTERISTICS – 3.3 V AND 5 V VERSIONS

$V_{BB} = 7\text{ V to }18\text{ V}$; $T_J = -40^\circ\text{C to }+150^\circ\text{C}$; unless otherwise specified.

Symbol	Parameter	Conditions	Min	Typ	Max	Unit
AC CHARACTERISTICS LIN TRANSMITTER						
D1	Duty Cycle 1 = $t_{BUS_rec(min)} / (2 \times t_{Bit})$ see Figure 24	Normal slope mode $TH_{rec(max)} = 0.744 \times V_{BB}$ $TH_{dom(max)} = 0.581 \times V_{BB}$ $t_{Bit} = 50\ \mu\text{s}$ $V_{BB} = 7\text{ V to }18\text{ V}$	0.396		0.5	
D2	Duty Cycle 2 = $t_{BUS_rec(max)} / (2 \times t_{Bit})$ see Figure 24	Normal slope mode $TH_{rec(min)} = 0.422 \times V_{BB}$ $TH_{dom(min)} = 0.284 \times V_{BB}$ $t_{Bit} = 50\ \mu\text{s}$ $V_{BB} = 7.6\text{ V to }18\text{ V}$	0.5		0.581	
D3	Duty Cycle 3 = $t_{BUS_rec(min)} / (2 \times t_{Bit})$ see Figure 24	Normal slope mode $TH_{rec(max)} = 0.778 \times V_{BB}$ $TH_{dom(max)} = 0.616 \times V_{BB}$ $t_{Bit} = 96\ \mu\text{s}$ $V_{BB} = 7\text{ V to }18\text{ V}$	0.417		0.5	
D4	Duty Cycle 4 = $t_{BUS_rec(max)} / (2 \times t_{Bit})$ see Figure 24	Normal slope mode $TH_{rec(min)} = 0.389 \times V_{BB}$ $TH_{dom(min)} = 0.251 \times V_{BB}$ $t_{Bit} = 96\ \mu\text{s}$ $V_{BB} = 7.6\text{ V to }18\text{ V}$	0.5		0.590	
t_{fall_norm}	LIN falling edge	Normal slope mode; $V_{BB} = 12\text{ V}$; L1, L2 (Note 18)			22.5	μs
t_{rise_norm}	LIN rising edge	Normal slope mode; $V_{BB} = 12\text{ V}$; L1, L2 (Note 18)			22.5	μs
t_{sym_norm}	LIN slope symmetry	Normal slope mode; $V_{BB} = 12\text{ V}$; L1, L2 (Note 18)	-4		4	μs
t_{fall_norm}	LIN falling edge	Normal slope mode; $V_{BB} = 12\text{ V}$; L3 (Note 18)			27	μs
t_{rise_norm}	LIN rising edge	Normal slope mode; $V_{BB} = 12\text{ V}$; L3 (Note 18)			27	μs
t_{sym_norm}	LIN slope symmetry	Normal slope mode; $V_{BB} = 12\text{ V}$; L3 (Note 18)	-5		5	μs
t_{fall_low}	LIN falling edge	Low slope mode (Note 19); $V_{BB} = 12\text{ V}$; L3 (Note 18)			62	μs
t_{rise_low}	LIN rising edge	Low slope mode (Note 19); $V_{BB} = 12\text{ V}$; L3 (Note 18)			62	μs
t_{WAKE}	Dominant timeout for wake-up via LIN bus		30		150	μs
t_{dom}	TxD dominant timeout	TxD = Low	6		20	ms
$V_{CC_UV_deb}$	V_{CC} undervoltage detection debounce time		1.5	5	10	μs
$RSTN_{ext}$	Extension time of RSTN Low pulse beyond V_{CC} undervoltage		3	6	10	ms

AC CHARACTERISTICS LIN RECEIVER

$t_{rec_prop_down}$	Propagation delay of receiver falling edge		0.1		6	μs
$t_{rec_prop_up}$	Propagation delay of receiver rising edge		0.1		6	μs
t_{rec_sym}	Propagation delay symmetry	$t_{rec_prop_down} - t_{rec_prop_up}$	-2		2	μs

18. The AC parameters are specified for following RC loads on the LIN bus: L1 = 1 k Ω / 1 nF; L2 = 660 Ω / 6.8 nF; L3 = 500 Ω / 10 nF.

19. Low slope mode is not compliant to the LIN 1.3 or LIN 2.0/2.1 standard.

REGULATOR TYPICAL PERFORMANCE CHARACTERISTICS

(3.3 V Version)

Load Transient Responses

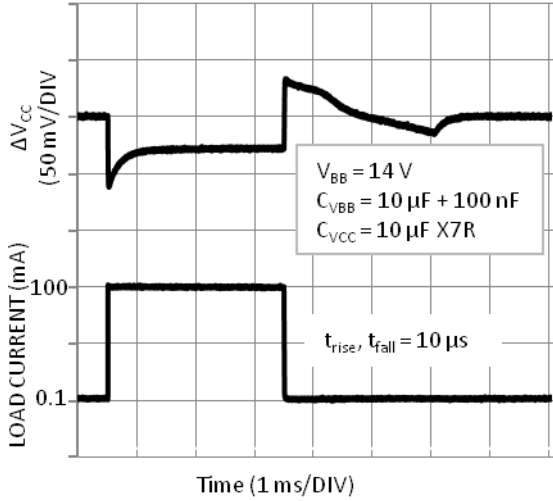

Figure 8. Load Transient Response
(I_{CC} 100 μ A to 100 mA)

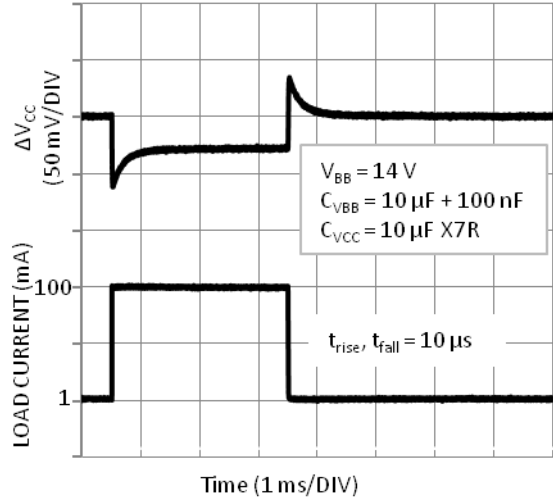

Figure 9. Load Transient Response
(I_{CC} 1 mA to 100 mA)

Line Transient Responses

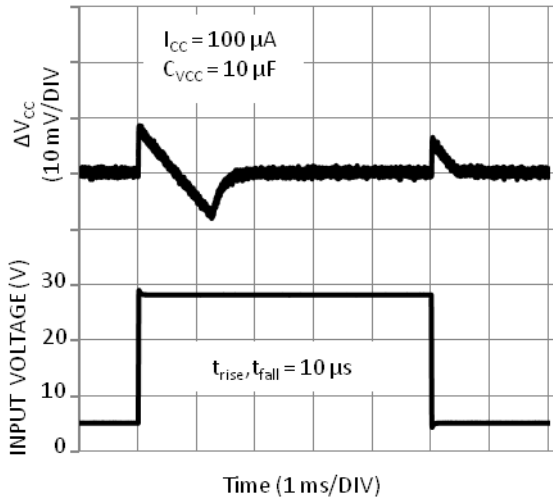

Figure 10. Line Transient Response
(V_{BB} 5 V to 28 V)

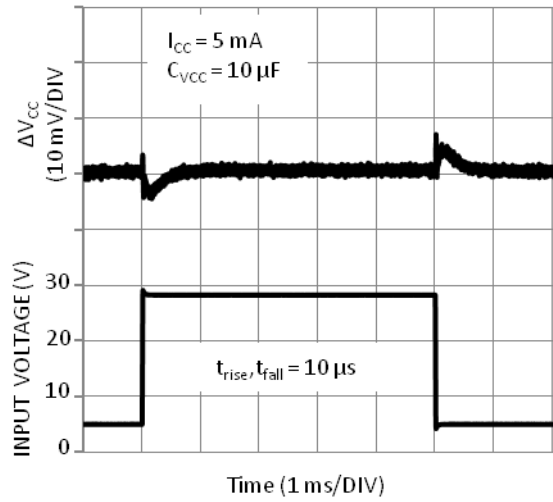

Figure 11. Line Transient Response
(V_{BB} 5 V to 28 V)

REGULATOR TYPICAL PERFORMANCE CHARACTERISTICS

(3.3 V Version)

Static Characteristics

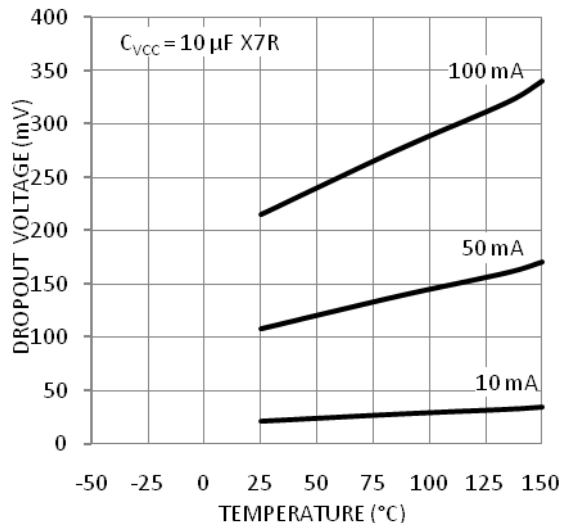

Figure 12. Dropout Voltage vs. Temperature

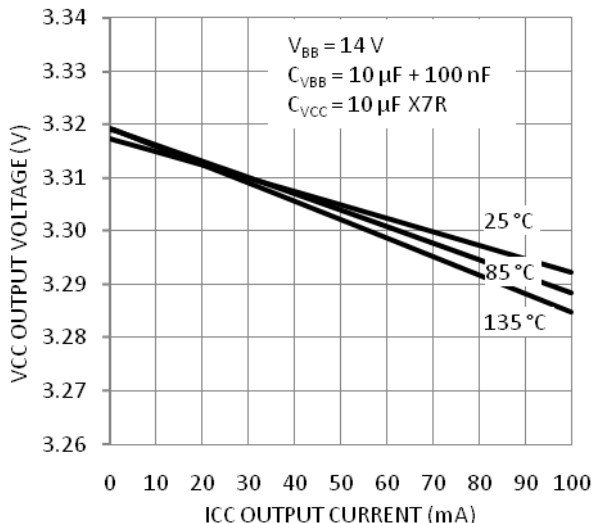

Figure 13. Output Voltage vs. Output Current

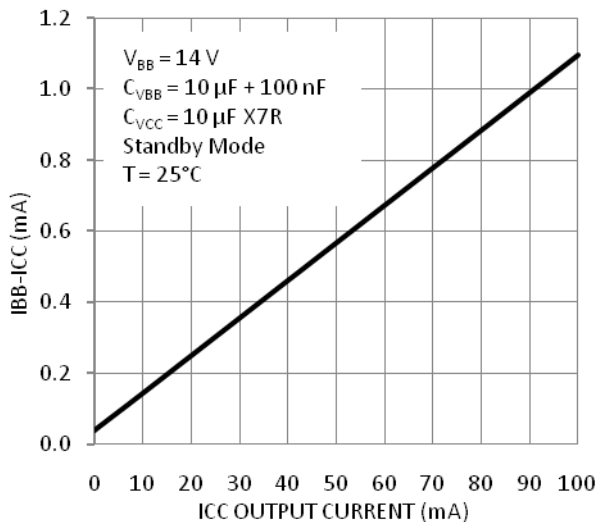

Figure 14. Ground Current vs. Output Current

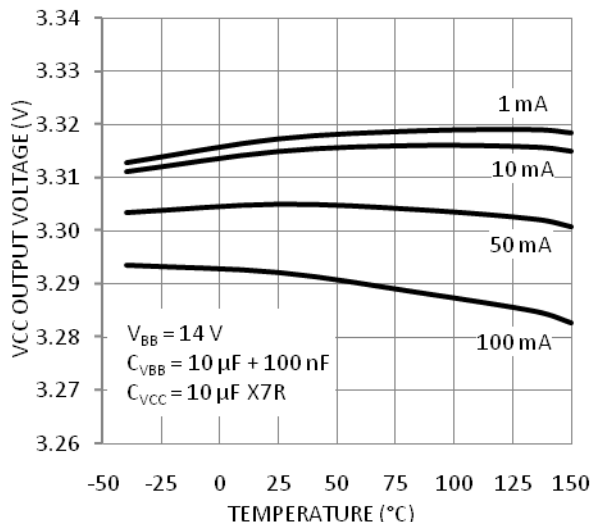

Figure 15. Output Voltage vs. Temperature

REGULATOR TYPICAL PERFORMANCE CHARACTERISTICS

(5 V Version)

Load Transient Responses

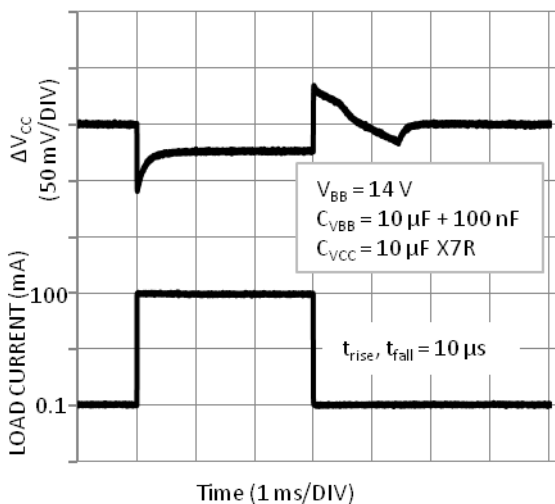

Figure 16. Load Transient Response
(I_{CC} 100 μ A to 100 mA)

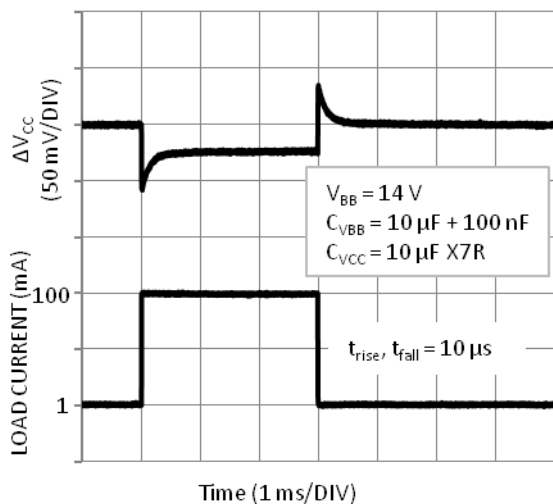

Figure 17. Load Transient Response
(I_{CC} 1 mA to 100 mA)

Line Transient Responses

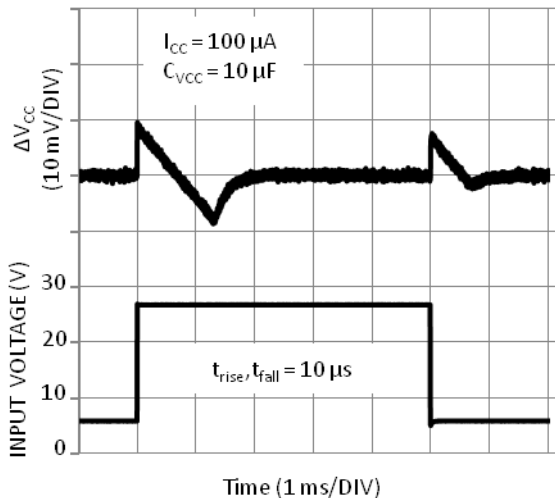

Figure 18. Line Transient Response
(V_{BB} 6 V to 28 V)

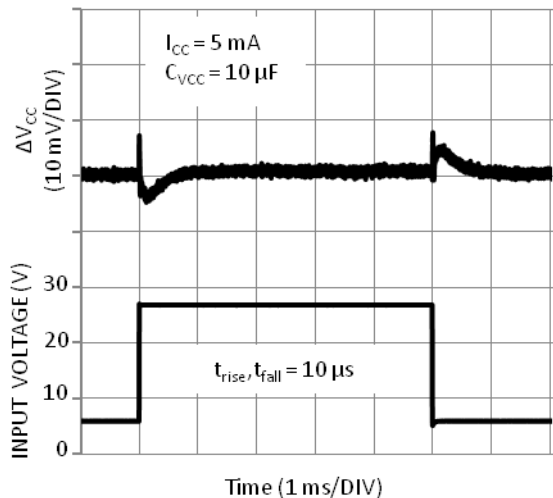

Figure 19. Line Transient Response
(V_{BB} 6 V to 28 V)

REGULATOR TYPICAL PERFORMANCE CHARACTERISTICS

(5 V Version)

Static Characteristics

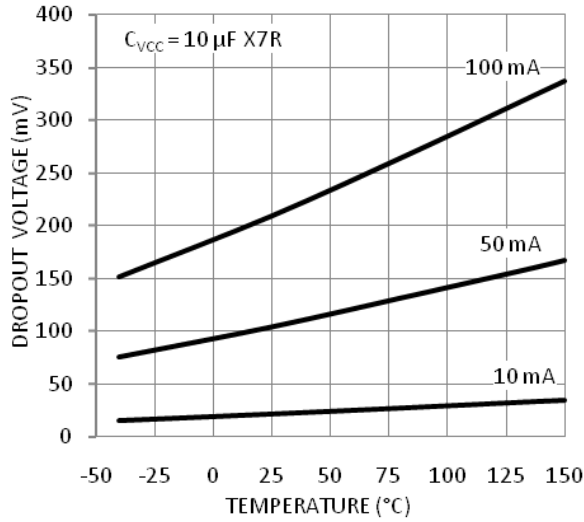

Figure 20. Dropout Voltage vs. Temperature

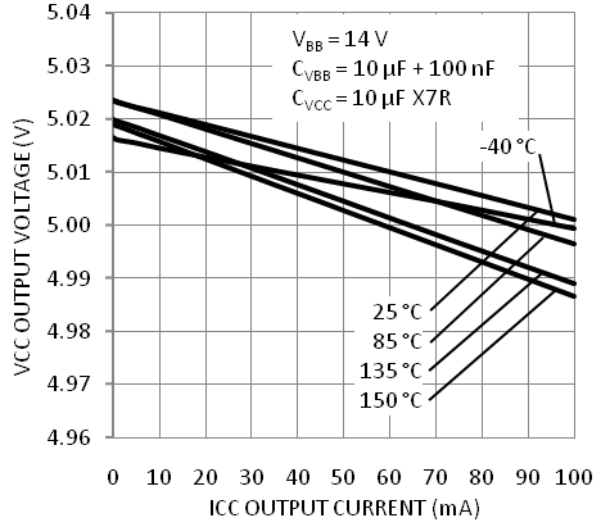

Figure 21. Output Voltage vs. Output Current

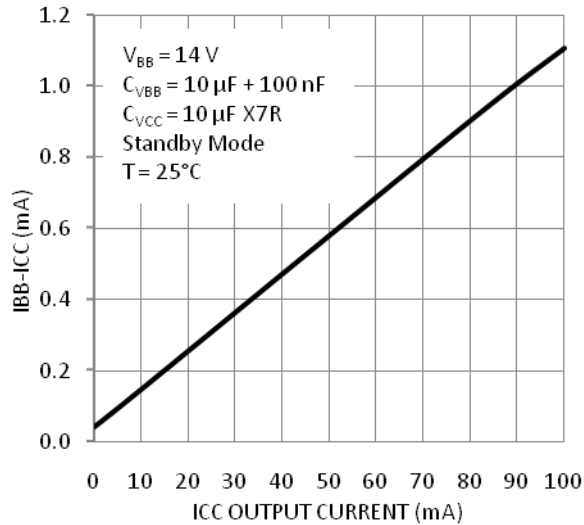

Figure 22. Ground Current vs. Output Current

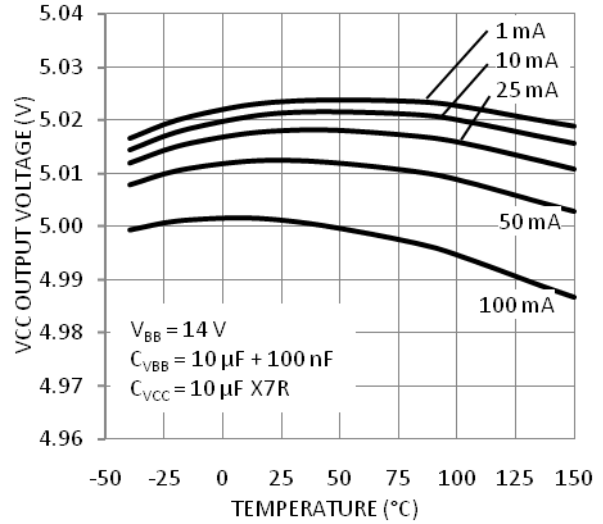

Figure 23. Output Voltage vs. Temperature

NCV7425

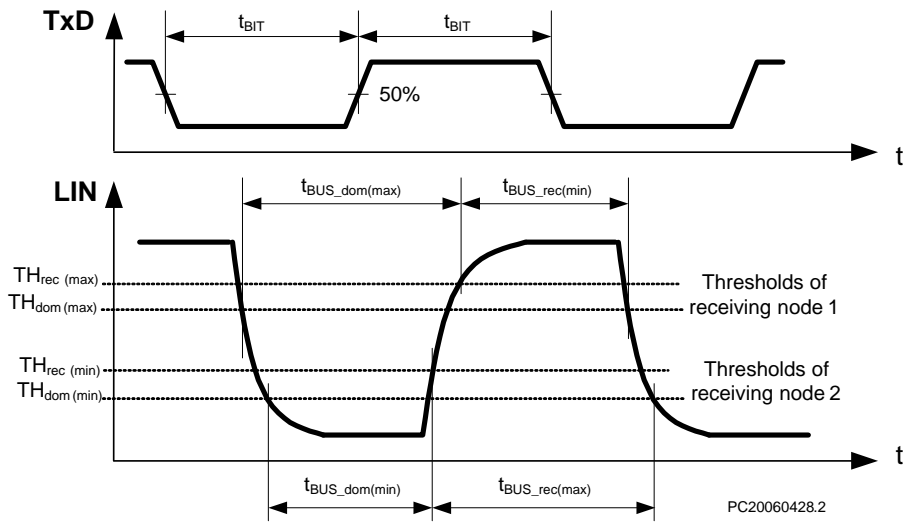

Figure 24. LIN Transmitter Duty Cycle

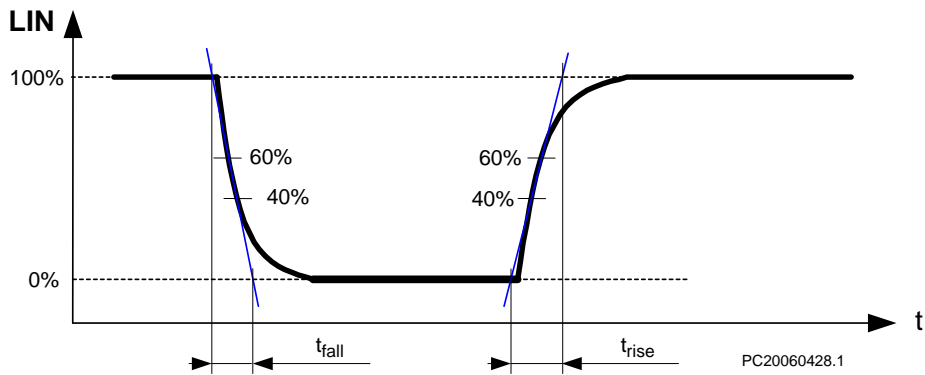

Figure 25. LIN Transmitter Rising and Falling Times

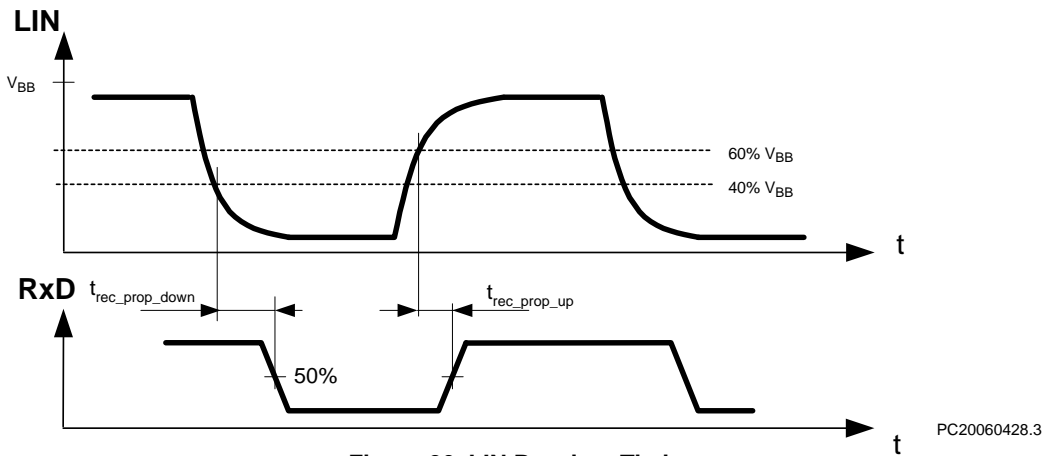

Figure 26. LIN Receiver Timing

NCV7425

ORDERING INFORMATION

Device	Description	Temperature Range	Package	Shipping†
NCV7425DW0G	LIN Transceiver + 3.3 V Regulator + Reset Pin	-40°C to 125°C	SOIC-16 WB EP (Pb-Free)	46 Units / Tube
NCV7425DW0R2G				1500 / Tape & Reel
NCV7425DW5G	LIN Transceiver + 5 V Regulator + Reset Pin			46 Units / Tube
NCV7425DW5R2G				1500 / Tape & Reel

†For information on tape and reel specifications, including part orientation and tape sizes, please refer to our Tape and Reel Packaging Specifications Brochure, BRD8011/D.

MECHANICAL CASE OUTLINE

PACKAGE DIMENSIONS

ON Semiconductor®

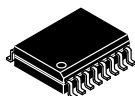

SOIC 16 LEAD WIDE BODY, EXPOSED PAD CASE 751AG ISSUE B

DATE 31 MAY 2016

SCALE 1:1

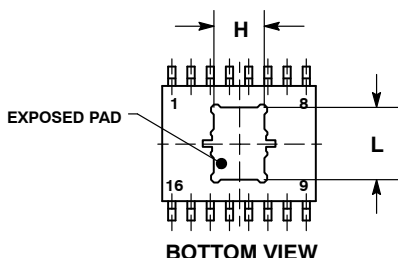
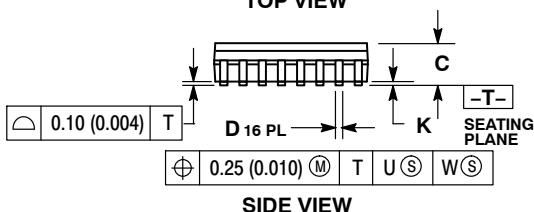
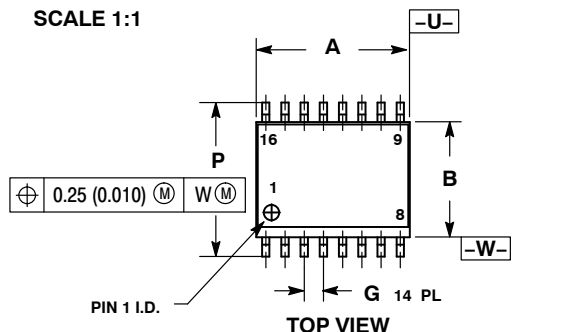

SOLDERING FOOTPRINT*

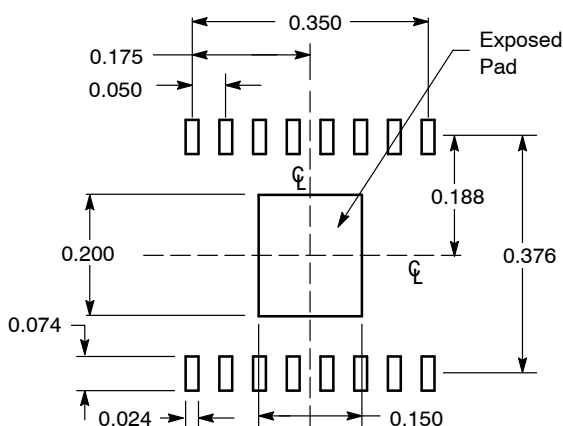

DIMENSIONS: INCHES

*For additional information on our Pb-Free strategy and soldering details, please download the ON Semiconductor Soldering and Mounting Techniques Reference Manual, SOLDERRM/D.

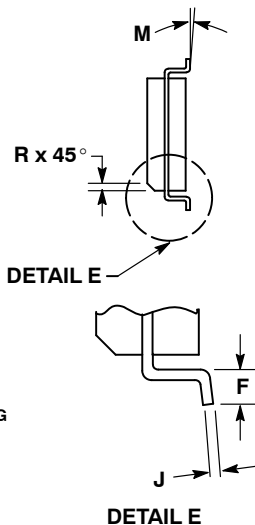

NOTES:

1. DIMENSIONING AND TOLERANCING PER ANSI Y14.5M, 1982.
2. CONTROLLING DIMENSION: MILLIMETER.
3. DIMENSION A AND B DO NOT INCLUDE MOLD PROTRUSION.
4. MAXIMUM MOLD PROTRUSION 0.15 (0.006) PER SIDE.
5. DIMENSION D DOES NOT INCLUDE DAMBAR PROTRUSION. ALLOWABLE PROTRUSION SHALL BE 0.13 (0.005) TOTAL IN EXCESS OF THE D DIMENSION AT MAXIMUM MATERIAL CONDITION.
6. 751R-01 OBSOLETE, NEW STANDARD 751R-02.

DIM	MILLIMETERS		INCHES	
	MIN	MAX	MIN	MAX
A	10.15	10.45	0.400	0.411
B	7.40	7.60	0.292	0.299
C	2.35	2.65	0.093	0.104
D	0.35	0.49	0.014	0.019
F	0.50	0.90	0.020	0.035
G	1.27 BSC		0.050 BSC	
H	3.45	3.66	0.136	0.144
J	0.25	0.32	0.010	0.012
K	0.00	0.10	0.000	0.004
L	4.72	4.93	0.186	0.194
M	0°	7°	0°	7°
P	10.05	10.55	0.395	0.415
R	0.25	0.75	0.010	0.029

GENERIC MARKING DIAGRAM*

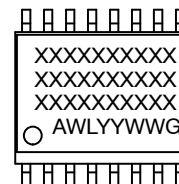

- XXXXXX = Specific Device Code
- A = Assembly Location
- WL = Wafer Lot
- YY = Year
- WW = Work Week
- G = Pb-Free Package

*This information is generic. Please refer to device data sheet for actual part marking. Pb-Free indicator, "G" or microdot "▪", may or may not be present.

DOCUMENT NUMBER:	98AON21237D	Electronic versions are uncontrolled except when accessed directly from the Document Repository. Printed versions are uncontrolled except when stamped "CONTROLLED COPY" in red.
DESCRIPTION:	SOIC-16, WB EXPOSED PAD	PAGE 1 OF 1

ON Semiconductor and ON are trademarks of Semiconductor Components Industries, LLC dba ON Semiconductor or its subsidiaries in the United States and/or other countries. ON Semiconductor reserves the right to make changes without further notice to any products herein. ON Semiconductor makes no warranty, representation or guarantee regarding the suitability of its products for any particular purpose, nor does ON Semiconductor assume any liability arising out of the application or use of any product or circuit, and specifically disclaims any and all liability, including without limitation special, consequential or incidental damages. ON Semiconductor does not convey any license under its patent rights nor the rights of others.

onsemi, **Onsemi**, and other names, marks, and brands are registered and/or common law trademarks of Semiconductor Components Industries, LLC dba "**onsemi**" or its affiliates and/or subsidiaries in the United States and/or other countries. **onsemi** owns the rights to a number of patents, trademarks, copyrights, trade secrets, and other intellectual property. A listing of **onsemi**'s product/patent coverage may be accessed at www.onsemi.com/site/pdf/Patent-Marking.pdf. **onsemi** reserves the right to make changes at any time to any products or information herein, without notice. The information herein is provided "as-is" and **onsemi** makes no warranty, representation or guarantee regarding the accuracy of the information, product features, availability, functionality, or suitability of its products for any particular purpose, nor does **onsemi** assume any liability arising out of the application or use of any product or circuit, and specifically disclaims any and all liability, including without limitation special, consequential or incidental damages. Buyer is responsible for its products and applications using **onsemi** products, including compliance with all laws, regulations and safety requirements or standards, regardless of any support or applications information provided by **onsemi**. "Typical" parameters which may be provided in **onsemi** data sheets and/or specifications can and do vary in different applications and actual performance may vary over time. All operating parameters, including "Typicals" must be validated for each customer application by customer's technical experts. **onsemi** does not convey any license under any of its intellectual property rights nor the rights of others. **onsemi** products are not designed, intended, or authorized for use as a critical component in life support systems or any FDA Class 3 medical devices or medical devices with a same or similar classification in a foreign jurisdiction or any devices intended for implantation in the human body. Should Buyer purchase or use **onsemi** products for any such unintended or unauthorized application, Buyer shall indemnify and hold **onsemi** and its officers, employees, subsidiaries, affiliates, and distributors harmless against all claims, costs, damages, and expenses, and reasonable attorney fees arising out of, directly or indirectly, any claim of personal injury or death associated with such unintended or unauthorized use, even if such claim alleges that **onsemi** was negligent regarding the design or manufacture of the part. **onsemi** is an Equal Opportunity/Affirmative Action Employer. This literature is subject to all applicable copyright laws and is not for resale in any manner.

PUBLICATION ORDERING INFORMATION

LITERATURE FULFILLMENT:

Email Requests to: orderlit@onsemi.com

onsemi Website: www.onsemi.com

TECHNICAL SUPPORT

North American Technical Support:
Voice Mail: 1 800-282-9855 Toll Free USA/Canada
Phone: 011 421 33 790 2910

Europe, Middle East and Africa Technical Support:

Phone: 00421 33 790 2910

For additional information, please contact your local Sales Representative