

Self-Test Appliance Leakage Circuit Interrupter (ALCI)

NCS37020

The NCS37020 is an UL943B compliant signal processor for ALCI applications with self-test. The device integrates a 12 V shunt power supply, tiered differential fault detection and self-test per the UL943B standard. Self-test is monitored at start up and every 12 minutes.

Features

- Meets UL943B Self-test ALCI Requirements
- 12 V Shunt Regulator
- Precision Bandgap
- 3.3 V LDO Linear Regulator
- CT Sense Amplifier V_{OS} Dynamic Cancellation
- Oscillator Frequency Trimmed to AC Input
- Tiered GF Trip Times
- Built-In Noise Filter
- LED EOL Indicator
- SCR Gate Driver
- Adjustable Sensitivity
- Minimum External Components
- Low Quiescent Current
- 14 Pin TSSOP Package

Typical Applications

- Personal Care Products
- Non Grounded Neutral Electrical Outlets, Circuit Breakers and Power Cords Requiring Ground Fault Safety Features
- ALCI and RCCB Circuits



ON Semiconductor®

www.onsemi.com

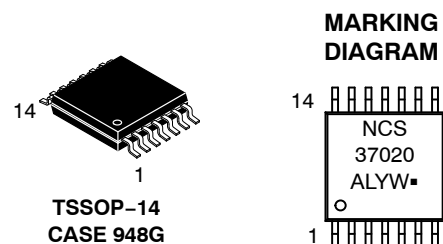

A = Assembly Location
L = Wafer Lot
Y = Year
W = Work Week
▪ = Pb-Free Package

PIN CONNECTIONS

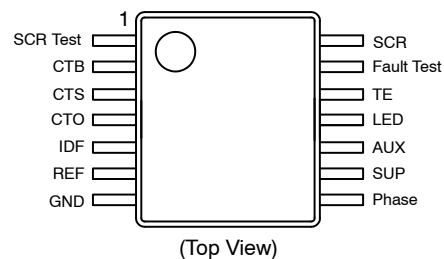

ORDERING INFORMATION

Device	Package	Shipping†
NCS37020DTBR2G	TSSOP-14 (Pb-Free)	2500 / Tape & Reel

†For information on tape and reel specifications, including part orientation and tape sizes, please refer to our Tape and Reel Packaging Specifications Brochure, BRD8011/D.

NCS37020

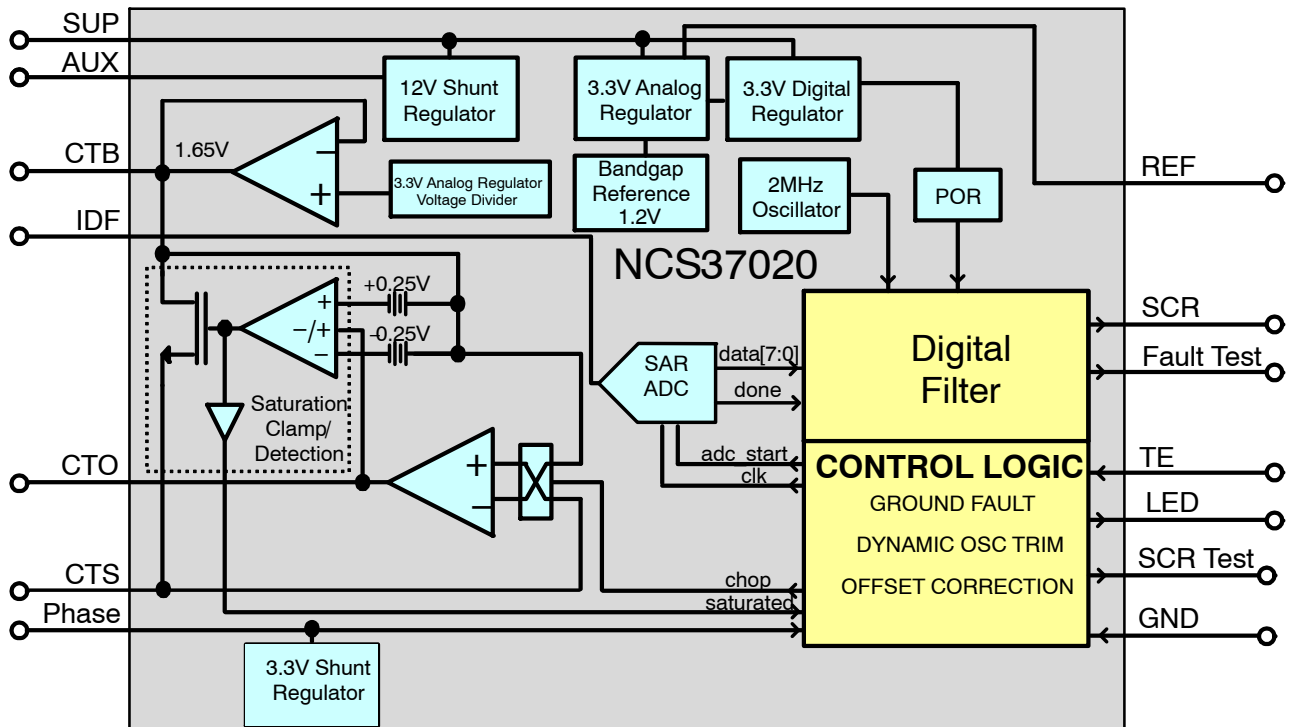

Figure 1. Simplified Block Diagram

Table 1. TSSOP PIN DESCRIPTION

Pin #	Name	Pad Description
1	SCR Test	SCR test input for SCR functionality
2	CTB	Differential current transformer bias voltage
3	CTS	Differential current signal input
4	CTO	Differential current to voltage output
5	IDF	Differential low pass filter/ADC input
6	REF	3.3 V Internal reference voltage
7	GND	Electronics ground
8	Phase	Zero cross input for V_{AC} frequency
9	SUP	Power supply input
10	AUX	Auxiliary power supply input
11	LED	End of life LED drive
12	TE	Test enable, Connect to GND
13	Fault Test	Differential self-test output signal
14	SCR	SCR gate drive signal

NCS37020

Table 2. ABSOLUTE MAXIMUM RATINGS

Rating	Symbol	Value	Unit
Supply Voltage Range	V _s	13.5	V
Supply Current	I _s	10	mA
Input Voltage Range (Note 3)	V _{in}	-0.3 to 3.6	V
Output Voltage Range	V _{out}	-0.3 to 3.6 V or (V _{in} + 0.3), whichever is lower	V
Maximum Junction Temperature	T _{J(max)}	140	°C
Storage Temperature Range	T _{STG}	-65 to 150	°C
ESD Capability, Human Body Model (Note 4)	ESD _{HBM}	2	kV
ESD Capability, Charge Device Model (Note 4)	ESD _{CDM}	500	V
Lead Temperature Soldering Reflow (SMD Styles Only), Pb-Free Versions (Note 5)	T _{SLD}	260	°C

Stresses exceeding those listed in the Maximum Ratings table may damage the device. If any of these limits are exceeded, device functionality should not be assumed, damage may occur and reliability may be affected.

1. Functional operation above the Recommended Operating Conditions is not implied. Extended
2. Exposure to stresses above the Recommended Operating Conditions may affect device reliability.
3. Refer to ELECTRICAL CHARACTERISTICS and APPLICATION INFORMATION for Safe Operating Area.
4. This device series incorporates ESD protection and is tested by the following methods:
 ESD Human Body Model tested per AEC-Q100-002 (JEDEC JS-001-2010)
 ESD Charge Device Model tested per AEC-Q100-003 (JESD22-C101-A)
 Latchup Current Maximum Rating: ≤100 mA, 20 μs pulse per JEDEC standard: JESD78
5. For information, please refer to our Soldering and Mounting Techniques Reference Manual, SOLDERRM.D

Table 3. THERMAL CHARACTERISTICS

Rating	Symbol	Value	Unit
Thermal Characteristics, TSSOP14 Thermal Resistance, Junction-to-Air (Note 6)	R _{θJA}	115	°C/W

6. Values based on copper area of 645 mm² (or 1 in²) of 1 oz copper thickness and FR4 PCB substrate.

NCS37020

Table 4. OPERATING RANGES (Unless otherwise noted, ISUP = 3 mA, Phase input = 60 Hz, Refer to Figure 2)

Parameter	Conditions	Min	Typ	Max	Units
Operating Temperature	Ambient	0		70	°C
Shunt Regulator Voltage	SUP to GND, ISUP = 1 mA		12	13	V
Shunt Regulator Current	ISUP			10	mA
Quiescent Current	ISUP, SUP = 10.5 V		575	800	μA
RMS Trip Threshold Voltage	IDF to CTB, R5 = 32 kΩ	191	203	215	mV
SCR Trigger Current	ISCR, SCR = 1 V, ISHUNT > 6 mA	4			mA
SCR Trigger Output Voltage	SCR to GND, SUP > 4 V	3		3.6	V
LED Output Voltage	LED to GND, SUP > 4 V	3		3.6	V
CTB Bias Voltage	CTB to GND, REF = 3.3 V		1.65		V
CTS-CTB Absolute Offset Voltage	CTS-CTB	-300		300	μV
Ground Fault Response Time	6 mA ≤ IDIFF < 15 mA			150	ms
Ground Fault Response Time	15 mA ≤ IDIFF < 30 mA			100	ms
Ground Fault Response Time	30 mA ≤ IDIFF < 100 mA			50	ms
Ground Fault Response Time	IDIFF ≥ 100 mA			25	ms
Internal Oscillator Frequency	FAC = 60 Hz +/- 0.1	1.8	2	2.2	MHz
Phase Pin Max Clamp Current	Iphase Max Sink Current			400	μA
Phase Pin Pull Down Current	Phase = 1 V		1		μA
First ST Timer	SUP > 4 V	0.75	1	1.25	seconds
Periodic ST Timer, Pass	Steady State, ST Pass	9	12	15	minutes
Periodic ST Timer, Fail	ST Fail	4	4.5	5	seconds
Consecutive ST Failure Timer	ST Fail Counter, Enable SCR		16		
LED Blink Frequency	ST Failure, EOL	3.6	4	4.4	Hz
ST Cycle GF Pass Window	IDIFF Ground Fault	5		15	mA
Phase Pin Check Wait Time to Enable EOL	No Phase signal		32		ms

Functional operation above the stresses listed in the Recommended Operating Ranges is not implied. Extended exposure to stresses beyond the Recommended Operating Ranges limits may affect device reliability.

NCS37020

APPLICATIONS INFORMATION

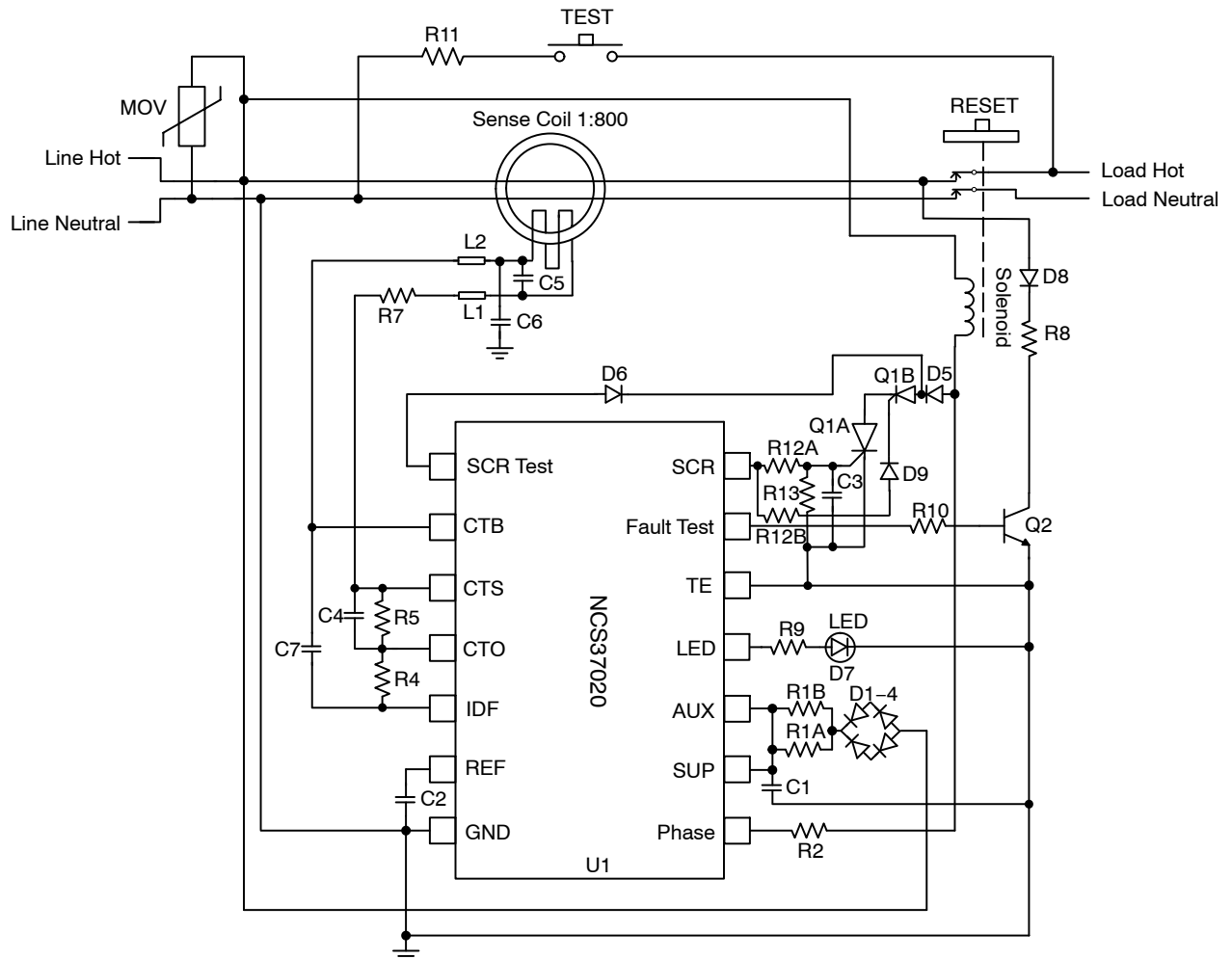

Figure 2. ALCI Application Diagram*

*Contact ON SEMI for additional filtering information

NCS37020

Table 5. RECOMMENDED EXTERNAL COMPONENTS

Component Type	Instance	Value	Note
Controller	U1	–	NCS37020DTBR2G
SCR	Q1A, Q1B	–	0.8 A, 400 V
NPN	Q2	–	MMBTA42
Diode Bridge	D1–D4	–	MB4S
Diode	D5	–	1 A, 300 V
Diode	D6, D8, D9	–	15 mA, 300 V
LED	D7	–	LED for EOL Indicator
Capacitor	C1	2.2 μ F	SUP pin holding capacitor, Ceramic 25 V
Capacitor	C2	1 μ F	REF filter capacitor, 6.3 V
Capacitor	C3	100 nF	SCR gate filter capacitor
Capacitor	C4	1 nF	Dynamic V_{OS} filter capacitor
Capacitor	C5	33 nF	CT filter capacitor
Capacitor	C6	2.2 nF	CTB bias capacitor
Capacitor	C7	22 to 56 nF	IDF filter capacitor
Resistor	R1A	49.9k Ω	Shunt regulator current limit resistor, $\frac{1}{4}$ W
Resistor	R1B	49.9k Ω	Shunt regulator current limit resistor, $\frac{1}{4}$ W
Resistor	R2	1 M Ω	AC zero cross current limit resistor
Resistor	R4	4.7 to 20 k Ω	IDF filter resistor
Resistor	R5	31.6 k Ω	Precision resistor (1%), Sets the differential trip level at 5 mA _{RMS}
Resistor	R7	243 Ω	Precision resistor (1%), Differential burden/CT low pass filter
Resistor	R8	10 k Ω	Sets the self-test GF current
Resistor	R9	3.3 k Ω	Current limit resistor for LED bias
Resistor	R10	4.7 k Ω	Current limit resistor for Q2 bias
Resistor	R11	15 k Ω	Sets the manual GF test current
Resistor	R12A	4.7 k Ω	Current limit resistor for Q1A bias
Resistor	R12B	3.3 k Ω	Current limit resistor for Q1B bias
Resistor	R13	4.7 k Ω	SCR gate bleeder resistor
Ferrite Bead	L1	1 k Ω @ 100 MHz	CIM05U102, CT RF filter
Ferrite Bead	L2	1 k Ω @ 100 MHz	CIM05U102, CT RF filter
Current Transformer	Sense Coil	800 turns	C5029–01C

Functional Description (refer to application circuit, Figure 2)

The NCS37020 provides for a single IC controller solution for ground fault protection and self-test auto monitoring per UL standard UL943B.

The key internal blocks include: 12 V shunt regulator, precision bandgap reference, two 3.3 V linear regulators (one for the digital and one for the analog circuit), CT sense amplifier with V_{OS} dynamic cancellation, 1.65 V reference for the CT, 2 MHz oscillator dynamically trimmed to the AC line frequency, 8 bit SAR ADC, comparators, digital filters and digital control logic.

The internal shunt regulator clamps the SUP pin voltage at 12 volts. This provides the bias voltage for the analog and digital internal circuitry via two 3.3 V linear regulators. The NCS37020 controller can be biased full wave or half wave. Figure 2 shows a half wave bias application. Half wave bias allows for lower wattage bias resistors (R1A and R1B) and less redundant bias diodes. The D1–4 diodes are biased so that only during the positive half cycle the capacitor C1 will be charged to 12 volts. During the negative half cycle, C1 will supply the bias current for the NCS37020. To minimize the NCS37020 bias current during the negative half cycle, the SCR and LED outputs will only be enabled during the positive half cycle. The D1–4 diodes and R1A–R1B resistors include redundant components to pass the UL943B standard.

At POR (power on reset) detection (SUP>4 V) the logic is reset and the bias circuitry is enabled. The Phase pin continually checks for an input signal. There is a 1 μA pull down internal current source connected to this pin so a floating or open pin will be biased low. If there is no 50/60 Hz signal detected on this pin for greater than 32 ms due to an open solenoid or open R2 resistor, a “no clock” End of Life (EOL) fault will occur. After ~150 ms, the LED indicator logic will be enabled and blink at 4 Hz. The SCR will be enabled for one positive half cycle every 4 seconds. The “no clock” EOL logic state will continue until a POR occurs or a 50/60 Hz signal is detected on the Phase pin. When a 50/60 Hz signal is detected, the no clock EOL state will be reset and a ST (self-test) cycle will occur after 75 ms. If this ST cycle passes, the next ST cycle will occur in 12 minutes. If four consecutive no clock ST cycles fail, a ST EOL fault will occur. During a no clock EOL state, the phase information will be detected by the shunt regulator’s bias circuitry. The shunt regulator will detect an AC zero cross by monitoring the Shunt regulator’s clamp current. When the VAC voltage crosses ~80 volts, a zero cross is registered by the shunt regulator’s circuitry.

Note, the “no clock” EOL logic can be used in production testing for generation of an EOL state and enabling the LED indicator. If a DC voltage greater than ~75 volts is applied to the Line Hot input, the NCS37020 will be biased correctly but will not see a zero cross signal and a “no clock” ST EOL failure will occur. The LED will be enabled within 150 ms.

The first self-test (ST) cycle will occur at one second and thereafter every 12 minutes. During the ST cycle, the Fault Test pin will be enabled during the positive half cycle and the CT current (set at 12 mA, R8) will be verified. During the next negative half cycle, the SCR’s anode voltage will be pre-biased by the SCR Test pin to 3.3 volts. The SCR will then be enabled and the SCR’s anode voltage will be monitored by the SCR Test pin. If the anode voltage goes below 2.1 volts, the SCR will be disabled after a 400 μs verification check and the ST logic will register a passing ST cycle. Figure 2 shows two SCRs in series. A redundant SCR is required during the SCR anode to cathode short test to prevent the solenoid from burn out damage. The SCR self-test cycle will fail if either SCR Q1A or Q1B are open. If either Q1A or Q1B are shorted (anode to cathode) the ST cycle will pass, however, the GF function will also function correctly. The next ST cycle will occur in 12 minutes. Note that when the SCR is enabled, the blocking diode D5 will prevent the solenoid from being energized and opening the load contacts. If either the GF (ground fault) or SCR self-test cycles fail, these self-test cycles will be repeated for up to three more consecutive cycles. If any consecutive GF and SCR tests pass, the ST logic will register a passing self-test cycle. If all four ST consecutive cycles fail, a ST cycle will be repeated at 2, 3 and 4 seconds for a total of 16 self-test cycles. If all 16 ST cycles fail, a ST EOL fault will occur. The SCR will be enabled for four consecutive positive half cycles, then the LED will blink at 4 Hz. The LED will only be biased during the positive AC half wave cycle. The SCR will be enabled for one positive half cycle every 4.5 seconds. A self-test cycle will occur every second. If a self-test cycle passes, the ST EOL logic will be reset (power on reset state). If a ground fault is detected during a ST EOL state, the EOL logic will be reset. This allows for resetting the ST EOL state by pressing the manual test button when the load contacts are closed.

The above no clock and GF/SCR self-test functions provide for full UL943B (3rd Edition) compliance for the auto monitoring requirement. The NCS37020 IC controller tests for the CT, solenoid, clock input, SCR and bias circuitry.

The CT is biased at 1.65 volts. The CT sense amplifier monitors the ground fault current. This current is converted to a voltage level at the CTO pin which is the input to the ADC (IDF pin). The resistor R5 sets the GF threshold per the following equation:

$$I_{diff} = \frac{0.203 \times CT_1 \times (R_{CT1} + R_7 + 2\pi f_{AC} L_{CT1})}{R_5 \times (R_{CT1} + 2\pi f_{AC} L_{CT1})} \quad (\text{eq. 1})$$

CT₁ = Turns ratio of differential CT

R_{CT1} = DC winding resistance of differential CT

f_{AC} = AC mains frequency

L_{CT1} = Inductance of differential CT

The ground fault detection circuit has different levels of time delay before the SCR is enabled:

6 mA to 15 mA	≤150 ms
15 mA to 30 mA	≤100 ms
30 mA to 100 mA	≤50 ms
>100 mA	≤25 ms

If a very high GF occurs and a greater than 250 mV signal occurs across the CT for greater than 1.4 ms, the saturation fault comparator will enable the SCR during the positive half cycle.

During a self-test, the GF detection circuit is active. However, for the 6 mA to 15 mA GF range, an additional ~100ms trip delay will be added before the SCR is enabled.

Note that the above equation is for an ideal CT. In practice, the GF threshold can be ±30% different and should be empirically set.

The internal oscillator is trimmed to 2 MHz when the AC frequency is 60 Hz. If the AC frequency is lower, the GF trip threshold response time will be slower.

The CT sense amplifier has an internal dynamic V_{OS} cancelation circuit which allows for direct coupling to the CT transformer.

The TE pin is used for internal production testing only. This pin should be connected to the GND pin.

Contact ON Semiconductor for self-test requirement details and noise filtering recommendations.

Figure Description

Figure 3 shows the typical SCR enable delay time versus the GF current level. Shown is a typical 85 ms delay time for a 6 mA GF. The typical delay time for a 25 mA GF is 28 ms and 14 ms for a 500 Ω 240 mA GF.

Figure 4 shows a passing self-test ground fault test. This test checks for the CT and bias circuitry. Channel 1 shows the VAC 120 V_{RMS} , 60 Hz Line Voltage. Channel 2 shows the positive and negative phase half wave cycles. Channel 3 shows the Fault Test signal and channel 4 shows the IDF signal (CTO output). The self-test cycle starts in the positive half wave cycle. The Fault Test pin goes high and Q2 (Figure 2) is enabled. Enabling Q2 generates a GF signal via R8. The IDF signal is the CTO amplifier output which is a GF current to voltage signal per the equation on the previous page. When a 5 to 15 mA GF signal is detected, a “passing GF test” is recorded and the Fault Test signal is disabled.

Figure 5 shows a passing self-test SCR test. This test checks for the SCR and bias circuitry. Channel 1 shows the VAC 120 V_{RMS} , 60 Hz Line Voltage. Channel 2 shows the positive and negative phase half wave cycles. Channel 3 shows the SCR signal and channel 4 shows the SCR Test signal. At the end of the positive half cycle, the SCR Test pin is biased high. Approximately 3 ms into the negative half wave cycle, the SCR is enabled high. This causes the SCR Test pin to go low. When it goes below ~2.1 volts, a passing SCR test is recorded and the SCR signal is disabled.

After a passing self-test cycle per Figures 4 and 5, the next ST cycle will occur in 720 seconds.

Figure 6 shows a failing ST cycle for an open CT. Channel 1 shows the NCS37020 supply voltage. Channel 2 shows the phase pin. Channel 3 shows the Fault Test signal and channel 4 shows the LED (End of Life) signal. The first four consecutive ST cycles occur at about 1.1 seconds, then at 2.2, 3.3 and 4.4 seconds. After the 16th consecutive cycle failure, the SCR is enabled for four positive half cycles and then the LED is enabled.

Figure 7 also shows a failing ST cycle for an open CT. It is a zoom figure for the first four consecutive ST cycles. It shows the same waveforms as Figure 6 but channel 4 shows the SCR pin. Comparing Figure 7 with Figure 4, it can be observed that the Fault Test pin is enabled for the complete positive half wave cycle because no GF signal is detected by the NCS37020.

Figure 8 shows a failing ST cycle for an open SCR. Channel 1 shows the supply voltage, channel 2 shows the Phase pin, channel 3 shows the SCR pin and channel 4 shows the SCR Test pin. The SCR is enabled inside the negative half wave cycle. The SCR Test pin does not detect the SCR going low so the cycle is recorded as a SCR failure test.

Figure 9 shows a failing “no clock” test. The Phase pin is floating for this test. Channel 1 shows the supply voltage, channel 2 shows the Phase pin and channel 3 shows the LED pin. No signal is present on the Phase pin after POR. At ~114 ms, the LED End of Life signal is enabled during the positive half wave cycle. The LED EOL signal blinks at 4 Hz.

Figure 10 also shows a failing “no clock” test. This figure is the same as Figure 9 except for the time scale and the SCR signal is added (channel 4). The first SCR pulse occurs at ~3.8 seconds.

NCS37020

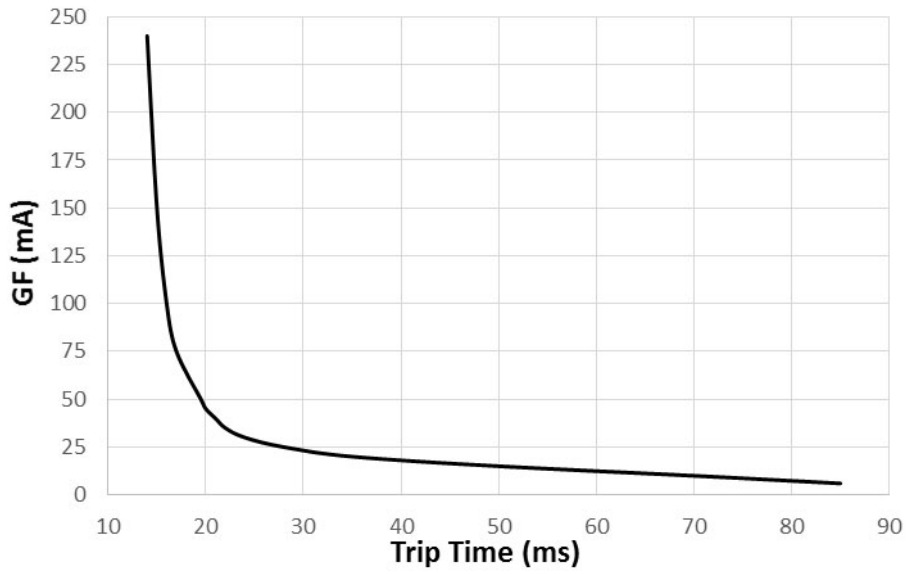

Figure 3. Typical GF Current vs. Trip Time

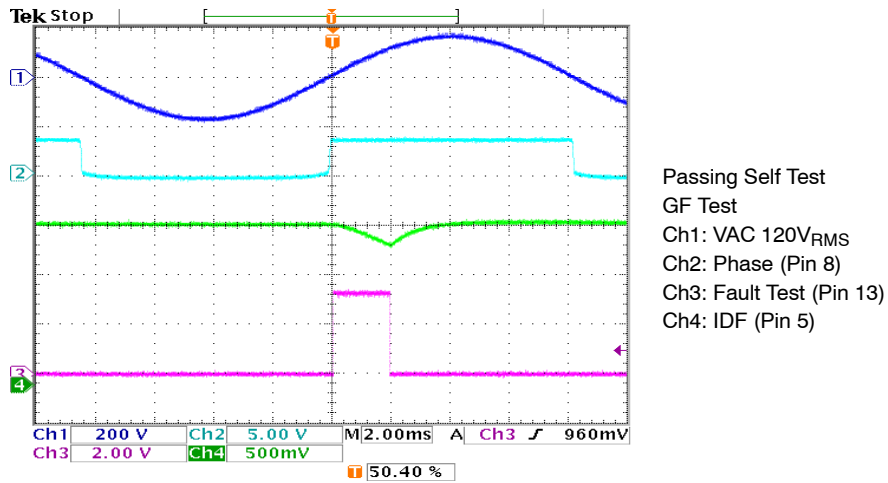

Figure 4. Passing Self Test – GF

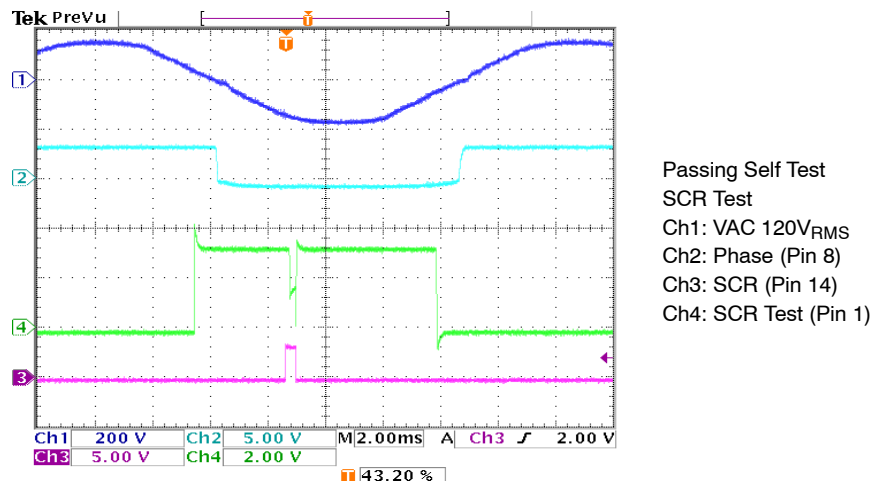

Figure 5. Passing Self Test – SCR

NCS37020

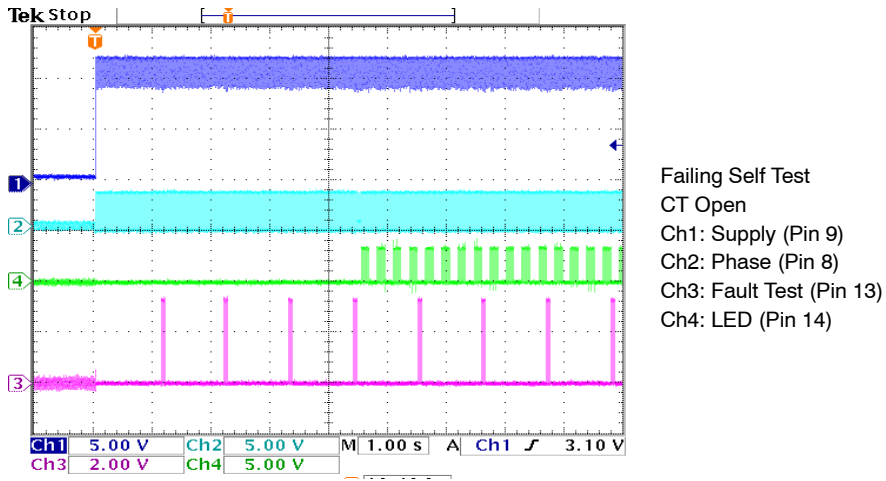

Figure 6. Failing Self Test – CT Open

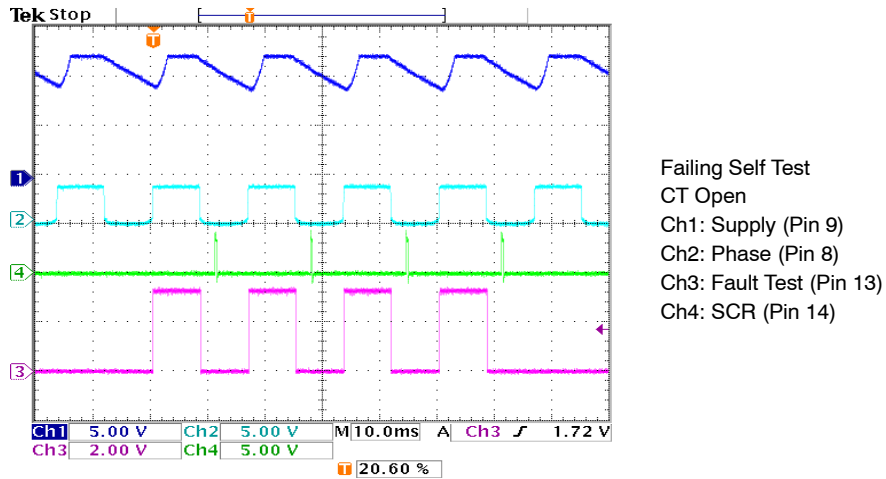

Figure 7. Failing Self Test – CT Open

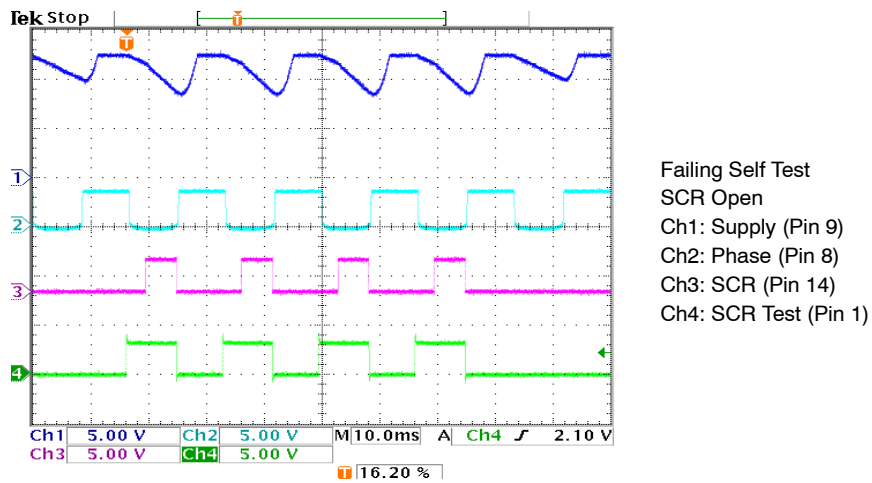

Figure 8. Failing Self Test – SCR Open

NCS37020

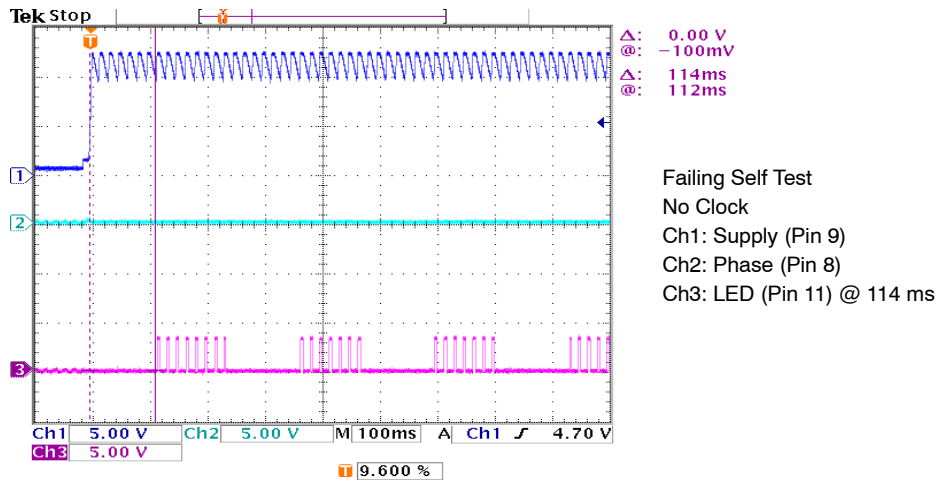

Figure 9. Failing Self Test – No Clock

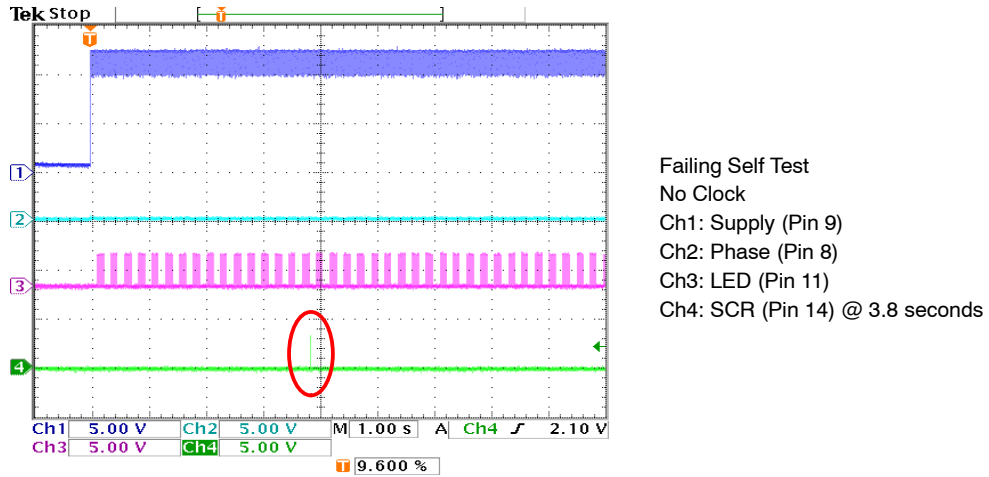
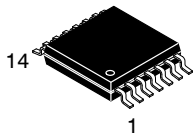

Figure 10. Failing Self Test – No Clock

MECHANICAL CASE OUTLINE PACKAGE DIMENSIONS

ON Semiconductor®



TSSOP-14 WB
CASE 948G
ISSUE C

DATE 17 FEB 2016

SCALE 2:1



NOTES:

- DIMENSIONING AND TOLERANCING PER ANSI Y14.5M, 1982.
- CONTROLLING DIMENSION: MILLIMETER.
- DIMENSION A DOES NOT INCLUDE MOLD FLASH, PROTRUSIONS OR GATE BURRS. MOLD FLASH OR GATE BURRS SHALL NOT EXCEED 0.15 (0.006) PER SIDE.
- DIMENSION B DOES NOT INCLUDE INTERLEAD FLASH OR PROTRUSION. INTERLEAD FLASH OR PROTRUSION SHALL NOT EXCEED 0.25 (0.010) PER SIDE.
- DIMENSION K DOES NOT INCLUDE DAMBAR PROTRUSION. ALLOWABLE DAMBAR PROTRUSION SHALL BE 0.08 (0.003) TOTAL IN EXCESS OF THE K DIMENSION AT MAXIMUM MATERIAL CONDITION.
- TERMINAL NUMBERS ARE SHOWN FOR REFERENCE ONLY.
- DIMENSION A AND B ARE TO BE DETERMINED AT DATUM PLANE -W-.

DIM	MILLIMETERS		INCHES	
	MIN	MAX	MIN	MAX
A	4.90	5.10	0.193	0.200
B	4.30	4.50	0.169	0.177
C	---	1.20	---	0.047
D	0.05	0.15	0.002	0.006
F	0.50	0.75	0.020	0.030
G	0.65 BSC		0.026 BSC	
H	0.50	0.60	0.020	0.024
J	0.09	0.20	0.004	0.008
J1	0.09	0.16	0.004	0.006
K	0.19	0.30	0.007	0.012
K1	0.19	0.25	0.007	0.010
L	6.40 BSC		0.252 BSC	
M	0°	8°	0°	8°

GENERIC MARKING DIAGRAM*

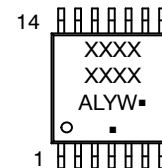

- A = Assembly Location
- L = Wafer Lot
- Y = Year
- W = Work Week
- = Pb-Free Package

(Note: Microdot may be in either location)

*This information is generic. Please refer to device data sheet for actual part marking. Pb-Free indicator, "G" or microdot "▪", may or may not be present.

SOLDERING FOOTPRINT

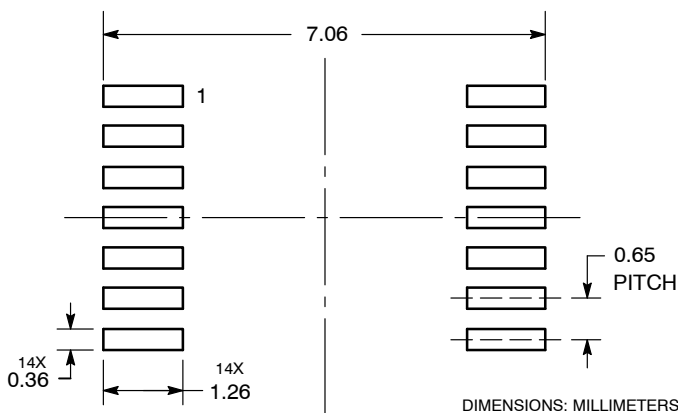

DOCUMENT NUMBER:	98ASH70246A	Electronic versions are uncontrolled except when accessed directly from the Document Repository. Printed versions are uncontrolled except when stamped "CONTROLLED COPY" in red.
DESCRIPTION:	TSSOP-14 WB	PAGE 1 OF 1

ON Semiconductor and ON are trademarks of Semiconductor Components Industries, LLC dba ON Semiconductor or its subsidiaries in the United States and/or other countries. ON Semiconductor reserves the right to make changes without further notice to any products herein. ON Semiconductor makes no warranty, representation or guarantee regarding the suitability of its products for any particular purpose, nor does ON Semiconductor assume any liability arising out of the application or use of any product or circuit, and specifically disclaims any and all liability, including without limitation special, consequential or incidental damages. ON Semiconductor does not convey any license under its patent rights nor the rights of others.

onsemi, **Onsemi**, and other names, marks, and brands are registered and/or common law trademarks of Semiconductor Components Industries, LLC dba "**onsemi**" or its affiliates and/or subsidiaries in the United States and/or other countries. **onsemi** owns the rights to a number of patents, trademarks, copyrights, trade secrets, and other intellectual property. A listing of **onsemi**'s product/patent coverage may be accessed at www.onsemi.com/site/pdf/Patent-Marking.pdf. **onsemi** reserves the right to make changes at any time to any products or information herein, without notice. The information herein is provided "as-is" and **onsemi** makes no warranty, representation or guarantee regarding the accuracy of the information, product features, availability, functionality, or suitability of its products for any particular purpose, nor does **onsemi** assume any liability arising out of the application or use of any product or circuit, and specifically disclaims any and all liability, including without limitation special, consequential or incidental damages. Buyer is responsible for its products and applications using **onsemi** products, including compliance with all laws, regulations and safety requirements or standards, regardless of any support or applications information provided by **onsemi**. "Typical" parameters which may be provided in **onsemi** data sheets and/or specifications can and do vary in different applications and actual performance may vary over time. All operating parameters, including "Typicals" must be validated for each customer application by customer's technical experts. **onsemi** does not convey any license under any of its intellectual property rights nor the rights of others. **onsemi** products are not designed, intended, or authorized for use as a critical component in life support systems or any FDA Class 3 medical devices or medical devices with a same or similar classification in a foreign jurisdiction or any devices intended for implantation in the human body. Should Buyer purchase or use **onsemi** products for any such unintended or unauthorized application, Buyer shall indemnify and hold **onsemi** and its officers, employees, subsidiaries, affiliates, and distributors harmless against all claims, costs, damages, and expenses, and reasonable attorney fees arising out of, directly or indirectly, any claim of personal injury or death associated with such unintended or unauthorized use, even if such claim alleges that **onsemi** was negligent regarding the design or manufacture of the part. **onsemi** is an Equal Opportunity/Affirmative Action Employer. This literature is subject to all applicable copyright laws and is not for resale in any manner.

PUBLICATION ORDERING INFORMATION

LITERATURE FULFILLMENT:

Email Requests to: orderlit@onsemi.com

onsemi Website: www.onsemi.com

TECHNICAL SUPPORT

North American Technical Support:

Voice Mail: 1 800-282-9855 Toll Free USA/Canada

Phone: 011 421 33 790 2910

Europe, Middle East and Africa Technical Support:

Phone: 00421 33 790 2910

For additional information, please contact your local Sales Representative