

NCP693

1A CMOS Low-Dropout Voltage Regulator

The NCP693 series of fixed output low dropout linear regulators are designed for portable battery powered applications with high output current requirement up to 1 A. Each device contains a voltage reference unit, an error amplifier, a PMOS power transistor, resistors for setting output voltage, a current limit circuits for over-current and thermal-shutdown. A standby mode with ultra low supply current can be realized with the chip enable function.

The device is housed in the DFN 1.8x2, 0.50P surface mount package. Standard voltage versions are 0.8 V, 1.0 V, 1.2 V, 2.5 V and 3.3 V.

Features

- Maximum Operating Voltage of 6.5 V
- Low Output Voltage Option down to 0.8 V
- High Accuracy Output Voltage of 1.0%
- Built-in Auto Discharge Function for D Version
- These are Pb-Free Devices

Typical Applications

- Battery Powered Instruments
- Hand-Held Instruments
- Camcorders and Cameras
- Portable communication equipments



ON Semiconductor®

<http://onsemi.com>

MARKING DIAGRAM

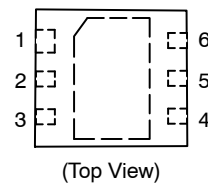
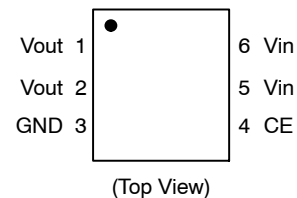


UDFN6, 1.8x2, 0.5P
CASE 517BA



XXXX = Specific Device Code
MM = Lot Number

PIN DESCRIPTION



ORDERING AND MARKING INFORMATION

See detailed ordering and shipping information in the package dimensions section on page 11 of this data sheet.

NCP693

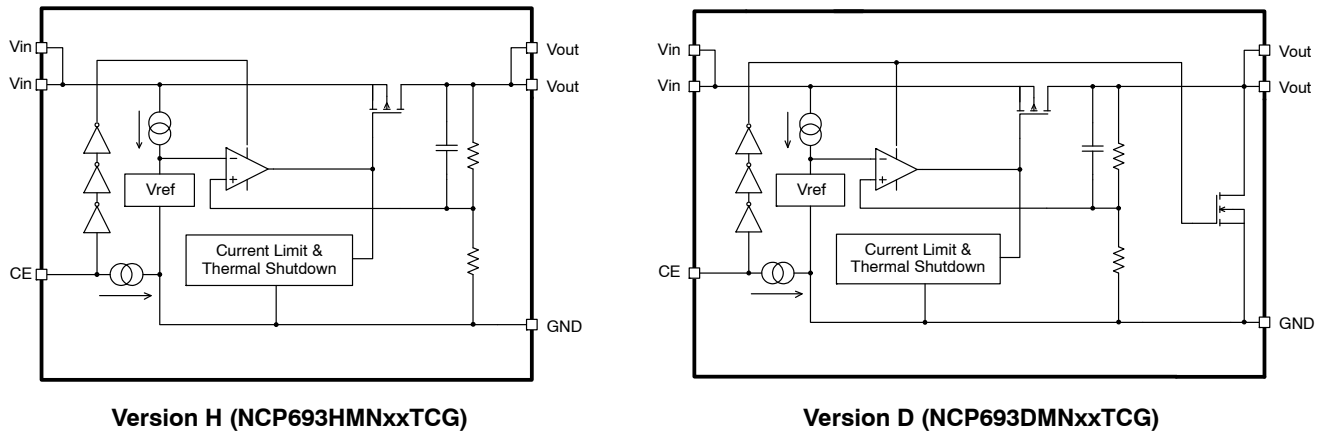


Figure 1. Internal Block Diagram

PIN FUNCTION DESCRIPTION

Pin No.	Pin Name	Description
1	V_{out}	Regulated output voltage.
2	V_{out}	Regulated output voltage.
3	GND	Power supply ground.
4	CE	This input is used to place the device into low-power standby. When this input is pulled low, the device is disabled. If this function is not used, Enable should be connected to V_{in} .
5	V_{in}	Positive power supply input voltage.
6	V_{in}	Positive power supply input voltage.
EP	GND	Power supply ground.

MAXIMUM RATINGS

Rating	Symbol	Value	Unit
Input Voltage	V_{in}	7	V
Enable Voltage	V_{CE}	-0.3 to V_{in}	V
Output Voltage	V_{out}	-0.3 to $V_{in} + 0.3$	V
Operating Junction Temperature	T_J	+150	°C
Operating Ambient Temperature	T_A	-40 to +85	°C
Storage Temperature	T_{stg}	-55 to +125	°C

Stresses exceeding Maximum Ratings may damage the device. Maximum Ratings are stress ratings only. Functional operation above the Recommended Operating Conditions is not implied. Extended exposure to stresses above the Recommended Operating Conditions may affect device reliability.

- This device series contains ESD protection and exceeds the following tests:
 Human Body Model 2000 V per (JEDEC 22-A114-B)
 Machine Model Method 200 V

THERMAL CHARACTERISTICS

Rating	Symbol	Test Conditions	Typical Value	Unit
Junction-to-Ambient	$R_{\theta JA}$	1 oz Copper Thickness, 100 mm ²	114	°C/W
PSIJ-Lead 2	Ψ_{J-L2}	1 oz Copper Thickness, 100 mm ²	25	°C/W
Power Dissipation	P_D		880	mW

NOTE: Single component mounted on an 80 x 80 x 1.5 mm FR4 PCB with stated copper head spreading area. Using the following boundary conditions as stated in EIA/JESD 51-1, 2, 3, 7, 12.

NCP693

ELECTRICAL CHARACTERISTICS ($V_{in} = V_{out(nom)} + 1.0\text{ V}$, $V_{CE} = V_{in}$, $C_{in} = 2.2\ \mu\text{F}$, $C_{out} = 2.2\ \mu\text{F}$, $T_A = 25^\circ\text{C}$, unless otherwise noted)

Characteristic	Symbol	Min	Typ	Max	Unit
Output Voltage ($T_A = 25^\circ\text{C}$, $I_{out} = 10\text{ mA}$) 0.8 V 1.0 V 1.2 V 2.5 V 3.3 V	V_{out}	0.785 0.985 1.185 2.475 3.267	0.8 1.0 1.2 2.5 3.3	0.815 1.015 1.215 2.525 3.333	V
Output Voltage ($T_A = -40^\circ\text{C}$ to 85°C , $I_{out} = 10\text{ mA}$) 0.8 V 1.0 V 1.2 V 2.5 V 3.3 V	V_{out}	0.760 0.960 1.160 2.435 3.214	0.8 1.0 1.2 2.5 3.3	0.827 1.027 1.227 2.545 3.359	V
Output Current	I_{out}		1		A
Input Voltage	V_{in}	1.6		6.5	V
Line Regulation ($V_{in} = V_{out} + 1.0\text{ V}$ to 6.5 V , $I_{out} = 10\text{ mA}$)	Reg_{line}	–	0.05	0.1	%/V
Load Regulation ($I_{out} = 1\text{ mA}$ to 300 mA , $V_{in} = V_{out} + 2.0\text{ V}$)	Reg_{load03}	–	20	40	mV
Load Regulation ($I_{out} = 1\text{ mA}$ to 1 A , $V_{in} = V_{out} + 2.0\text{ V}$)	Reg_{load1}	–	80	120	mV
Supply Current ($I_{out} = 0\text{ A}$, $V_{in} = 6.5\text{ V}$)	I_{ss}		65	90	μA
Standby Current ($V_{CE} = 0\text{ V}$, $V_{in} = 6.5\text{ V}$)	I_{stby}		0.15	0.6	μA
Short Current Limit ($V_{out} = 0\text{ V}$)	I_{sh}		250		mA
Output Voltage Temperature Coefficient	T_c	–	± 100	–	ppm/ $^\circ\text{C}$
Enable Input Threshold Voltage (Voltage Increasing, Output Turns On, Logic High) (Voltage Decreasing, Output Turns Off, Logic Low)	V_{thCE}	1.0 –	– –	– 0.4	V
Enable Pulldown Current			0.3		μA
Drop Output Voltage ($T_A = 25^\circ\text{C}$, $I_{out} = 300\text{ mA}$) 0.8 V 1.0 V 1.2 V 2.5 V 3.3 V	$V_{in}-V_{out}$		0.670 0.450 0.300 0.150 0.130	0.780 0.610 0.500 0.310 0.170	V
Drop Output Voltage ($T_A = 25^\circ\text{C}$, $I_{out} = 1\text{ A}$) 0.8 V 1.0 V 1.2 V 2.5 V 3.3 V	$V_{in}-V_{out}$		1.150 1.000 0.870 0.500 0.430	1.650 1.450 1.380 1.100 0.650	V
Ripple Rejection (Ripple 200 mV_{pp} , $I_{out} = 100\text{ mA}$, $f = 1\text{ kHz}$)	PSRR		70		dB
Output Noise (BW = 10 Hz to 100 kHz , $I_{out} = 1\text{ mA}$)	V_{noise}		45		μV_{rms}
Thermal Shutdown Temperature/Hysteresis	$T_{shd}/Hyst$		165/30		$^\circ\text{C}$
$R_{DS(on)}$ of additional output transistor (D version only)	$R_{DS(on)}$		30		Ω

2. Maximum package power dissipation limits must be observed.
3. Low duty cycle pulse techniques are used during testing to maintain the junction temperature as close to ambient as possible.

NCP693

APPLICATIONS INFORMATION

A typical application circuit for the NCP693 series is shown in Figure 2.

Input Decoupling (C1)

A 2.2 μF capacitor either ceramic or tantalum is recommended and should be connected as close as possible to the pins of NCP693 device. Higher values and lower ESR will improve the overall line transient response.

Output Decoupling (C2)

The minimum decoupling value is 2.2 μF and can be augmented to fulfill stringent load transient requirements. The regulator accepts ceramic chip capacitors as well as tantalum devices. If a tantalum capacitor is used, and its ESR is large, the loop oscillation may result. Because of this, select C2 carefully considering its frequency characteristics. Larger values improve noise rejection and load regulation transient response.

Enable Operation

The enable pin CE will turn on or off the regulator. These limits of threshold are covered in the electrical specification section of this data sheet. If the enable is not used then the pin should be connected to V_{in} . The D version devices

(NCP693DMNxxTCG) have additional circuitry in order to reach the turn-off speed faster than normal type. When the mode is into standby with CE signal, auto discharge transistor turns on.

Hints

Please be sure the V_{in} and GND lines are sufficiently wide. If their impedance is high, noise pickup or unstable operation may result.

Set external components, especially the output capacitor, as close as possible to the circuit, and make leads as short as possible.

Thermal

As power across the NCP693 increases, it might become necessary to provide some thermal relief. The maximum power dissipation supported by the device is dependent upon board design and layout. Mounting pad configuration on the PCB, the board material, and also the ambient temperature effect the rate of temperature rise for the part. This is stating that when the NCP693 has good thermal conductivity through the PCB, the junction temperature will be relatively low with high power dissipation applications.

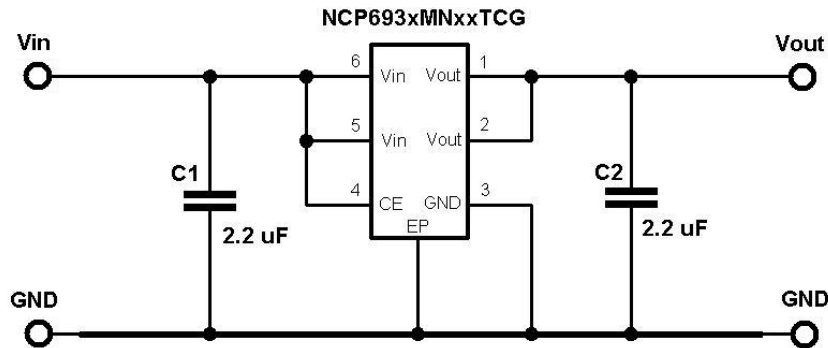
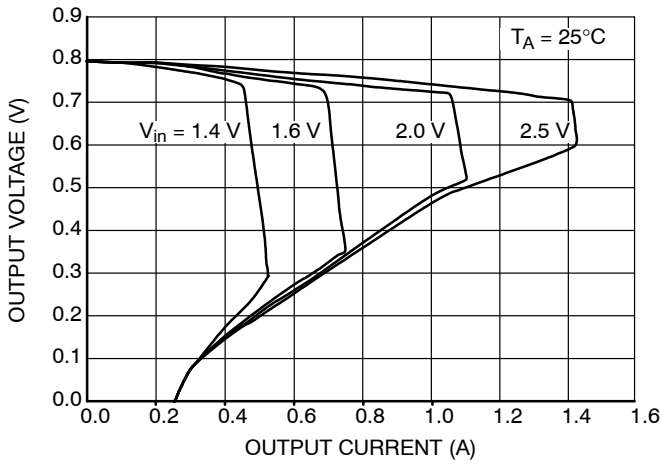
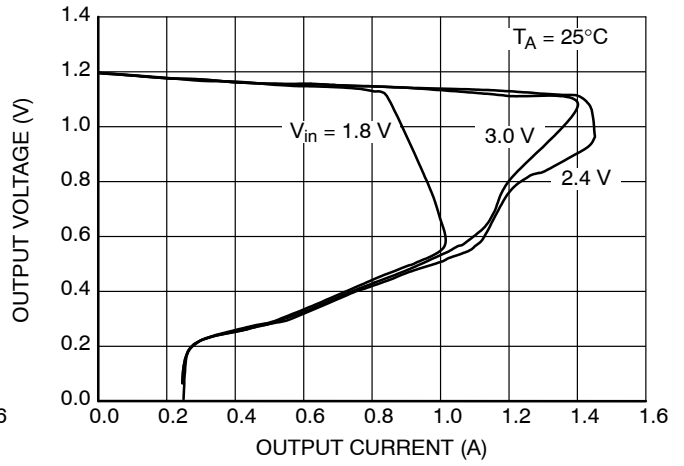


Figure 2. Typical Application Circuit

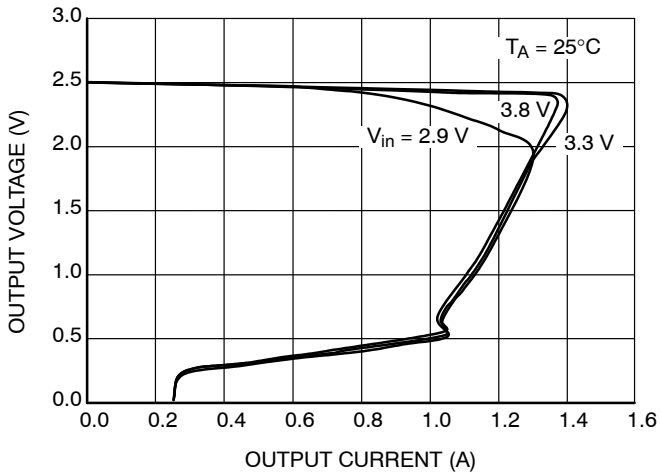
NCP693



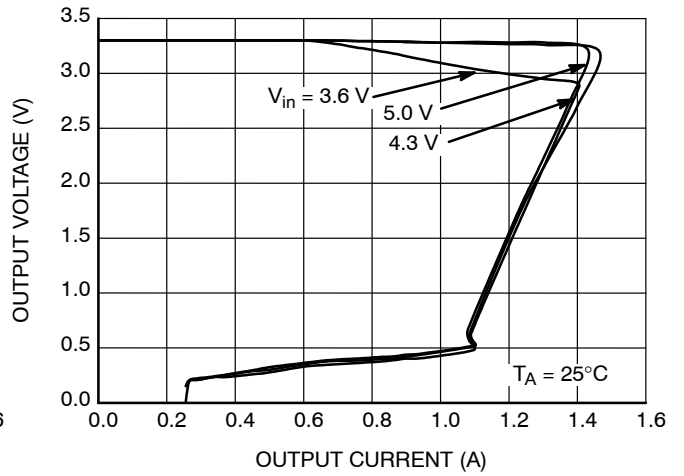
**Figure 3. Output Voltage vs. Output Current
NCP693xMN08TCG**



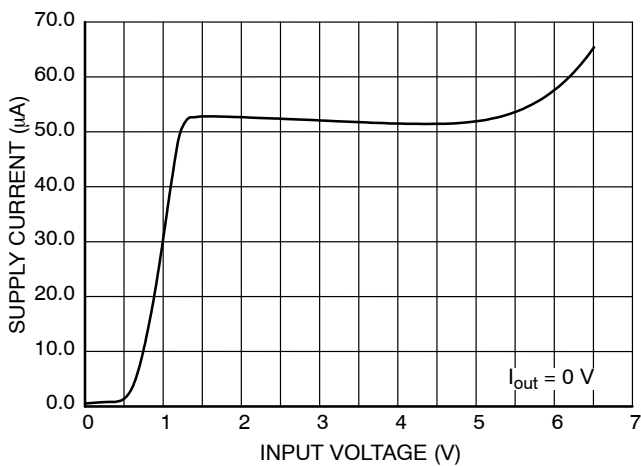
**Figure 4. Output Voltage vs. Output Current
NCP693xMN12TCG**



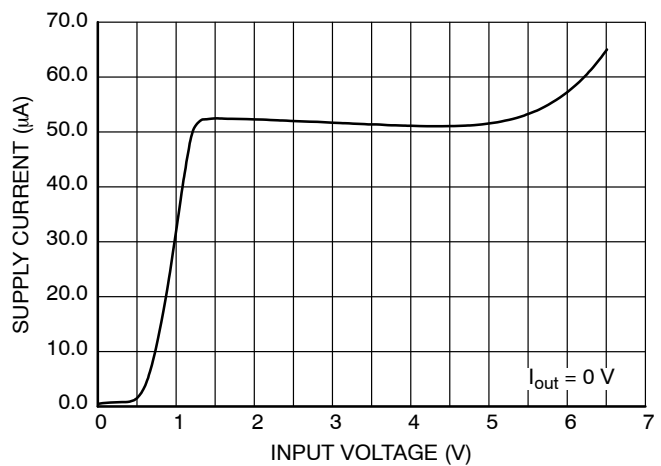
**Figure 5. Output Voltage vs. Output Current
NCP693xMN25TCG**



**Figure 6. Output Voltage vs. Output Current
NCP693xMN33TCG**

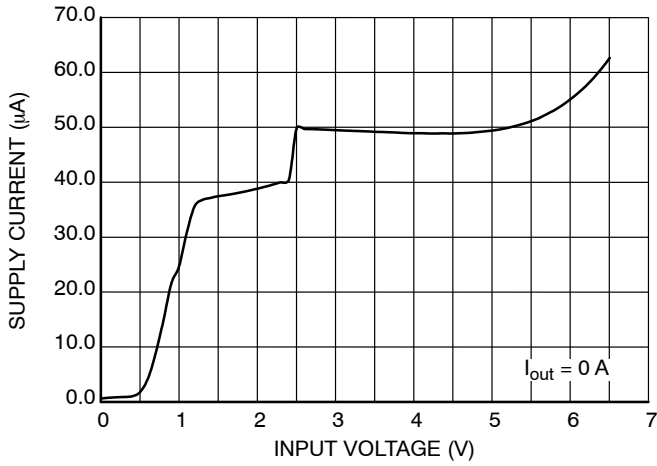


**Figure 7. Supply Current vs. Input Voltage
NCP693xMN08TCG**

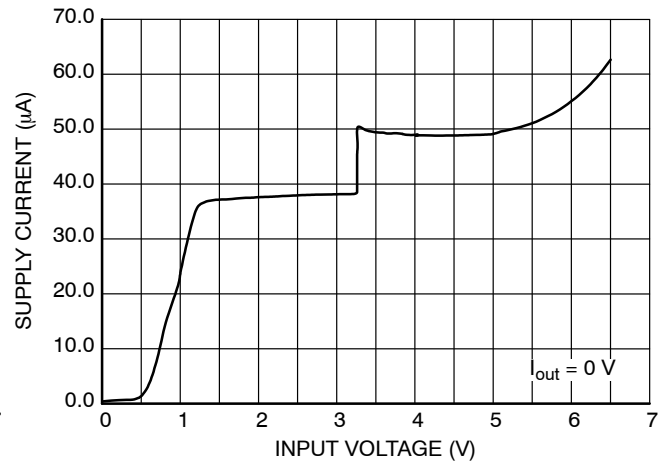


**Figure 8. Supply Current vs. Input Voltage
NCP693xMN12TCG**

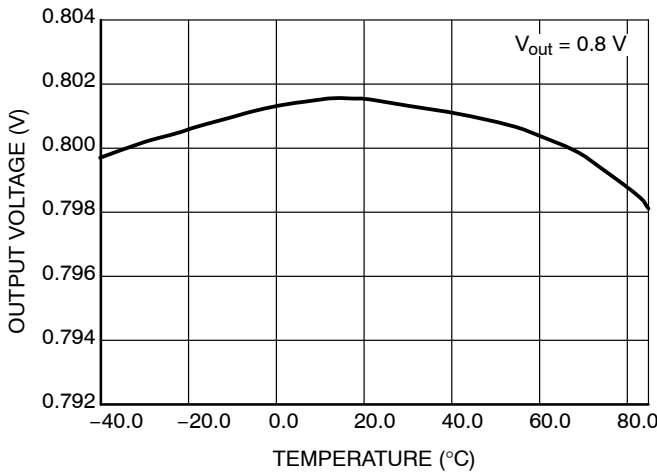
NCP693



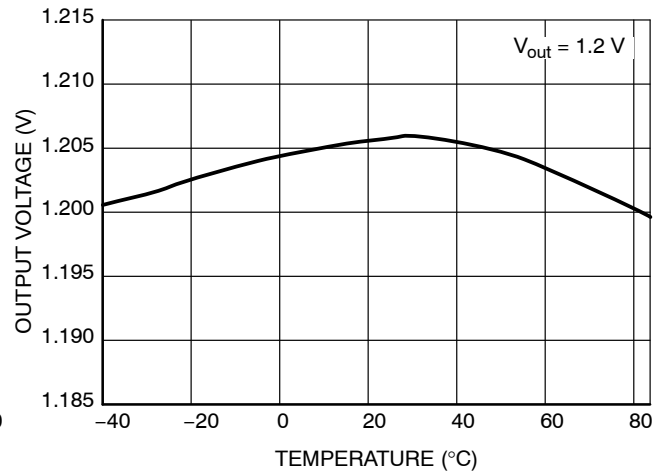
**Figure 9. Supply Current vs. Input Voltage
NCP693xMN25TCG**



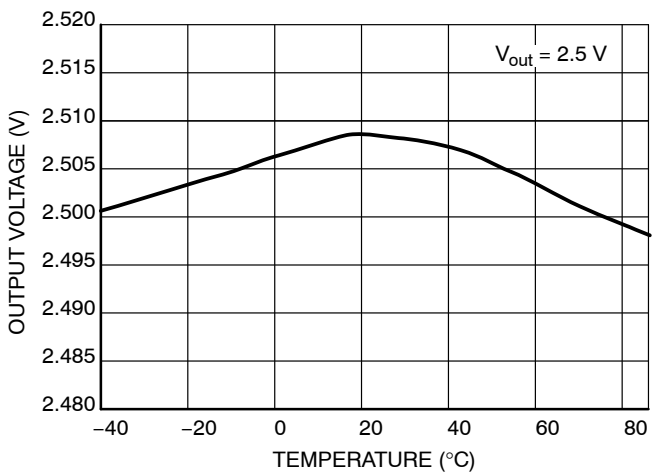
**Figure 10. Supply Current vs. Input Voltage
NCP693xMN33TCG**



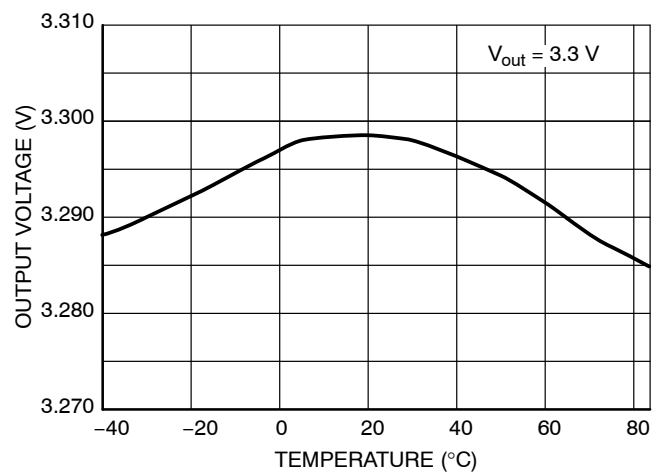
**Figure 11. Output Voltage vs. Temperature
NCP693xMN08TCG**



**Figure 12. Output Voltage vs. Temperature
NCP693xMN12TCG**

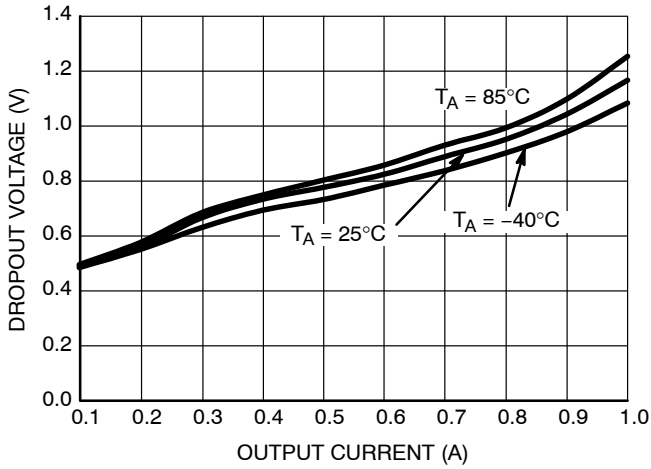


**Figure 13. Output Voltage vs. Temperature
NCP693xMN25TCG**

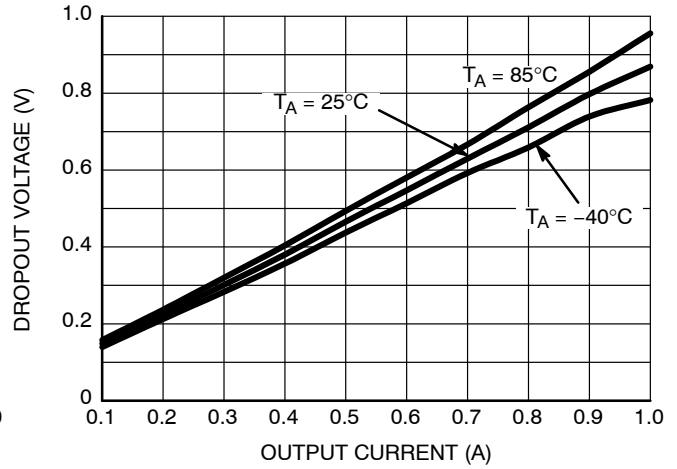


**Figure 14. Output Voltage vs. Temperature
NCP693xMN33TCG**

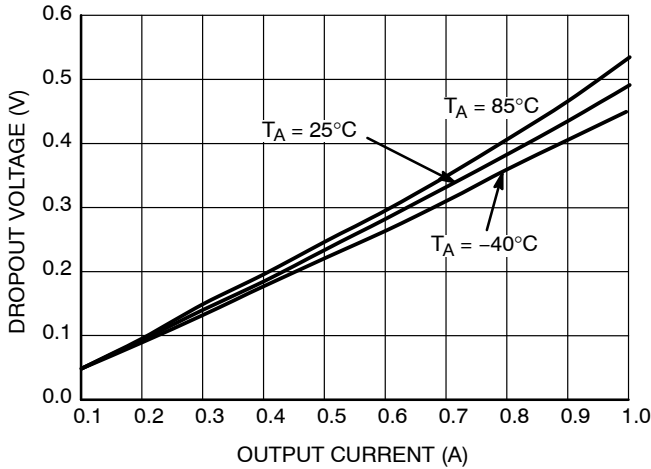
NCP693



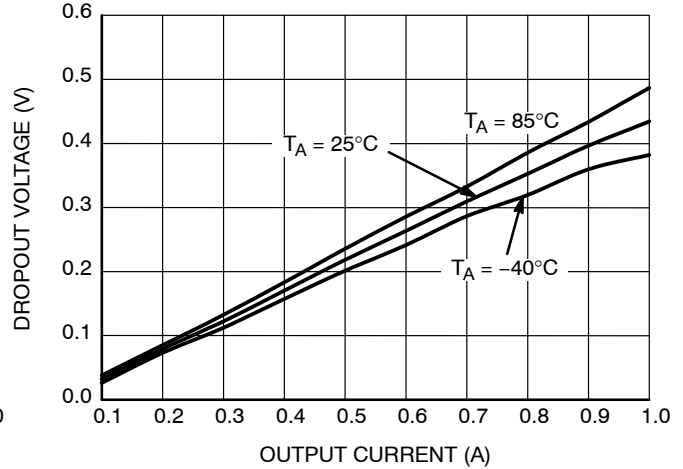
**Figure 15. Dropout Voltage vs. Output Current
NCP693xMN08TCG**



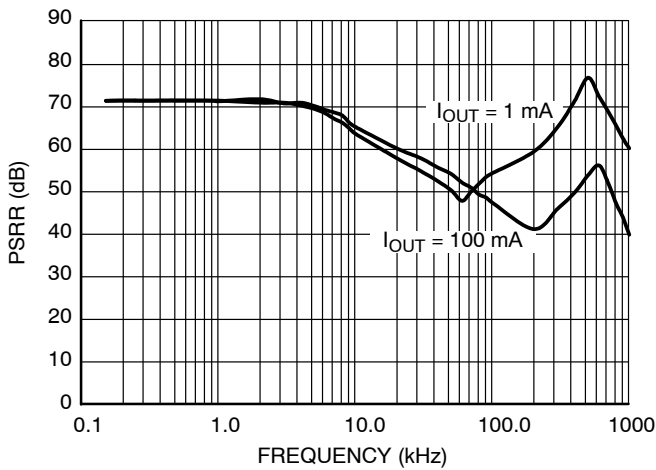
**Figure 16. Dropout Voltage vs. Output Current
NCP693xMN12TCG**



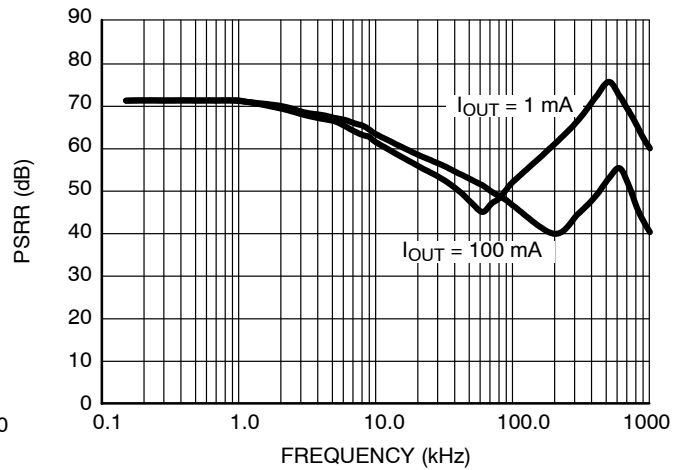
**Figure 17. Dropout Voltage vs. Output Current
NCP693xMN25TCG**



**Figure 18. Dropout Voltage vs. Output Current
NCP693xMN33TCG**



**Figure 19. PSRR vs. Frequency
NCP693xMN08TCG**



**Figure 20. PSRR vs. Frequency
NCP693xMN12TCG**

NCP693

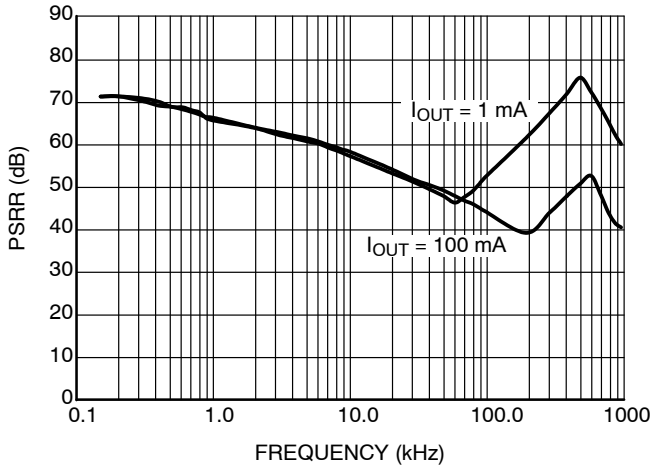


Figure 21. PSRR vs. Frequency
NCP693xMN25TCG

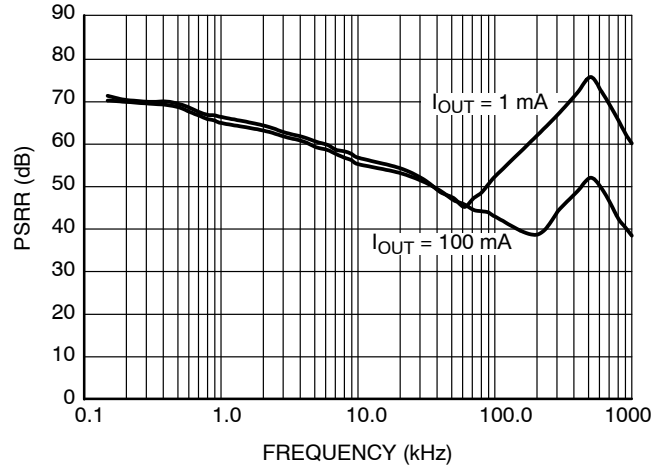


Figure 22. PSRR vs. Frequency
NCP693xMN33TCG

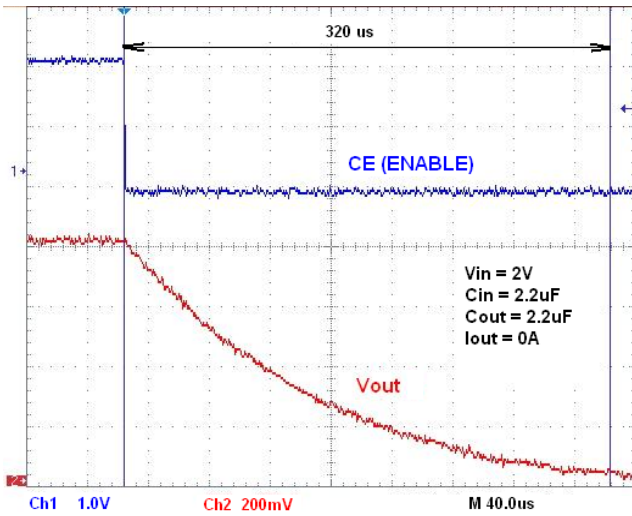


Figure 23. Turn Off Speed NCP693DMN08TCG

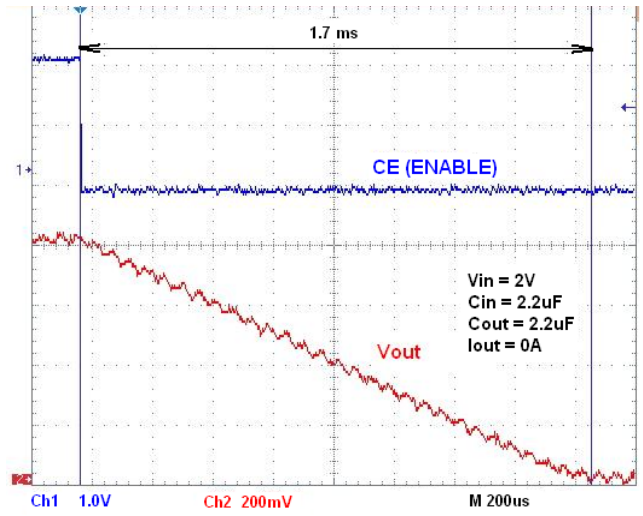


Figure 24. Turn Off Speed NCP693HMN08TCG

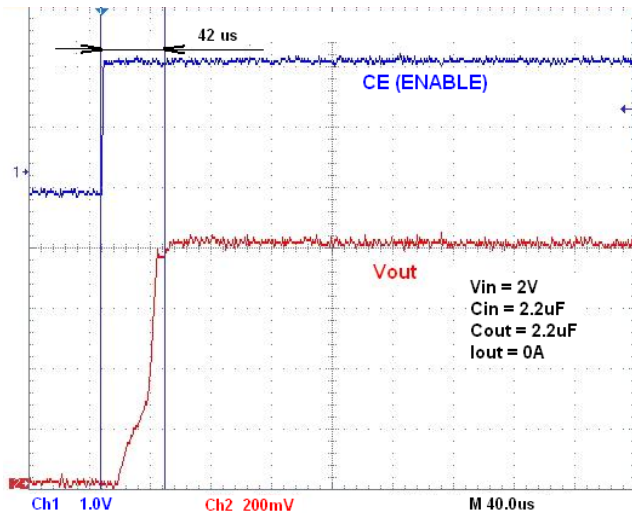


Figure 25. Turn On Speed NCP693xMN08CTG

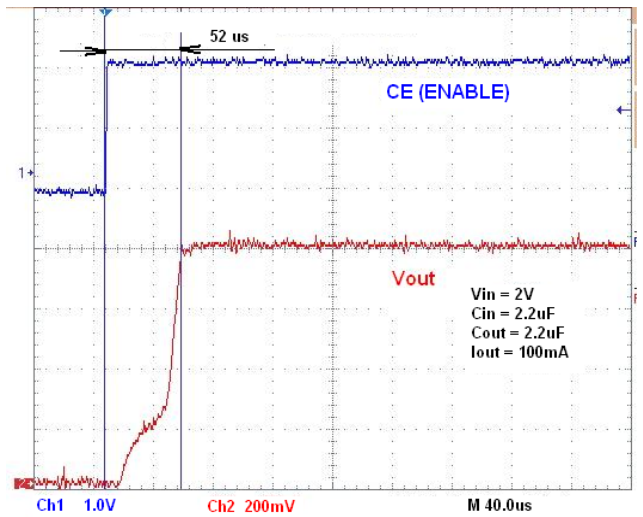


Figure 26. Turn On Speed NCP693xMN08CTG

NCP693

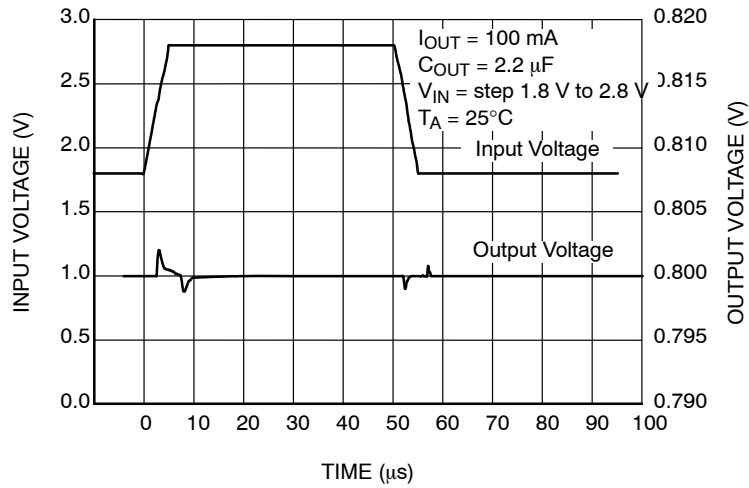


Figure 27. Input Response NCP693xMN08TCG

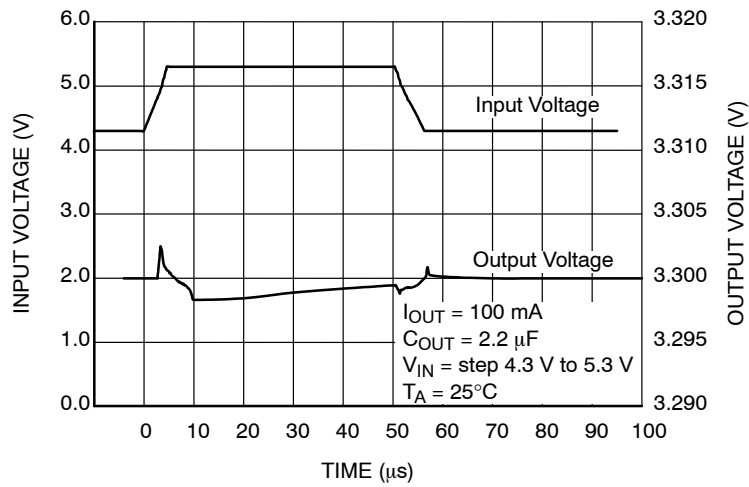


Figure 28. Input Response NCP693xMN33TCG

NCP693

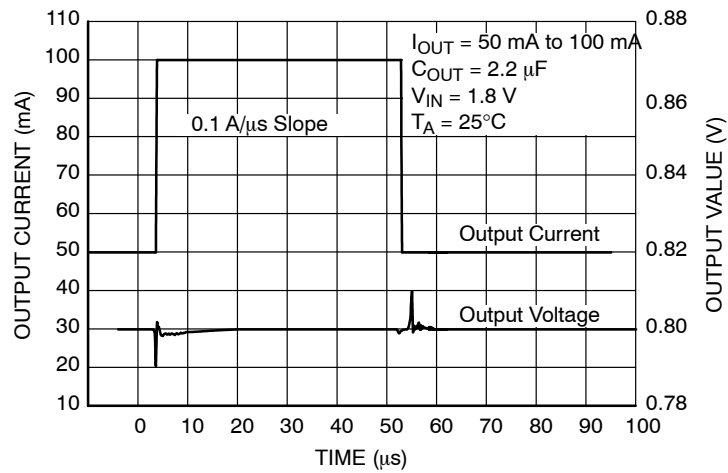


Figure 29. Input Response NCP693xMN08TCG

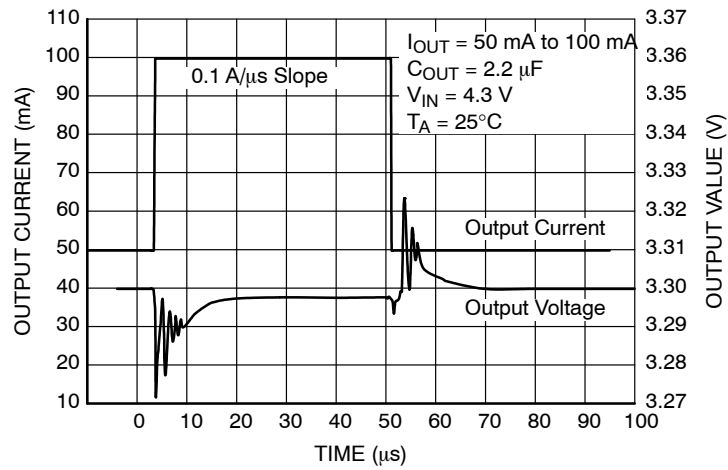


Figure 30. Input Response NCP693xMN33TCG

NCP693

ORDERING INFORMATION

Device	Nominal Output Voltage	Marking	Package	Shipping [†]
NCP693HMN08TCG	0.8	AM01	DFN (Pb-Free)	5000 / Tape & Reel
NCP693HMN10TCG	1.0	AM03	DFN (Pb-Free)	5000 / Tape & Reel
NCP693HMN12TCG	1.2	AM06	DFN (Pb-Free)	5000 / Tape & Reel
NCP693HMN25TCG	2.5	AM20	DFN (Pb-Free)	5000 / Tape & Reel
NCP693HMN33TCG	3.3	AM29	DFN (Pb-Free)	5000 / Tape & Reel
NCP693DMN08TCG	0.8	AN01	DFN (Pb-Free)	5000 / Tape & Reel
NCP693DMN10TCG	1.0	AN03	DFN (Pb-Free)	5000 / Tape & Reel
NCP693DMN12TCG	1.2	AN06	DFN (Pb-Free)	5000 / Tape & Reel
NCP693DMN25TCG	2.5	AN20	DFN (Pb-Free)	5000 / Tape & Reel
NCP693DMN33TCG	3.3	AN29	DFN (Pb-Free)	5000 / Tape & Reel

[†]For information on tape and reel specifications, including part orientation and tape sizes, please refer to our Tape and Reel Packaging Specifications Brochure, BRD8011/D.

MECHANICAL CASE OUTLINE

PACKAGE DIMENSIONS

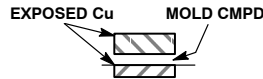
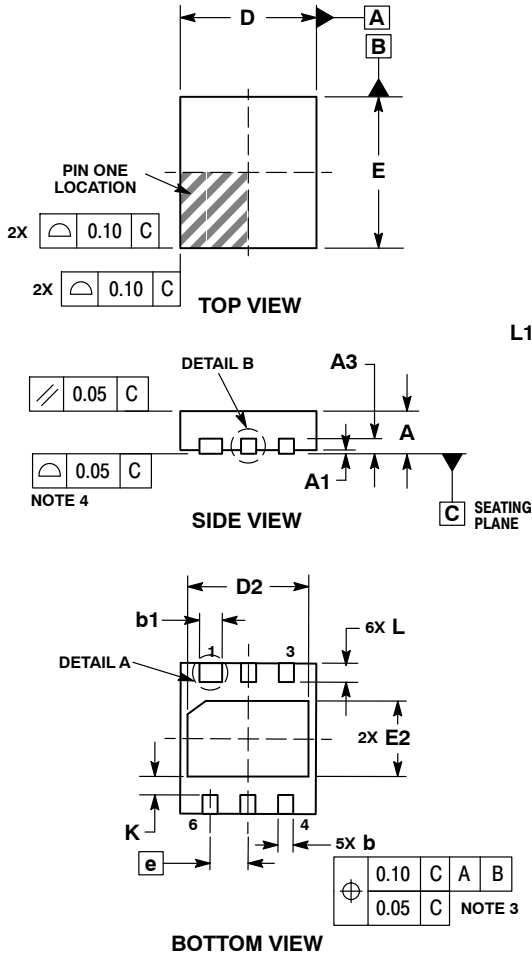
ON Semiconductor®



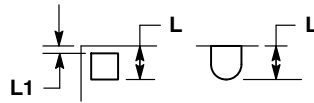
SCALE 4:1

UDFN6, 1.8x2, 0.5P
CASE 517BA-01
ISSUE A

DATE 08 SEP 2009



DETAIL B
OPTIONAL
CONSTRUCTIONS



DETAIL A
OPTIONAL
CONSTRUCTIONS

NOTES:

1. DIMENSIONING AND TOLERANCING PER ASME Y14.5M, 1994.
2. CONTROLLING DIMENSION: MILLIMETERS.
3. DIMENSION b APPLIES TO PLATED TERMINAL AND IS MEASURED BETWEEN 0.15 AND 0.20mm FROM THE TERMINAL TIP.
4. COPLANARITY APPLIES TO THE EXPOSED PAD AS WELL AS THE TERMINALS.

DIM	MILLIMETERS	
	MIN	MAX
A	0.50	0.60
A1	0.00	0.05
A3	0.20 REF	
b	0.15	0.30
b1	0.20	0.40
D	1.80 BSC	
D2	1.50	1.70
E	2.00 BSC	
E2	0.90	1.10
e	0.50 BSC	
K	0.20	---
L	0.15	0.35
L1	---	0.10

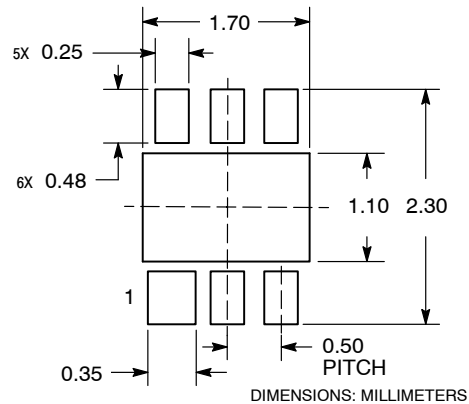
GENERIC MARKING DIAGRAM*



XXXX = Specific Device Code
MM = Lot Number

*This information is generic. Please refer to device data sheet for actual part marking. Pb-Free indicator, "G" or microdot "•", may or may not be present.

RECOMMENDED MOUNTING FOOTPRINT*



*For additional information on our Pb-Free strategy and soldering details, please download the ON Semiconductor Soldering and Mounting Techniques Reference Manual, SOLDERRM/D.

DOCUMENT NUMBER:	98AON44546E	Electronic versions are uncontrolled except when accessed directly from the Document Repository. Printed versions are uncontrolled except when stamped "CONTROLLED COPY" in red.
DESCRIPTION:	UDFN6 1.8X2, 0.5P	PAGE 1 OF 1

ON Semiconductor and ON are trademarks of Semiconductor Components Industries, LLC dba ON Semiconductor or its subsidiaries in the United States and/or other countries. ON Semiconductor reserves the right to make changes without further notice to any products herein. ON Semiconductor makes no warranty, representation or guarantee regarding the suitability of its products for any particular purpose, nor does ON Semiconductor assume any liability arising out of the application or use of any product or circuit, and specifically disclaims any and all liability, including without limitation special, consequential or incidental damages. ON Semiconductor does not convey any license under its patent rights nor the rights of others.

onsemi, **Onsemi**, and other names, marks, and brands are registered and/or common law trademarks of Semiconductor Components Industries, LLC dba "**onsemi**" or its affiliates and/or subsidiaries in the United States and/or other countries. **onsemi** owns the rights to a number of patents, trademarks, copyrights, trade secrets, and other intellectual property. A listing of **onsemi**'s product/patent coverage may be accessed at www.onsemi.com/site/pdf/Patent-Marking.pdf. **onsemi** reserves the right to make changes at any time to any products or information herein, without notice. The information herein is provided "as-is" and **onsemi** makes no warranty, representation or guarantee regarding the accuracy of the information, product features, availability, functionality, or suitability of its products for any particular purpose, nor does **onsemi** assume any liability arising out of the application or use of any product or circuit, and specifically disclaims any and all liability, including without limitation special, consequential or incidental damages. Buyer is responsible for its products and applications using **onsemi** products, including compliance with all laws, regulations and safety requirements or standards, regardless of any support or applications information provided by **onsemi**. "Typical" parameters which may be provided in **onsemi** data sheets and/or specifications can and do vary in different applications and actual performance may vary over time. All operating parameters, including "Typicals" must be validated for each customer application by customer's technical experts. **onsemi** does not convey any license under any of its intellectual property rights nor the rights of others. **onsemi** products are not designed, intended, or authorized for use as a critical component in life support systems or any FDA Class 3 medical devices or medical devices with a same or similar classification in a foreign jurisdiction or any devices intended for implantation in the human body. Should Buyer purchase or use **onsemi** products for any such unintended or unauthorized application, Buyer shall indemnify and hold **onsemi** and its officers, employees, subsidiaries, affiliates, and distributors harmless against all claims, costs, damages, and expenses, and reasonable attorney fees arising out of, directly or indirectly, any claim of personal injury or death associated with such unintended or unauthorized use, even if such claim alleges that **onsemi** was negligent regarding the design or manufacture of the part. **onsemi** is an Equal Opportunity/Affirmative Action Employer. This literature is subject to all applicable copyright laws and is not for resale in any manner.

PUBLICATION ORDERING INFORMATION

LITERATURE FULFILLMENT:

Email Requests to: orderlit@onsemi.com

onsemi Website: www.onsemi.com

TECHNICAL SUPPORT

North American Technical Support:
Voice Mail: 1 800-282-9855 Toll Free USA/Canada
Phone: 011 421 33 790 2910

Europe, Middle East and Africa Technical Support:

Phone: 00421 33 790 2910

For additional information, please contact your local Sales Representative