

# 1/3-Inch CMOS Digital Image Sensor

## MT9M034

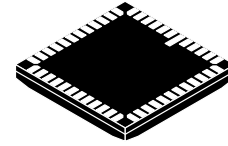

ILCC48 10x10  
CASE 847AD

Table 1. KEY PARAMETERS

Parameter		Value
Optical Format		1/3-inch (6 mm)
Active Pixels		1280 × 960 = 1.2 Mp
Pixel Size		3.75 μm
Color Filter Array		RGB Bayer or Monochrome
Shutter Type		Electronic Rolling Shutter
Input Clock Range		6–50 MHz
Output Clock Maximum		74.25 MHz
Output	Parallel	12-bit
Frame Rate	Full Resolution	45 fps
	720p	60 fps
Responsivity		5.48 V/lux-sec
SNR <sub>MAX</sub>		43.9 dB
Maximum Dynamic Range		>115 dB
Supply Voltage	I/O	1.8 V* or 2.8 V
	Digital	1.8 V
	Analog	2.8 V
Power Consumption		270 mW (1280 × 720 60 fps Parallel Output Linear Mode) 460 mW (1280 × 720 60 fps Parallel Output HDR Mode)
Operating Temperature (ambient) –T <sub>A</sub>		–30°C to + 70°C (Surveillance)
Package Options		10×10 mm 48-pin iLCC
		Bare Die

\*1.8 V VDD\_IO is recommended due to better row noise performance

### ORDERING INFORMATION

See detailed ordering and shipping information on page 2 of this data sheet.

### Features

- Superior Low-light performance
- HD Video (720p60)
- Linear or High Dynamic Range Capture
- Video/Single Frame Modes
- On-chip AE and Statistics Engine
- Parallel and Serial Output
- Auto Black Level Calibration
- Context Switching
- Temperature Sensor

### Applications

- Video Surveillance
- 720p60 Video Applications
- High Dynamic Range Imaging

ORDERING INFORMATION

Table 2. AVAILABLE PART NUMBERS

Part Number	Product Description	Orderable Product Attribute Description
MT9M034I12STC-DPBR1	1.2 MP 1/3" CIS	Dry Pack with Protective Film, Double Side BBAR Glass
MT9M034I12STC-DRBR1	1.2 MP 1/3" CIS	Dry Pack without Protective Film, Double Side BBAR Glass
MT9M034I12STM-DPBR1	1.2 MP 1/3" CIS	Dry Pack with Protective Film, Double Side BBAR Glass
MT9M034I12STM-DRBR	1.2 MP 1/3" CIS	Dry Pack without Protective Film, Double Side BBAR Glass

GENERAL DESCRIPTION

The **onsemi** MT9M034 is a 1/3-inch CMOS digital image sensor with an active-pixel array of 1280 (H) × 960 (V). It captures images in either linear or high dynamic range modes, with a rolling-shutter readout. It includes sophisticated camera functions such as auto exposure control, windowing, and both video and single frame modes. It is designed for both low light and high dynamic range scene performance. It is programmable through a simple two-wire serial interface. The MT9M034 produces extraordinarily clear, sharp digital pictures, and its ability to capture both continuous video and single frames makes it the perfect choice for a wide range of applications, including surveillance and HD video.

The **onsemi** MT9M034 can be operated in its default mode or programmed for frame size, exposure, gain, and other parameters. The default mode output is a 960p-resolution image at 45 frames per second (fps). In linear mode, it outputs 12-bit raw data. In high dynamic range mode, it outputs 12-bit compressed data using parallel output. The device may be operated in video (master) mode or in single frame trigger mode.

FRAME\_VALID and LINE\_VALID signals are output on dedicated pins, along with a synchronized pixel clock in parallel mode.

The MT9M034 includes additional features to allow application-specific tuning; windowing and offset, adjustable auto-exposure control, auto black level correction, and on-board temperature sensor. Optional register information and histogram statistic information can be embedded in first and last two lines of the image frame.

The sensor is designed to operate in a wide temperature range (-30°C to +70°C).

FUNCTIONAL OVERVIEW

The MT9M034 is a progressive-scan sensor that generates a stream of pixel data at a constant frame rate. It uses an on-chip, phase-locked loop (PLL) that can be optionally enabled to generate all internal clocks from a single master input clock running between 6 and 50 MHz. The maximum output pixel rate is 74.25 Mp/s, corresponding to a clock rate of 74.25 MHz. Figure 1 shows a block diagram of the sensor.

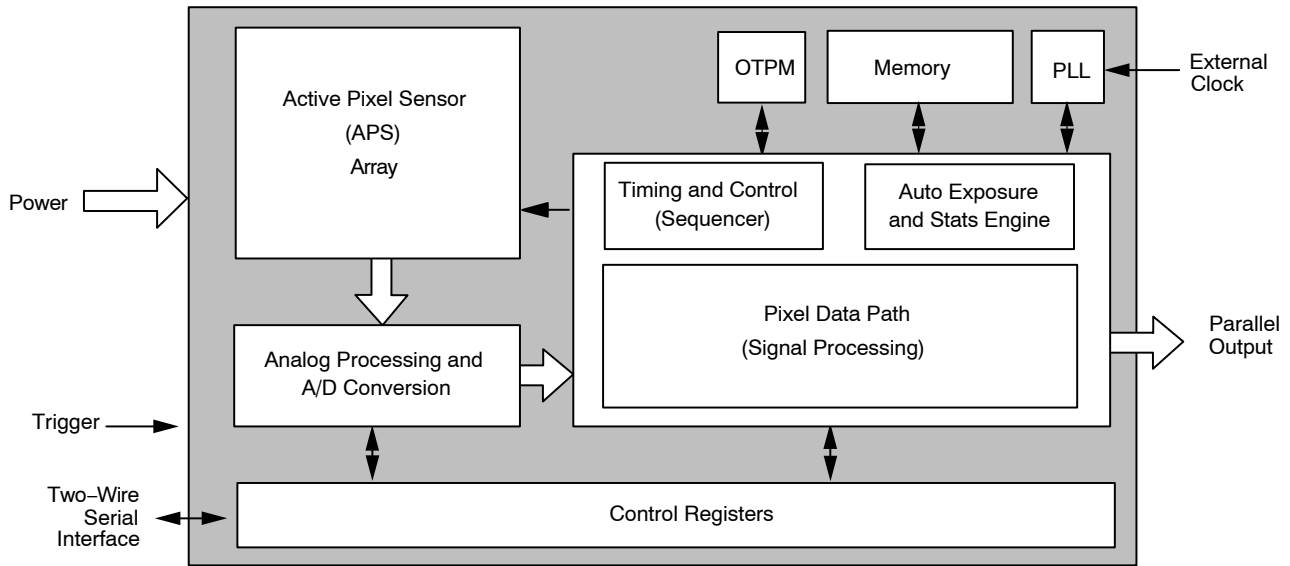
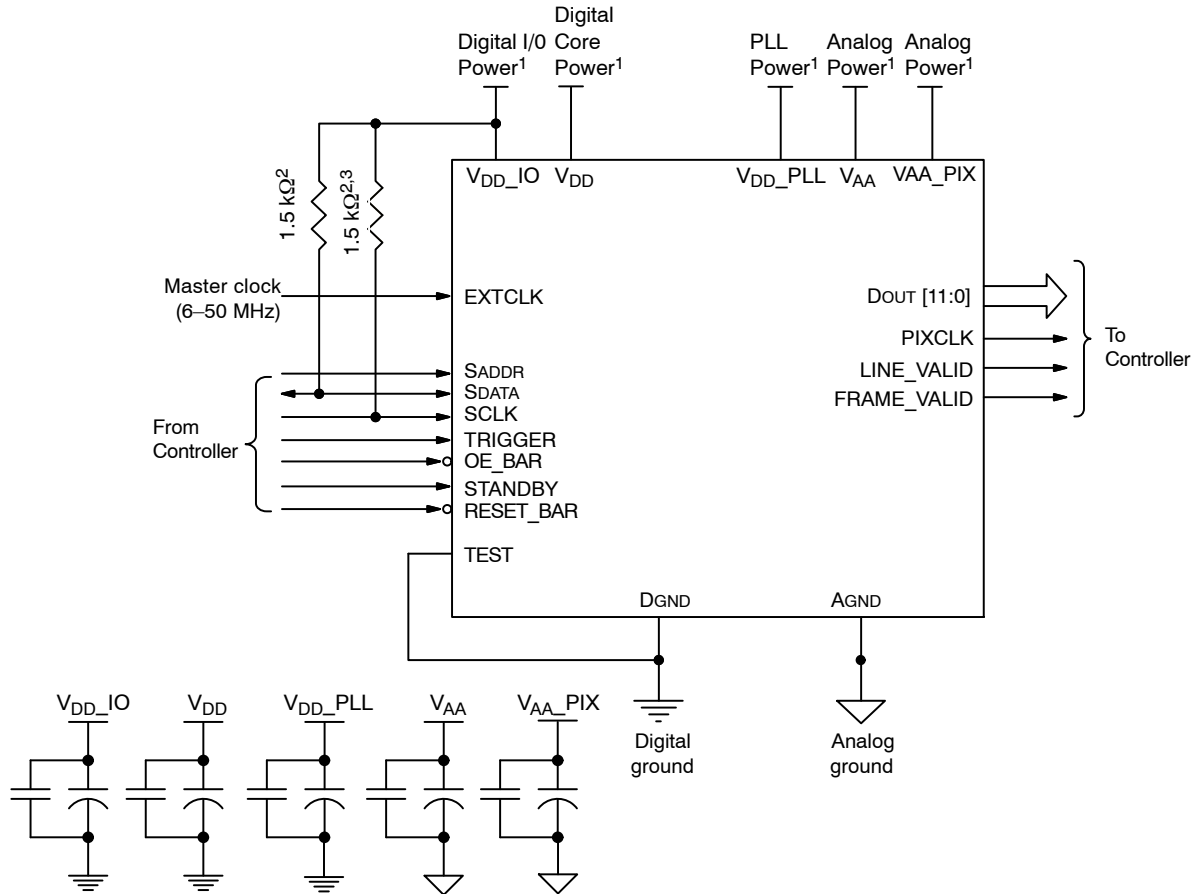

Figure 1. Block Diagram

## MT9M034

User interaction with the sensor is through the two-wire serial bus, which communicates with the array control, analog signal chain, and digital signal chain. The core of the sensor is a 1.2 Mp Active-Pixel Sensor array. The timing and control circuitry sequences through the rows of the array, resetting and then reading each row in turn. In the time interval between resetting a row and reading that row, the pixels in the row integrate incident light. The exposure is controlled by varying the time interval between reset and readout. Once a row has been read, the data from the columns is sequenced through an analog signal chain (providing offset correction and gain), and then through an

analog-to-digital converter (ADC). The output from the ADC is a 12-bit value for each pixel in the array. The ADC output passes through a digital processing signal chain (which provides further data path corrections and applies digital gain). The sensor also offers a high dynamic range mode of operation where multiple images are combined on-chip to produce a single image at 20-bit per pixel value. A compressing mode is further offered to allow this 20-bit pixel value to be transmitted to the host system as a 12-bit value with close to zero loss in image quality. The pixel data are output at a rate of up to 74.25 Mp/s, in parallel to frame and line synchronization signals.



1. All power supplies should be adequately decoupled.
2. **onsemi** recommends a resistor value of 1.5 k $\Omega$ , but a greater value may be used for slower two-wire speed.
3. The serial interface output pads and V<sub>DD</sub>SLVS can be left unconnected if the parallel output interface is used.
4. **onsemi** recommends that 0.1  $\mu$ F and 10  $\mu$ F decoupling capacitors for each power supply are mounted as close as possible to the pad. Actual values and results may vary depending on layout and design considerations. Check the demo headboard schematics for circuit recommendations.
5. **onsemi** recommends that analog power planes are placed in a manner such that coupling with the digital power planes is minimized.
6. I/O signals voltage must be configured to match V<sub>DD</sub>\_IO voltage to minimize any leakage currents.
7. The serial interface output pads and V<sub>DD</sub>SLVS can be left unconnected if the parallel output interface is used.

**Figure 2. Typical Configuration: Parallel Pixel Data Interface**

# MT9M034

		6	5	4	3	2	1	48	47	46	45	44	43		
		D <sub>GND</sub>	EXTCLK	V <sub>DD_PLL</sub>	D <sub>OUT6</sub>	D <sub>OUT5</sub>	D <sub>OUT4</sub>	D <sub>OUT3</sub>	D <sub>OUT2</sub>	D <sub>OUT1</sub>	D <sub>OUT0</sub>	D <sub>GND</sub>	NC		
7	D <sub>OUT7</sub>												NC	42	
8	D <sub>OUT8</sub>												NC	41	
9	D <sub>OUT9</sub>												V <sub>AA</sub>	40	
10	D <sub>OUT10</sub>												A <sub>GND</sub>	39	
11	D <sub>OUT11</sub>												V <sub>AA_PIX</sub>	38	
12	V <sub>DD_IO</sub>												V <sub>AA_PIX</sub>	37	
13	PIXCLK												V <sub>AA</sub>	36	
14	V <sub>DD</sub>												A <sub>GND</sub>	35	
15	S <sub>CLK</sub>												V <sub>AA</sub>	34	
16	S <sub>DATA</sub>												Reserved	33	
17	RESET_BAR												Reserved	32	
18	V <sub>DD_IO</sub>												Reserved	31	
		19	20	21	22	23	24	25	26	27	28	29	30		
		V <sub>DD</sub>	NC	NC	STANDBY	OE_BAR	S <sub>ADDR</sub>	TEST	FLASH	TRIGGER	FRAME_VALID	LINE_VALID	D <sub>GND</sub>		

Figure 3. 48 iLCC Package, Parallel Output

## MT9M034

**Table 3. PIN DESCRIPTION**

Pin Number	Name	Type	Description
1	DOUT4	Output	Parallel pixel data output
2	DOUT5	Output	Parallel pixel data output
3	DOUT6	Output	Parallel pixel data output
4	VDD_PLL	Power	PLL power
5	EXTCLK	Input	External input clock
6	DGND	Power	Digital ground
7	DOUT7	Output	Parallel pixel data output
8	DOUT8	Output	Parallel pixel data output
9	DOUT9	Output	Parallel pixel data output
10	DOUT10	Output	Parallel pixel data output
11	DOUT11	Output	Parallel pixel data output (MSB)
12	VDD_IO	Power	I/O supply power
13	PIXCLK	Output	Pixel clock out. DOUT is valid on rising edge of this clock
14	VDD	Power	Digital power
15	SCLK	Input	Two-Wire Serial clock input
16	SDATA	I/O	Two-Wire Serial data I/O
17	RESET_BAR	Input	Asynchronous reset (active LOW). All settings are restored to factory default
18	VDD_IO	Power	I/O supply power
19	VDD	Power	Digital power
20	NC		
21	NC		
22	STANDBY	Input	Standby-mode enable pin (active HIGH)
23	OE_BAR	Input	Output enable (active LOW)
24	SADDR	Input	Two-Wire Serial address select
25	TEST	Input	Manufacturing test enable pin (connect to DGND)
26	FLASH	Output	Flash output control
27	TRIGGER	Input	Exposure synchronization input
28	FRAME_VALID	Output	Asserted when DOUT frame data is valid
29	LINE_VALID	Output	Asserted when DOUT line data is valid
30	DGND	Power	Digital ground
31	Reserved		NC
32	Reserved		NC
33	Reserved		NC
34	VAA	Power	Analog power
35	AGND	Power	Analog ground
36	VAA	Power	Analog power
37	VAA_PIX	Power	Pixel power
38	VAA_PIX	Power	Pixel power
39	AGND	Power	Analog ground
40	VAA	Power	Analog power
41	NC		

## MT9M034

**Table 3. PIN DESCRIPTION** (continued)

Pin Number	Name	Type	Description
42	NC		
43	NC		
44	DGND	Power	Digital ground
45	DOUT0	Output	Parallel pixel data output (LSB)
46	DOUT1	Output	Parallel pixel data output
47	DOUT2	Output	Parallel pixel data output
48	DOUT3	Output	Parallel pixel data output

# MT9M034

## PIXEL DATA FORMAT

### Pixel Array Structure

The MT9M034 pixel array is configured as 1412 columns by 1028 rows, (see Figure 4). The dark pixels are optically black and are used internally to monitor black level. Of the right 100 columns, 64 are dark pixels used for row noise correction. Of the top 24 rows of pixels, 12 of the dark rows are used for black level correction. There are 1296 columns

by 976 rows of optically active pixels. While the sensor's format is  $1280 \times 960$ , the additional active columns and active rows are included for use when horizontal or vertical mirrored readout is enabled, to allow readout to start on the same pixel. The pixel adjustment is always performed for monochrome or color versions. The active area is surrounded with optically transparent dummy pixels to improve image uniformity within the active area. Not all dummy pixels or barrier pixels can be read out.

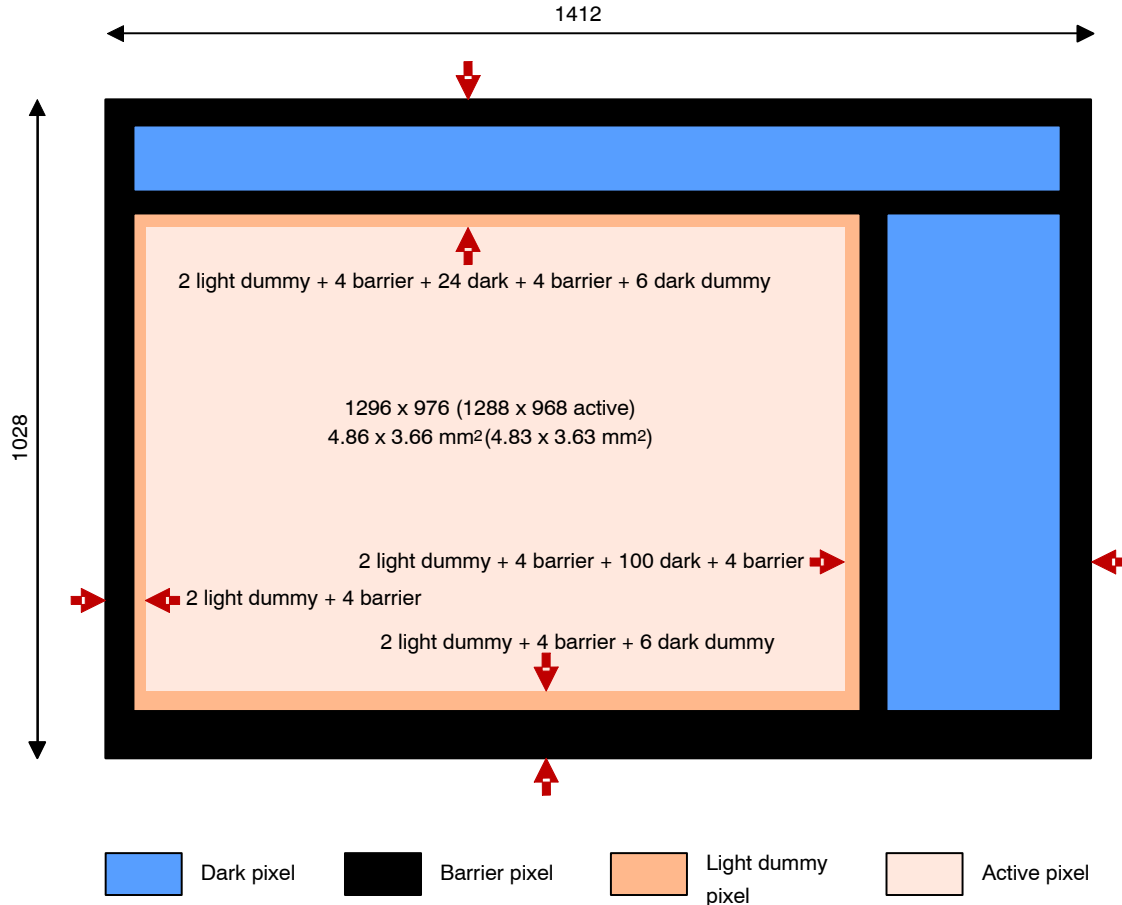
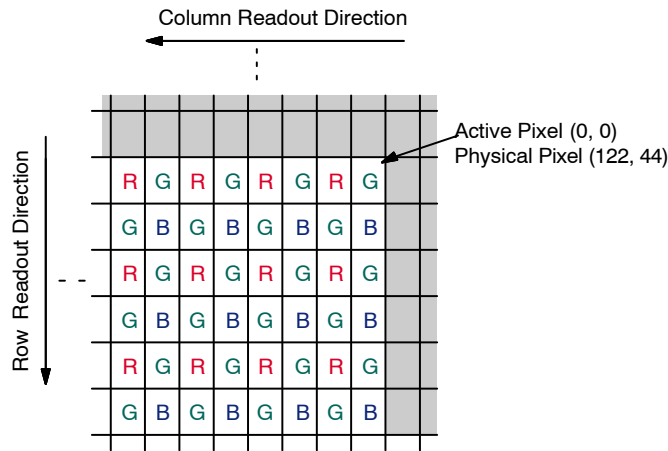

Figure 4. Pixel Array Description

# MT9M034

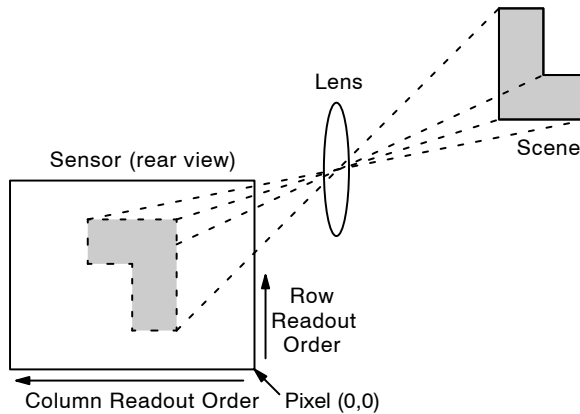

**Figure 5. Pixel Color Pattern Detail (Top Right Corner)**

### Default Readout Order

By convention, the sensor core pixel array is shown with pixel (0,0) in the top right corner (see Figure 5). This reflects the actual layout of the array on the die. Also, the first pixel data read out of the sensor in default condition is that of pixel (112, 44).

When the sensor is imaging, the active surface of the sensor faces the scene as shown in Figure 6. When the image is read out of the sensor, it is read one row at a time, with the rows and columns sequenced as shown in Figure 6.



**Figure 6. Imaging a Scene**

### Digital Gain Control

MT9M034 supports four digital gains for the color channels: Red, Green1 (green pixels on the red rows), Green2 (green pixels on the blue rows), and Blue. Digital

gain control of the MT9M034 is dependent on the configuration of the `x_addr_start` register. Table 4 illustrates how the digital gains are applied when `x_addr_start` is even or odd number.

**Table 4. DIGITAL GAIN CONTROL FOR ODD AND EVEN X\_ADDR\_START (R0X3004)**

Pixels	x_addr_start	Gain	Register
Red	Even	red_gain	R0x305A
	Odd	green1_gain	R0x3056
Green1 (on Red rows)	Even	green1_gain	R0x3056
	Odd	red_gain	R0x305A
Green2 (on Blue rows)	Even	green2_gain	R0x305C
	Odd	blue_gain	R0x3058



# MT9M034

**Table 4. DIGITAL GAIN CONTROL FOR ODD AND EVEN X\_ADDR\_START (R0X3004)**

Pixels	x_addr_start	Gain	Register
Blue	Even	blue_gain	R0x3058
	Odd	green2_gain	R0x305C

## OUTPUT DATA FORMAT

The MT9M034 image data is read out in a progressive scan. Valid image data is surrounded by horizontal and vertical blanking (see Figure 7). The amount of horizontal row time (in clocks) is programmable through R0x300C. The amount of vertical frame time (in rows) is

programmable through R0x300A. Line\_Valid (LV) is HIGH during the shaded region of Figure 7. Optional Embedded Register setup information and Histogram statistic information are available in first two and last row of image data.

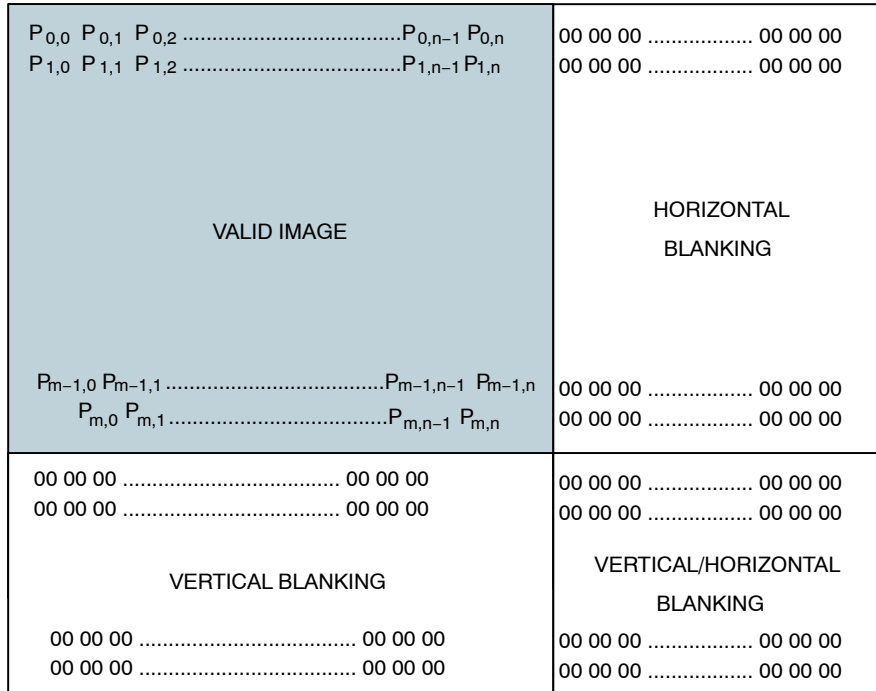

**Figure 7. Spatial Illustration of Image Readout**

## Readout Sequence

Typically, the readout window is set to a region including only active pixels. The user has the option of reading out

dark regions of the array, but if this is done, consideration must be given to how the sensor reads the dark regions for its own purposes.

**Parallel Output Data Timing**

The output images are divided into frames, which are further divided into lines. By default, the sensor produces 968 rows of 1284 columns each. The FV and LV signals indicate the boundaries between frames and lines, respectively. PIXCLK can be used as a clock to latch the

data. For each PIXCLK cycle, with respect to the falling edge, one 12-bit pixel datum outputs on the DOUT pins. When both FV and LV are asserted, the pixel is valid. PIXCLK cycles that occur when FV is de-asserted are called vertical blanking. PIXCLK cycles that occur when only LV is de-asserted are called horizontal blanking.

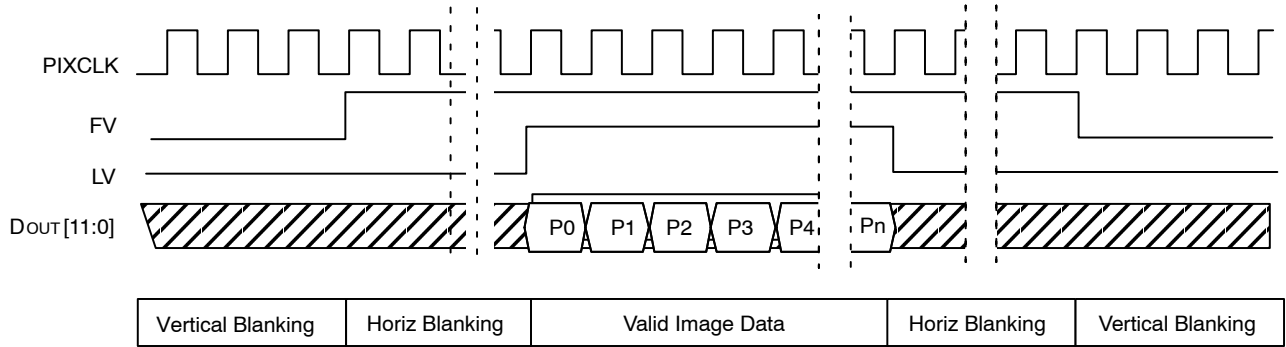

**Figure 8. Default Pixel Output Timing**

**LV and FV**

The timing of the FV and LV outputs is closely related to the row time and the frame time.

FV will be asserted for an integral number of row times, which will normally be equal to the height of the output image.

LV will be asserted during the valid pixels of each row. The leading edge of LV will be offset from the leading edge

of FV by 6 PIXCLKs. Normally, LV will only be asserted if FV is asserted; this is configurable as described below.

*LV Format Options*

The default situation is for LV to be de-asserted when FV is de-asserted. By configuring R0x306E[1:0], the LV signal can take two different output formats. The formats for reading out four lines and two vertical blanking lines are shown in Figure 9.

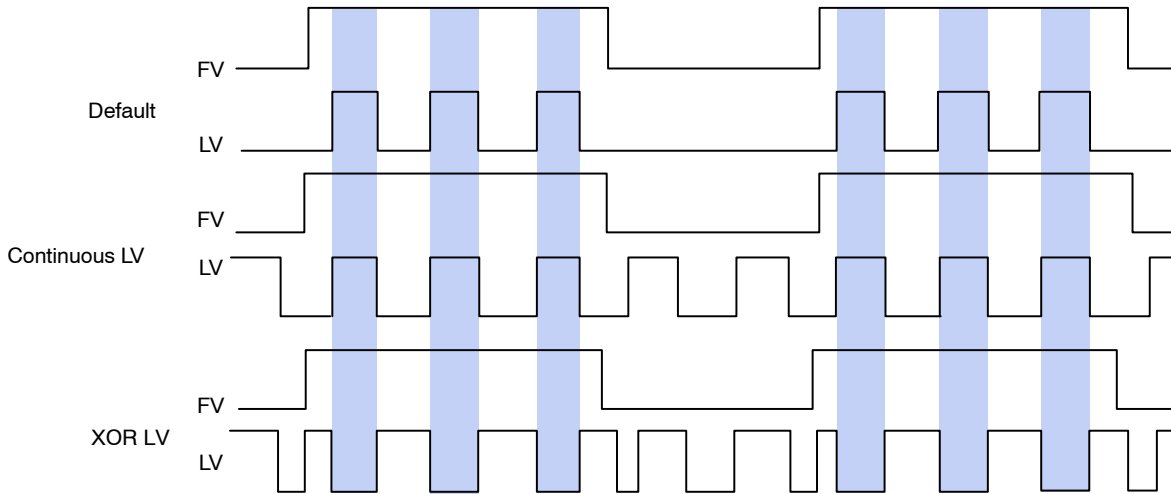

**Figure 9. LV Format Options**

The timing of an entire frame is shown in Figure 10.

## MT9M034

### Frame Time

The pixel clock (PIXCLK) represents the time needed to sample 1 pixel from the array. The sensor outputs data at the maximum rate of 1 pixel per PIXCLK. One row time

( $t_{ROW}$ ) is the period from the first pixel output in a row to the first pixel output in the next row. The row time and frame time are defined by equations in Table 5.

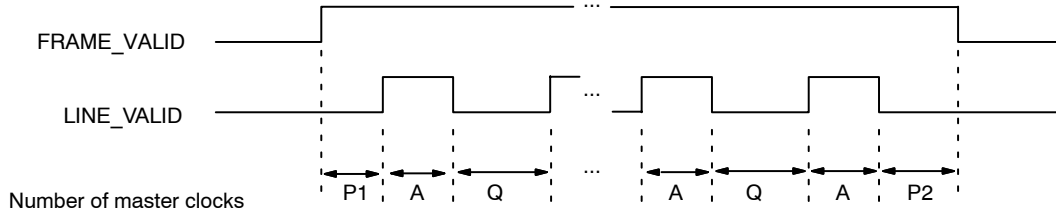

Figure 10. Line Timing and FRAME\_VALID/LINE\_VALID Signals

Table 5. FRAME TIME (EXAMPLE BASED ON 1280 X 960, 45 FRAMES PER SECOND)

Parameters	Name	Equation	Default Timing at 74.25 MHz
A	Active Data Time	Context A: $R0x3008 - R0x3004 + 1$ Context B: $R0x308E - R0x308A + 1$	1280 pixel clocks = 17.23 $\mu$ s
P1	Frame Start Blanking	6 (fixed)	6 pixel clocks = 0.08 $\mu$ s
P2	Frame End Blanking	6 (fixed)	6 pixel clocks = 0.08 $\mu$ s
Q	Horizontal Blanking	$R0x300C - A$	370 pixel clocks = 4.98 $\mu$ s
A + Q (tROW)	Line (Row) Time	$R0x300C$	1650 pixel clocks = 22.22 $\mu$ s
V	Vertical Blanking	Context A: $(R0x300A - (R0x3006 - R0x3002 + 1)) \times (A + Q)$ Context B: $((R0x30AA - (R0x3090 - R0x308C + 1)) \times (A + Q))$	49,500 pixel clocks = 666.66 $\mu$ s
Nrows $\times$ (A + Q)	Frame Valid Time	Context A: $((R0x3006 - R0x3002 + 1) \times (A + Q)) - Q + P1 + P2$ Context B: $((R0x3090 - R0x308C + 1) \times (A + Q)) - Q + P1 + P2$	1,584,000 pixel clocks = 21.33 ms
F	Total Frame Time	$V + (Nrows \times (A + Q))$	1,633,500 pixel clocks = 22.22 ms

Sensor timing is shown in terms of pixel clock cycles (see Figure 7). The recommended pixel clock frequency is 74.25 MHz. The vertical blanking and the total frame time equations assume that the integration time (coarse integration time plus fine integration time) is less than the number of active lines plus the blanking lines:

$$\text{Window Height} + \text{Vertical Blanking} \quad (\text{eq. 1})$$

If this is not the case, the number of integration lines must be used instead to determine the frame time, (see Table 6). In this example, it is assumed that the coarse integration time

control is programmed with 2000 rows and the fine shutter width total is zero.

For Master mode, if the integration time registers exceed the total readout time, then the vertical blanking time is internally extended automatically to adjust for the additional integration time required. This extended value is not written back to the frame\_length\_lines register. The frame\_length\_lines register can be used to adjust frame-to-frame readout time. This register does not affect the exposure time but it may extend the readout time.

**Table 6. FRAME TIME: LONG INTEGRATION TIME**

Parameters	Name	Equation (Number of Pixel Clock Cycles)	Default Timing at 74.25 MHz
F'	Total Frame Time (Long Integration Time)	Context A: (R0x3012 x (A + Q)) + R0x3014 + P1 + P2 Context B: (R0x3016 x (A + Q)) + V R0x3018 + P1 + P2	3,300,012 pixel clocks = 44.44 ms

1. The MT9M034 uses column parallel analog–digital converters; thus short line timing is not possible. The minimum total line time is 1650 columns (horizontal width + horizontal blanking) for HDR mode and 1400 for linear mode. The minimum horizontal blanking is 370.

**Exposure**

Total integration time is the result of Coarse\_Integration\_Time and Fine\_Integration\_Time registers, and depends also on whether manual or automatic exposure is selected.

The actual total integration time,  $t_{INT}$  is defined as:

$$t_{INT} = t_{INTCoarse} - 410 - t_{INTFine} \quad (\text{eq. 2})$$

= (number of lines of integration x line time) – (410 pixel clocks of conversion time overhead) – (number of pixels of integration x pixel time)

where:

- ◆ Number of Lines of Integration (Auto Exposure Control: Enabled)  
When automatic exposure control (AEC) is enabled, the number of lines of integration may vary from frame to frame, with the limits controlled by R0x311E (minimum auto exposure time) and R0x311C (maximum auto exposure time)
- ◆ Number of Lines of Integration (Auto Exposure Control: Disabled)  
If AEC is disabled, the number of lines of integration equals the value in R0x3012 (context A) or R0x3016 (context B)

- ◆ Number of Pixels of Integration  
The number of fine shutter width pixels is independent of AEC mode (enabled or disabled):
  - ◆ Context A: the number of pixels of integration equals the value in R0x3014
  - ◆ Context B: the number of pixels of integration equals the value in R0x3018. Maximum value for  $t_{INTFINE}$  is line length pixel clocks – 611

Typically, the value of the Coarse\_Integration\_Time register is limited to the number of lines per frame (which includes vertical blanking lines), such that the frame rate is not affected by the integration time. For more information on coarse and fine integration time settings limits, please refer to the Register Reference document.

NOTE: In HDR mode, there are specific limitations on coarse\_integration\_time due to the number of line buffers available. Please refer to the section called “HDR Specific Exposure Settings”.

For best image quality, it is recommended that the integration time be set to two rows or greater for the shortest exposure, particularly for monochrome sensors. For linear mode, this would be the coarse integration time (R0x3012). For HDR mode, the integration time should be set such that the T3 exposure is two rows or greater. Setting the exposure time to 1 row may result in non–uniformity between rows.

**HIGH DYNAMIC RANGE MODE**

By default, the sensor powers up in Linear Mode, however, the MT9M034 can be configured to run in HDR mode. The HDR scheme used is multi-exposure HDR. This allows the sensor to handle 120 dB of dynamic range. The sensor also features a linear mode. In HDR mode, the sensor sequentially captures three exposures by maintaining 3 separate read and reset pointers that are interleaved within the rolling shutter readout. The intermediate pixel values are

stored in line buffers while waiting for the 3 exposures values to be present. As soon as a pixel's 3 exposure values are available, they are combined to create a linearized 20-bit value for each pixel's response. This 20-bit value is then optionally compressed back to a 12- or 14-bit value for output. For 14-bit mode, the compressing is lossless. In 12-bit mode, there is minimal data loss. Figure 11 shows the HDR data compression:

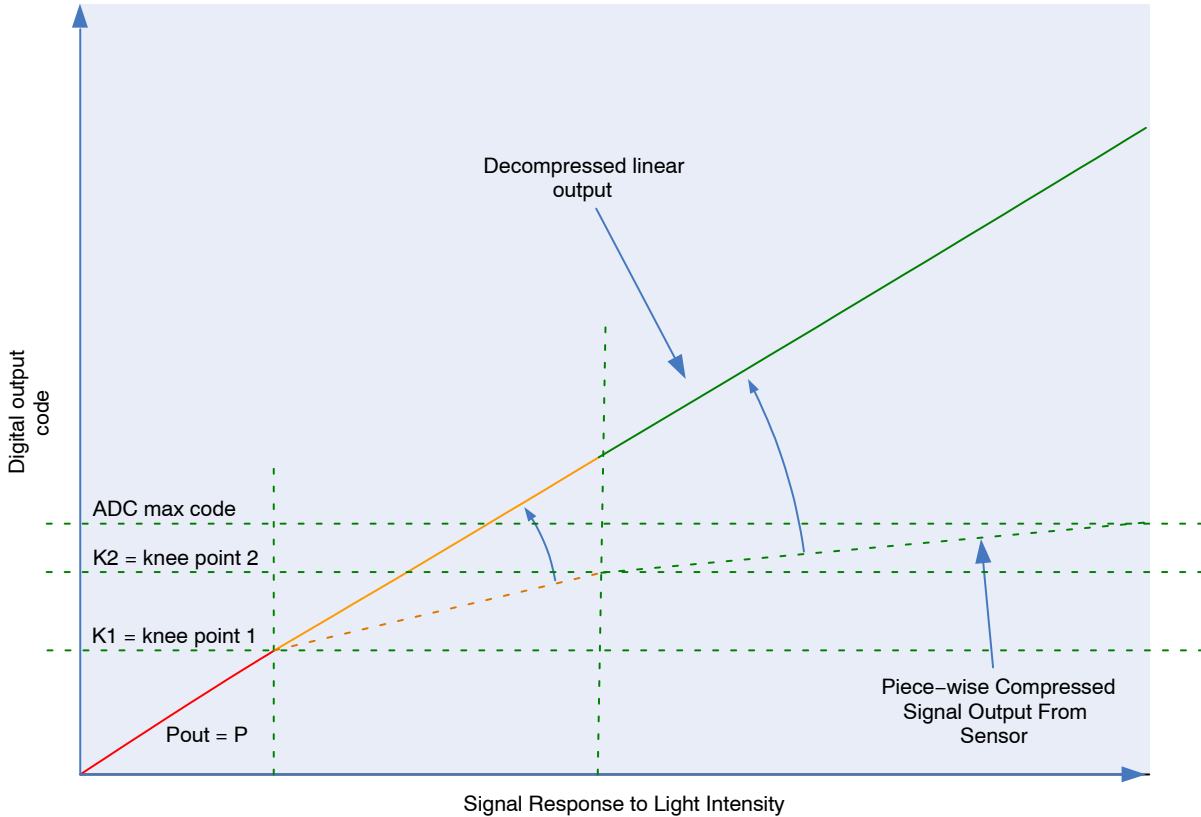

**Figure 11. HDR Data Compression**

## MT9M034

The HDR mode is selected when Operation\_Mode\_Ctrl, R0x3082[1:0] = 0. Further controls on exposure time limits and compressing are controlled by R0x3082[5:2], and R0x31D0. More details can be found in the MT9M034 Register Reference.

In HDR mode, when compression is used, there are two types of knee-points: (i) T1/T2 and T2/T3 capture

knee-points and (ii) P<sub>OUT</sub> and P<sub>out2</sub> compression knee-points (Figure 11). Aligning the capture knee-points on top of the compression knee-points, can avoid code losses (SNR loss) in the compression. Tables 7 and 8 below show the knee points for the different modes. Alternatively, the sensor automatically reports the knee points and can be read directly from registers R0x319A and R0x319C.

**Table 7. KNEE POINTS FOR COMPRESSION TO 14 BITS**

T1/T2 Exposure Ratio (R1) R0x3082[3:2]	P1	P <sub>OUT</sub> <sup>1</sup> = P1	P2	P <sub>OUT</sub> <sup>2</sup> = (P2 - P1) / R1 + P <sub>OUT</sub> <sup>1</sup>	T2/T3 Exposure Ratio (R2) R0x3082[5:4]	P <sub>MAX</sub>	P <sub>OUT</sub> <sup>MAX</sup> = (P <sub>MAX</sub> - P2) / (R1 × R2) + P <sub>OUT</sub> <sup>2</sup>
4x	2 <sup>12</sup>	4096	2 <sup>14</sup>	7168	4x	2 <sup>16</sup>	10240
					8x	2 <sup>17</sup>	10752
					16x	2 <sup>18</sup>	11008
8x	2 <sup>12</sup>	4096	2 <sup>15</sup>	7680	4x	2 <sup>17</sup>	10752
					8x	2 <sup>18</sup>	11264
					16x	2 <sup>19</sup>	11520
16x	2 <sup>12</sup>	4096	2 <sup>16</sup>	7936	4x	2 <sup>18</sup>	11008
					8x	2 <sup>19</sup>	11520
					16x	2 <sup>20</sup>	11776

**Table 8. KNEE POINTS FOR COMPRESSION TO 12 BITS**

T1/T2 Exposure Ratio (R1) R0x3082[3:2]	P1	P <sub>OUT</sub> <sup>1</sup> = P1	P2	P <sub>OUT</sub> <sup>2</sup> = (P2 - P1) / R1 + P <sub>OUT</sub> <sup>1</sup>	T2/T3 Exposure Ratio (R2) R0x3082[5:4]	P <sub>MAX</sub>	P <sub>OUT</sub> <sup>MAX</sup> = (P <sub>MAX</sub> - P2) / (R1 × R2) + P <sub>OUT</sub> <sup>2</sup>
4x	2 <sup>11</sup>	2048	2 <sup>14</sup>	2944	8x	2 <sup>17</sup>	3840
					16x	2 <sup>18</sup>	3904
8x	2 <sup>11</sup>	2048	2 <sup>15</sup>	3008	4x	2 <sup>17</sup>	3776
					8x	2 <sup>18</sup>	3904
					16x	2 <sup>19</sup>	3968
16x	2 <sup>11</sup>	2048	2 <sup>16</sup>	3040	4x	2 <sup>18</sup>	3808
					8x	2 <sup>19</sup>	3936
					16x	2 <sup>20</sup>	4000

### HDR Specific Exposure Settings

In HDR mode, pixel values are stored in line buffers while waiting for all 3 exposures to be available for final pixel data combination. There are 42 line buffers used to store intermediate T1 data. Due to this limitation, the maximum coarse integration time possible is equal to 42 × T1 / T2 lines.

For example, if R0x3082[3:2] = 2, the sensor is set to have T1/T2 ratio = 16x. Therefore the maximum number of integration lines is 42 × 16 = 672 lines.

If coarse integration time is greater than this, the T2 integration time will stay at 42. The sensor will calculate the ratio internally, enabling the linearization to be performed. If companding is being than relinearization would still

follow the programmed ratio. For example if the T1 / T2 ratio was programmed to 16x but coarse integration was increased beyond 672 than one would still use the 16x relinearization formulas.

An additional limitation is the maximum number of exposure lines in relation to the frame\_length\_lines register. In Linear mode, maximum coarse\_integration\_time = frame\_length\_lines - 1. However in HDR mode, since the coarse integration time register controls T1, the max coarse\_integration\_time is frame\_length\_lines - 45.

Putting the two criteria listed above together, it can be summarized as follows:

## MT9M034

$$\text{maximum coarse\_integration\_time} = \text{minimum}(42 \times T1/T2, \text{frame\_length\_lines} - 45) \quad (\text{eq. 3})$$

In HDR mode, subline integration is not utilized. As such, fine integration time register changes will have no effect on the image.

There is also a limitation of the minimum number of exposure lines that can be used. This is summarized in the following formula:

$$\text{minimum coarse\_integration\_time} = (0.5) \times (T1/T2) \times (T2/T3) \quad (\text{eq. 4})$$

Due to limitation on the internal floating point calculation, the exact ratio specified by the `RATIO_T2_T3` (`R0x3082[5:4]`) may not be achievable.

= 16x), digital gain needs to be set to a fixed value. Table 9 provides the proper digital gain settings for each `T1 / T2` and `T2 / T3` ratio.

When using companded output in combination with certain exposure ratios (other than `T1 / T2 = 16x` and `T2 / T3`

**Table 9. DIGITAL GAIN SETTING FOR EACH `T1 / T2` AND `T2 / T3` RATIO**

<code>T1 / T2</code> Ratio	<code>T2 / T3</code> Ratio	Setting for Digital Gain Register ( <code>0x305E</code> Context A or <code>0x30C4</code> Context B)
4	4	0x02h
4	8	0x04h
4	16	0x08h
8	4	0x04h
8	8	0x08h
8	16	0x10h
16	4	0x08h
16	8	0x10h
16	16	Any Legal Value

### Motion Compensation

In typical multi-exposure HDR systems, motion artifacts can be created when objects move during the `T1`, `T2` or `T3` integration time. When this happens, edge artifacts can potentially be visible and might look like a ghosting effect.

To correct this feature, the MT9M034 has special 2D motion compensation circuitry that detects motion artifacts and corrects the image accordingly.

There are two motion compensation options available. One using the default HDR motion compensation by setting

`R0x318C[14] = 1`. Additional parameters are available to control the extent of motion detection and correction as per the requirements of the specific application. These can be set in `R0x318C`–`R0x3190`. The other is using the DLO method of HDR combination. When using DLO, `R0x318C[14]` is ignored. DLO is enabled by setting `R0x3190[13] = 1`. Noise filtering is enabled by setting `R0x3190[14] = 1`. For more information, please refer to the MT9M034 Register Reference document.

## MT9M034

### REAL-TIME CONTEXT SWITCHING

In the MT9M034, the user may switch between two full register sets (listed in Table 10) by writing to a context switch change bit in R0x30B0[13]. This context switch will

change all registers (no shadowing) at the frame start time and have the new values apply to the immediate next exposure and readout time.

**Table 10. REAL-TIME CONTEXT-SWITCH REGISTERS**

Register Description	Register Number	
	Context A	Context B
Y_Addr_Start	R0x3002	R0x308C
X_Addr_Start	R0x3004	R0x308A
Y_Addr_End	R0x3006	R0x3090
X_Addr_End	R0x3008	R0x308E
Coarse_Integration_Time	R0x3012	R0x3016
Fine_Integration_Time	R0x3014	R0x3018
Y_Odd_Inc	R0x30A6	R0x30A8
Column Gain	R0x30B0[5:4]	R0x30B0[9:8]
Green1_Gain (GreenR)	R0x3056	R0x30BC
Blue_Gain	R0x3058	R0x30BE
Red_Gain	R0x305A	R0x30C0
Green2_Gain (GreenB)	R0x305C	R0x30C2
Global_Gain	R0x305E	R0x30C4
Frame_Length_Lines	R0x300A	R0x30AA
Digital_Binning	R0x3032[1:0]	R0x3032[5:4]
Operation_Mode_Ctrl	0x3082	0x3084



**FEATURES**

See the MT9M034 Register Reference for additional details.

**Reset**

The MT9M034 may be reset by using RESET\_BAR (active LOW) or the reset register.

*Hard Reset of Logic*

The RESET\_BAR pin can be connected to an external RC circuit for simplicity. The recommended RC circuit uses a 10 kΩ resistor and a 0.1 μF capacitor. The rise time for the RC circuit is 1 μs maximum.

*Soft Reset of Logic*

Soft reset of logic is controlled by the R0x301A Reset register. Bit 0 is used to reset the digital logic of the sensor while preserving the existing two-wire serial interface configuration. Furthermore, by asserting the soft reset, the sensor aborts the current frame it is processing and starts a

new frame. This bit is a self-resetting bit and also returns to “0” during two-wire serial interface reads.

**Clocks**

The MT9M034 requires one clock input (EXTCLK).

*PLL-Generated Master Clock*

The PLL contains a prescaler to divide the input clock applied on EXTCLK, a VCO to multiply the prescaler output, and two divider stages to generate the output clock. The clocking structure is shown in Figure 12. PLL control registers can be programmed to generate desired master clock frequency.

NOTE: The PLL control registers must be programmed while the sensor is in the software Standby state. The effect of programming the PLL divisors while the sensor is in the streaming state is undefined.

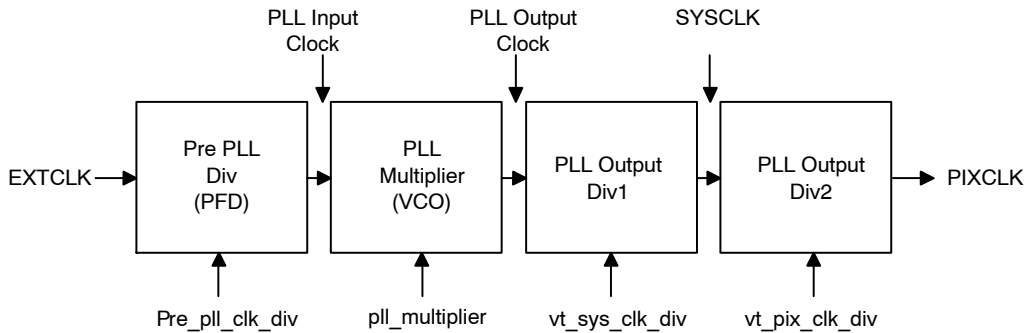

**Figure 12. PLL-Generated Master Clock PLL Setup**

The PLL is enabled by default on the MT9M034. To configure and use the PLL:

1. Bring the MT9M034 up as normal; make sure that  $f_{EXTCLK}$  is between 6 and 50 MHz and ensure the sensor is in software standby (R0x301A-B[2] = 0). PLL control registers must be set in software standby.
2. Set `pll_multiplier`, `pre_pll_clk_div`, `vt_sys_clk_siv`, and `vt_pix_clk_div` based on the desired input ( $f_{EXTCLK}$ ) and output ( $f_{PIXCLK}$ ) frequencies. Determine the M, N, P1, and P2 values to achieve the desired  $f_{PIXCLK}$  using this formula:  

$$f_{PIXCLK} = (f_{EXTCLK} \times M) / (N \times P1 \times P2)$$
 where  
 M = PLL\_Multiplier  
 N = Pre\_PLL\_Clk\_Div  
 P1 = Vt\_Sys\_Clk\_Div  
 P2 = Vt\_PIX\_Clk\_Div
3. Wait 1 ms to ensure that the VCO has locked.

4. Set R0x301A[2] = 1 to enable streaming and to switch from EXTCLK to the PLL-generated clock.

NOTE:

1. The PLL can be bypassed at any time (sensor will run directly off EXTCLK) by setting R0x30B0[14] = 1. The PLL is always bypassed in software standby mode. To disable the PLL, the sensor must be in standby mode (R0x301A[2] = 0)
2. The following restrictions apply to the PLL tuning parameters:  
 $32 \leq M \leq 255$   
 $1 \leq N \leq 63$   
 $1 \leq P1 \leq 16$  (P1 = 1, 2, 3, 4, 6, 8, 10, 12, 14, 16)  
 $4 \leq P2 \leq 16$
3. The VCO frequency, defined as  $f_{VCO} = f_{EXTCLK} \times M / N$  must be within 384–768 MHz.
4. When PLL\_Multiplier is odd,  $2 \text{ MHz} \leq f_{EXTCLK} / N \leq 24 \text{ MHz}$

The user can utilize the Register Wizard tool accompanying DevWare to generate PLL settings given a supplied input clock and desired output frequency.

*Spread–Spectrum Clocking*

To facilitate improved EMI performance, the external clock input allows for spread spectrum sources, with no impact on image quality. Limits of the spread spectrum input clock are:

- 5% maximum clock modulation
- 35 KHz maximum modulation frequency
- Accepts triangle wave modulation, as well as sine or modified triangle modulations.

**Stream/Standby Control**

The sensor supports two standby modes: Hard Standby and Soft Standby. In both modes, external clock can be optionally disabled to further minimize power consumption. If this is done, then the “Power–Up Sequence” must be followed.

*Soft Standby*

Soft Standby is a low power state that is controlled through register R0x301A[2]. Depending on the value of R0x301A[4], the sensor will go to standby after completion of the current frame readout (default behavior) or after the completion of the current row readout. When the sensor comes back from Soft Standby, previously written register settings are still maintained. Soft standby will not occur if the TRIGGER pin is held high.

A specific sequence needs to be followed to enter and exit from Soft Standby.

Entering Soft Standby:

1. Set R0x301A[2] = 0 and drive the TRIGGER pin LOW
2. External clock can be turned off to further minimize power consumption (Optional)

Exiting Soft Standby:

1. Enable external clock if it was turned off
2. R0x301A[2] = 1 or drive the TRIGGER pin HIGH

*Hard Standby*

Hard Standby puts the sensor in lower power state; previously written register settings are still maintained.

A specific sequence needs to be followed to enter and exit from Hard Standby.

Entering Hard Standby:

1. R0x301A[8] = 1
2. Assert STANDBY pin
3. External clock can be turned off to further minimize power consumption (Optional)

Exiting Hard Standby:

1. Enable external clock if it was turned off
2. De–assert STANDBY pin
3. Set R0x301A[8] = 0

**Window Control**

Registers x\_addr\_start, x\_addr\_end, y\_addr\_start, and y\_addr\_end control the size and starting coordinates of the image window.

The exact window height and width out of the sensor is determined by the difference between the Y address start and end registers or the X address start and end registers, respectively.

The MT9M034 allows different window sizes for context A and context B.

**Blanking Control**

Horizontal blank and vertical blank times are controlled by the line\_length\_pck and frame\_length\_lines registers, respectively.

- Horizontal blanking is specified in terms of pixel clocks. It is calculated by subtracting the X window size from the line\_length\_pck register. The minimum horizontal blanking is 370 pixel clocks.
- Vertical blanking is specified in terms of numbers of lines. It is calculated by subtracting the Y window size from the frame\_length\_lines register. The minimum vertical blanking is 26 lines.

The actual imager timing can be calculated using Table 5 and Table 6, which describe the Line Timing and FV/LV signals.

When in HDR mode, the maximum size is 1280 × 960.

**Readout Modes**

*Digital Binning*

By default, the resolution of the output image is the full width and height of the FOV as defined above. The output resolution can be reduced by digital binning. For RGB and monochrome mode, this is set by the register R0x3032. For Context A, use bits [1:0], for Context B, use bits [5:4]. Available settings are:

- 00 = No binning
- 01 = Horizontal binning
- 10 = Horizontal and vertical binning

Binning gives the advantage of reducing noise at the cost of reduced resolution. When both horizontal and vertical binning are used, a 2x improvement in SNR is achieved, therefore improving low light performance. Binning results in a smaller resolution image, but the FOVs between the binned and unbinned images are the same.

*Bayer Space Resampling*

All of the pixels in the FOV contribute to the output image in digital binning mode. This can result in a more pleasing output image with reduced subsampling artifacts. It also improves low–light performance. For RGB mode, resampling can be enabled by setting of register 0x306E[4] = 1.

**Mirror**

*Column Mirror Image*

By setting R0x3040[14] = 1, the readout order of the columns is reversed, as shown in Figure 13. The starting Bayer color pixel is maintained in this mode by a 1-pixel shift in the imaging array.

When using horizontal mirror mode, the user must retrigger column correction. Please refer to the column correction section to see the procedure for column correction retriggering. Bayer resampling must be enabled, by setting bit 4 of register 0x306E[4] = 1.

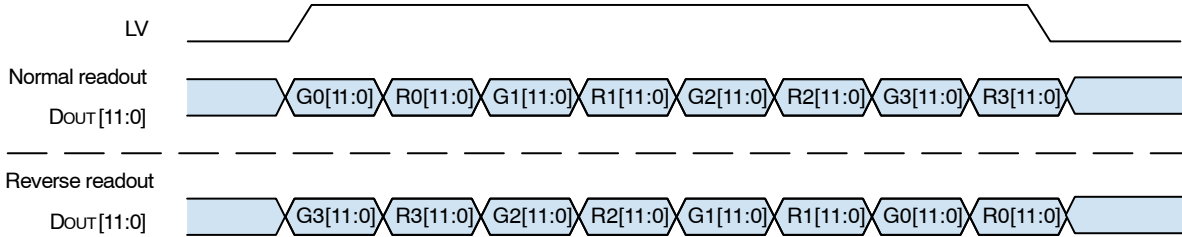
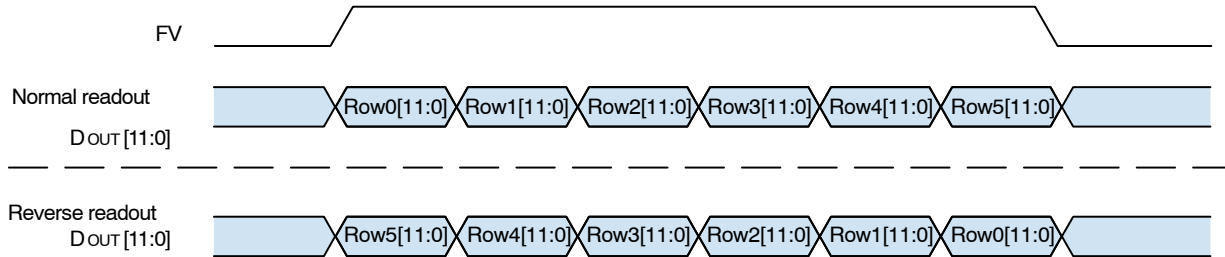

**Figure 13. Eight Pixels in Normal and Column Mirror Readout Modes**

*Row Mirror Image*

By setting R0x3040[15] = 1, the readout order of the rows is reversed as shown in Figure 14. The starting Bayer color pixel is maintained in this mode by a 1-pixel shift in the

imaging array. When using horizontal mirror mode, the user must retrigger column correction. Please refer to the column correction section to see the procedure for column correction retriggering.



**Figure 14. Six Rows in Normal and Row Mirror Readout Modes**

**Maintaining a Constant Frame Rate**

Maintaining a constant frame rate while continuing to have the ability to adjust certain parameters is the desired scenario. This is not always possible, however, because register updates are synchronized to the read pointer, and the shutter pointer for a frame is usually active during the readout of the previous frame. Therefore, any register changes that could affect the row time or the set of rows sampled causes the shutter pointer to start over at the beginning of the next frame.

By default, the following register fields cause a “bubble” in the output rate (that is, the vertical blank increases for one frame) if they are written in video mode, even if the new value would not change the resulting frame rate. The following list shows only a few examples of such registers; a full listing can be seen in the MT9M034 Register Reference.

- x\_addr\_start
- x\_addr\_end
- y\_addr\_start
- y\_addr\_end

- frame\_length\_lines
- line\_length\_pclk
- coarse\_integration\_time
- fine\_integration\_time
- read\_mode

The size of this bubble is (Integration\_Time × t<sub>ROW</sub>), calculating the row time according to the new settings.

The Coarse\_Integration\_Time and Fine\_Integration\_Time fields may be written to without causing a bubble in the output rate under certain circumstances. Because the shutter sequence for the next frame often is active during the output of the current frame, this would not be possible without special provisions in the hardware. Writes to these registers take effect two frames after the frame they are written, which allows the integration time to increase without interrupting the output or producing a corrupt frame (as long as the change in integration time does not affect the frame time).

### Synchronizing Register Writes to Frame Boundaries

Changes to most register fields that affect the size or brightness of an image take effect on two frames after the one during which they are written. These fields are noted as “synchronized to frame boundaries” in the MT9M034 Register Reference. To ensure that a register update takes effect on the next frame, the write operation must be completed after the leading edge of FV and before the trailing edge of FV.

Fields not identified as being frame-synchronized are updated immediately after the register write is completed. The effect of these registers on the next frame can be difficult to predict if they affect the shutter pointer.

### Restart

To restart the MT9M034 at any time during the operation of the sensor, write a “1” to the Restart register (R0x301A[1] = 1). This has two effects: first, the current frame is interrupted immediately. Second, any writes to frame-synchronized registers and the shutter width registers take effect immediately, and a new frame starts (in video mode). The current row completes before the new frame is started, so the time between issuing the Restart and the beginning of the next frame can vary by about  $t_{ROW}$ .

### Image Acquisition Modes

The MT9M034 supports two image acquisition modes: video(master) and single frame.

#### Video

The video mode takes pictures by scanning the rows of the sensor twice. On the first scan, each row is released from reset, starting the exposure. On the second scan, the row is sampled, processed, and returned to the reset state. The exposure for any row is therefore the time between the first and second scans. Each row is exposed for the same duration, but at slightly different point in time, which can cause a shear in moving subjects as is typical with electronic rolling shutter sensors.

#### Single Frame

The single-frame mode operates similar to the video mode. It also scans the rows of the sensor twice, first to reset the rows and second to read the rows. Unlike video mode where a continuous stream of images are output from the image sensor, the single-frame mode outputs a single frame in response to a high state placed on the TRIGGER input pin. As long as the TRIGGER pin is held in a high state, new images will be read out. After the TRIGGER pin is returned to a low state, the image sensor will not output any new images and will wait for the next high state on the TRIGGER pin.

The TRIGGER pin state is detected during the vertical blanking period (i.e. the FV signal is low). The pin is level sensitive rather than edge sensitive. As such, image integration will only begin when the sensor detects that the TRIGGER pin has been held high for three consecutive clock cycles. If the trigger signal is applied to multiple

sensors at the same time, the single frame output of the sensors will be synchronized to within 1 PIXCLK if PLL is disabled or 2 PIXCLKs if PLL is enabled.

During integration time of single-frame mode and video mode, the FLASH output pin is at high.

#### Continuous Trigger

In certain applications, multiple sensors need to have their video streams synchronized (E.g. surround view or panorama view applications). The TRIGGER pin can also be used to synchronize output of multiple image sensors together and still get a video stream. This is called continuous trigger mode. Continuous trigger is enabled by holding the TRIGGER pin high. Alternatively, the TRIGGER pin can be held high until the stream bit is enabled (R0x301A[2] = 1) then can be released for continuous synchronized video streaming.

If the TRIGGER pins for all connected MT9M034 sensors are connected to the same control signal, all sensors will receive the trigger pulse at the same time. If they are configured to have the same frame timing, then the usage of the TRIGGER pin guarantees that all sensors will be synchronized within 1 PIXCLK cycle if PLL is disabled, or 2 PIXCLK cycles if PLL is enabled.

With continuous trigger mode, the application can now make use of the video streaming mode while guaranteeing that all sensor outputs are synchronized. As long as the initial trigger for the sensors takes place at the same time, all subsequent video streams will be synchronous.

### Temperature Sensor

The MT9M034 sensor has a built-in PTAT-based temperature sensor, accessible through registers, that is capable of measuring die junction temperature.

The temperature sensor can be enabled by writing R0x30B4[0] = 1 and R0x30B4[4] = 1. After this, the temperature sensor output value can be read from R0x30B2[10:0].

The value read out from the temperature sensor register is an ADC output value that needs to be converted downstream to a final temperature value in degrees Celsius. Since the PTAT device characteristic response is quite linear in the temperature range of operation required, a simple linear function in the format of listed in the equation below can be used to convert the ADC output value to the final temperature in degrees Celsius.

$$\text{Temperature} = \text{slope} \times \text{R0x30B2}[10:0] + T_0 \quad (\text{eq. 5})$$

For this conversion, a minimum of 2 known points are needed to construct the line formula by identifying the slope and y-intercept “ $T_0$ ”. These calibration values can be read from registers R0x30C6 and R0x30C8 which correspond to value read at 70°C and 55°C respectively. Once read, the slope and y-intercept values can be calculated and used in the above equation.

For more information on the temperature sensor registers, refer to the MT9M034 Register Reference.

**Automatic Exposure Control**

The integrated automatic exposure control (AEC) is responsible for ensuring that optimal settings of exposure and gain are computed and updated every other frame. AEC can be enabled or disabled by R0x3100[0].

When AEC is disabled (R0x3100[0] = 0), the sensor uses the manual exposure value in coarse and fine shutter width registers and the manual gain value in the gain registers.

When AEC is enabled (R0x3100[0] = 1), the target luma value in linear mode is set by R0x3102. For the MT9M034 this target luma has a default value of 0x0800 or about half scale. For HDR mode, the luma target maximum auto exposure value is limited by R0x311C; the minimum auto exposure is limited by R0x311E. These values are in units of line-times.

The exposure control measures current scene luminosity by accumulating a histogram of pixel values while reading out a frame. It then compares the current luminosity to the desired output luminosity. Finally, the appropriate adjustments are made to the exposure time and gain. All pixels are used, regardless of color or mono mode. In HDR

mode, the coarse and fine integration time is the longest integration time of the three integration, the other two shorter integration are generated automatically base on the pre-defined exposure ratios. When using non-default HDR exposure ratios, auto\_dg\_en should not be enabled (R0x3100[4] = 0) due to required digital gains as documented in Table 9.

**Embedded Data and Statistics**

The MT9M034 has the capability to output image data and statistics embedded within the frame timing. There are 2 types of information embedded within the frame readout:

1. Embedded Data: If enabled, these are displayed on the 2 rows immediately before the first active pixel row is displayed
2. Embedded Statistics: If enabled, these are displayed on the two rows immediately after the last active pixel row is displayed

NOTE: Embedded data and embedded statistics must be enabled or disabled together.

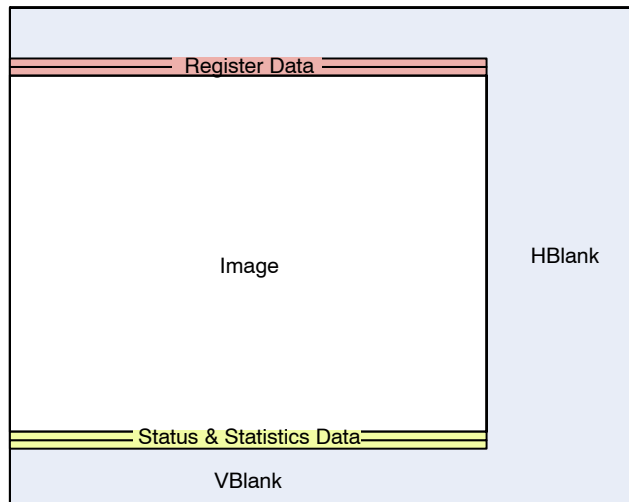

**Figure 15. Frame Format with Embedded Data Lines Enabled**

*Embedded Data*

The embedded data contains the configuration of the image being displayed. This includes all register settings used to capture the current frame. The registers embedded in these rows are as follows:

Line 1:

Registers R0x3000 to R0x312F

Line 2:

Registers R0x3136 to R0x31BF, R0x31D0 to R0x31FF

NOTE: All non-defined registers will have a value of 0.

In parallel mode, since the pixel word depth is 12-bits/pixel, the sensor 16-bit register data will be transferred over two pixels where the register data will be broken up into eight msb and eight lsb. The alignment of the 8 bit data will be on the 8MSB bits of the 12-bit pixel word. For example, if a register value of 0x1234 is to be transmitted, it will be transmitted over 2, 12-bit pixels as follows: 0x120, 0x340.

The first pixel of each line in the embedded data is a tag value of 0x0A0. This signifies that all subsequent data is 8 bit data aligned to the MSB of the 12-bit pixel.

The figure below summarizes how the embedded data transmission looks like. It should be noted that data, as shown in Figure 16, is aligned to the MSB of each word:

# MT9M034

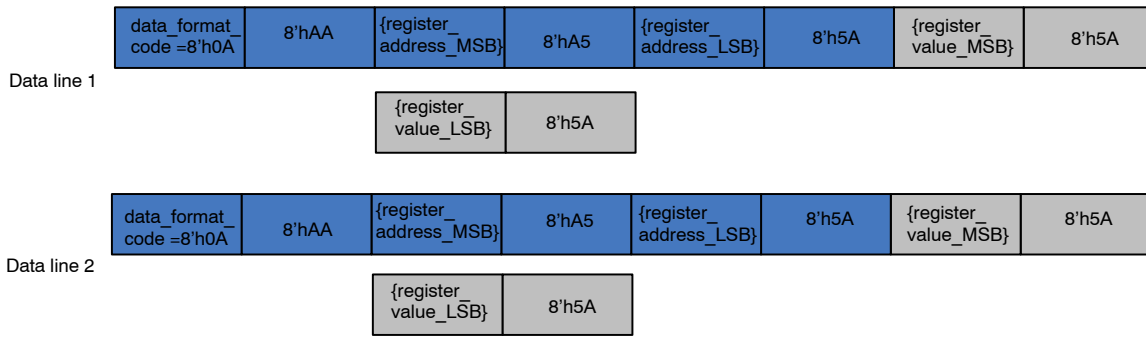

**Figure 16. Format of Embedded Data Output within a Frame**

The data embedded in these rows are as follows:

- 0x0A0 – identifier
- 0xAA0
- Register Address MSB of the first register
- 0xA50
- Register Address LSB of the first register
- 0x5A0
- Register Value MSB of the first register addressed
- 0x5A0
- Register Value LSB of the first register addressed
- 0x5A0
- Register Value MSB of the register at first address + 2
- 0x5A0
- Register Value LSB of the register at first address + 2
- 0x5A0
- etc.

### Embedded Statistics

The embedded statistics contain frame identifiers and histogram information of the image in the frame. This can be used by downstream auto-exposure algorithm blocks to make decisions about exposure adjustment.

This histogram is divided into 244 bins with a bin spacing of 64 evenly spaced bins for digital code values 0 to  $2^{12}$ , 120 evenly spaced bins for values  $2^{12}$  to  $2^{16}$ , 60 evenly spaced bins for values  $2^{16}$  to  $2^{20}$ . In HDR with a 16x exposure ratio, this approximately corresponds to the T1, T2, T3 exposures respectively.

The first pixel of each line in the embedded statistics is a tag value of 0x0B0. This signifies that all subsequent statistics data is 10 bit data aligned to the MSB of the 12-bit pixel.

The figure below summarizes how the embedded statistics transmission looks like. It should be noted that data, as shown in Figure 17, is aligned to the msb of each word:

statsline1

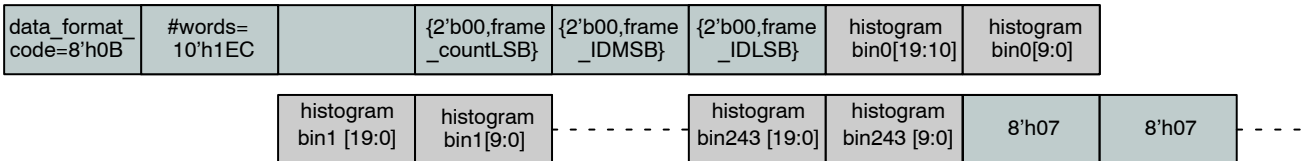

statsline2

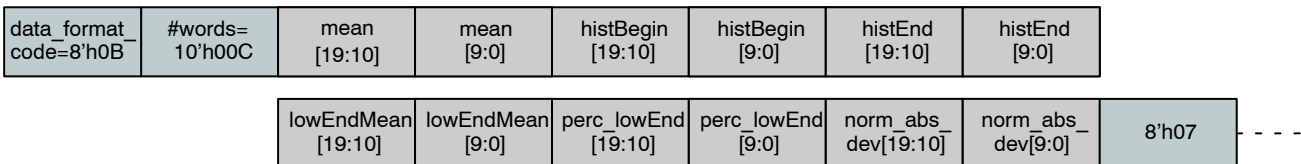

**Figure 17. Format of Embedded Statistics Output within a Frame**

The statistics embedded in these rows are as follows:

Line 1:

- 0x0B0 – (identifier)
- Register 0x303A – frame\_count
- Register 0x31D2 – frame ID
- Histogram data – histogram bins 0–243

Line 2:

- 0x0B0 (identifier)
- Mean
- Histogram Begin
- Histogram End
- Low End Histogram Mean
- Percentage of Pixels Below Low End Mean
- Normal Absolute Deviation

## Gain

### Digital Gain

Digital gain can be controlled globally by R0x305E (Context A) or R0x30C4 (Context B). There are also registers that allow individual control over each Bayer color (GreenR, GreenB, Red, Blue).

The format for digital gain setting is xxx.yyyyy where 0b00100000 represents a 1x gain setting and 0b00110000 represents a 1.5x gain setting. The step size for yyyyy is 0.03125 while the step size for xxx is 1. Therefore to set a gain of 2.09375 one would set digital gain to 01000011.

### Analog Gain

The MT9M034 has a column parallel architecture and therefore has an Analog gain stage per column.

There are 2 stages of analog gain, the first stage can be set to 1x, 2x, 4x or 8x. This can be set in R0x30B0[5:4] (Context A) or R0x30B0[9:8] (Context B). The second stage is capable of setting an additional 1x or 1.25x gain which can be set in R0x3EE4[9:8].

This allows the maximum possible analog gain to be set to 10x.

## Black Level Correction

Black level correction is handled automatically by the image sensor. No adjustments are provided except to enable or disable this feature. Setting R0x30EA[15] disables the automatic black level correction. Default setting is for automatic black level calibration to be enabled.

The automatic black level correction measures the average value of pixels from a set of optically black lines in the image sensor. The pixels are averaged as if they were light-sensitive and passed through the appropriate gain. This line average is then digitally low-pass filtered over many frames to remove temporal noise and random instabilities associated with this measurement. The new filtered average is then compared to a minimum acceptable level, low threshold, and a maximum acceptable level, high threshold. If the average is lower than the minimum acceptable level, the offset correction value is increased by

a predetermined amount. If it is above the maximum level, the offset correction value is decreased by a predetermined amount. The high and low thresholds have been calculated to avoid oscillation of the black level from below to above the targeted black level.

## Row-wise Noise Correction

Row (Line)-wise Noise Correction is handled automatically by the image sensor. No adjustments are provided except to enable or disable this feature. Clearing R0x3044[10] disables the row noise correction. Default setting is for row noise correction to be enabled.

Row-wise noise correction is performed by calculating an average from a set of optically black pixels at the start of each line and then applying each average to all the active pixels of the line.

## Column Correction

The MT9M034 uses column parallel readout architecture to achieve fast frame rate. Without any corrections, the consequence of this architecture is that different column signal paths have slightly different offsets that might show up on the final image as structured fixed pattern noise.

MT9M034 has column correction circuitry that measures this offset and removes it from the image before output. This is done by sampling dark rows containing tied pixels and measuring an offset coefficient per column to be corrected later in the signal path.

Column correction can be enabled/disabled via R0x30D4[15]. Additionally, the number of rows used for this offset coefficient measurement is set in R0x30D4[3:0]. By default this register is set to 0x7, which means that 8 rows are used. This is the recommended value. Other control features regarding column correction can be viewed in the MT9M034 Register reference. Any changes to column correction settings need to be done when the sensor streaming is disabled and the appropriate triggering sequence must be followed as described below.

### Column Correction Triggering

Column correction requires a special procedure to trigger depending on which state the sensor is in.

#### Column Triggering on Startup

When streaming the sensor for the first time after powerup, a special sequence needs to be followed to make sure that the column correction coefficients are internally calculated properly.

1. Follow proper power up sequence for power supplies and clocks
2. Apply sequencer settings if needed (Linear or HDR mode)
3. Apply frame timing and PLL settings as required by application
4. Set analog gain to 1x and low conversion gain (R0x30B0 = 0x1300)
5. Enable column correction and settings (R0x30D4 = 0xE007)

6. Disable auto-re-trigger for change in conversion gain or col\_gain, and enable column correction always (R0x30BA = 0x0008)
7. Enable streaming (R0x301A[2] = 1) or drive the TRIGGER pin HIGH
8. Wait nine frames to settle (First frame after coming up from standby is internally column correction disabled)
9. Disable streaming (R0x301A[2] = 0)

After this, the sensor has calculated the proper column correction coefficients and the sensor is ready for streaming. Any other settings (including gain, integration time and conversion gain etc.) can be done afterwards without affecting column correction.

**Column Correction Retriggering Due to Mode Change**

Since column offsets is sensitive to changes in the analog signal path, such changes require column correction circuitry to be retriggered for the new path. Examples of such mode changes include: horizontal mirror, vertical mirror, changes to column correction settings.

When such changes take place, the following sequence needs to take place:

1. Disable streaming (R0x301A[2] = 0) or drive the TRIGGER pin LOW
2. Enable streaming (R0x301A[2] = 1) or drive the TRIGGER pin HIGH
3. Wait nine frames to settle

**NOTE:** The above steps are not needed if the sensor is being reset (soft or hard reset) upon the mode change.

**Defective Pixel Correction**

Defective Pixel Correction is intended to compensate for defective pixels by replacing their value with a value based

on the surrounding pixels, making the defect less noticeable to the human eye. The defect pixel correction feature supports up to 200 defects. The locations of defective pixels are stored in a table on chip during the manufacturing process; this table is accessible through the two-wire serial interface. There is no provision for later augmenting the defect table entries.

The DPC algorithm is one-dimensional, calculating the resulting averaged pixel value based on nearby pixels within a row. The algorithm distinguishes between color and monochrome parts; for color parts, the algorithm uses nearest neighbor in the same color plane.

At high gain, long exposure, and high temperature conditions, the performance of this function can degrade.

**Test Patterns**

The MT9M034 has the capability of injecting a number of test patterns into the top of the datapath to debug the digital logic. With one of the test patterns activated, any of the datapath functions can be enabled to exercise it in a deterministic fashion. Test patterns are selected by Test\_Pattern\_Mode register (R0x3070). Only one of the test patterns can be enabled at a given point in time by setting the Test\_Pattern\_Mode register according to Table 11. When test patterns are enabled the active area will receive the value specified by the selected test pattern and the dark pixels will receive the value in Test\_Pattern\_Green (R0x3074 and R0x3078) for green pixels, Test\_Pattern\_Blue (R0x3076) for blue pixels, and Test\_Pattern\_Red (R0x3072) for red pixels.

**NOTE:** Turn off black level calibration (BLC) when Test Pattern is enabled.

**Table 11. TEST PATTERN MODES**

Test_Pattern_Mode	Test Pattern Output
0	No test pattern (normal operation)
1	Solid color test pattern
2	100% color bar test pattern
3	Fade-to-gray color bar test pattern
256	Walking 1s test pattern (12-bit)

*Color Field*

When the color field mode is selected, the value for each pixel is determined by its color. Green pixels will receive the value in Test\_Pattern\_Green, red pixels will receive the value in Test\_Pattern\_Red, and blue pixels will receive the value in Test\_Pattern\_Blue.

*Vertical Color Bars*

When the vertical color bars mode is selected, a typical color bar pattern will be sent through the digital pipeline.

*Walking 1s*

When the walking 1s mode is selected, a walking 1s pattern will be sent through the digital pipeline. The first value in each row is 1.



## TWO-WIRE SERIAL REGISTER INTERFACE

The two-wire serial interface bus enables read/write access to control and status registers within the MT9M034.

The interface protocol uses a master/slave model in which a master controls one or more slave devices. The sensor acts as a slave device. The master generates a clock (SCLK) that is an input to the sensor and is used to synchronize transfers. Data is transferred between the master and the slave on a bidirectional signal (SDATA). SDATA is pulled up to  $V_{DD\_IO}$  off-chip by a 1.5 k $\Omega$  resistor. Either the slave or master device can drive SDATA LOW—the interface protocol determines which device is allowed to drive SDATA at any given time.

The protocols described in the two-wire serial interface specification allow the slave device to drive SCLK LOW; the MT9M034 uses SCLK as an input only and therefore never drives it LOW.

### Protocol

Data transfers on the two-wire serial interface bus are performed by a sequence of low-level protocol elements:

1. a (repeated) start condition
2. a slave address/data direction byte
3. an (a no) acknowledge bit
4. a message byte
5. a stop condition

The bus is idle when both SCLK and SDATA are HIGH. Control of the bus is initiated with a start condition, and the bus is released with a stop condition. Only the master can generate the start and stop conditions.

#### Start Condition

A start condition is defined as a HIGH-to-LOW transition on SDATA while SCLK is HIGH. At the end of a transfer, the master can generate a start condition without previously generating a stop condition; this is known as a “repeated start” or “restart” condition.

#### Stop Condition

A stop condition is defined as a LOW-to-HIGH transition on SDATA while SCLK is HIGH.

#### Data Transfer

Data is transferred serially, 8 bits at a time, with the MSB transmitted first. Each byte of data is followed by an acknowledge bit or a no-acknowledge bit. This data transfer mechanism is used for the slave address/data direction byte and for message bytes.

One data bit is transferred during each SCLK clock period. SDATA can change when SCLK is LOW and must be stable while SCLK is HIGH.

#### Slave Address/Data Direction Byte

Bits [7:1] of this byte represent the device slave address and bit [0] indicates the data transfer direction. A “0” in bit [0] indicates a WRITE, and a “1” indicates a READ. The

default slave addresses used by the MT9M034 are 0x20 (write address) and 0x21 (read address) in accordance with the specification. Alternate slave addresses of 0x30 (write address) and 0x31 (read address) can be selected by enabling and asserting the SADDR input.

An alternate slave address can also be programmed through R0x31FC.

#### Message Byte

Message bytes are used for sending register addresses and register write data to the slave device and for retrieving register read data.

#### Acknowledge Bit

Each 8-bit data transfer is followed by an acknowledge bit or a no-acknowledge bit in the SCLK clock period following the data transfer. The transmitter (which is the master when writing, or the slave when reading) releases SDATA. The receiver indicates an acknowledge bit by driving SDATA LOW. As for data transfers, SDATA can change when SCLK is LOW and must be stable while SCLK is HIGH.

#### No-Acknowledge Bit

The no-acknowledge bit is generated when the receiver does not drive SDATA LOW during the SCLK clock period following a data transfer. A no-acknowledge bit is used to terminate a read sequence.

### Typical Sequence

A typical READ or WRITE sequence begins by the master generating a start condition on the bus. After the start condition, the master sends the 8-bit slave address/data direction byte. The last bit indicates whether the request is for a read or a write, where a “0” indicates a write and a “1” indicates a read. If the address matches the address of the slave device, the slave device acknowledges receipt of the address by generating an acknowledge bit on the bus.

If the request was a WRITE, the master then transfers the 16-bit register address to which the WRITE should take place. This transfer takes place as two 8-bit sequences and the slave sends an acknowledge bit after each sequence to indicate that the byte has been received. The master then transfers the data as an 8-bit sequence; the slave sends an acknowledge bit at the end of the sequence. The master stops writing by generating a (re)start or stop condition.

If the request was a READ, the master sends the 8-bit write slave address/data direction byte and 16-bit register address, the same way as with a WRITE request. The master then generates a (re)start condition and the 8-bit read slave address/data direction byte, and clocks out the register data, eight bits at a time. The master generates an acknowledge bit after each 8-bit transfer. The slave’s internal register address is automatically incremented after every 8 bits are transferred. The data transfer is stopped when the master sends a no-acknowledge bit.

# MT9M034

## Single READ from Random Location

This sequence (Figure 18) starts with a dummy WRITE to the 16-bit address that is to be used for the READ. The master terminates the WRITE by generating a restart condition. The master then sends the 8-bit read slave address/data direction byte and clocks out one byte of

register data. The master terminates the READ by generating a no-acknowledge bit followed by a stop condition. Figure 18 shows how the internal register address maintained by the MT9M034 is loaded and incremented as the sequence proceeds.

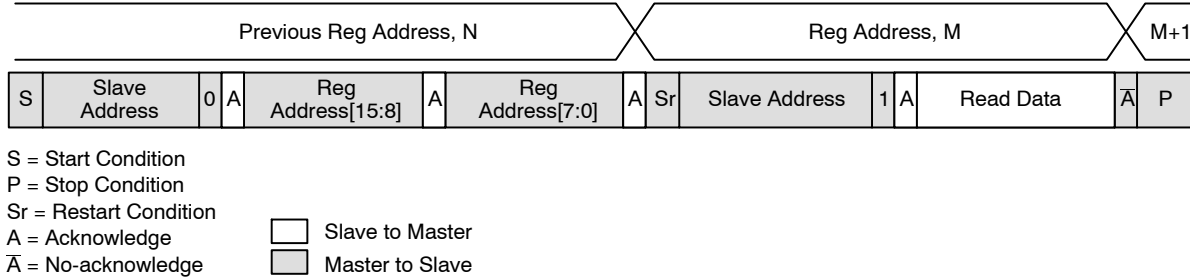

Figure 18. Single READ from Random Location

## Single READ From Current Location

This sequence (Figure 19) performs a read using the current value of the MT9M034 internal register address. The

master terminates the READ by generating a no-acknowledge bit followed by a stop condition. The figure shows two independent READ sequences.

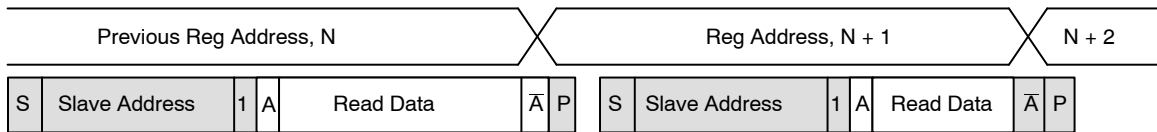

Figure 19. Single READ from Current Location

## Sequential READ, Start From Random Location

This sequence (Figure 20) starts in the same way as the single READ from random location (Figure 18). Instead of generating a no-acknowledge bit after the first byte of data

has been transferred, the master generates an acknowledge bit and continues to perform byte READs until “L” bytes have been read.

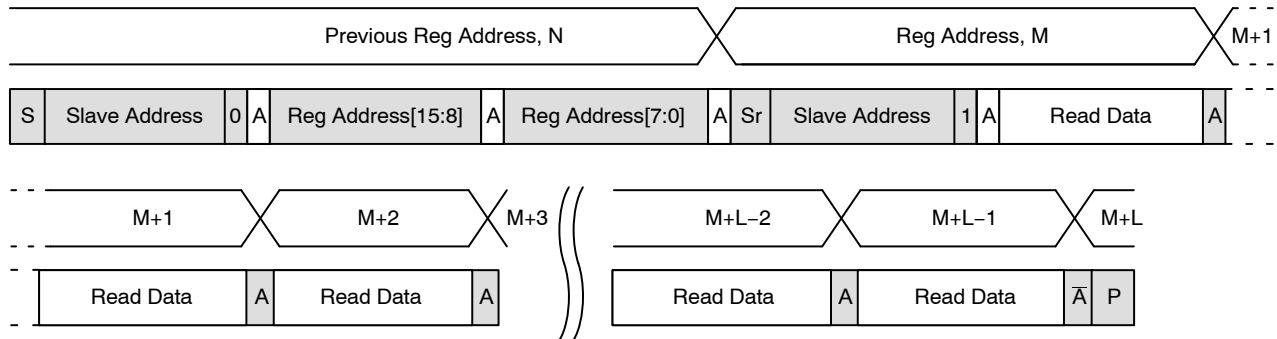

Figure 20. Sequential READ, Start from Random Location



SPECTRAL CHARACTERISTICS

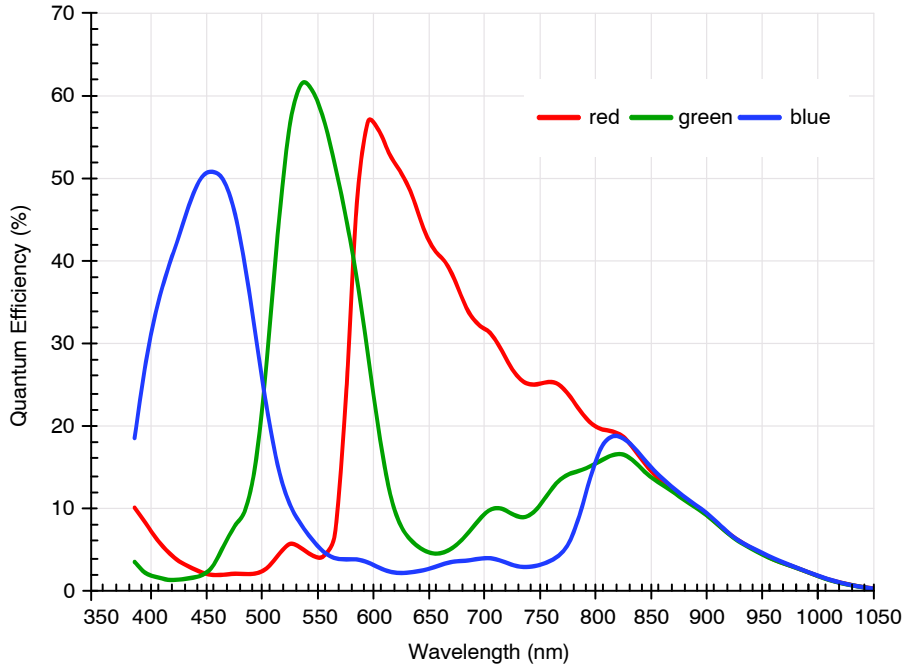

Figure 24. Quantum Efficiency – Color Sensor

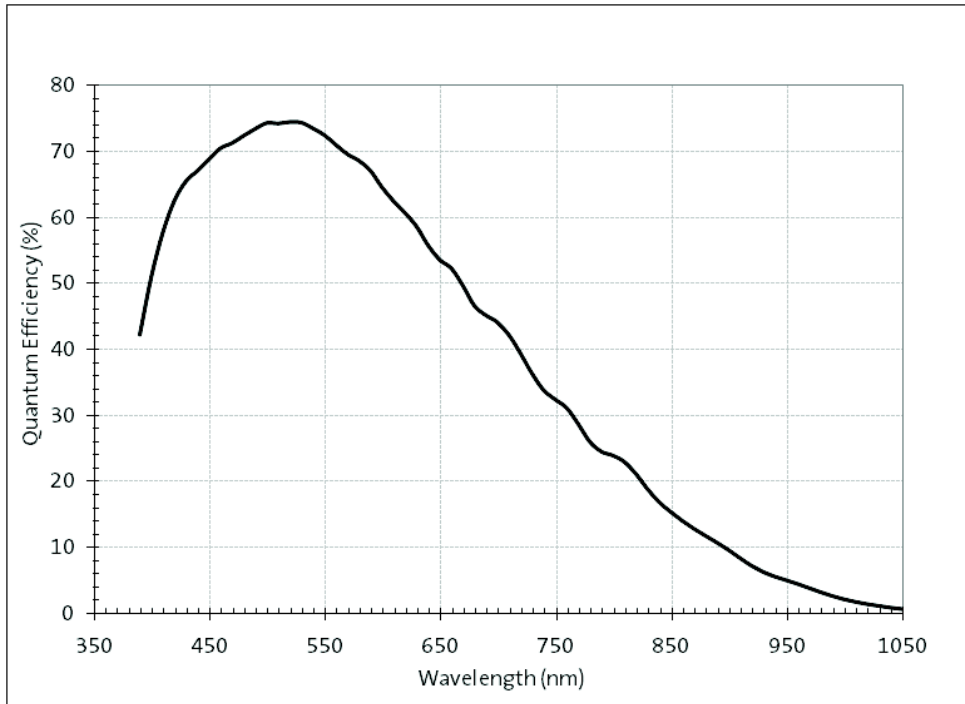

Figure 25. Estimated Quantum Efficiency – Monochrome Sensor

**ELECTRICAL SPECIFICATIONS**

Unless otherwise stated, the following specifications apply to the following conditions:  
 $V_{DD} = 1.8\text{ V} - 0.10 / +0.15$ ;  $V_{DD\_IO} = V_{DD\_PLL} = V_{AA} = V_{AA\_PIX} = 2.8\text{ V} \pm 0.3\text{ V}$ ;  
 $T_A = -30^\circ\text{C}$  to  $+70^\circ\text{C}$ ; output load = 10 pF; frequency = 74.25 MHz.

**Two-Wire Serial Register Interface**

The electrical characteristics of the two-wire serial register interface (SCLK, S<sub>DATA</sub>) are shown in Figure 26 and Table 12.

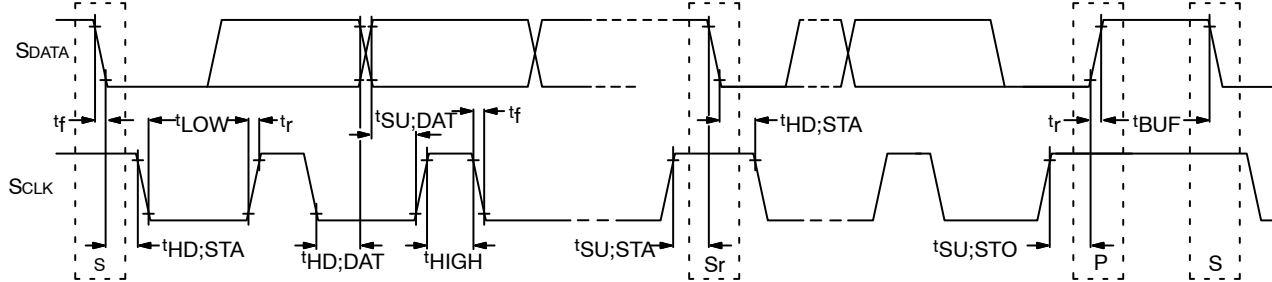

Note: Read sequence: For an 8-bit READ, read waveforms start after WRITE command and register address are issued.

**Figure 26. Two-Wire Serial Bus Timing Parameters**

**Table 12. TWO-WIRE SERIAL BUS CHARACTERISTICS**

$f_{EXTCLK} = 27\text{ MHz}$ ;  $V_{DD} = 1.8\text{ V}$ ;  $V_{DD\_IO} = 2.8\text{ V}$ ;  $V_{AA} = 2.8\text{ V}$ ;  $V_{AA\_PIX} = 2.8\text{ V}$ ;  $V_{DD\_PLL} = 2.8\text{ V}$ ;  $V_{DD\_DAC} = 2.8\text{ V}$ ;  $T_A = 25^\circ\text{C}$

Parameter	Symbol	Standard-Mode		Fast-Mode		Unit
		Min	Max	Min	Max	
SCLK Clock Frequency	$f_{SCL}$	0	100	0	400	kHz
Hold Time (Repeated) START Condition						
After this Period, the First Clock Pulse is Generated	$t_{HD;STA}$	4.0	–	0.6	–	$\mu\text{s}$
LOW Period of the SCLK Clock	$t_{LOW}$	4.7	–	1.3	–	$\mu\text{s}$
HIGH Period of the SCLK Clock	$t_{HIGH}$	4.0	–	0.6	–	$\mu\text{s}$
Set-up Time for a Repeated START Condition	$t_{SU;STA}$	4.7	–	0.6	–	$\mu\text{s}$
Data Hold Time	$t_{HD;DAT}$	0 (Note 5)	3.45 (Note 6)	0 (Note 7)	0.9 (Note 6)	$\mu\text{s}$
Data Set-up Time	$t_{SU;DAT}$	250	–	100 <sup>6</sup>	–	ns
Rise Time of Both S <sub>DATA</sub> and SCLK Signals	$t_r$	–	1000	20 + 0.1Cb (Note 8)	300	ns
Fall Time of Both S <sub>DATA</sub> and SCLK Signals	$t_f$	–	300	20 + 0.1Cb (Note 8)	300	ns
Set-up Time for STOP Condition	$t_{SU;STO}$	4.0	–	0.6	–	$\mu\text{s}$
Bus Free Time between a STOP and START Condition	$t_{BUF}$	4.7	–	1.3	–	$\mu\text{s}$
Capacitive Load for Each Bus Line	C <sub>b</sub>	–	400	–	400	pF
Serial Interface Input pin Capacitance	C <sub>IN_SI</sub>	–	3.3	–	3.3	pF
S <sub>DATA</sub> Max Load Capacitance	C <sub>LOAD_SD</sub>	–	30	–	30	pF
S <sub>DATA</sub> Pull-up Resistor	R <sub>SD</sub>	1.5	4.7	1.5	4.7	k $\Omega$

- This table is based on I<sup>2</sup>C standard (v2.1 January 2000). onsemi.
- Two-wire control is I<sup>2</sup>C-compatible.
- All values referred to  $V_{IHmin} = 0.9 V_{DD}$  and  $V_{ILmax} = 0.1 V_{DD}$  levels. Sensor EXCLK = 27 MHz.
- A device must internally provide a hold time of at least 300 ns for the S<sub>DATA</sub> signal to bridge the undefined region of the falling edge of SCLK.
- The maximum  $t_{HD;DAT}$  has only to be met if the device does not stretch the LOW period ( $t_{LOW}$ ) of the SCLK signal.
- A Fast-mode I<sup>2</sup>C-bus device can be used in a Standard-mode I<sup>2</sup>C-bus system, but the requirement  $t_{SU;DAT}$  250 ns must then be met. This will automatically be the case if the device does not stretch the LOW period of the SCLK signal. If such a device does stretch the LOW period of the SCLK signal, it must output the next data bit to the S<sub>DATA</sub> line  $t_r \text{ max} + t_{SU;DAT} = 1000 + 250 = 1250\text{ ns}$  (according to the Standard-mode I<sup>2</sup>C-bus specification) before the SCLK line is released.
- C<sub>b</sub> = total capacitance of one bus line in pF.

# MT9M034

## I/O Timing

By default, the MT9M034 launches pixel data, FV, and LV with the falling edge of PIXCLK. The expectation is that the user captures DOUT[11:0], FV, and LV using the rising edge of PIXCLK. This can be changed using register R0x3028.

See Figure 27 and Table 13 for I/O timing (AC) characteristics.

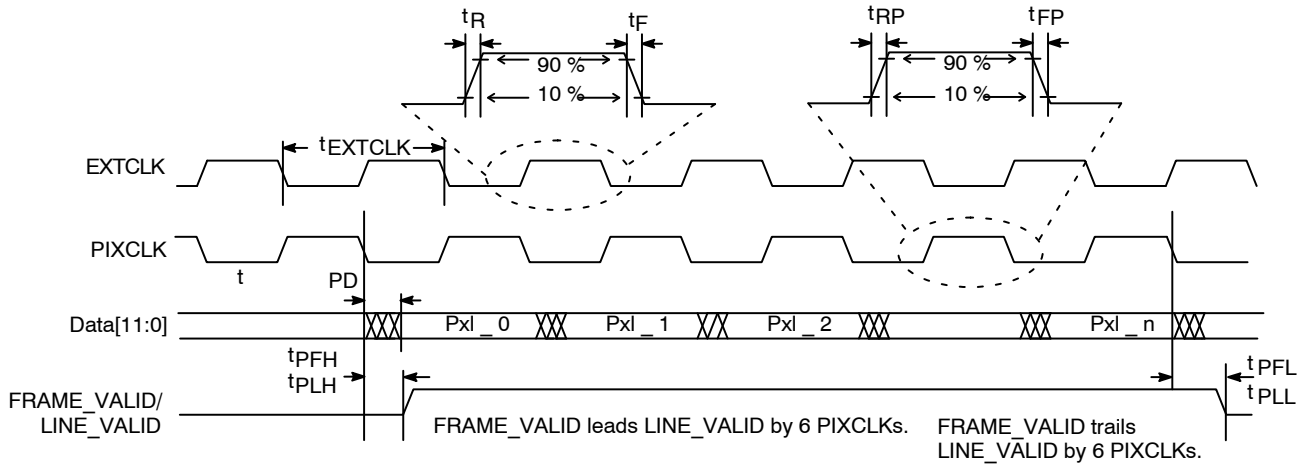

Figure 27. I/O Timing Diagram

Table 13. I/O TIMING CHARACTERISTICS (2.8 V VDD\_IO) (Note 9)

Symbol	Definition	Condition	Min	Typ	Max	Unit
f <sub>EXTCLK</sub>	Input Clock Frequency		6	–	50	MHz
t <sub>EXTCLK</sub>	Input Clock Period		20	–	166	ns
t <sub>R</sub>	Input Clock Rise Time		–	3	–	ns
t <sub>F</sub>	Input Clock Fall Time		–	3	–	ns
t <sub>JITTER</sub>	Input Clock Jitter		–	–	600	ps
t <sub>RP</sub>	Pixclk Rise Time	PCLK slew rate = 6	1.2	–	2.9	ns
t <sub>FP</sub>	Pixclk Fall Time	PCLK slew rate = 6	1.2	–	2.9	ns
	Pixclk Duty Cycle		45	50	55	%
f <sub>PIXCLK</sub>	PIXCLK Frequency (Note 10)		6	–	74.25	MHz
t <sub>PD</sub>	PIXCLK to Data Valid	PCLK slew rate = 6, Parallel slew rate = 7	–2	–	2.5	ns
t <sub>PFH</sub>	PIXCLK to FV HIGH	PCLK slew rate = 6, Parallel slew rate = 7	–2	–	2.5	ns
t <sub>PLH</sub>	PIXCLK to LV HIGH	PCLK slew rate = 6, Parallel slew rate = 7	–2	–	2.5	ns
t <sub>PFL</sub>	PIXCLK to FV LOW	PCLK slew rate = 6, Parallel slew rate = 7	–2	–	2.5	ns
t <sub>PLL</sub>	PIXCLK to LV LOW	PCLK slew rate = 6, Parallel slew rate = 7	–2	–	2.5	ns

9. Minimum and maximum values are taken at the temperature and voltage limits; for instance, 70°C at 2.5 V, and –30°C at 3.1 V. All values are taken at the 50% transition point. The loading used is 10 pF.

10. Jitter from PIXCLK is already taken into account as the data of all the output parameters.

# MT9M034

**Table 14. I/O TIMING CHARACTERISTICS (1.8 V VDD\_IO) (Note 11)**

Symbol	Definition	Condition	Min	Typ	Max	Unit
f <sub>EXTCLK</sub>	Input Clock Frequency		6	–	50	MHz
t <sub>EXTCLK</sub>	Input Clock Period		20	–	166	ns
t <sub>R</sub>	Input Clock Rise Time		–	3	–	ns
t <sub>F</sub>	Input Clock Fall Time		–	3	–	ns
t <sub>JITTER</sub>	Input Clock Jitter		–	–	600	ps
t <sub>RP</sub>	Pixel Rise Time	PCLK slew rate = 6	1.8	–	4.8	ns
t <sub>FP</sub>	Pixel Fall Time	PCLK slew rate = 6	1.7	–	4.5	ns
	Pixel Duty Cycle		45	50	55	%
f <sub>PIXCLK</sub>	PIXCLK Frequency (Note 12)		6		74.25	MHz
t <sub>PD</sub>	PIXCLK to Data Valid	PCLK slew rate = 6, Parallel slew rate = 7	–2.5	–	2	ns
t <sub>PFH</sub>	PIXCLK to FV HIGH	PCLK slew rate = 6, Parallel slew rate = 7	–2.5	–	2	ns
t <sub>PLH</sub>	PIXCLK to LV HIGH	PCLK slew rate = 6, Parallel slew rate = 7	–2.5	–	2	ns
t <sub>PFL</sub>	PIXCLK to FV LOW	PCLK slew rate = 6, Parallel slew rate = 7	–2.5	–	2	ns
t <sub>PLL</sub>	PIXCLK to LV LOW	PCLK slew rate = 6, Parallel slew rate = 7	–2.5	–	2	ns

11. Minimum and maximum values are taken at the temperature and voltage limits; for instance, 70°C at 1.7 V, and –30°C at 1.95 V. All values are taken at the 50% transition point. The loading used is 10 pF.

12. Jitter from PIXCLK is already taken into account as the data of all the output parameters.

**Table 15. I/O RISE SLEW RATE (2.8 V VDD\_IO) (Note 13)**

Parallel Slew Rate (R0x306E[15:13])	Conditions	Min	Typ	Max	Unit
7	Default	1.08	1.77	2.72	V/ns
6	Default	0.77	1.26	1.94	V/ns
5	Default	0.58	0.95	1.46	V/ns
4	Default	0.44	0.70	1.08	V/ns
3	Default	0.32	0.51	0.78	V/ns
2	Default	0.23	0.37	0.56	V/ns
1	Default	0.16	0.25	0.38	V/ns
0	Default	0.10	0.15	0.22	V/ns

13. Minimum and maximum values are taken at the temperature and voltage limits; for instance, 70°C at 2.5 V, and –30°C at 3.1 V. The loading used is 10 pF.

**Table 16. I/O FALL SLEW RATE (2.8 V VDD\_IO) (Note 14)**

Parallel Slew Rate (R0x306E[15:13])	Conditions	Min	Typ	Max	Unit
7	Default	1.00	1.62	2.41	V/ns
6	Default	0.76	1.24	1.88	V/ns
5	Default	0.60	0.98	1.50	V/ns
4	Default	0.46	0.75	1.16	V/ns
3	Default	0.35	0.56	0.86	V/ns
2	Default	0.25	0.40	0.61	V/ns
1	Default	0.17	0.27	0.41	V/ns
0	Default	0.11	0.16	0.24	V/ns

14. Minimum and maximum values are taken at the temperature and voltage limits; for instance, 70°C at 2.5 V, and –30°C at 3.1 V. The loading used is 10 pF.

# MT9M034

**Table 17. I/O RISE SLEW RATE (1.8 V VDD\_IO) (Note 15)**

Parallel Slew Rate (R0x306E[15:13])	Conditions	Min	Typ	Max	Unit
7	Default	0.41	0.65	1.10	V/ns
6	Default	0.30	0.47	0.79	V/ns
5	Default	0.24	0.37	0.61	V/ns
4	Default	0.19	0.28	0.46	V/ns
3	Default	0.14	0.21	0.34	V/ns
2	Default	0.10	0.15	0.24	V/ns
1	Default	0.07	0.10	0.16	V/ns
0	Default	0.04	0.06	0.10	V/ns

15. Minimum and maximum values are taken at the temperature and voltage limits; for instance, 70°C at 1.7 V, and –30°C at 1.95 V. The loading used is 10 pF.

**Table 18. I/O FALL SLEW RATE (1.8 V VDD\_IO) (Note 16)**

Parallel Slew Rate (R0x306E[15:13])	Conditions	Min	Typ	Max	Unit
7	Default	0.42	0.68	1.11	V/ns
6	Default	0.32	0.51	0.84	V/ns
5	Default	0.26	0.41	0.67	V/ns
4	Default	0.20	0.32	0.52	V/ns
3	Default	0.16	0.24	0.39	V/ns
2	Default	0.12	0.18	0.28	V/ns
1	Default	0.08	0.12	0.19	V/ns
0	Default	0.05	0.07	0.11	V/ns

16. Minimum and maximum values are taken at the temperature and voltage limits; for instance, 70°C at 1.7 V, and –30°C at 1.95 V. The loading used is 10 pF.



**DC ELECTRICAL CHARACTERISTICS**

The DC electrical characteristics are shown in the tables below.

**Table 19. DC ELECTRICAL CHARACTERISTICS**

Symbol	Definition	Condition	Min	Typ	Max
VDD	Core Digital Voltage		1.7	1.8	1.95
VDD_IO	I/O Digital Voltage		1.7 / 2.5	1.8 / 2.8	1.9 / 3.1
VAA	Analog Voltage		2.5	2.8	3.1
VAA_PIX	Pixel Supply Voltage		2.5	2.8	3.1
VDD_PLL	PLL Supply Voltage		2.5	2.8	3.1
VDD_SLVS	HiSPi Supply Voltage for SLVS Mode		0.3	0.4	0.6
VDD_SLVS	HiSPi Supply Voltage for HiVcm Mode		1.7	1.8	1.95
VIH	Input HIGH Voltage		$V_{DD\_IO} \times 0.7$	-	-
VIL	Input LOW Voltage		-	-	$V_{DD\_IO} \times 0.3$
IIN	Input Leakage Current	No pull-up resistor; $V_{IN} = V_{DD\_IO}$ or DGND	-	-	20
VOH	Output HIGH Voltage		$V_{DD\_IO} - 0.3$	-	-
VOL	Output LOW Voltage		-	-	0.4
IOH	Output HIGH Current	At specified VOH	-22	-	-
IOL	Output LOW Current	At specified VOL	-	-	22

Product parametric performance is indicated in the Electrical Characteristics for the listed test conditions, unless otherwise noted. Product performance may not be indicated by the Electrical Characteristics if operated under different conditions.

**CAUTION:** Stresses greater than those listed in Table 20 may cause permanent damage to the device. This is a stress rating only, and functional operation of the device at these or any other conditions above those indicated in the operational sections of this specification is not implied.

**Table 20. ABSOLUTE MAXIMUM RATINGS**

Symbol	Definition	Condition	Min	Max	Unit
VSUPPLY	Power Supply Voltage (All Supplies)	-0.3	4.5	V	VSUPPLY
ISUPPLY	Total Power Supply Current	-	200	mA	ISUPPLY
IGND	Total Ground Current	-	200	mA	IGND
VIN	DC Input Voltage	-0.3	$V_{DD\_IO} + 0.3$	V	VIN
VOUT	DC Output Voltage	-0.3	$V_{DD\_IO} + 0.3$	V	VOUT
TSTG (Note 17)	Storage Temperature	-40	+150	°C	TSTG (Note 17)

Stresses exceeding those listed in the Maximum Ratings table may damage the device. If any of these limits are exceeded, device functionality should not be assumed, damage may occur and reliability may be affected.

17. Exposure to absolute maximum rating conditions for extended periods may affect reliability.

18. To keep dark current and shot noise artifacts from impacting image quality, keep operating temperature at a minimum.

**Table 21. OPERATING CURRENT CONSUMPTION IN PARALLEL OUTPUT AND LINEAR MODE**

Definition	Condition	Symbol	Min	Typ	Max	Unit
Digital Operating Current	Streaming, 1280x960 45 fps	I <sub>DD1</sub>	–	63	90	mA
I/O Digital Operating Current	Streaming, 1280x960 45 fps	I <sub>DD_IO</sub>	–	35	40	mA
Analog Operating Current	Streaming, 1280x960 45 fps	I <sub>AA</sub>	–	30	45	mA
Pixel Supply Current	Streaming, 1280x960 45 fps	I <sub>AA_PIX</sub>	–	10	15	mA
PLL Supply Current	Streaming, 1280x960 45 fps	I <sub>DD_PLL</sub>	–	7	15	mA
Digital Operating Current	Streaming, 720p 60 fps	I <sub>DD1</sub>	–	63	90	mA
I/O Digital Operating Current	Streaming, 720p 60 fps	I <sub>DD_IO</sub>	–	35	40	mA
Analog Operating Current	Streaming, 720p 60 fps	I <sub>AA</sub>	–	30	45	mA
Pixel Supply Current	Streaming, 720p 60 fps	I <sub>AA_PIX</sub>	–	10	15	mA
PLL Supply Current	Streaming, 720p 60f ps	I <sub>DD_PLL</sub>	–	7	15	mA

19. Operating currents are measured at the following conditions:

- V<sub>AA</sub> = V<sub>AA\_PIX</sub> = V<sub>DD\_IO</sub> = V<sub>DD\_PLL</sub> = 2.8 V
- V<sub>DD</sub> = 1.8 V
- PLL Enabled and PIXCLK = 74.25 MHz
- T<sub>A</sub> = 25°C
- C<sub>LOAD</sub> = 10 pF Measured in dark

**Table 22. OPERATING CURRENT CONSUMPTION IN PARALLEL OUTPUT AND HDR MODE**

Definition	Condition	Symbol	Min	Typ	Max	Unit
Digital Operating Current	Streaming, 1280x960 45 fps	I <sub>DD1</sub>	–	63	90	mA
Digital Operating Current	Streaming, 1280x960 45 fps	I <sub>DD</sub>	–	95	115	mA
I/O Digital Operating Current	Streaming, 1280x960 45 fps	I <sub>DD_IO</sub>	–	35	40	mA
Analog Operating Current	Streaming, 1280x960 45 fps	I <sub>AA</sub>	–	65	75	mA
Pixel Supply Current	Streaming, 1280x960 45 fps	I <sub>AA_PIX</sub>	–	15	20	mA
PLL Supply Current	Streaming, 1280x960 45 fps	I <sub>DD_PLL</sub>	–	7	15	mA
Digital Operating Current	Streaming, 720p 60 fps	I <sub>DD</sub>	–	95	115	mA
I/O Digital Operating Current	Streaming, 720p 60 fps	I <sub>DD_IO</sub>	–	35	40	mA
Analog Operating Current	Streaming, 720p 60 fps	I <sub>AA</sub>	–	61	75	mA
Pixel Supply Current	Streaming, 720p 60 fps	I <sub>AA_PIX</sub>	–	15	20	mA
PLL Supply Current	Streaming, 720p 60 fps	I <sub>DD_PLL</sub>	–	7	15	mA

20. Operating currents are measured at the following conditions:

- V<sub>AA</sub> = V<sub>AA\_PIX</sub> = V<sub>DD\_IO</sub> = V<sub>DD\_PLL</sub> = 2.8 V
- V<sub>DD</sub> = 1.8 V
- PLL Enabled and PIXCLK = 74.25 MHz
- T<sub>A</sub> = 25°C
- C<sub>LOAD</sub> = 10 pF Measured in dark

**Table 23. STANDBY CURRENT CONSUMPTION**

Definition	Condition	Symbol	Min	Typ	Max	Unit
Hard Standby (Clock Off)	Analog, 2.8 V	–	–	30	100	μA
	Digital, 1.8 V	–	–	85	2500	μA
Hard Standby (Clock On)	Analog, 2.8 V	–	–	30	100	μA
	Digital, 1.8 V	–	–	1.55	4	mA
Soft Standby (Clock Off)	Analog, 2.8 V	–	–	85	100	μA
	Digital, 1.8 V	–	–	85	2500	μA
Soft Standby (Clock On)	Analog, 2.8 V	–	–	30	100	μA
	Digital, 1.8 V	–	–	1.55	4	mA

21. Analog – V<sub>AA</sub> + V<sub>AA\_PIX</sub> + V<sub>DD\_PLL</sub>

22. Digital – V<sub>DD</sub> + V<sub>DD\_IO</sub>

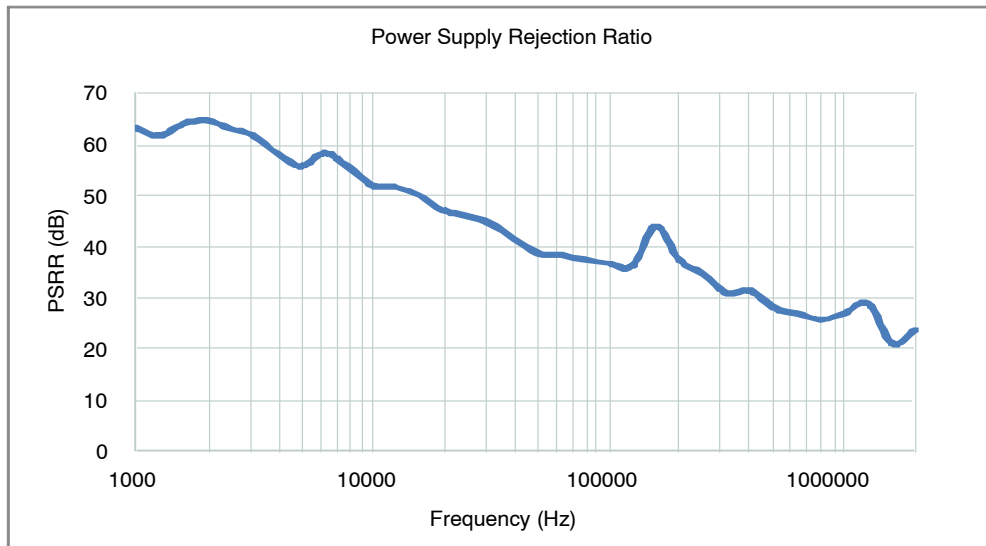

Figure 28. Power Supply Rejection Ratio

**POWER-ON RESET AND STANDBY TIMING**

**Power-Up Sequence**

The recommended power-up sequence for the MT9M034 is shown in Figure 29. The available power supplies (VDD\_IO, VDD, VDD\_PLL, VAA, VAA\_PIX) must have the separation specified below.

1. Turn on VDD\_PLL power supply
2. After 0–10 μs, turn on VAA and VAA\_PIX power supply

3. After 0–10 μs, turn on VDD\_IO power supply
4. After the last power supply is stable, enable EXTCLK
5. Assert RESET\_BAR for at least 1 ms
6. Wait 850000 EXTCLKs (for internal initialization into software standby)
7. Configure PLL, output, and image settings to desired values
8. Wait 1ms for the PLL to lock
9. Set streaming mode (R0x301A[2] = 1)

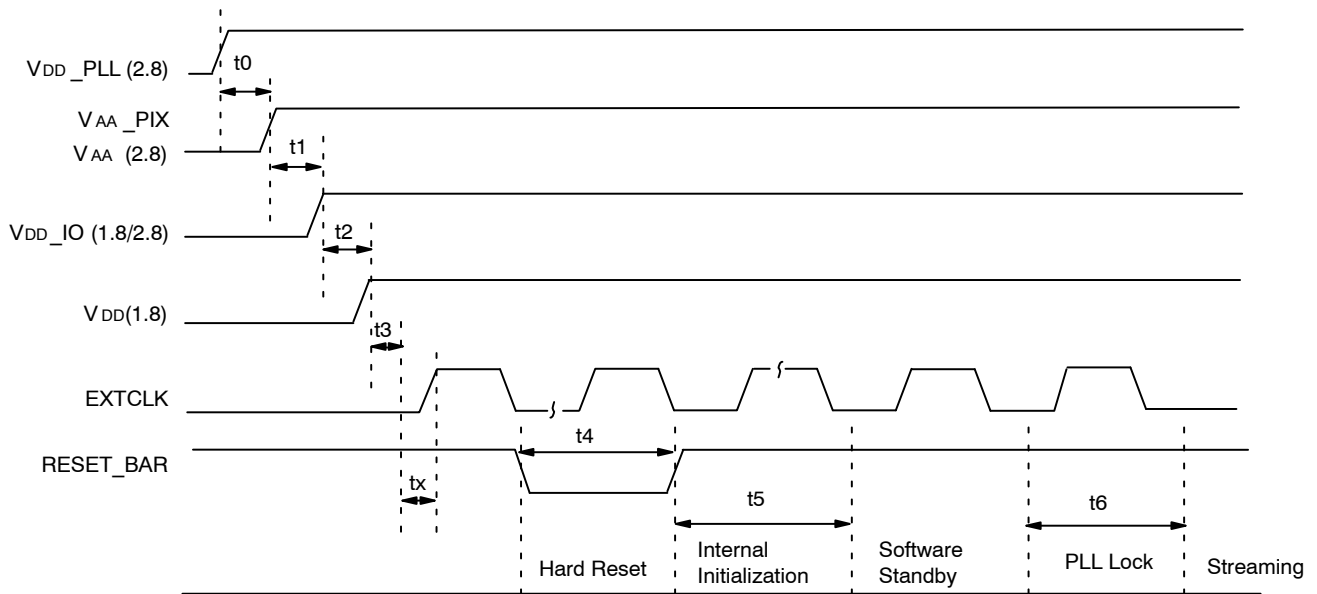

Figure 29. Power Up

**Table 24. POWER-UP SEQUENCE**

Definition	Symbol	Min	Typ	Max	Unit
VDD_PLL to VAA/VAA_PIX (Note 25)	t0	0	10	-	μs
VAA/VAA_PIX to VDD_IO	t1	0	10	-	μs
VDD_IO to VDD	t2	0	10	-	μs
Xtal Settle Time	tx	-	30 (Note 23)	-	ms
Hard Reset	t4	1 (Note 24)	-	-	ms
Internal Initialization	t5	850000	-	-	EXTCLKS
PLL Lock Time	t6	1	-	-	ms

23. Xtal settling time is component-dependent, usually taking about 10–100 ms.

24. Hard reset time is the minimum time required after power rails are settled. In a circuit where Hard reset is held down by RC circuit, then the RC time must include the all power rail settle time and Xtal settle time.

25. It is critical that VDD\_PLL is not powered up after the other power supplies. It must be powered before or at least at the same time as the others. If the case happens that VDD\_PLL is powered after other supplies then sensor may have functionality issues and will experience high current draw on this supply.

**Power-Down Sequence**

The recommended power-down sequence for the MT9M034 is shown in Figure 30. The available power supplies (VDD\_IO, VDD, VDD\_PLL, VAA, VAA\_PIX) must have the separation specified below. Power may be removed from all supplies simultaneously, and a sudden loss of power on all rails does not cause damage or affect the lifetime of the device.

1. Disable streaming if output is active by setting standby R0x301A[2] = 0

2. The soft standby state is reached after the current row or frame, depending on configuration, has ended
3. Turn off VDD
4. Turn off VDD\_IO
5. Turn off VAA/VAA\_PIX
6. Turn off VDD\_PLL

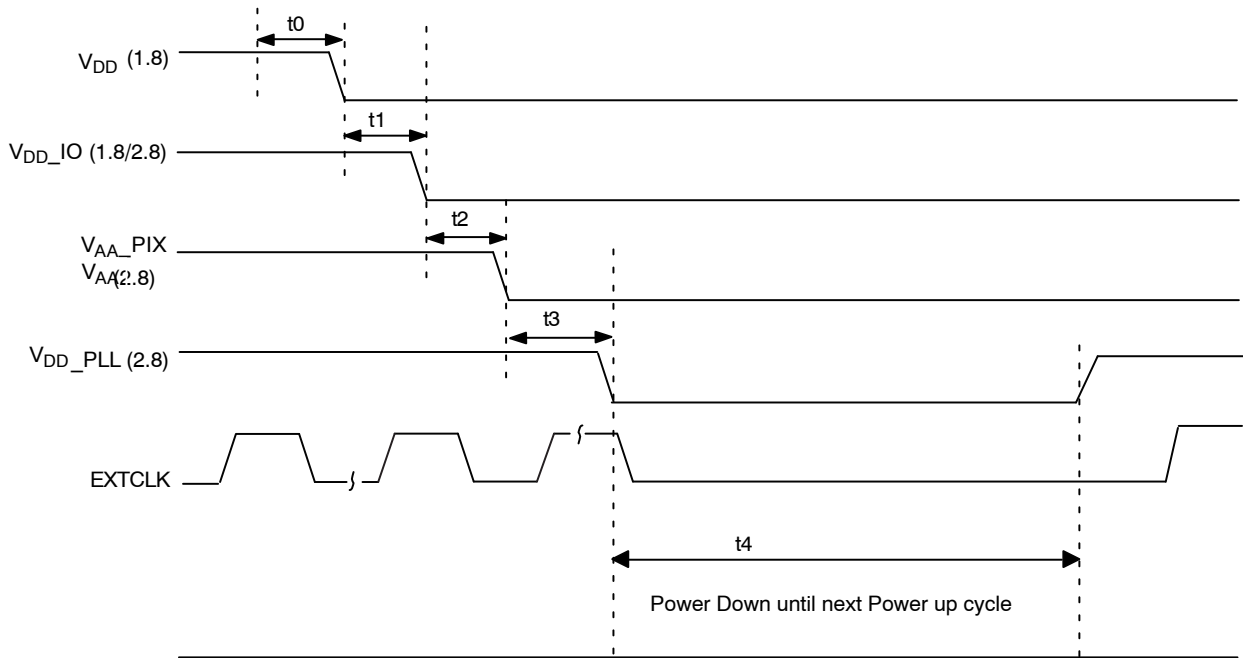

**Figure 30. Power Down**

**Table 25. POWER-DOWN SEQUENCE**

Definition	Symbol	Min	Typ	Max	Unit
VDD to VDD_IO	t1	0	-	-	μs
VDD_IO to VAA/VAA_PIX	t2	0	-	-	μs
VAA/VAA_PIX to VDD_PLL	t3	0	-	-	μs
PwrDn until Next PwrUp Time	t4	100	-	-	ms

26. t4 is required between power down and next power up time; all decoupling caps from regulators must be completely discharged.

# MECHANICAL CASE OUTLINE

## PACKAGE DIMENSIONS

### ILCC48 10x10 CASE 847AD ISSUE O

DATE 30 DEC 2014

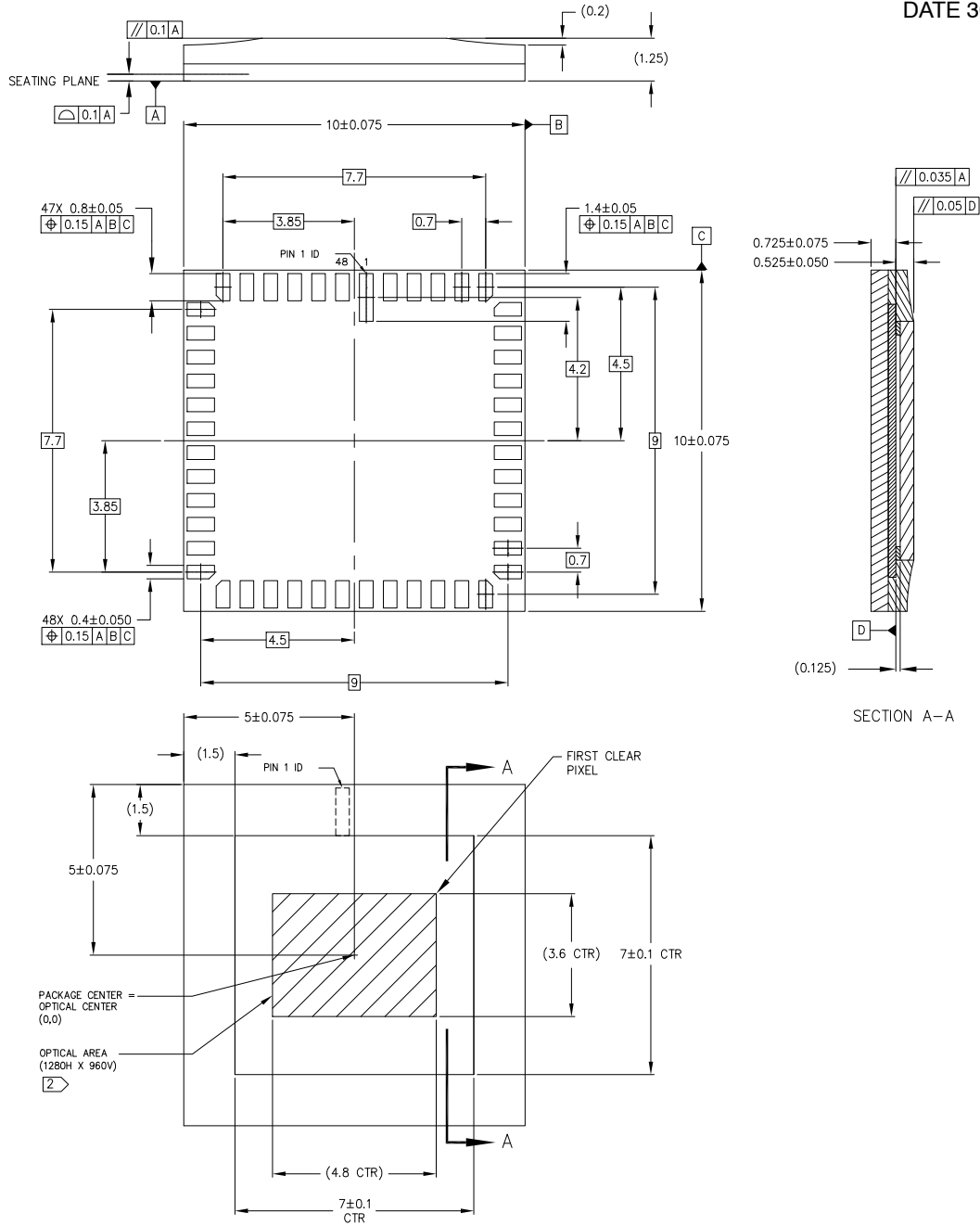

NOTES	
1	DIMENSIONS IN MM. DIMENSIONS IN ( ) ARE FOR REFERENCE ONLY.
2	MAXIMUM ROTATION OF OPTICAL AREA RELATIVE TO PACKAGE EDGES: 1° MAXIMUM TILT OF OPTICAL AREA RELATIVE TO SUBSTRATE PLANE [A]: 35 MICRONS MAXIMUM TILT OF COVER GLASS RELATIVE TO OPTICAL AREA PLANE [D]: 50 MICRONS.

<b>DOCUMENT NUMBER:</b>	<b>98AON93695F</b>	Electronic versions are uncontrolled except when accessed directly from the Document Repository. Printed versions are uncontrolled except when stamped "CONTROLLED COPY" in red.
<b>DESCRIPTION:</b>	<b>ILCC48 10X10</b>	<b>PAGE 1 OF 1</b>

ON Semiconductor and **ON** are trademarks of Semiconductor Components Industries, LLC dba ON Semiconductor or its subsidiaries in the United States and/or other countries. ON Semiconductor reserves the right to make changes without further notice to any products herein. ON Semiconductor makes no warranty, representation or guarantee regarding the suitability of its products for any particular purpose, nor does ON Semiconductor assume any liability arising out of the application or use of any product or circuit, and specifically disclaims any and all liability, including without limitation special, consequential or incidental damages. ON Semiconductor does not convey any license under its patent rights nor the rights of others.

**onsemi**, **Onsemi**, and other names, marks, and brands are registered and/or common law trademarks of Semiconductor Components Industries, LLC dba "**onsemi**" or its affiliates and/or subsidiaries in the United States and/or other countries. **onsemi** owns the rights to a number of patents, trademarks, copyrights, trade secrets, and other intellectual property. A listing of **onsemi**'s product/patent coverage may be accessed at [www.onsemi.com/site/pdf/Patent-Marking.pdf](http://www.onsemi.com/site/pdf/Patent-Marking.pdf). **onsemi** reserves the right to make changes at any time to any products or information herein, without notice. The information herein is provided "as-is" and **onsemi** makes no warranty, representation or guarantee regarding the accuracy of the information, product features, availability, functionality, or suitability of its products for any particular purpose, nor does **onsemi** assume any liability arising out of the application or use of any product or circuit, and specifically disclaims any and all liability, including without limitation special, consequential or incidental damages. Buyer is responsible for its products and applications using **onsemi** products, including compliance with all laws, regulations and safety requirements or standards, regardless of any support or applications information provided by **onsemi**. "Typical" parameters which may be provided in **onsemi** data sheets and/or specifications can and do vary in different applications and actual performance may vary over time. All operating parameters, including "Typicals" must be validated for each customer application by customer's technical experts. **onsemi** does not convey any license under any of its intellectual property rights nor the rights of others. **onsemi** products are not designed, intended, or authorized for use as a critical component in life support systems or any FDA Class 3 medical devices or medical devices with a same or similar classification in a foreign jurisdiction or any devices intended for implantation in the human body. Should Buyer purchase or use **onsemi** products for any such unintended or unauthorized application, Buyer shall indemnify and hold **onsemi** and its officers, employees, subsidiaries, affiliates, and distributors harmless against all claims, costs, damages, and expenses, and reasonable attorney fees arising out of, directly or indirectly, any claim of personal injury or death associated with such unintended or unauthorized use, even if such claim alleges that **onsemi** was negligent regarding the design or manufacture of the part. **onsemi** is an Equal Opportunity/Affirmative Action Employer. This literature is subject to all applicable copyright laws and is not for resale in any manner.

## ADDITIONAL INFORMATION

### TECHNICAL PUBLICATIONS:

Technical Library: [www.onsemi.com/design/resources/technical-documentation](http://www.onsemi.com/design/resources/technical-documentation)  
onsemi Website: [www.onsemi.com](http://www.onsemi.com)

### ONLINE SUPPORT: [www.onsemi.com/support](http://www.onsemi.com/support)

For additional information, please contact your local Sales Representative at [www.onsemi.com/support/sales](http://www.onsemi.com/support/sales)