

# MJF47G

## High Voltage Power Transistor

### Isolated Package Applications

Designed for line operated audio output amplifiers, switching power supply drivers and other switching applications, where the mounting surface of the device is required to be electrically isolated from the heatsink or chassis.

#### Features

- Electrically Similar to the Popular TIP47
- 250 V<sub>CEO(sus)</sub>
- 1 A Rated Collector Current
- No Isolating Washers Required
- Reduced System Cost
- UL Recognized, File #E69369, to 3500 V<sub>RMS</sub> Isolation
- This is a Pb-Free Device\*

#### MAXIMUM RATINGS

Rating	Symbol	Value	Unit
Collector-Emitter Voltage	V <sub>CEO</sub>	250	Vdc
Collector-Base Voltage	V <sub>CB</sub>	350	Vdc
Emitter-Base Voltage	V <sub>EB</sub>	5	Vdc
RMS Isolation Voltage (Note 1) Test No. 1 Per Figure 10 Test No. 2 Per Figure 11 Test No. 3 Per Figure 12 (for 1 sec, R.H. < 30%, T <sub>A</sub> = 25°C)	V <sub>ISOL</sub>	4500 3500 1500	V
Collector Current – Continuous – Peak	I <sub>C</sub>	1 2	Adc
Base Current – Continuous	I <sub>B</sub>	0.6	Adc
Total Power Dissipation (Note 2) @ T <sub>C</sub> = 25°C Derate above 25°C	P <sub>D</sub>	28.4 0.227	W W/°C
Total Power Dissipation @ T <sub>A</sub> = 25°C Derate above 25°C	P <sub>D</sub>	2.0 0.016	W W/°C
Operating and Storage Temperature Range	T <sub>J</sub> , T <sub>stg</sub>	-65 to +150	°C

#### THERMAL CHARACTERISTICS

Characteristic	Symbol	Max	Unit
Thermal Resistance, Junction-to-Ambient	R <sub>θJA</sub>	62.5	°C/W
Thermal Resistance, Junction-to-Case (Note 2)	R <sub>θJC</sub>	4.4	°C/W
Lead Temperature for Soldering Purposes	T <sub>L</sub>	260	°C

Stresses exceeding Maximum Ratings may damage the device. Maximum Ratings are stress ratings only. Functional operation above the Recommended Operating Conditions is not implied. Extended exposure to stresses above the Recommended Operating Conditions may affect device reliability.

1. Proper strike and creepage distance must be provided.
2. Measurement made with thermocouple contacting the bottom insulated surface (in a location beneath the die), the devices mounted on a heatsink with thermal grease and a mounting torque of ≥ 6 in. lbs.

\*For additional information on our Pb-Free strategy and soldering details, please download the ON Semiconductor Soldering and Mounting Techniques Reference Manual, SOLDERRM/D.



ON Semiconductor®

<http://onsemi.com>

**NPN SILICON  
POWER TRANSISTOR  
1 AMPERE  
250 VOLTS, 28 WATTS**

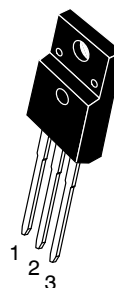

TO-220 FULLPACK  
CASE 221D  
STYLE 2

#### MARKING DIAGRAM

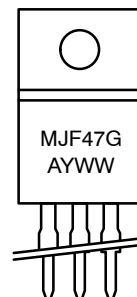

G = Pb-Free Package  
A = Assembly Location  
Y = Year  
WW = Work Week

#### ORDERING INFORMATION

Device	Package	Shipping
MJF47G	TO-220 FULLPACK (Pb-Free)	50 Units/Rail

\*For additional information on our Pb-Free strategy and soldering details, please download the ON Semiconductor Soldering and Mounting Techniques Reference Manual, SOLDERRM/D.

# MJF47G

## ELECTRICAL CHARACTERISTICS ( $T_C = 25^\circ\text{C}$ unless otherwise noted)

Characteristic	Symbol	Min	Max	Unit
<b>OFF CHARACTERISTICS</b>				
Collector–Emitter Sustaining Voltage (Note 3) ( $I_C = 30\text{ mAdc}$ , $I_B = 0$ )	$V_{CE(sus)}$	250	–	Vdc
Collector Cutoff Current ( $V_{CE} = 150\text{ Vdc}$ , $I_B = 0$ )	$I_{CEO}$	–	0.2	mAdc
Collector Cutoff Current ( $V_{CE} = 350\text{ Vdc}$ , $V_{BE} = 0$ )	$I_{CES}$	–	0.1	mAdc
Emitter Cutoff Current ( $V_{BE} = 5\text{ Vdc}$ , $I_C = 0$ )	$I_{EBO}$	–	1	mAdc
<b>ON CHARACTERISTICS (Note 3)</b>				
DC Current Gain ( $I_C = 0.3\text{ Adc}$ , $V_{CE} = 10\text{ Vdc}$ ) ( $I_C = 1\text{ Adc}$ , $V_{CE} = 10\text{ Vdc}$ )	$h_{FE}$	30 10	150 –	–
Collector–Emitter Saturation Voltage ( $I_C = 1\text{ Adc}$ , $I_B = 0.2\text{ Adc}$ )	$V_{CE(sat)}$	–	1	Vdc
Base–Emitter On Voltage ( $I_C = 1\text{ Adc}$ , $V_{CE} = 10\text{ Vdc}$ )	$V_{BE(on)}$	–	1.5	Vdc
<b>DYNAMIC CHARACTERISTICS</b>				
Current Gain – Bandwidth Product ( $I_C = 0.2\text{ Adc}$ , $V_{CE} = 10\text{ Vdc}$ , $f = 2\text{ MHz}$ )	$f_T$	10	–	MHz

3. Pulse Test: Pulse Width  $\leq 300\ \mu\text{s}$ , Duty Cycle  $\leq 2\%$ .

## TYPICAL CHARACTERISTICS

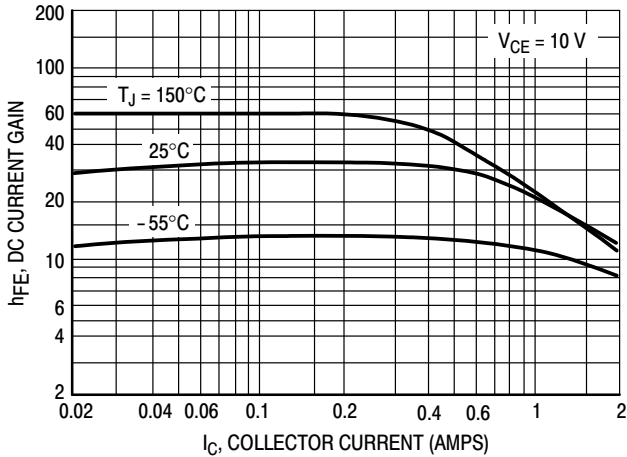

Figure 1. DC Current Gain

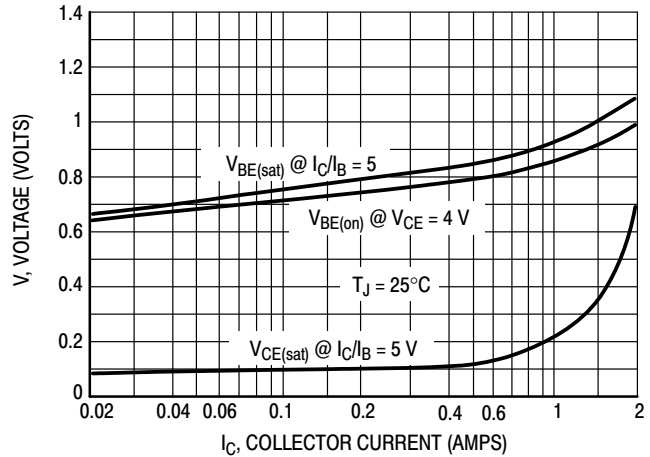

Figure 2. "On" Voltages

# MJF47G

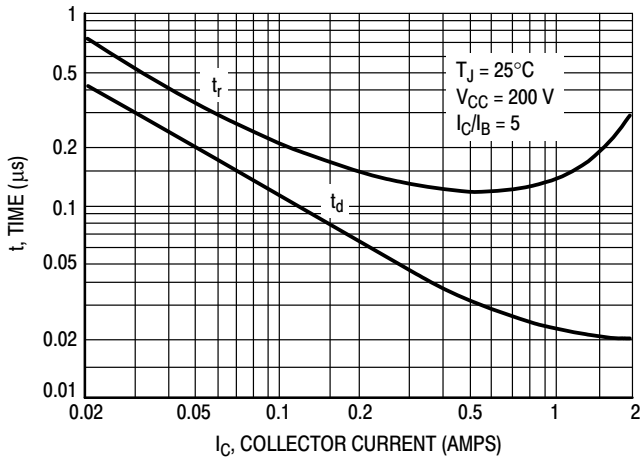

Figure 3. Turn-On Time

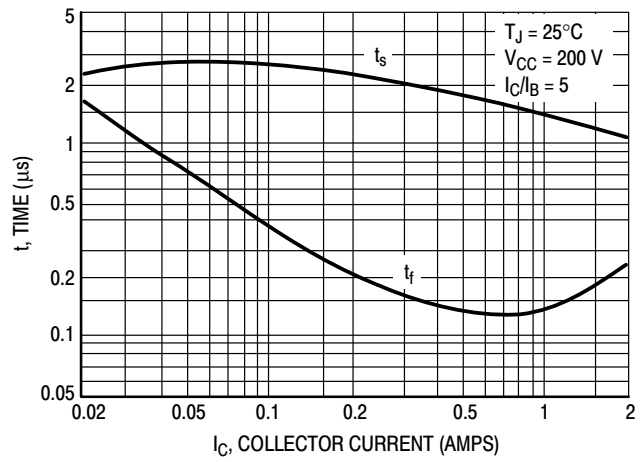

Figure 4. Turn-Off Time

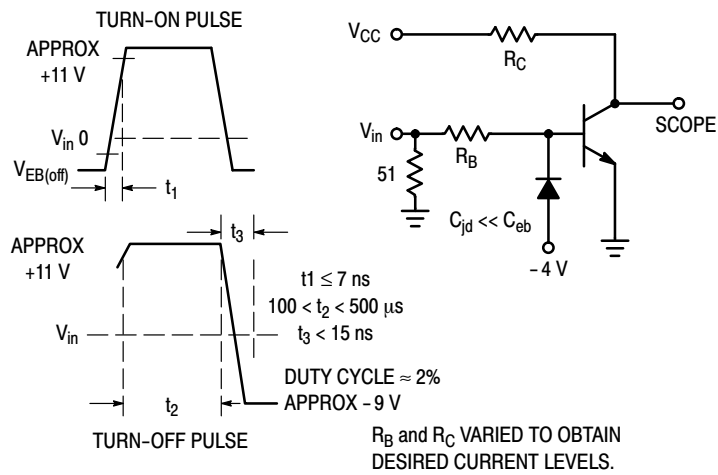

Figure 5. Switching Time Equivalent Circuit

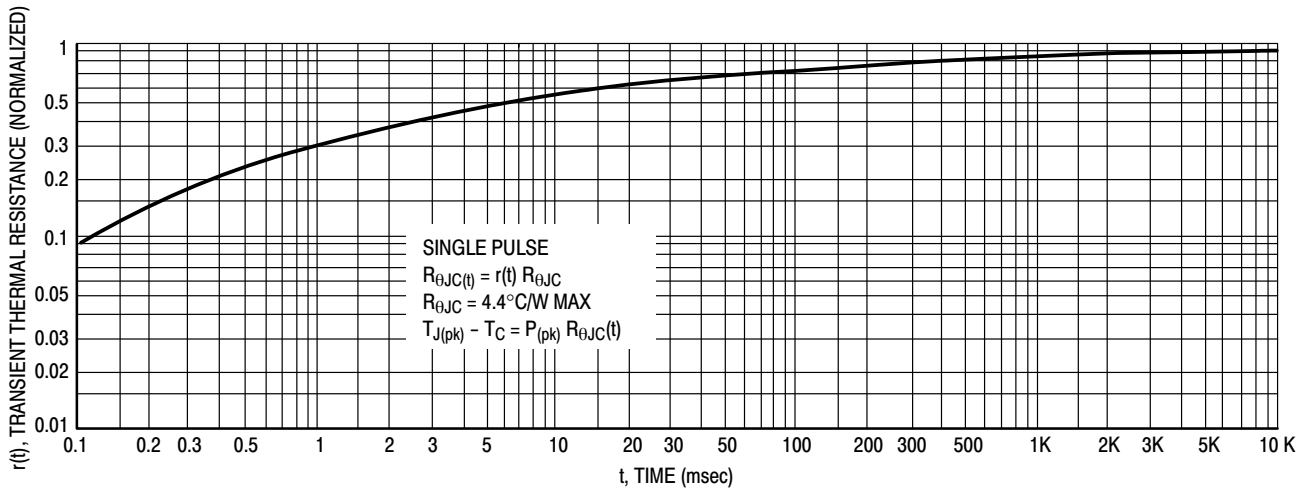
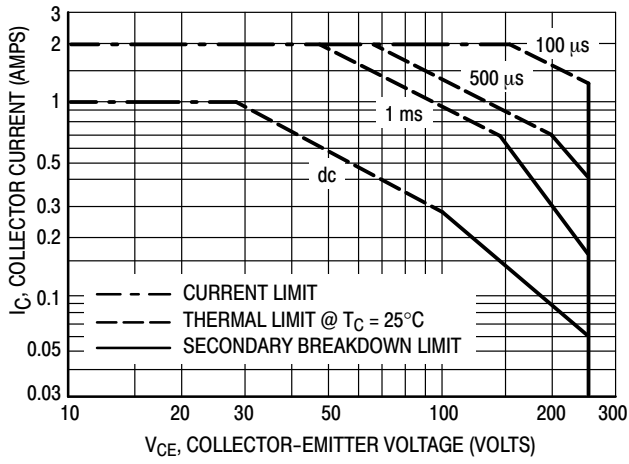

Figure 6. Thermal Response

# MJF47G



**Figure 7. Maximum Forward Bias Safe Operating Area**

There are two limitations on the power handling ability of a transistor: average junction temperature and second breakdown. Safe operating area curves indicate  $I_C - V_{CE}$  limits of the transistor that must be observed for reliable operation; i.e., the transistor must not be subjected to greater dissipation than the curves indicate.

The data of Figure 7 is based on  $T_{J(pk)} = 150^\circ\text{C}$ ;  $T_C$  is variable depending on conditions. Second breakdown pulse limits are valid for duty cycles to 10% provided  $T_{J(pk)} \leq 150^\circ\text{C}$ .  $T_{J(pk)}$  may be calculated from the data in Figure 6. At high case temperatures, thermal limitations will reduce the power that can be handled to values less than the limitations imposed by second breakdown.

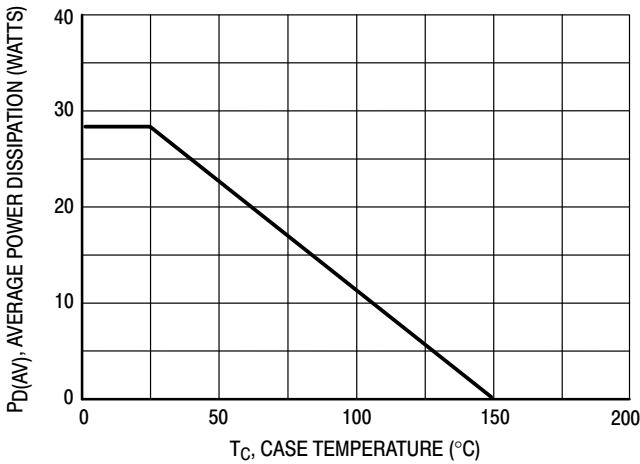

**Figure 8. Power Derating**

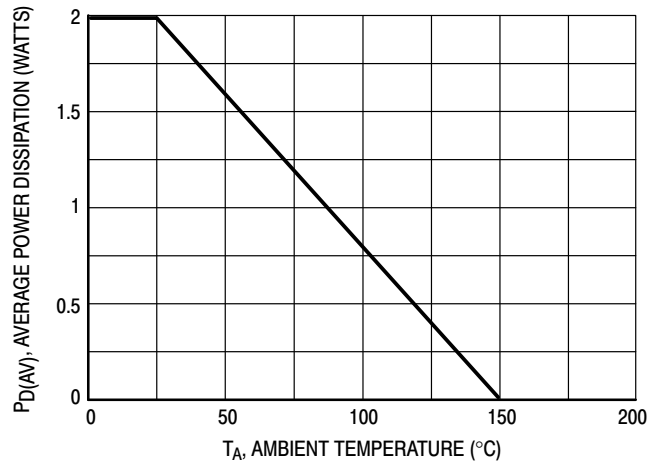

**Figure 9. Power Derating**

# MJF47G

## TEST CONDITIONS FOR ISOLATION TESTS\*

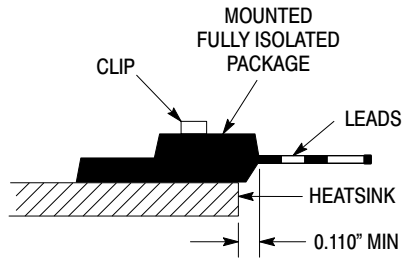

Figure 10. Clip Mounting Position for Isolation Test Number 1

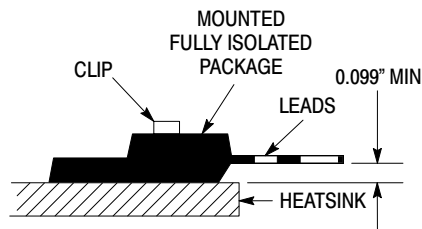

Figure 11. Clip Mounting Position for Isolation Test Number 2

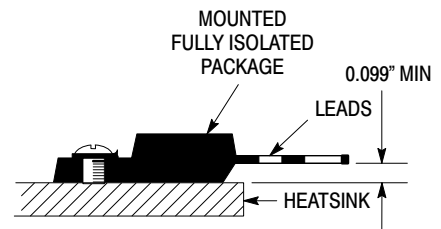

Figure 12. Screw Mounting Position for Isolation Test Number 3

\*Measurement made between leads and heatsink with all leads shorted together

## MOUNTING INFORMATION

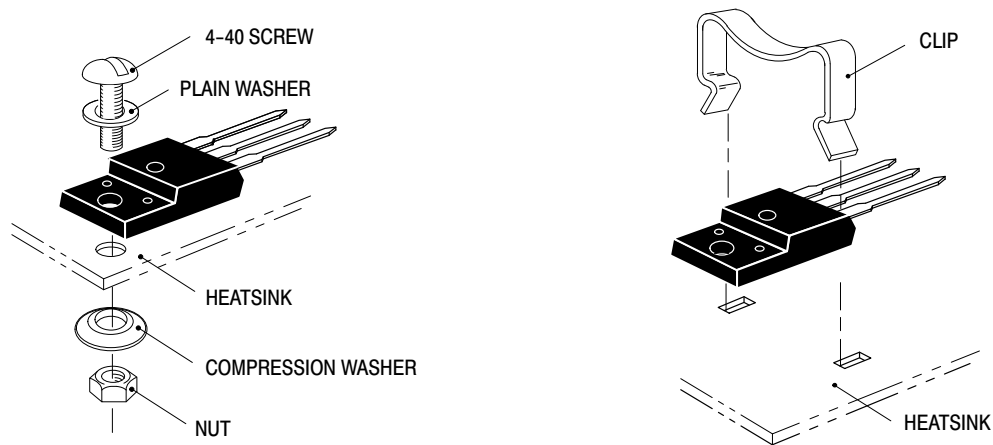

Figure 13. Typical Mounting Techniques\*

Laboratory tests on a limited number of samples indicate, when using the screw and compression washer mounting technique, a screw torque of 6 to 8 in · lbs is sufficient to provide maximum power dissipation capability. The compression washer helps to maintain a constant pressure on the package over time and during large temperature excursions.

Destructive laboratory tests show that using a hex head 4-40 screw, without washers, and applying a torque in excess of 20 in · lbs will cause the plastic to crack around the mounting hole, resulting in a loss of isolation capability.

Additional tests on slotted 4-40 screws indicate that the screw slot fails between 15 to 20 in · lbs without adversely affecting the package. However, in order to positively ensure the package integrity of the fully isolated device, ON Semiconductor does not recommend exceeding 10 in · lbs of mounting torque under any mounting conditions.

\*\* For more information about mounting power semiconductors see Application Note AN1040.

# MECHANICAL CASE OUTLINE PACKAGE DIMENSIONS

ON Semiconductor®

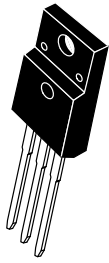

SCALE 1:1

## TO-220 FULLPAK CASE 221D-03 ISSUE K

DATE 27 FEB 2009

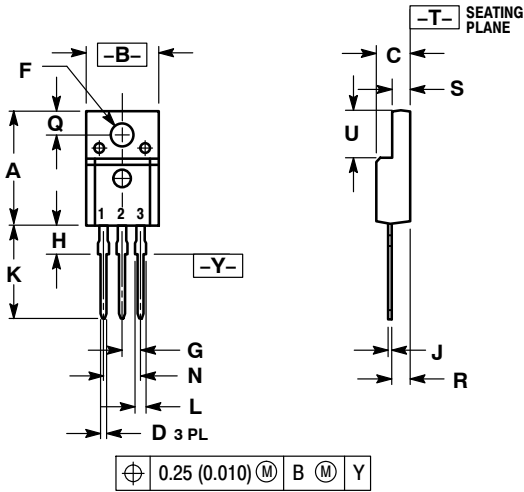

- NOTES:
- DIMENSIONING AND TOLERANCING PER ANSI Y14.5M, 1982.
  - CONTROLLING DIMENSION: INCH
  - 221D-01 THRU 221D-02 OBSOLETE, NEW STANDARD 221D-03.

DIM	INCHES		MILLIMETERS	
	MIN	MAX	MIN	MAX
A	0.617	0.635	15.67	16.12
B	0.392	0.419	9.96	10.63
C	0.177	0.193	4.50	4.90
D	0.024	0.039	0.60	1.00
F	0.116	0.129	2.95	3.28
G	0.100 BSC		2.54 BSC	
H	0.118	0.135	3.00	3.43
J	0.018	0.025	0.45	0.63
K	0.503	0.541	12.78	13.73
L	0.048	0.058	1.23	1.47
N	0.200 BSC		5.08 BSC	
Q	0.122	0.138	3.10	3.50
R	0.099	0.117	2.51	2.96
S	0.092	0.113	2.34	2.87
U	0.239	0.271	6.06	6.88

### MARKING DIAGRAMS

- |  |   |  |
|--|---|--|
| STYLE 1:<br>PIN 1. GATE<br>2. DRAIN<br>3. SOURCE     | STYLE 2:<br>PIN 1. BASE<br>2. COLLECTOR<br>3. EMITTER | STYLE 3:<br>PIN 1. ANODE<br>2. CATHODE<br>3. ANODE |
| STYLE 4:<br>PIN 1. CATHODE<br>2. ANODE<br>3. CATHODE | STYLE 5:<br>PIN 1. CATHODE<br>2. ANODE<br>3. GATE     | STYLE 6:<br>PIN 1. MT 1<br>2. MT 2<br>3. GATE      |



**Bipolar**

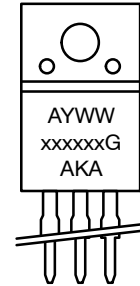

**Rectifier**

- |                               |                           |
|-------------------------------|---------------------------|
| xxxxxx = Specific Device Code | A = Assembly Location     |
| G = Pb-Free Package           | Y = Year                  |
| A = Assembly Location         | WW = Work Week            |
| Y = Year                      | xxxxxx = Device Code      |
| WW = Work Week                | G = Pb-Free Package       |
|                               | AKA = Polarity Designator |

<b>DOCUMENT NUMBER:</b>	<b>98ASB42514B</b>	Electronic versions are uncontrolled except when accessed directly from the Document Repository. Printed versions are uncontrolled except when stamped "CONTROLLED COPY" in red.
<b>DESCRIPTION:</b>	<b>TO-220 FULLPAK</b>	<b>PAGE 1 OF 1</b>

ON Semiconductor and are trademarks of Semiconductor Components Industries, LLC dba ON Semiconductor or its subsidiaries in the United States and/or other countries. ON Semiconductor reserves the right to make changes without further notice to any products herein. ON Semiconductor makes no warranty, representation or guarantee regarding the suitability of its products for any particular purpose, nor does ON Semiconductor assume any liability arising out of the application or use of any product or circuit, and specifically disclaims any and all liability, including without limitation special, consequential or incidental damages. ON Semiconductor does not convey any license under its patent rights nor the rights of others.

**onsemi**, **Onsemi**, and other names, marks, and brands are registered and/or common law trademarks of Semiconductor Components Industries, LLC dba "**onsemi**" or its affiliates and/or subsidiaries in the United States and/or other countries. **onsemi** owns the rights to a number of patents, trademarks, copyrights, trade secrets, and other intellectual property. A listing of **onsemi**'s product/patent coverage may be accessed at [www.onsemi.com/site/pdf/Patent-Marking.pdf](http://www.onsemi.com/site/pdf/Patent-Marking.pdf). **onsemi** reserves the right to make changes at any time to any products or information herein, without notice. The information herein is provided "as-is" and **onsemi** makes no warranty, representation or guarantee regarding the accuracy of the information, product features, availability, functionality, or suitability of its products for any particular purpose, nor does **onsemi** assume any liability arising out of the application or use of any product or circuit, and specifically disclaims any and all liability, including without limitation special, consequential or incidental damages. Buyer is responsible for its products and applications using **onsemi** products, including compliance with all laws, regulations and safety requirements or standards, regardless of any support or applications information provided by **onsemi**. "Typical" parameters which may be provided in **onsemi** data sheets and/or specifications can and do vary in different applications and actual performance may vary over time. All operating parameters, including "Typicals" must be validated for each customer application by customer's technical experts. **onsemi** does not convey any license under any of its intellectual property rights nor the rights of others. **onsemi** products are not designed, intended, or authorized for use as a critical component in life support systems or any FDA Class 3 medical devices or medical devices with a same or similar classification in a foreign jurisdiction or any devices intended for implantation in the human body. Should Buyer purchase or use **onsemi** products for any such unintended or unauthorized application, Buyer shall indemnify and hold **onsemi** and its officers, employees, subsidiaries, affiliates, and distributors harmless against all claims, costs, damages, and expenses, and reasonable attorney fees arising out of, directly or indirectly, any claim of personal injury or death associated with such unintended or unauthorized use, even if such claim alleges that **onsemi** was negligent regarding the design or manufacture of the part. **onsemi** is an Equal Opportunity/Affirmative Action Employer. This literature is subject to all applicable copyright laws and is not for resale in any manner.

## ADDITIONAL INFORMATION

### TECHNICAL PUBLICATIONS:

Technical Library: [www.onsemi.com/design/resources/technical-documentation](http://www.onsemi.com/design/resources/technical-documentation)  
onsemi Website: [www.onsemi.com](http://www.onsemi.com)

### ONLINE SUPPORT: [www.onsemi.com/support](http://www.onsemi.com/support)

For additional information, please contact your local Sales Representative at [www.onsemi.com/support/sales](http://www.onsemi.com/support/sales)