

M1MA151KT1, M1MA152KT1

Preferred Device

Single Silicon Switching Diodes

These Silicon Epitaxial Planar Diodes are designed for use in ultra high speed switching applications. These devices are housed in the SC-59 package which is designed for low power surface mount applications.

Features

- Fast t_{rr} , < 3.0 ns
- Low C_D , < 2.0 pF
- Available in 8 mm Tape and Reel
 - Use M1MA151/2KT1 to order the 7 inch/3000 unit reel.
 - Use M1MA151/2KT3 to order the 13 inch/10,000 unit reel.
- Pb-Free Packages are Available

MAXIMUM RATINGS ($T_A = 25^\circ\text{C}$)

| Rating | | Symbol | Value | Unit |
|----------------------------|------------|-----------------------|-------|------|
| Reverse Voltage | M1MA151KT1 | V_R | 40 | Vdc |
| | M1MA152KT1 | | 80 | |
| Peak Reverse Voltage | M1MA151KT1 | V_{RM} | 40 | Vdc |
| | M1MA152KT1 | | 80 | |
| Forward Current | | I_F | 100 | mAdc |
| Peak Forward Current | | I_{FM} | 225 | mAdc |
| Peak Forward Surge Current | | I_{FSM} (Note 1) | 500 | mAdc |

THERMAL CHARACTERISTICS

| Rating | Symbol | Max | Unit |
|----------------------|-----------|-------------|------------------|
| Power Dissipation | P_D | 200 | mW |
| Junction Temperature | T_J | 150 | $^\circ\text{C}$ |
| Storage Temperature | T_{stg} | -55 to +150 | $^\circ\text{C}$ |

Maximum ratings are those values beyond which device damage can occur. Maximum ratings applied to the device are individual stress limit values (not normal operating conditions) and are not valid simultaneously. If these limits are exceeded, device functional operation is not implied, damage may occur and reliability may be affected.

1. $t = 1 \text{ SEC}$



ON Semiconductor®

<http://onsemi.com>

SC-59 PACKAGE SINGLE SILICON SWITCHING DIODES 40/80 V-100 mA SURFACE MOUNT

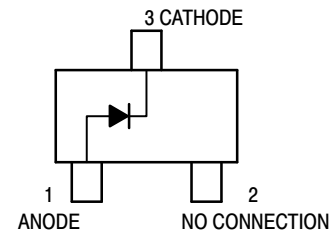

SC-59
CASE 318D

MARKING DIAGRAM

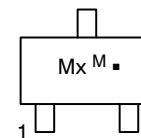

- Mx = Device Code
 - x = H for 151
I for 152
 - M = Date Code*
 - = Pb-Free Package
- (Note: Microdot may be in either location)

*Date Code orientation may vary depending upon manufacturing location.

ORDERING INFORMATION

See detailed ordering and shipping information in the package dimensions section on page 2 of this data sheet.

Preferred devices are recommended choices for future use and best overall value.

M1MA151KT1, M1MA152KT1

ELECTRICAL CHARACTERISTICS (T_A = 25°C)

| Characteristic | Symbol | Condition | Min | Max | Unit |
|----------------------------------|--------------------------|--|-----|-----|------------------|
| Reverse Voltage Leakage Current | M1MA151KT1 | V _R = 35 V | - | 0.1 | μA _{dc} |
| | M1MA152KT1 | | | | |
| Forward Voltage | V _F | I _F = 100 mA | - | 1.2 | V _{dc} |
| Reverse Breakdown Voltage | M1MA151KT1 | I _R = 100 μA | 40 | - | V _{dc} |
| | M1MA152KT1 | | | | |
| Diode Capacitance | C _D | V _R = 0, f = 1.0 MHz | - | 2.0 | pF |
| Reverse Recovery Time (Figure 1) | t _{rr} (Note 2) | I _F = 10 mA, V _R = 6.0 V, R _L = 100 Ω, I _{rr} = 0.1 I _R | - | 3.0 | ns |

2. t_{rr} Test Circuit

RECOVERY TIME EQUIVALENT TEST CIRCUIT

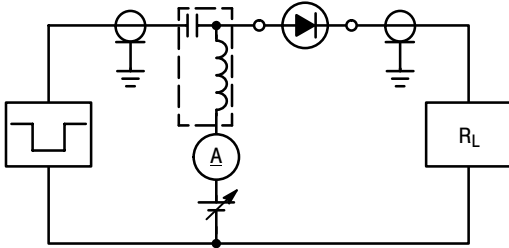

INPUT PULSE

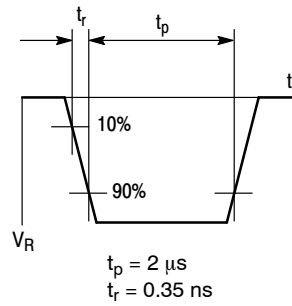

OUTPUT PULSE

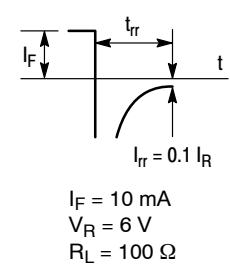

Figure 1. Reverse Recovery Time Equivalent Test Circuit

ORDERING INFORMATION

| Device | Package | Shipping† |
|-------------|--------------------|--------------------------|
| M1MA151KT1 | SC-59 | 3000 Units / Tape & Reel |
| M1MA151KT1G | SC-59 (Pb-Free) | 3000 Units / Tape & Reel |
| M1MA152KT1 | SC-59 | 3000 Units / Tape & Reel |
| M1MA152KT1G | SC-59 (Pb-Free) | 3000 Units / Tape & Reel |

†For information on tape and reel specifications, including part orientation and tape sizes, please refer to our Tape and Reel Packaging Specifications Brochure, BRD8011/D.

onsemi, **Onsemi**, and other names, marks, and brands are registered and/or common law trademarks of Semiconductor Components Industries, LLC dba "**onsemi**" or its affiliates and/or subsidiaries in the United States and/or other countries. **onsemi** owns the rights to a number of patents, trademarks, copyrights, trade secrets, and other intellectual property. A listing of **onsemi**'s product/patent coverage may be accessed at www.onsemi.com/site/pdf/Patent-Marking.pdf. **onsemi** reserves the right to make changes at any time to any products or information herein, without notice. The information herein is provided "as-is" and **onsemi** makes no warranty, representation or guarantee regarding the accuracy of the information, product features, availability, functionality, or suitability of its products for any particular purpose, nor does **onsemi** assume any liability arising out of the application or use of any product or circuit, and specifically disclaims any and all liability, including without limitation special, consequential or incidental damages. Buyer is responsible for its products and applications using **onsemi** products, including compliance with all laws, regulations and safety requirements or standards, regardless of any support or applications information provided by **onsemi**. "Typical" parameters which may be provided in **onsemi** data sheets and/or specifications can and do vary in different applications and actual performance may vary over time. All operating parameters, including "Typicals" must be validated for each customer application by customer's technical experts. **onsemi** does not convey any license under any of its intellectual property rights nor the rights of others. **onsemi** products are not designed, intended, or authorized for use as a critical component in life support systems or any FDA Class 3 medical devices or medical devices with a same or similar classification in a foreign jurisdiction or any devices intended for implantation in the human body. Should Buyer purchase or use **onsemi** products for any such unintended or unauthorized application, Buyer shall indemnify and hold **onsemi** and its officers, employees, subsidiaries, affiliates, and distributors harmless against all claims, costs, damages, and expenses, and reasonable attorney fees arising out of, directly or indirectly, any claim of personal injury or death associated with such unintended or unauthorized use, even if such claim alleges that **onsemi** was negligent regarding the design or manufacture of the part. **onsemi** is an Equal Opportunity/Affirmative Action Employer. This literature is subject to all applicable copyright laws and is not for resale in any manner.

ADDITIONAL INFORMATION

TECHNICAL PUBLICATIONS:

Technical Library: www.onsemi.com/design/resources/technical-documentation
onsemi Website: www.onsemi.com

ONLINE SUPPORT: www.onsemi.com/support

For additional information, please contact your local Sales Representative at www.onsemi.com/support/sales