

# HBL5006 Series

## LED Shunt

The HBL5006 Series are electronic shunts which provide a current bypass in the case of LEDs going into open circuit. LEDs are by nature quite fragile when subjected to transients and surge conditions. There are also many cases where high reliability of the LED lighting must be maintained such as in headlights, lighthouses, bridges, aircraft, runways and so forth. In these cases the low cost addition of the shunt device will provide full assurance that an entire string of LEDs will not extinguish should one LED fail open. The shunt device is also applicable to other loads where circuit continuity is required. The devices are designed to be used with LED string currents from 50 to 350 mA.

### Features

- Protection for the Following IEC Standards:  
IEC 61000-4-2 (Level 4)  
ISO 10605
- Low ESD Clamping Voltage
- Automatically Resets Itself if the LED Heals Itself or is Replaced
- ON-State Voltage Typically 1.1 V
- OFF-State Current less than 1.0  $\mu$ A
- SZ Prefix for Automotive and Other Applications Requiring Unique Site and Control Change Requirements; AEC-Q101 Qualified and PPAP Capable
- These Devices are Pb-Free and are RoHS Compliant

### Typical Applications

- LEDs where Preventive Maintenance is Impractical
- LED Headlights in Automobiles
- Automotive LED Applications
- LEDs with High Reliability Requirements
- Crowbar Protection for Open Circuit Conditions
- Overvoltage Protection for Sensitive Circuits



**ON Semiconductor®**

[www.onsemi.com](http://www.onsemi.com)

### MARKING DIAGRAMS

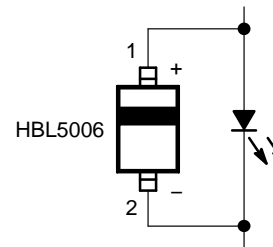
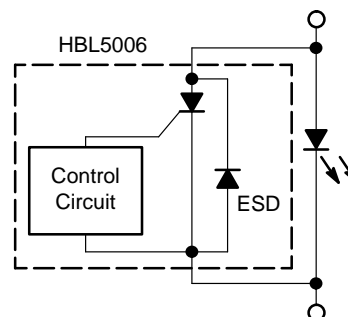
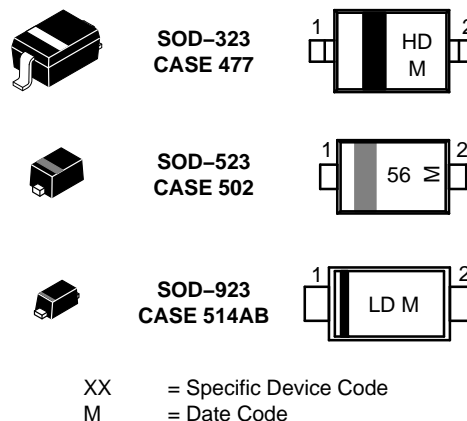

Apply heat sinking to pin 2

### ORDERING INFORMATION

See detailed ordering and shipping information in the package dimensions section on page 5 of this data sheet.

## HBL5006 Series

### MAXIMUM RATINGS

Rating		Symbol	Value	Unit
On-State Current, ( $T_A = 25^\circ\text{C}$ ) (Note 2)	SOD-323 (Note 1)	$I_{T(AVG)}$	250	mA
	SOD-323 (Note 2)		200	
	SOD-523 (Note 1)		300	
	SOD-523 (Note 2)		250	
	SOD-923 (Note 1)		350	
	SOD-923 (Note 2)		300	
Thermal Resistance, Junction-to-Air (All Packages)	SOD-323 (Note 1)	$\theta_{JA}$	435	$^\circ\text{C/W}$
	SOD-323 (Note 2)		550	
	SOD-523 (Note 1)		360	
	SOD-523 (Note 2)		435	
	SOD-923 (Note 1)		285	
	SOD-923 (Note 2)		360	
Operating Temperature Range	(Note 3)	$T_J$	-40 to 150	$^\circ\text{C}$
Non-Operating Temperature Range		$T_J$	150	$^\circ\text{C}$
Lead Temperature, Soldering (10 Sec)		$T_L$	260	$^\circ\text{C}$
IEC 61000-4-2 Contact (ESD)		ESD	$\pm 15$	kV
IEC 61000-4-2 Air (ESD)		ESD	$\pm 15$	

Stresses exceeding those listed in the Maximum Ratings table may damage the device. If any of these limits are exceeded, device functionality should not be assumed, damage may occur and reliability may be affected.

1. Mounted onto a 2-layer, 1000 mm<sup>2</sup> per layer, 3 oz Cu, FR4 PCB with pin 2 connected to the heat sink and pin 1 only connected to a signal trace. The heat sinking must be connected to pin 2, which is the LED cathode connection.

Normally this device would be mounted on the same copper heat sink and adjacent to the LED(s). If the LED(s) were to go open, then the HBL shunt would now dissipate the power using the same copper heat sink. Since the shunt has a voltage that is nominally 30% of the LED, then the power dissipation would be much lower, and easily handled by the same heat sink as the LED.

2. Mounted onto a 2-layer, 50 mm<sup>2</sup> per layer, 1 oz Cu, FR4 PCB.

3. Max operating temperature for DC conditions is 150 $^\circ\text{C}$ , but not to exceed 175 $^\circ\text{C}$  for pulsed conditions with low duty cycle or non-repetitive.

# HBL5006 Series

## ELECTRICAL CHARACTERISTICS (Unless otherwise noted: $T_A = 25^\circ\text{C}$ )

Symbol	Characteristics	Package	Min	Typ	Max	Unit
$V_{BR}$	Breakdown Voltage: The minimum voltage across the device in or at the breakdown region. Measured at $I_{BR} = 1 \text{ mA}$ .	SOD-323	6.2	7.0		V
		SOD-523	6.2	7.0		
		SOD-923	6.2	7.0		
$I_H$	Holding Current: The minimum current required to maintain the device in the on-state.	SOD-323		25	40	mA
		SOD-523		25	40	
		SOD-923		25	40	
$I_L$	Latching Current: The minimum current required to turn from the off-state to the on-state.	SOD-323		9.0		mA
		SOD-523		9.0		
		SOD-923		9.0		
$V_{BO}$	Breakover Voltage: The voltage across the device in the breakover region.	SOD-323	6.5	7.2	8.0	V
		SOD-523	6.5	7.2	8.0	
		SOD-923	6.5	7.2	8.0	
$I_R$	Off-State Current: The dc value of current that results from the application of the off-state voltage. Measured at 3.3 V.	SOD-323			1.0	$\mu\text{A}$
		SOD-523			1.0	
		SOD-923			1.0	
$V_T$	On-State Voltage. Measured at 100 mA.	SOD-323	0.9	1.1	1.3	V
		SOD-523	0.9	1.1	1.3	
		SOD-923	0.9	1.1	1.3	
$V_C$	Clamping Voltage TLP (Note 4)  $I_{PP} = 8 \text{ A}$ } IEC 6100-4-2 Level 2 equivalent (±4 kV Contact, ±4 kV Air)  $I_{PP} = 16 \text{ A}$ } IEC 6100-4-2 Level 4 equivalent (±8 kV Contact, ±15 kV Air)	SOD-323		6.5 11.2		V
		SOD-523		6.5 11.2		
		SOD-923		6.5 11.2		

Product parametric performance is indicated in the Electrical Characteristics for the listed test conditions, unless otherwise noted. Product performance may not be indicated by the Electrical Characteristics if operated under different conditions.

4. ANSI/ESD STM5.5.1 – Electrostatic Discharge Sensitivity Testing using Transmission Line Pulse (TLP) Model TLP conditions:  $Z_0 = 50 \Omega$ ,  $t_p = 100 \text{ ns}$ ,  $t_r = 4 \text{ ns}$ , averaging window;  $t_1 = 30 \text{ ns}$  to  $t_2 = 60 \text{ ns}$ .

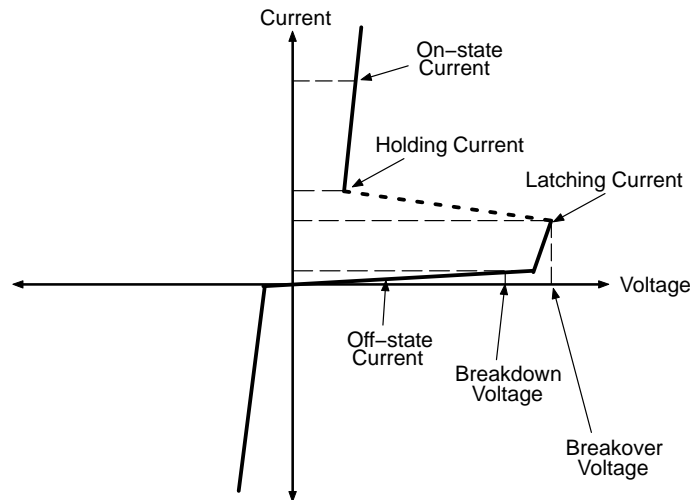

**Figure 1. I-V Characteristics**

# HBL5006 Series

## TYPICAL APPLICATION CIRCUIT

Typical Application Circuit for HBL5006

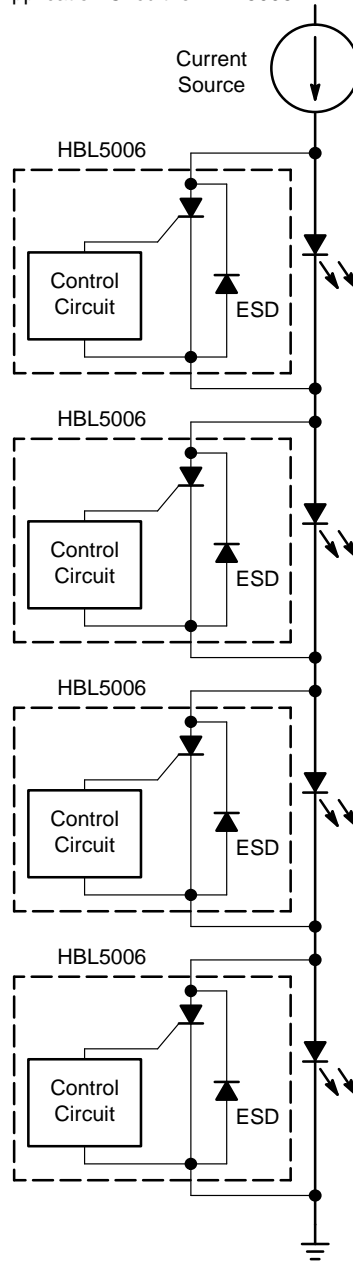

Figure 2. Typical Application Circuit

## HBL5006 Series

### DEVICE ORDERING INFORMATION

Device	Marking	Package	Shipping†
HBL5006HT1G	HD	SOD-323 (Pb-Free)	3000 / Tape & Reel
SZHBL5006HT1G*	HD		
HBL5006XV2T1G	56	SOD-523 (Pb-Free)	3000 / Tape & Reel
SZHBL5006XV2T1G*	56		
HBL5006XV2T5G	56		8000 / Tape & Reel
SZHBL5006XV2T5G*	56		
HBL5006P2T5G	LD	SOD-923 (Pb-Free)	8000 / Tape & Reel
SZHBL5006P2T5G*	LD		

†For additional information on our Pb-Free strategy and soldering details, please download the ON Semiconductor Soldering and Mounting Techniques Reference Manual, SOLDERRM/D.

\*SZ Prefix for Automotive and Other Applications Requiring Unique Site and Control Change Requirements; AEC-Q101 Qualified and PPAP Capable.

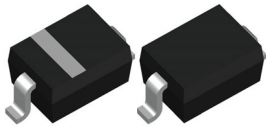

**SOD-323 1.70x1.25x0.85  
CASE 477  
ISSUE K**

DATE 11 MAR 2024

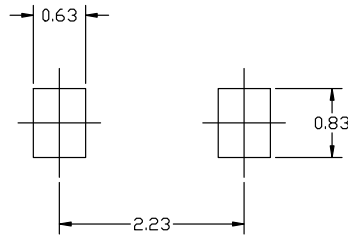
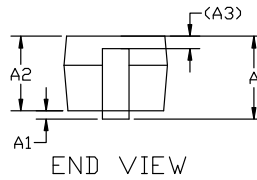
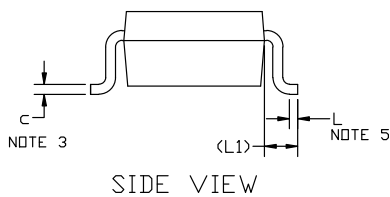
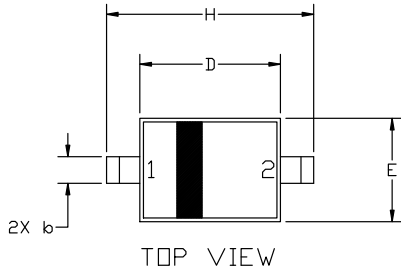

RECOMMENDED MOUNTING FOOTPRINT

\*For additional information on our Pb-Free strategy and soldering details, please download the ON Semiconductor Soldering and Mounting Techniques Reference manual, SOLDERRM/D.

NOTES:

1. DIMENSIONING AND TOLERANCING AS PER ASME Y14.5M, 2018.
2. CONTROLLING DIMENSION: MILLIMETERS.
3. LEAD THICKNESS SPECIFIED PER L/F DRAWING WITH SOLDER PLATING.
4. DIMENSIONS A AND B DO NOT INCLUDE MOLD FLASH, PROTRUSIONS OR GATE BURRS.
5. DIMENSION L IS MEASURE FROM END OF RADIUS.

DIM	MILLIMETERS		
	MIN.	NOM.	MAX.
A	0.80	0.90	1.00
A1	0.00	0.05	0.10
A2	0.75	0.85	0.95
A3	0.15 (REF)		
b	0.25	0.32	0.4
c	0.09	0.12	0.18
D	1.60	1.70	1.80
E	1.15	1.25	1.35
H	2.30	2.50	2.70
L	0.08	---	---
L1	0.40 (REF)		

**GENERIC MARKING DIAGRAM\***

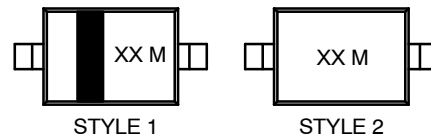

XX = Specific Device Code  
M = Date Code

\*This information is generic. Please refer to device data sheet for actual part marking. Pb-Free indicator, "G" or microdot "•", may or may not be present. Some products may not follow the Generic Marking.

STYLE 1: PIN 1. CATHODE (POLARITY BAND)  
2. ANODE                      STYLE 2: NO POLARITY

<b>DOCUMENT NUMBER:</b>	<b>98ASB17533C</b>	Electronic versions are uncontrolled except when accessed directly from the Document Repository. Printed versions are uncontrolled except when stamped "CONTROLLED COPY" in red.
<b>DESCRIPTION:</b>	<b>SOD-323 1.70x1.25x0.85</b>	<b>PAGE 1 OF 1</b>

onsemi and ONSEMI are trademarks of Semiconductor Components Industries, LLC dba onsemi or its subsidiaries in the United States and/or other countries. onsemi reserves the right to make changes without further notice to any products herein. onsemi makes no warranty, representation or guarantee regarding the suitability of its products for any particular purpose, nor does onsemi assume any liability arising out of the application or use of any product or circuit, and specifically disclaims any and all liability, including without limitation special, consequential or incidental damages. onsemi does not convey any license under its patent rights nor the rights of others.

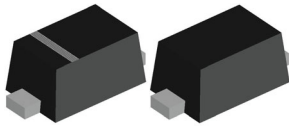

**SOD-523 1.20x0.80x0.60**  
**CASE 502**  
**ISSUE F**

DATE 08 FEB 2024

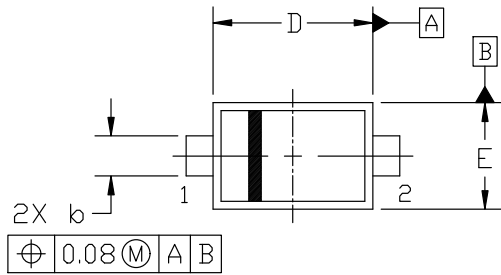

TOP VIEW

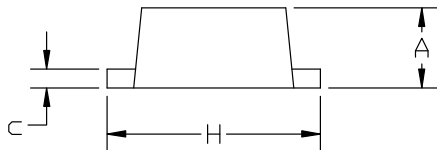

SIDE VIEW

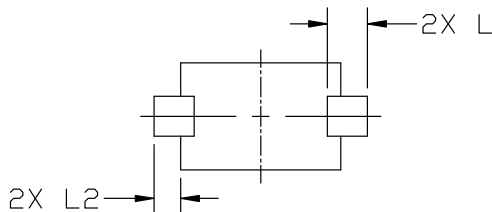

BOTTOM VIEW

**GENERIC MARKING DIAGRAM\***

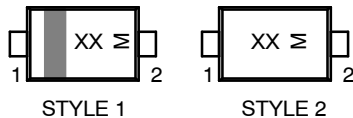

XX = Specific Device Code  
M = Date Code

\*This information is generic. Please refer to device data sheet for actual part marking. Pb-Free indicator, "G" or microdot "▪", may or may not be present. Some products may not follow the Generic Marking.

STYLE 1: PIN 1. CATHODE (POLARITY BAND)  
2. ANODE  
STYLE 2: NO POLARITY

NOTES:

1. DIMENSIONING AND TOLERANCING PER ASME Y14.5M, 2018.
2. CONTROLLING DIMENSION: MILLIMETERS.
3. MAXIMUM LEAD THICKNESS INCLUDES LEAD FINISH, MINIMUM LEAD THICKNESS IS THE MINIMUM THICKNESS OF BASE MATERIAL.
4. DIMENSIONS D AND E DO NOT INCLUDE MOLD FLASH, PROTRUSIONS, OR GATE BURRS.

DIM	MILLIMETERS		
	MIN.	NOM.	MAX.
A	0.50	0.60	0.70
b	0.25	0.30	0.35
c	0.07	0.14	0.20
D	1.10	1.20	1.30
E	0.70	0.80	0.90
H	1.50	1.60	1.70
L	0.30 REF		
L2	0.15	0.20	0.25

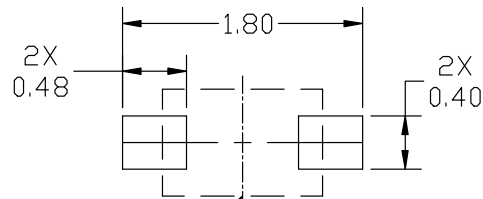

PACKAGE OUTLINE

**RECOMMENDED MOUNTING FOOTPRINT**

\*For additional information on our Pb-Free strategy and soldering details, please download the ON Semiconductor Soldering and Mounting Techniques Reference manual, SOLDERRM/D.

<b>DOCUMENT NUMBER:</b>	<b>98AON11524D</b>	Electronic versions are uncontrolled except when accessed directly from the Document Repository. Printed versions are uncontrolled except when stamped "CONTROLLED COPY" in red.
<b>DESCRIPTION:</b>	<b>SOD-523 1.20x0.80x0.60</b>	<b>PAGE 1 OF 1</b>

onsemi and onsemi are trademarks of Semiconductor Components Industries, LLC dba onsemi or its subsidiaries in the United States and/or other countries. onsemi reserves the right to make changes without further notice to any products herein. onsemi makes no warranty, representation or guarantee regarding the suitability of its products for any particular purpose, nor does onsemi assume any liability arising out of the application or use of any product or circuit, and specifically disclaims any and all liability, including without limitation special, consequential or incidental damages. onsemi does not convey any license under its patent rights nor the rights of others.

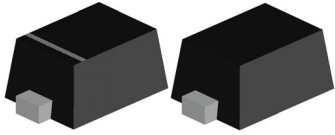

**SOD-923 0.80x0.60x0.37**  
**CASE 514AB**  
**ISSUE E**

DATE 08 FEB 2024

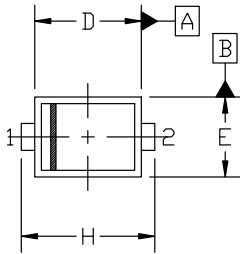

TOP VIEW

NOTES:

1. DIMENSIONING AND TOLERANCING PER ASME Y14.5M, 2018.
2. CONTROLLING DIMENSION: MILLIMETERS.
3. MAXIMUM LEAD THICKNESS INCLUDES LEAD FINISH. MINIMUM LEAD THICKNESS IS THE MINIMUM THICKNESS OF BASE MATERIAL.
4. DIMENSIONS D AND E DO NOT INCLUDE MOLD FLASH, PROTRUSIONS, OR GATE BURRS.
5. DIMENSION L WILL NOT EXCEED 0.30mm.

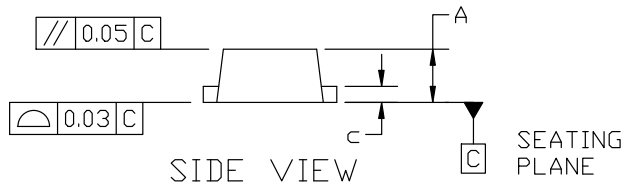

SIDE VIEW

SEATING PLANE

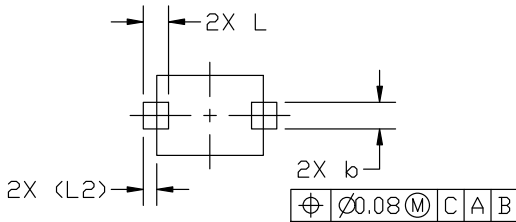

BOTTOM VIEW

MILLIMETERS			
DIM	MIN.	NOM.	MAX.
A	0.34	0.37	0.40
b	0.15	0.20	0.25
c	0.07	0.12	0.17
D	0.75	0.80	0.85
E	0.55	0.60	0.65
H	0.95	1.00	1.05
L	0.19 REF		
L2	0.05	0.10	0.15

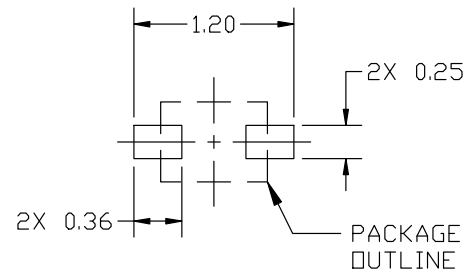

RECOMMENDED MOUNTING FOOTPRINT

**GENERIC MARKING DIAGRAM\***

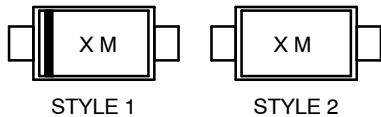

X = Specific Device Code  
M = Date Code

\*This information is generic. Please refer to device data sheet for actual part marking. Pb-Free indicator, "G" or microdot "▪", may or may not be present. Some products may not follow the Generic Marking.

STYLE 1: PIN 1. CATHODE (POLARITY BAND)  
2. ANODE

STYLE 2: NO POLARITY

\*For additional information on our Pb-Free strategy and soldering details, please download the ON Semiconductor Soldering and Mounting Techniques Reference Manual, SOLDERRM/D.

<b>DOCUMENT NUMBER:</b>	<b>98AON23284D</b>	Electronic versions are uncontrolled except when accessed directly from the Document Repository. Printed versions are uncontrolled except when stamped "CONTROLLED COPY" in red.
<b>DESCRIPTION:</b>	<b>SOD-923 0.80x0.60x0.37</b>	<b>PAGE 1 OF 1</b>

onsemi and ONSEMI are trademarks of Semiconductor Components Industries, LLC dba onsemi or its subsidiaries in the United States and/or other countries. onsemi reserves the right to make changes without further notice to any products herein. onsemi makes no warranty, representation or guarantee regarding the suitability of its products for any particular purpose, nor does onsemi assume any liability arising out of the application or use of any product or circuit, and specifically disclaims any and all liability, including without limitation special, consequential or incidental damages. onsemi does not convey any license under its patent rights nor the rights of others.



**onsemi**, **Onsemi**, and other names, marks, and brands are registered and/or common law trademarks of Semiconductor Components Industries, LLC dba "**onsemi**" or its affiliates and/or subsidiaries in the United States and/or other countries. **onsemi** owns the rights to a number of patents, trademarks, copyrights, trade secrets, and other intellectual property. A listing of **onsemi**'s product/patent coverage may be accessed at [www.onsemi.com/site/pdf/Patent-Marking.pdf](http://www.onsemi.com/site/pdf/Patent-Marking.pdf). **onsemi** reserves the right to make changes at any time to any products or information herein, without notice. The information herein is provided "as-is" and **onsemi** makes no warranty, representation or guarantee regarding the accuracy of the information, product features, availability, functionality, or suitability of its products for any particular purpose, nor does **onsemi** assume any liability arising out of the application or use of any product or circuit, and specifically disclaims any and all liability, including without limitation special, consequential or incidental damages. Buyer is responsible for its products and applications using **onsemi** products, including compliance with all laws, regulations and safety requirements or standards, regardless of any support or applications information provided by **onsemi**. "Typical" parameters which may be provided in **onsemi** data sheets and/or specifications can and do vary in different applications and actual performance may vary over time. All operating parameters, including "Typicals" must be validated for each customer application by customer's technical experts. **onsemi** does not convey any license under any of its intellectual property rights nor the rights of others. **onsemi** products are not designed, intended, or authorized for use as a critical component in life support systems or any FDA Class 3 medical devices or medical devices with a same or similar classification in a foreign jurisdiction or any devices intended for implantation in the human body. Should Buyer purchase or use **onsemi** products for any such unintended or unauthorized application, Buyer shall indemnify and hold **onsemi** and its officers, employees, subsidiaries, affiliates, and distributors harmless against all claims, costs, damages, and expenses, and reasonable attorney fees arising out of, directly or indirectly, any claim of personal injury or death associated with such unintended or unauthorized use, even if such claim alleges that **onsemi** was negligent regarding the design or manufacture of the part. **onsemi** is an Equal Opportunity/Affirmative Action Employer. This literature is subject to all applicable copyright laws and is not for resale in any manner.

## ADDITIONAL INFORMATION

### TECHNICAL PUBLICATIONS:

Technical Library: [www.onsemi.com/design/resources/technical-documentation](http://www.onsemi.com/design/resources/technical-documentation)  
onsemi Website: [www.onsemi.com](http://www.onsemi.com)

### ONLINE SUPPORT: [www.onsemi.com/support](http://www.onsemi.com/support)

For additional information, please contact your local Sales Representative at [www.onsemi.com/support/sales](http://www.onsemi.com/support/sales)