

Low-Voltage Dual-Supply 8-Bit Voltage Translator with Configurable Voltage Supplies and Signal Levels, 3-State Outputs, and Auto Direction Sensing

FXLA108

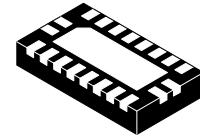

WQFN20 4.5x2.5, 0.5P
 CASE 510CD

MARKING DIAGRAM

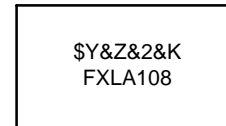

\$Y	= Logo
&Z	= Assembly Plant Code
&2	= 2-Digit Date Code
&K	= 2-Digits Lot Run Traceability Code
FXLA108	= Specific Device Code

Description

The FXLA108 is a configurable dual-voltage supply translator for both uni-directional and bi-directional voltage translation between two logic levels. The device allows translation between voltages as high as 3.6 V to as low as 1.1 V. The A port tracks the V_{CCA} level and the B port tracks the V_{CCB} level. This allows for bi-directional voltage translation over a variety of voltage levels: 1.2 V, 1.5 V, 1.8 V, 2.5 V, and 3.3 V.

The device remains in three-state as long as either $V_{CC} = 0$ V, allowing either V_{CC} to be powered up first. Internal power-down control circuits place the device in 3-state if either V_{CC} is removed.

The /OE input, when HIGH, disables both the A and B ports by placing them in a 3-state condition. The /OE input is supplied by V_{CCA} .

The FXLA108 supports bi-directional translation without the need for a direction control pin. The two ports of the device have auto-direction sense capability. Either port may sense an input signal and transfer it as an output signal to the other port.

Features

- Bi-Directional Interface Between Two Levels: from 1.1 V to 3.6 V
- Fully Configurable: Inputs and Outputs Track V_{CC}
- Non-Preferential Power-Up; Either V_{CC} May Be Powered Up First
- Outputs Switch to 3-State if Either V_{CC} is at GND
- Power-Off Protection
- Bus-Hold on Data Inputs Eliminates the Need for Pull-Up Resistors; Do Not Use Pull-Up Resistors on A or B Ports
- Control Input (/OE) Referenced to V_{CCA} Voltage
- Packaged in 20-Terminal DQFN (2.5 mm x 4.5 mm)
- Direction Control Not Necessary
- 100 Mbps Throughput when Translating Between 1.8 V and 2.5 V
- ESD Protection Exceeds:
 - ◆ 8 kV HBM (per JESD22-A114 & Mil Std 883e 3015.7)
 - ◆ 2 kV CDM (per ESD STM 5.3)
- This is a Pb-Free Device

Applications

- Laptops, Notebooks
- Routers, Switches

ORDERING INFORMATION

See detailed ordering and shipping information on page 15 of this data sheet.

FXLA108

PIN CONFIGURATION

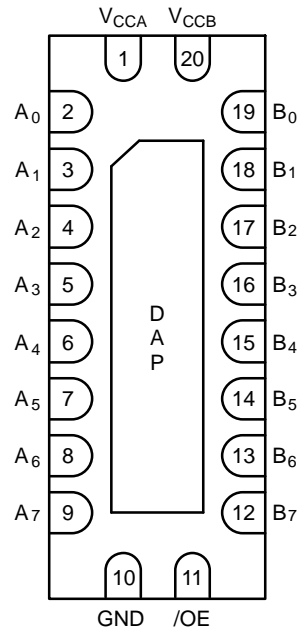

Figure 1. Pin Configuration (Top Through View)

PIN DEFINITIONS

Pin No.	Name	Description
1	V _{CCA}	A-Side Power Supply
2	A ₀	A-Side Inputs or 3-State Outputs
3	A ₁	A-Side Inputs or 3-State Outputs
4	A ₂	A-Side Inputs or 3-State Outputs
5	A ₃	A-Side Inputs or 3-State Outputs
6	A ₄	A-Side Inputs or 3-State Outputs
7	A ₅	A-Side Inputs or 3-State Outputs
8	A ₆	A-Side Inputs or 3-State Outputs
9	A ₇	A-Side Inputs or 3-State Outputs
10	GND	Ground
11	/OE	Output Enable Input
12	B ₇	B-Side Inputs or 3-State Outputs
13	B ₆	B-Side Inputs or 3-State Outputs
14	B ₅	B-Side Inputs or 3-State Outputs
15	B ₄	B-Side Inputs or 3-State Outputs
16	B ₃	B-Side Inputs or 3-State Outputs
17	B ₂	B-Side Inputs or 3-State Outputs
18	B ₁	B-Side Inputs or 3-State Outputs
19	B ₀	B-Side Inputs or 3-State Outputs
20	V _{CCB}	B-Side Power Supply
DAP	NC	No Connect

FXLA108

FUNCTIONAL DIAGRAM

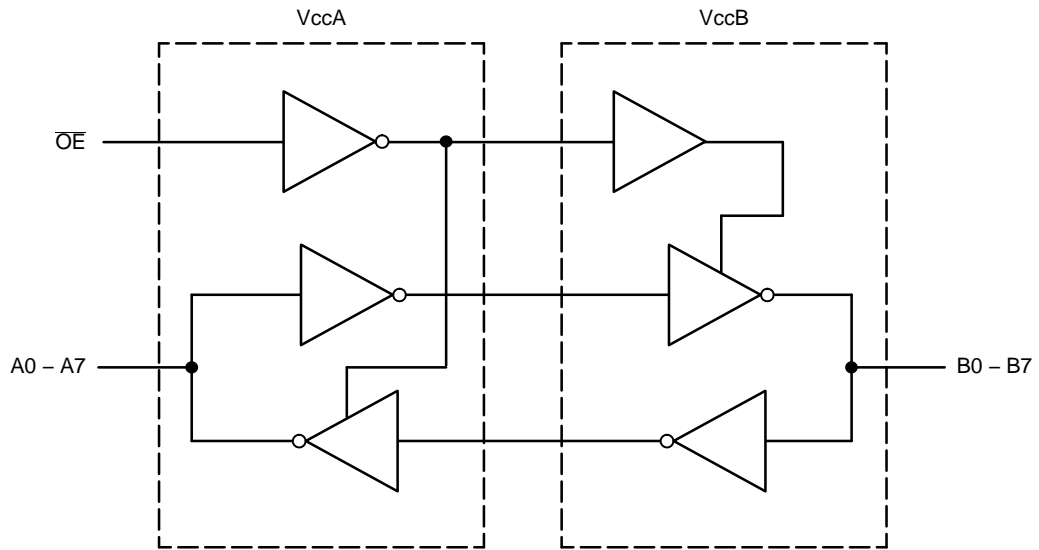

Figure 2. Functional Diagram

FUNCTION TABLE

Control		Outputs
/OE		
LOW Logic Level		Normal Operation
HIGH Logic Level		3-State

FXLA108

ABSOLUTE MAXIMUM RATINGS

Symbol	Parameter	Conditions	Min	Max	Unit
V _{CC}	Supply Voltage	V _{CCA}	-0.5	4.6	V
		V _{CCB}	-0.5	4.6	
V _I	DC Input Voltage	I/O Ports A and B	-0.5	4.6	V
		Control Input (/OE)	-0.5	4.6	
V _O	Output Voltage (Note 2)	Output 3-State	-0.5	4.6	V
		Output Active (A _n)	-0.5	V _{CCA} + 0.5	
		Output Active (B _n)	-0.5	V _{CCB} + 0.5	
I _{IK}	DC Input Diode Current	V _I < 0 V	-	-50	mA
I _{OK}	DC Output Diode Current	V _O < 0 V	-	-50	mA
		V _O > V _{CC}	-	+50	
I _{OH} /I _{OL}	DC Output Source/Sink Current		-50	+50	mA
I _{CC}	DC V _{CC} or Ground Current (Per Supply Pin)		-	±100	mA
T _{STG}	Storage Temperature Range		-65	+150	°C
P _D	Power Dissipation		-	35	mW
ESD	Human Body Model, JESD22-A114		-	8	kV
	Charged Device Model, JESD22-C101		-	2	

Stresses exceeding those listed in the Maximum Ratings table may damage the device. If any of these limits are exceeded, device functionality should not be assumed, damage may occur and reliability may be affected.

1. I_O absolute maximum ratings must be observed.
2. All unused inputs and input/outputs must be held at V_{CCi} or GND.

RECOMMENDED OPERATING CONDITIONS

Symbol	Parameter	Conditions	Min	Max	Unit
V _{CC}	Power Supply	Operating V _{CCA} or V _{CCB}	1.1	3.6	V
V _{IN}	Input Voltage	Ports A and B	0	3.6	V
		Control Input (/OE)	0	V _{CCA}	V
T _A	Operating Temperature, Free Air		-40	+85	°C
dt/dV	Minimum Input Edge Rate	V _{CCA/B} = 1.1 to 3.6 V	-	10	ns/V
θ _{JA}	Thermal Resistance: Junction-to-Ambient		-	50	°C/W
θ _{JC}	Thermal Resistance: Junction-to-Case		-	23	°C/W

Functional operation above the stresses listed in the Recommended Operating Ranges is not implied. Extended exposure to stresses beyond the Recommended Operating Ranges limits may affect device reliability.

POWER-UP/POWER-DOWN SEQUENCE

FXL translators offer an advantage in that either V_{CC} may be powered up first. This benefit derives from the chip design. When either V_{CC} is at 0 V, outputs are in a high-impedance state. The control input (/OE) is designed to track the V_{CCA} supply. A pull-up resistor tying /OE to V_{CCA} should be used to ensure that bus contention, excessive currents, or oscillations do not occur during power-up or power-down. The size of the pull-up resistor is based upon the current-sinking capability of the device driving the /OE pin.

The recommended power-up sequence is:

1. Apply power to the first V_{CC} .
2. Apply power to the second V_{CC} .
3. Drive the /OE input LOW to enable the device.

The recommended power-down sequence is:

1. Drive /OE input HIGH to disable the device.
2. Remove power from either V_{CC} .
3. Remove power from other V_{CC} .

Pull-Up/Pull-Down Resistors

Do not use pull-up or pull-down resistors. This device has bus-hold circuits: pull-up or pull-down resistors are not recommended because they interfere with the output state. The current through these resistors may exceed the hold drive, $I_{I(HOLD)}$ and/or $I_{I(OD)}$ bus-hold currents. The bus-hold feature eliminates the need for extra resistors.

FXLA108

DC CHARACTERISTICS (T_A = -40 to 85°C)

Symbol	Parameter	Conditions	V _{CCA} (V)	V _{CCB} (V)	Min	Typ	Max	Unit
V _{IHA}	High-Level Input Voltage	Data Inputs A _n Control Pin /OE	2.70 to 3.60	1.10 to 3.60	2.00	-	-	V
			2.30 to 2.70		1.60	-	-	
			1.65 to 2.30		0.65 x V _{CCA}	-	-	
			1.40 to 1.65		0.65 x V _{CCA}	-	-	
			1.10 to 1.40		0.9 x V _{CCA}	-	-	
V _{IHB}		Data Inputs B _n	1.10 to 3.60	2.70 to 3.60	2.00	-	-	V
			2.30 to 2.70		1.60	-	-	
			1.65 to 2.30		0.65 x V _{CCB}	-	-	
			1.40 to 1.65		0.65 x V _{CCB}	-	-	
			1.10 to 1.40		0.9 x V _{CCB}	-	-	
V _{ILA}	Low-Level Input Voltage	Data Inputs A _n Control Pin /OE	2.70 to 3.60	1.10 to 3.60	-	-	0.8	V
			2.30 to 2.70		-	-	0.7	
			1.65 to 2.30		-	-	0.35 x V _{CCA}	
			1.40 to 1.65		-	-	0.35 x V _{CCA}	
			1.10 to 1.40		-	-	0.1 x V _{CCA}	
V _{ILB}		Data Inputs B _n	1.10 to 3.60	2.70 to 3.60	-	-	0.8	V
			2.30 to 2.70		-	-	0.7	
			1.65 to 2.30		-	-	0.35 x V _{CCB}	
			1.40 to 1.65		-	-	0.35 x V _{CCB}	
			1.10 to 1.40		-	-	0.1 x V _{CCB}	
V _{OHA}	High-Level Output Voltage (Note 3)	I _{OH} = -4 μA	1.10 to 3.60	1.10 to 3.60	V _{CCA} - 0.4	-	-	V
V _{OHB}		I _{OH} = -4 μA	1.10 to 3.60	1.10 to 3.60	V _{CCB} - 0.4	-	-	
V _{OLA}	Low-Level Output Voltage (Note 3)	I _{OL} = 4 μA	1.10 to 3.60	1.10 to 3.60	-	-	0.4	V
V _{OLB}		I _{OL} = 4 μA	1.10 to 3.60	1.10 to 3.60	-	-	0.4	
I _{I(HOLD)}	Bus-Hold Input Minimum Drive Current	V _{IN} = 0.80 V	3.00	3.00	75.0	-	-	μA
		V _{IN} = 2.00 V	3.00	3.00	-75.0	-	-	
		V _{IN} = 0.7 V	2.30	2.30	45.0	-	-	
		V _{IN} = 1.60 V	2.30	2.30	-45.0	-	-	
		V _{IN} = 0.57 V	1.65	1.65	25.0	-	-	
		V _{IN} = 1.07 V	1.65	1.65	-25.0	-	-	
		V _{IN} = 0.49 V	1.40	1.40	11.0	-	-	
		V _{IN} = 0.91 V	1.40	1.40	-11.0	-	-	
		V _{IN} = 0.11 V	1.10	1.10	-	4.0	-	
		V _{IN} = 0.99 V	1.10	1.10	-	-4.0	-	
I _{I(ODH)}	Bus-Hold Input Overdrive High Current (Note 4)	Data Inputs A _n , B _n	3.60	3.60	450.00	-	-	μA
			2.70	2.70	300.00	-	-	
			1.95	1.95	200.00	-	-	
			1.60	1.60	120.00	-	-	
			1.40	1.40	80.00	-	-	

FXLA108

DC CHARACTERISTICS (T_A = -40 to 85°C) (continued)

Symbol	Parameter	Conditions	V _{CCA} (V)	V _{CCB} (V)	Min	Typ	Max	Unit
I _{I(ODL)}	Bus-Hold Input Overdrive Low Current (Note 5)	Data Inputs A _n , B _n	3.60	3.60	-450.00	-	-	μA
			2.70	2.70	-300.00	-	-	
			1.95	1.95	-200.00	-	-	
			1.60	1.60	-120.00	-	-	
			1.40	1.40	-80.00	-	-	
I _I	Input Leakage Current	Control Inputs /OE, V _I = V _{CCA} or GND	1.10 to 3.60	3.60	-	-	±1.0	μA
I _{OFF}	Power-Off Leakage Current	A _n V _O = 0 V to 3.6 V	0	3.6	-	-	±2.0	μA
		B _n V _O = 0 V to 3.6 V	3.60	0	-	-	±2.0	
I _{OZ}	3-State Output Leakage	A _n , B _n V _O = 0 V or 3.6 V, /OE = V _{IH}	3.6	3.60	-	-	±5.0	μA
		A _n V _O = 0 V or 3.6 V, /OE = GND	3.60	0	-	-	±5.0	
		B _n V _O = 0 V or 3.6 V, /OE = GND	0	3.60	-	-	±5.0	
I _{CCA/B}	Quiescent Supply Current (Note 6, 7)	V _I = V _{CCI} or GND; I _O = 0, /OE = GND	1.10 to 3.60	1.10 to 3.60	-	-	10.0	μA
I _{CCZ}		V _I = V _{CCI} or GND; I _O = 0, /OE = V _{IH}	1.10 to 3.60	1.10 to 3.60	-	-	10.0	μA
I _{CCA}	Quiescent Supply Current	V _I = V _{CCB} or GND; I _O = 0 B-to-A Direction, /OE = GND	0	1.10 to 3.60	-	-	-10.0	μA
		V _I = V _{CCA} or GND; I _O = 0 A-to-B Direction	1.10 to 3.60	0	-	-	10.0	
I _{CCB}	Quiescent Supply Current	V _I = V _{CCA} or GND; I _O = 0, A-to-B Direction, /OE = GND	1.10 to 3.60	0	-	-	-10.0	μA
		V _I = V _{CCB} or GND; I _O = 0 B-to-A Direction	0	1.10 to 3.60	-	-	10.0	

3. This is the output voltage for static conditions. Dynamic drive specifications are given in the Dynamic Output Electrical Characteristics table.
4. An external drive must source at least the specified current to switch LOW-to-HIGH.
5. An external drive must source at least the specified current to switch HIGH-to-LOW.
6. V_{CCI} is the V_{CC} associated with the input side.
7. Reflects current per supply, V_{CCA} or V_{CCB}.

FXLA108

DYNAMIC OUTPUT ELECTRICAL CHARACTERISTICS

Symbol	Parameter	V _{CCA} = 3.0 V to 3.6 V		V _{CCA} = 2.3 V to 2.7 V		V _{CCA} = 1.65 V to 1.95 V		V _{CCA} = 1.4 V to 1.6 V		V _{CCA} = 1.1 V to 1.3 V	Unit
		Typ	Max	Typ	Max	Typ	Max	Typ	Max	Typ	

A PORT (A_n)

OUTPUT LOAD: C_L = 15 pF, R_L ≥ 1 MΩ (C_{I/O} = 4 pF), T_A = -40 to 85°C

t _{rise}	Output Rise Time A Port (Note 9)	-	3.0	-	3.5	-	4.0	-	5.0	7.5	ns
t _{fall}	Output Fall Time A Port (Note 10)	-	3.0	-	3.5	-	4.0	-	5.0	7.5	ns
I _{OHD}	Dynamic Output Current High (Note 9)	-11.4	-	-7.5	-	-4.7	-	-3.2	-	-1.7	mA
I _{OLD}	Dynamic Output Current Low (Note 10)	+11.4	-	+7.5	-	+4.7	-	+3.2	-	+1.7	mA

B PORT (B_n)

OUTPUT LOAD: C_L = 15 pF, R_L ≥ 1 MΩ (C_{I/O} = 5 pF), T_A = -40 to 85°C

t _{rise}	Output Rise Time B Port (Note 9)	-	3.0	-	3.5	-	4.0	-	5.0	7.5	ns
t _{fall}	Output Fall Time B Port (Note 10)	-	3.0	-	3.5	-	4.0	-	5.0	7.5	ns
I _{OHD}	Dynamic Output Current High (Note 9)	-12.0	-	-7.9	-	-5.0	-	-3.4	-	-1.8	mA
I _{OLD}	Dynamic Output Current Low (Note 10)	+12.0	-	+7.9	-	+5.0	-	+3.4	-	+1.8	mA

8. Dynamic output characteristics are guaranteed, but not tested.

9. See Figure 7.

10. See Figure 8.

FXLA108

AC CHARACTERISTICS

Symbol	Parameter	V _{CCB} = 3.0 V to 3.6 V		V _{CCB} = 2.3 V to 2.7 V		V _{CCB} = 1.65 V to 1.95 V		V _{CCB} = 1.4 V to 1.6 V		V _{CCB} = 1.1 V to 1.3 V		Unit
		Typ	Max	Typ	Max	Typ	Max	Typ	Max	Typ	Max	

V_{CCA} = 3.0 V to 3.6 V, T_A = -40 to 85°C

t _{PLH} , t _{PHL}	A to B	0.2	4.0	0.3	4.2	0.5	5.4	0.6	6.8	6.9	ns
	B to A	0.2	4.0	0.2	4.1	0.3	5.0	0.5	6.0	4.5	ns
t _{PZL} , t _{PZH}	/OE to A, /OE to B	–	1.7	–	1.7	–	1.7	–	1.7	1.7	μs
t _{SKEW}	A Port, B Port (Note 11)	–	0.5	–	0.5	–	0.5	–	1.0	1.0	ns

V_{CCA} = 2.3 V to 2.7 V, T_A = -40 to 85°C

t _{PLH} , t _{PHL}	A to B	0.2	4.1	0.4	4.5	0.5	5.6	0.8	6.9	7.0	ns
	B to A	0.3	4.2	0.4	4.5	0.5	5.5	0.5	6.5	4.8	ns
t _{PZL} , t _{PZH}	/OE to A, /OE to B	–	1.7	–	1.7	–	1.7	–	1.7	1.7	μs
t _{SKEW}	A Port, B Port (Note 11)	–	0.5	–	0.5	–	0.5	–	1.0	1.0	ns

V_{CCA} = 1.65 V to 1.95 V, T_A = -40 to 85°C

t _{PLH} , t _{PHL}	A to B	0.3	5.0	0.5	5.5	0.8	6.7	0.9	7.5	7.5	ns
	B to A	0.5	5.4	0.5	5.6	0.8	6.7	1.0	7.0	5.4	ns
t _{PZL} , t _{PZH}	/OE to A, /OE to B	–	1.7	–	1.7	–	1.7	–	1.7	1.7	μs
t _{SKEW}	A Port, B Port (Note 11)	–	0.5	–	0.5	–	0.5	–	1.0	1.0	ns

V_{CCA} = 1.4 V to 1.6 V, T_A = -40 to 85°C

t _{PLH} , t _{PHL}	A to B	0.5	6.0	0.5	6.5	1.0	7.0	1.0	8.5	7.9	ns
	B to A	0.6	6.8	0.8	6.9	0.9	7.5	1.0	8.5	6.1	ns
t _{PZL} , t _{PZH}	/OE to A, /OE to B	–	1.7	–	1.7	–	1.7	–	1.7	1.7	μs
t _{SKEW}	A Port, B Port (Note 12)	–	1.0	–	1.0	–	1.0	–	1.0	1.0	ns

V_{CCA} = 1.1 V to 1.3 V, T_A = -40 to 85°C

		Typ	Typ	Typ	Typ	Typ	Typ	Typ	Typ	Typ	
t _{PLH} , t _{PHL}	A to B	4.6	4.8	5.4	6.2	9.2	ns				
	B to A	6.8	7.0	7.4	7.8	9.1	ns				
t _{PZL} , t _{PZH}	/OE to A, /OE to B	1.7	1.7	1.7	1.7	1.7	μs				
t _{SKEW}	A Port, B Port (Note 12)	1.0	1.0	1.0	1.0	1.0	ns				

11. Skew is the variation of propagation delay between output signals and applies only to output signals on the same port (A_n or B_n) and switching with the same polarity (LOW-to-HIGH or HIGH-to-LOW) (see Figure 10).

Skew is guaranteed, but not tested.

12. Skew is the variation of propagation delay between output signals and applies only to output signals on the same port (A_n or B_n) and switching with the same polarity (LOW-to-HIGH or HIGH-to-LOW) (see Figure 10).

Skew is guaranteed, but not tested.

FXLA108

MAXIMUM DATA RATE ($T_A = -40$ to 85°C)

V_{CCA}	$V_{CCB} = 3.0\text{ V}$ to 3.6 V	$V_{CCB} = 2.3\text{ V}$ to 2.7 V	$V_{CCB} = 1.65\text{ V}$ to 1.95 V	$V_{CCB} = 1.4\text{ V}$ to 1.6 V	$V_{CCB} = 1.1\text{ V}$ to 1.3 V	Unit
	Min	Min	Min	Min	Typ	
$V_{CCA} = 3.00\text{ V}$ to 3.60 V	140	120	100	80	40	Mbps
$V_{CCA} = 2.30\text{ V}$ to 2.70 V	120	120	100	80	40	Mbps
$V_{CCA} = 1.65\text{ V}$ to 1.95 V	100	100	80	60	40	Mbps
$V_{CCA} = 1.40\text{ V}$ to 1.60 V	80	80	60	60	40	Mbps
	Typ	Typ	Typ	Typ	Typ	
$V_{CCA} = 1.10\text{ V}$ to 1.30 V	40	40	40	40	40	Mbps

13. Maximum data rate is guaranteed, but not tested.

14. Maximum data rate is specified in megabits per second (see Figure 9). It is equivalent to two times the F-toggle frequency, specified in megahertz. For example, 100 Mbps is equivalent to 50 MHz.

CAPACITANCE

Symbol	Parameter	Conditions	$T_A = +25^\circ\text{C}$ Typical	Unit	
C_{IN}	Input Capacitance Control Pin (/OE)	$V_{CCA} = V_{CCB} = \text{GND}$	3	pF	
$C_{I/O}$	Input/Output Capacitance	$V_{CCA} = V_{CCB} = 3.3\text{ V}$, /OE = V_{CCA}	A_n	4	pF
			B_n	5	
C_{pd}	Power Dissipation Capacitance	$V_{CCA} = V_{CCB} = 3.3\text{ V}$, $V_I = 0\text{ V}$ or V_{CC} , $f = 10\text{ MHz}$	25	pF	

FXLA108

I/O ARCHITECTURE BENEFIT

The FXLA108 I/O architecture benefits the end user, beyond level translation, in the following three ways:

Auto Direction without an external direction pin.

Drive Capacitive Loads. Automatically shifts to a higher current drive mode only during “Dynamic Mode” or HL / LH transitions.

Lower Power Consumption. Automatically shifts to low-power mode during “Static Mode” (no transitions), lowering power consumption.

The FXLA108 does not require a direction pin. Instead, the I/O architecture detects input transitions on both side and automatically transfers the data to the corresponding output. For example, for a given channel, if both A and B side are at a static LOW, the direction has been established as A → B, and a LH transition occurs on the B port; the FXLA108 internal I/O architecture automatically changes direction from A → B to B → A.

During HL / LH transitions, or “Dynamic Mode,” a strong output driver drives the output channel in parallel with a weak output driver. After a typical delay of approximately 10 ns – 50 ns, the strong driver is turned off, leaving the weak driver enabled for holding the logic state of the channel. This weak driver is called the “bus hold.” “Static Mode” is when

only the bus hold drives the channel. The bus hold can be overridden in the event of a direction change. The strong driver allows the FXLA108 to quickly charge and discharge capacitive transmission lines during dynamic mode. Static mode conserves power, where I_{CC} is typically $< 5 \mu A$.

Bus Hold Minimum Drive Current

Specifies the minimum amount of current the bus hold driver can source/sink. The bus hold minimum drive current (I_{HOLD}) is V_{CC} dependent and guaranteed in the DC Electrical tables. The intent is to maintain a valid output state in a static mode, but that can be overridden when an input data transition occurs.

Bus Hold Input Overdrive Drive Current

Specifies the minimum amount of current required (by an external device) to overdrive the bus hold in the event of a direction change. The bus hold overdrive (I_{ODH} , I_{ODL}) is V_{CC} dependent and guaranteed in the DC Electrical tables.

Dynamic Output Current

The strength of the output driver during LH / HL transitions is *referenced on page 8, Dynamic Output Electrical Characteristics, I_{OHD} , and I_{OLD} .*

FXLA108

TEST DIAGRAMS

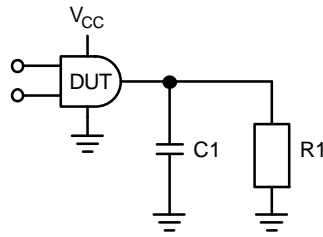

Figure 3. Test Circuit

Table 1. AC TEST CONDITIONS

Test	Input Signal	Output Enable Control
t_{PLH} , t_{PHL}	Data Pulses	0 V
t_{PZL}	0 V	HIGH to LOW Switch
t_{PZH}	V_{CC1}	HIGH to LOW Switch

Table 2. AC LOAD

V_{CC0}	C1	R1
1.2 V \pm 0.1 V	15 pF	1 M Ω
1.5 V \pm 0.1 V	15 pF	1 M Ω
1.8 V \pm 0.15 V	15 pF	1 M Ω
2.5 V \pm 0.2 V	15 pF	1 M Ω
3.3 V \pm 0.3 V	15 pF	1 M Ω

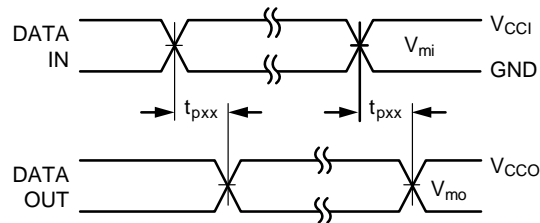

NOTES:

15. Input $t_R = t_F = 2.0$ ns, 10% to 90%.

16. Input $t_R = t_F = 2.5$ ns, 10% to 90%, at $V_I = 3.0$ V to 3.6 V only.

Figure 4. Waveform for Inverting and Non-Inverting Functions

FXLA108

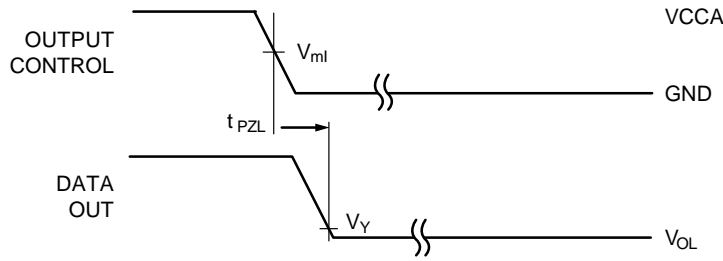

NOTES:

- 17. Input $t_R = t_F = 2.0$ ns, 10% to 90%.
- 18. Input $t_R = t_F = 2.5$ ns, 10% to 90%, at $V_I = 3.0$ V to 3.6 V only.

Figure 5. 3-State Output Low Enable Time for Low Voltage Logic

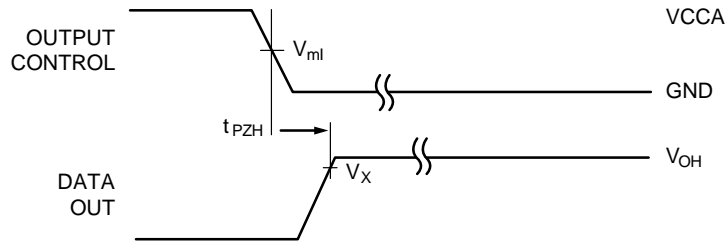

NOTES:

- 19. Input $t_R = t_F = 2.0$ ns, 10% to 90%.
- 20. Input $t_R = t_F = 2.5$ ns, 10% to 90%, at $V_I = 3.0$ V to 3.6 V only.

Figure 6. 3-State Output High Enable Time for Low Voltage Logic

Table 3. TEST MEASURE POINTS

Symbol	V _{DD}
V _{MI} (Note 21)	V _{CCI} / 2
V _{MO}	V _{CCO} / 2
V _X	0.9 x V _{CCO}
V _Y	0.1 x V _{CCO}

21. V_{CCI} = V_{CCA} for control pin /OE or V_{MI} = (V_{CCA} / 2).

FXLA108

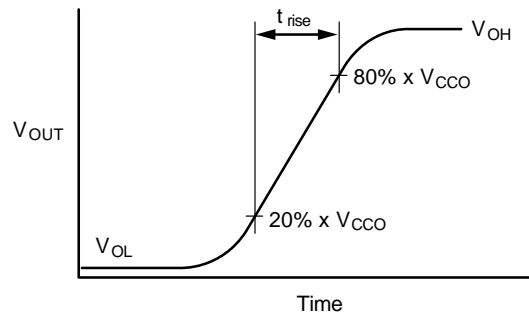

$$I_{OHD} \approx (C_L + C_{I/O}) \times \frac{\Delta V_{OUT}}{\Delta t} = (C_L + C_{I/O}) \times \frac{(20\% - 80\%) \cdot V_{CCO}}{t_{RISE}}$$

Figure 7. Active Output Rise Time and Dynamic Output Current High

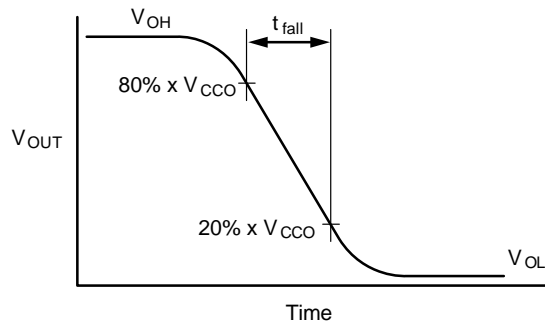

$$I_{OLD} \approx (C_L + C_{I/O}) \times \frac{\Delta V_{OUT}}{\Delta t} = (C_L + C_{I/O}) \times \frac{(80\% - 20\%) \cdot V_{CCO}}{t_{FALL}}$$

Figure 8. Active Output Fall Time and Dynamic Output Current Low

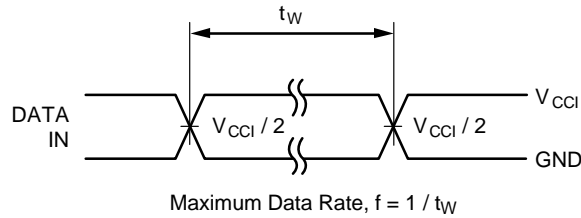
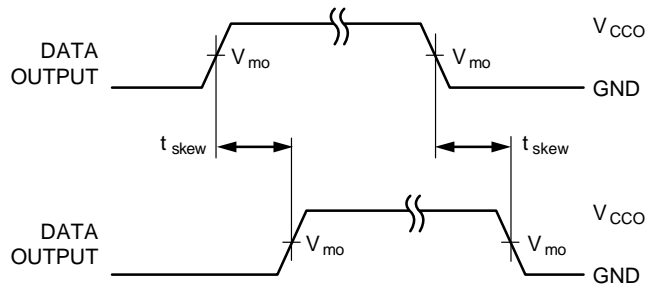

Figure 9. Maximum Data Rate



NOTE:

22. $t_{SKEW} = (t_{PHLmax} - t_{PHLmin})$ OR $(t_{PLHmax} - t_{PLHmin})$

Figure 10. Output Skew Time

FXLA108

ORDERING INFORMATION

Part Number	Operating Temperature Range	Package	Shipping†
FXLA108BQX	-40 to 85°C	WQFN20 4.5x2.5, 0.5P 20-Terminal DQFN 2.5mm x 4.5mm Package (Pb-Free)	3000 / Tape & Reel

†For information on tape and reel specifications, including part orientation and tape sizes, please refer to our Tape and Reel Packaging Specifications Brochure, BRD8011/D.

onsemi, **Onsemi**, and other names, marks, and brands are registered and/or common law trademarks of Semiconductor Components Industries, LLC dba "**onsemi**" or its affiliates and/or subsidiaries in the United States and/or other countries. **onsemi** owns the rights to a number of patents, trademarks, copyrights, trade secrets, and other intellectual property. A listing of **onsemi**'s product/patent coverage may be accessed at www.onsemi.com/site/pdf/Patent-Marking.pdf. **onsemi** reserves the right to make changes at any time to any products or information herein, without notice. The information herein is provided "as-is" and **onsemi** makes no warranty, representation or guarantee regarding the accuracy of the information, product features, availability, functionality, or suitability of its products for any particular purpose, nor does **onsemi** assume any liability arising out of the application or use of any product or circuit, and specifically disclaims any and all liability, including without limitation special, consequential or incidental damages. Buyer is responsible for its products and applications using **onsemi** products, including compliance with all laws, regulations and safety requirements or standards, regardless of any support or applications information provided by **onsemi**. "Typical" parameters which may be provided in **onsemi** data sheets and/or specifications can and do vary in different applications and actual performance may vary over time. All operating parameters, including "Typicals" must be validated for each customer application by customer's technical experts. **onsemi** does not convey any license under any of its intellectual property rights nor the rights of others. **onsemi** products are not designed, intended, or authorized for use as a critical component in life support systems or any FDA Class 3 medical devices or medical devices with a same or similar classification in a foreign jurisdiction or any devices intended for implantation in the human body. Should Buyer purchase or use **onsemi** products for any such unintended or unauthorized application, Buyer shall indemnify and hold **onsemi** and its officers, employees, subsidiaries, affiliates, and distributors harmless against all claims, costs, damages, and expenses, and reasonable attorney fees arising out of, directly or indirectly, any claim of personal injury or death associated with such unintended or unauthorized use, even if such claim alleges that **onsemi** was negligent regarding the design or manufacture of the part. **onsemi** is an Equal Opportunity/Affirmative Action Employer. This literature is subject to all applicable copyright laws and is not for resale in any manner.

ADDITIONAL INFORMATION

TECHNICAL PUBLICATIONS:

Technical Library: www.onsemi.com/design/resources/technical-documentation
onsemi Website: www.onsemi.com

ONLINE SUPPORT: www.onsemi.com/support

For additional information, please contact your local Sales Representative at www.onsemi.com/support/sales