

IntelliMAX™ Advanced Load Management Products

FPF2108 - FPF2110

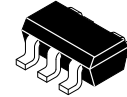

SOT-23, 5 Lead
CASE 527AH

General Description

The FPF2108–FPF2110 is a series of load switches which provides full protection to systems and loads which may encounter large current conditions. This devices contain a 0.125 Ω current–limited P–channel MOSFET which can operate over an input voltage range of 1.8 V–5.5 V. Internally, reverse current blocking prevents current from flowing when the MOSFET is off and the output voltage is higher than the input voltage. Switch control is by a logic input (ON) capable of interfacing directly with low voltage control signals. Each part contains thermal shutdown protection which shuts off the switch to prevent damage to the part when a continuous over–current condition causes excessive heating.

When the switch current reaches the current limit, the part operates in a constant–current mode to prohibit excessive currents from causing damage. For the FPF2108, if the constant current condition still persists after 10 ms, the part will shut off the switch and pull the fault signal pin (FLAGB) low. The switch will remain off until the ON pin is cycled. For the FPF2109 and FPF2110, a current limit condition will immediately pull the fault signal pin low and the part will remain in the constant–current mode until the switch current falls below the current limit. The minimum current limit is 200 mA for the FPF2109 while that for the FPF2108 and FPF2110 is 400 mA.

These parts are available in a space–saving 5 pin SOT23 package.

Features

- 1.8 V to 5.5 V Input Voltage Range
- Controlled Turn–On
- 200 mA and 400 mA Current Limit Options
- Undervoltage Lockout
- Thermal Shutdown
- <2 μA Shutdown Current
- Fast Current Limit Response Time
 - ◆ 3 μs to Moderate Over Currents
 - ◆ 20 ns to Hard Shorts
- Reverse Current Blocking
- Fault Blanking
- These Devices are Pb–Free and Halide Free and are RoHS Compliant

Applications

- PDAs
- Cell Phones
- GPS Devices
- MP3 Players
- Digital Cameras
- Peripheral Ports
- Hot Swap Supplies

MARKING DIAGRAM

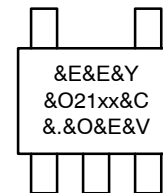

- &E = Designates Space
- &Y = Binary Calendar Year Coding Scheme
- &O = Plant Code Identifier
- 21xx = Device Specific Code
- xx = 08, 09 or 10
- &C = Single Digit Die Run Code
- &. = Pin One Dot
- &V = Eight–Week Binary Datecoding Scheme

ORDERING INFORMATION

See detailed ordering and shipping information on page 11 of this data sheet.

FPF2108 – FPF2110

PIN CONFIGURATION

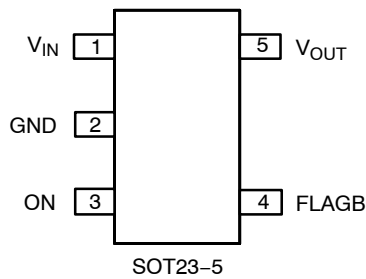

Figure 3. Pin Configuration

PIN DESCRIPTION

Pin	Name	Description
1	V _{IN}	Supply Input: Input to the power switch and the supply voltage for the IC
2	GND	Ground
3	ON	ON Control Input
4	FLAGB	Fault Output: Active LO, open drain output which indicates an over current supply, under voltage or over temperature state.
5	V _{OUT}	Switch Output: Output of the power switch

ABSOLUTE MAXIMUM RATINGS

Parameter	Min	Max	Unit	
V _{IN} , V _{OUT} , ON, FLAGB to GND	-0.3	6	V	
Power Dissipation @ T _A = 25°C (Note 1)	-	667	mW	
Operating Temperature Range	-40	125	°C	
Storage Temperature	-65	150	°C	
Thermal Resistance, Junction to Ambient	-	150	°C/W	
Electrostatic Discharge Protection	HBM	4000	-	V
	MM	400	-	V

Stresses exceeding those listed in the Maximum Ratings table may damage the device. If any of these limits are exceeded, device functionality should not be assumed, damage may occur and reliability may be affected.

1. Package power dissipation on 1square inch pad, 2 oz copper board.

RECOMMENDED OPERATING CONDITIONS

Symbol	Parameter	Min	Max	Unit
V _{IN}	Input Voltage	1.8	5.5	V
T _A	Ambient Operating Temperature	-40	85	°C

Functional operation above the stresses listed in the Recommended Operating Ranges is not implied. Extended exposure to stresses beyond the Recommended Operating Ranges limits may affect device reliability.

FPF2108 – FPF2110

ELECTRICAL CHARACTERISTICS

($V_{IN} = 1.8$ to 5.5 V, $T_A = -40^\circ\text{C}$ to $+85^\circ\text{C}$ unless otherwise noted. Typical values are $V_{IN} = 3.3$ V and $T_A = 25^\circ\text{C}$.)

Symbol	Parameter	Test Conditions	Min	Typ	Max	Unit
V_{IN}	Operating Voltage		1.8	–	5.5	V
I_Q	Quiescent Current	$I_{OUT} = 0$ mA Von active	$V_{IN} = 1.8$ V to 3.3 V $V_{IN} = 3.3$ V to 5.5 V	– 95	– 200	μA
I_{SHDN}	Shutdown Current		–	–	2	μA
I_{BLOCK}	Reverse Block Leakage Current		–	–	1	μA
$I_{LATCHOFF}$	Latch-Off Current (Note 2)	$V_{ON} = V_{IN}$, after an over-current fault	–	50	–	μA
R_{ON}	On-Resistance	$V_{IN} = 3.3$ V, $I_{OUT} = 50$ mA, $T_A = 25^\circ\text{C}$	–	125	160	$\text{m}\Omega$
		$V_{IN} = 3.3$ V, $I_{OUT} = 50$ mA, $T_A = 85^\circ\text{C}$	–	150	200	
		$V_{IN} = 3.3$ V, $I_{OUT} = 50$ mA, $T_A = -40^\circ\text{C}$ to 85°C	65	–	200	
V_{IH}	ON Input Logic High Voltage	$V_{IN} = 1.8$ V	0.75	–	–	V
		$V_{IN} = 5.5$ V	1.30	–	–	
V_{IL}	ON Input Logic Low Voltage	$V_{IN} = 1.8$ V	–	–	0.5	V
		$V_{IN} = 5.5$ V	–	–	1.0	
	ON Input Leakage	$V_{ON} = V_{IN}$ or GND	–	–	1	μA
I_{SWOFF}	Off Switch Leakage	$V_{ON} = 0$ V, $V_{OUT} = 0$ V	–	–	1	μA
	FLAGB Output Logic Low Voltage	$V_{IN} = 5$ V, $I_{SINK} = 10$ mA	–	0.1	0.2	V
		$V_{IN} = 1.8$ V, $I_{SINK} = 10$ mA	–	0.15	0.3	
	FLAGB Output High Leakage Current	$V_{IN} = 5$ V, Switch on	–	–	1	μA

PROTECTIONS

I_{LIM}	Current Limit	$V_{IN} = 3.3$ V, $V_{OUT} = 3.0$ V	FPF2109	200	300	400	mA
			FPF2108, FPF2110	400	600	800	
	Thermal Shutdown	Shutdown Threshold	–	140	–	$^\circ\text{C}$	
		Return from Shutdown	–	130	–		
		Hysteresis	–	10	–		
UVLO	Under Voltage Shutdown	V_{IN} Increasing	1.5	1.6	1.7	V	
	Under Voltage Shutdown Hysteresis		–	47	–	mV	

DYNAMIC

t_{ON}	Turn On Time	$R_L = 500$ Ω , $C_L = 0.1$ μF	–	25	–	μs
t_{OFF}	Turn Off Time	$R_L = 500$ Ω , $C_L = 0.1$ μF	–	50	–	μs
t_R	V_{OUT} Rise Time	$R_L = 500$ Ω , $C_L = 0.1$ μF	–	12	–	μs
t_F	V_{OUT} Fall Time	$R_L = 500$ Ω , $C_L = 0.1$ μF	–	136	–	μs
t_{BLANK}	Over Current Blanking Time	FPF2108	5	10	20	ms
	Short Circuit Response Time	$V_{IN} = V_{ON} = 3.3$ V. Moderate Over-Current Condition.	–	3	–	μs
		$V_{IN} = V_{ON} = 3.3$ V. Hard Short.	–	20	–	ns

Product parametric performance is indicated in the Electrical Characteristics for the listed test conditions, unless otherwise noted. Product performance may not be indicated by the Electrical Characteristics if operated under different conditions.

2. Applicable only to FPF2108. Latchoff current does not include current flowing into FLAGB.

TYPICAL CHARACTERISTICS

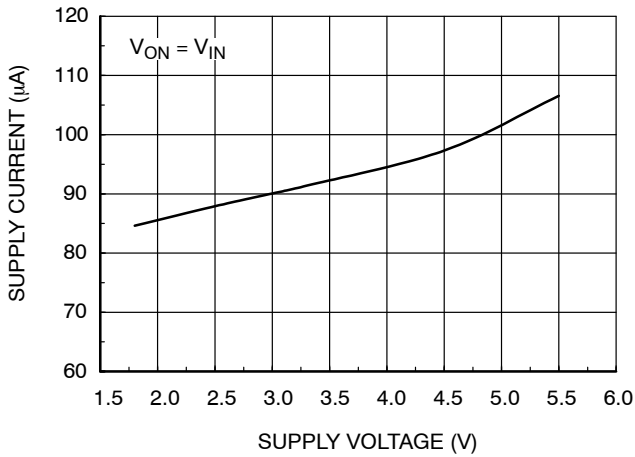

Figure 4. Quiescent Current vs. Input Voltage

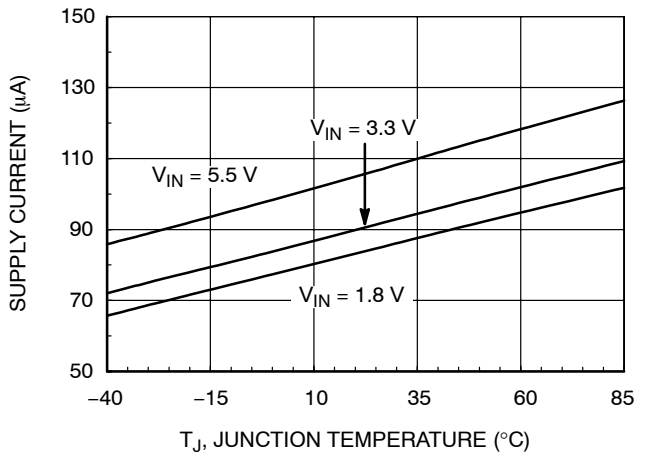

Figure 5. Quiescent Current vs. Temperature

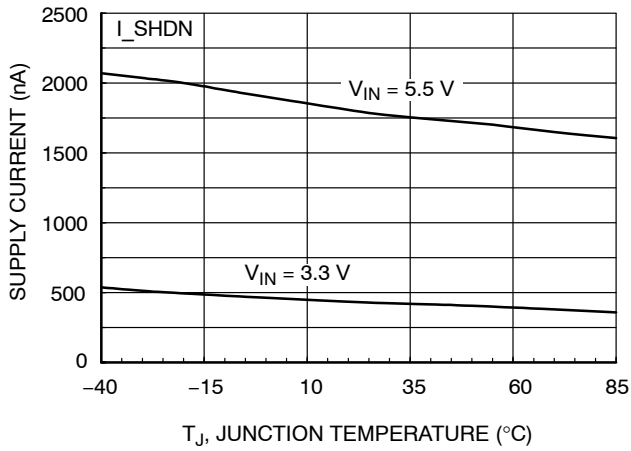

Figure 6. I_SHUTDOWN Current vs. Temperature

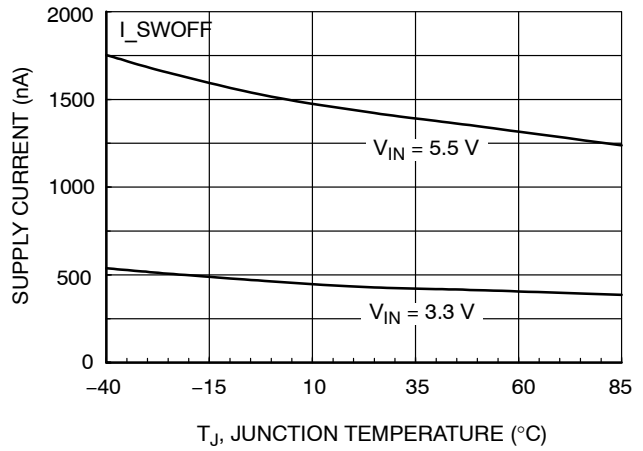

Figure 7. I_SWITCH-OFF Current vs. Temperature

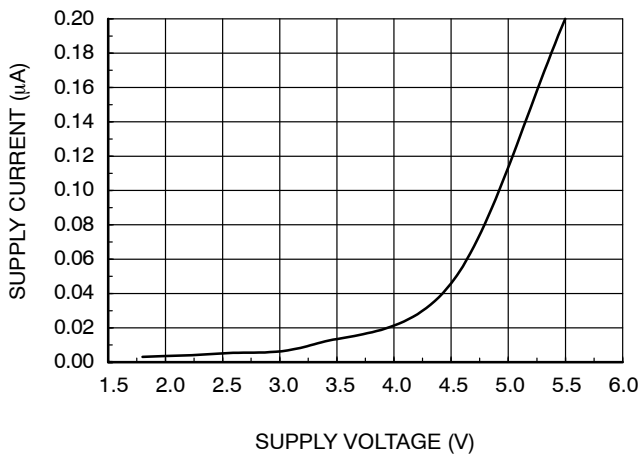

Figure 8. Reverse Current vs. V_OUT

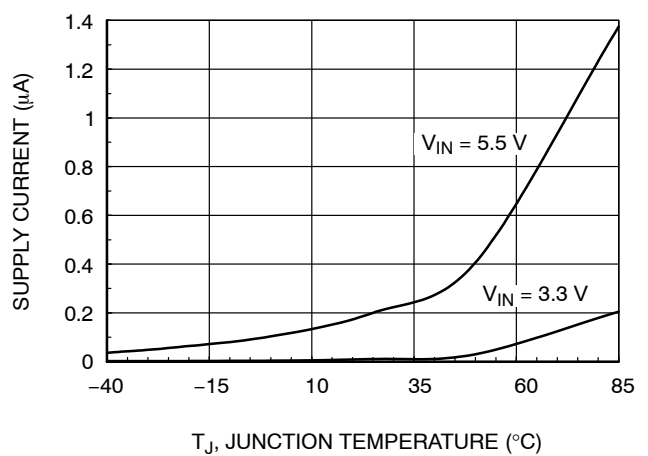

Figure 9. Reverse Current vs. Temperature

FPF2108 – FPF2110

TYPICAL CHARACTERISTICS (continued)

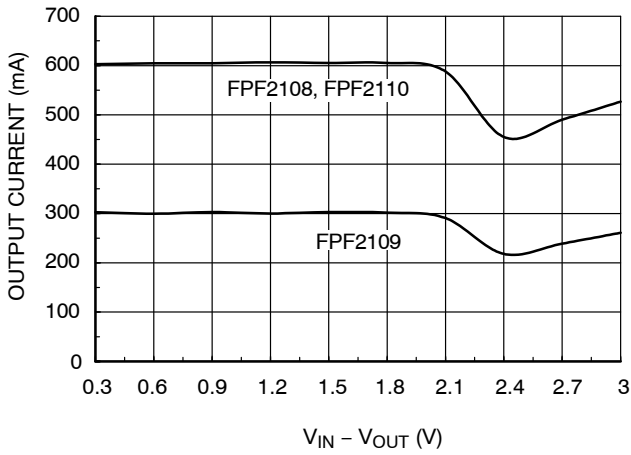

Figure 10. Current Limit vs. Output Voltage

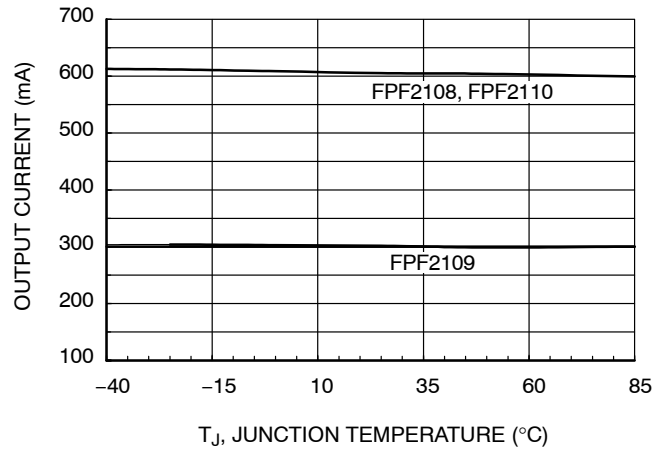

Figure 11. Current Limit vs. Temperature

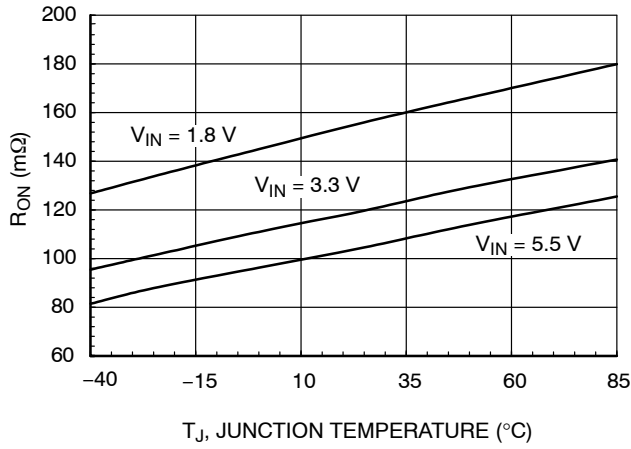

Figure 12. R_{ON} vs. Temperature

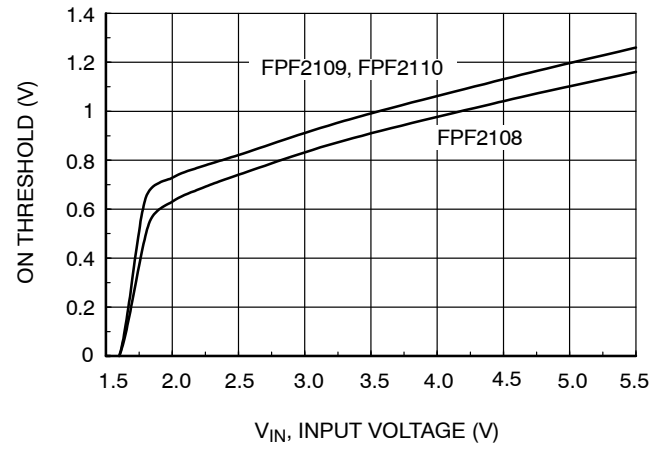

Figure 13. V_{IH} vs. V_{IN}

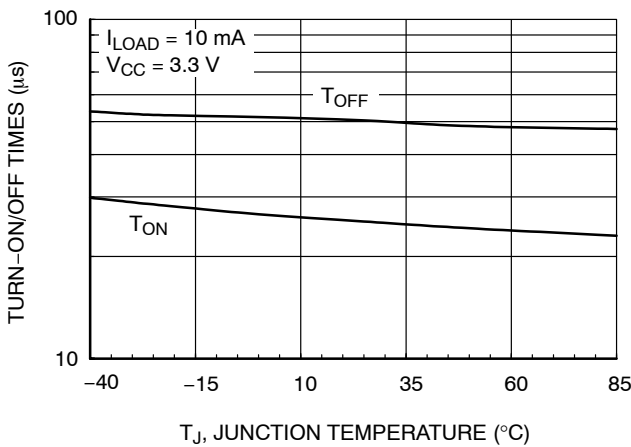

Figure 14. T_{ON}/T_{OFF} vs. Temperature

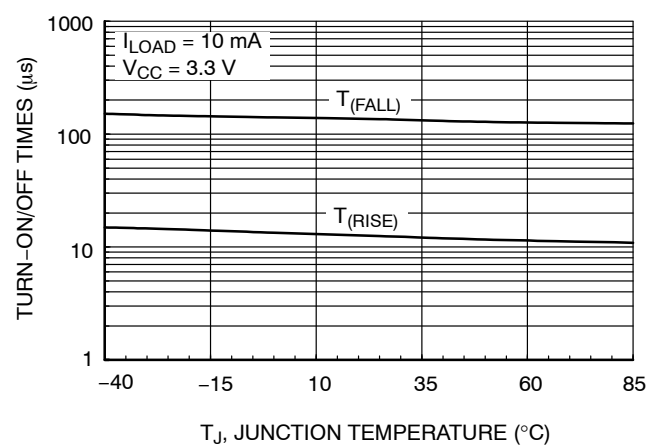

Figure 15. T_{RISE}/T_{FALL} vs. Temperature

TYPICAL CHARACTERISTICS (continued)

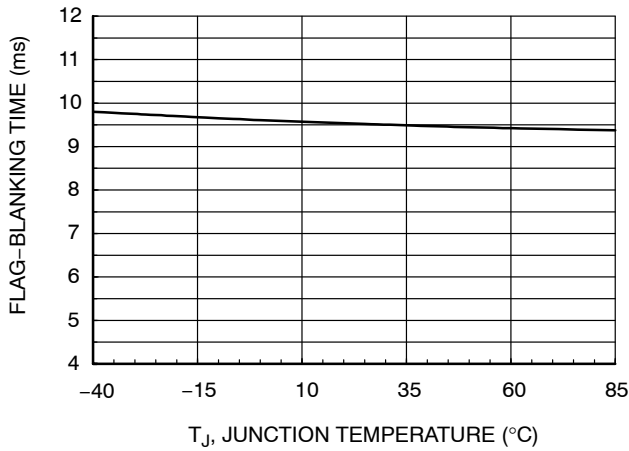

Figure 16. T_{BLANK} vs. Temperature

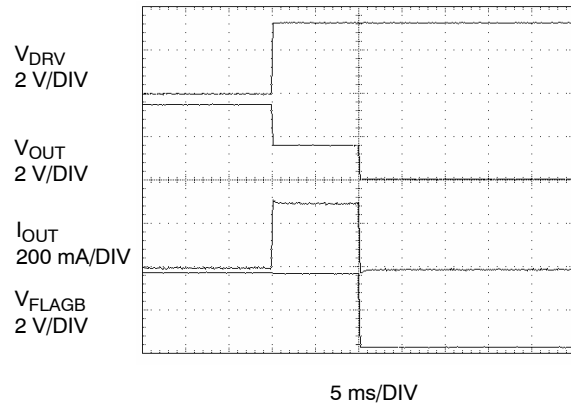

Figure 17. T_{BLANK} Response (V_{DRV} signal forces the device to go into overcurrent conditions.)

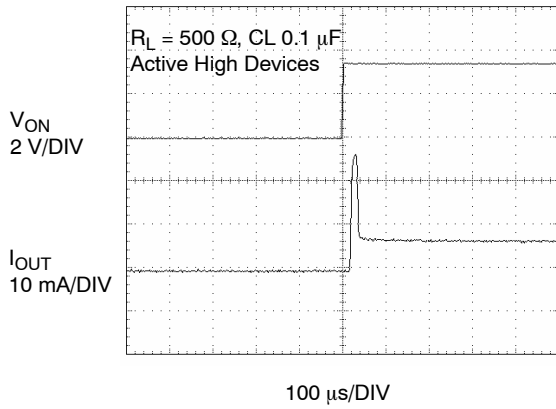

Figure 18. T_{ON} Response

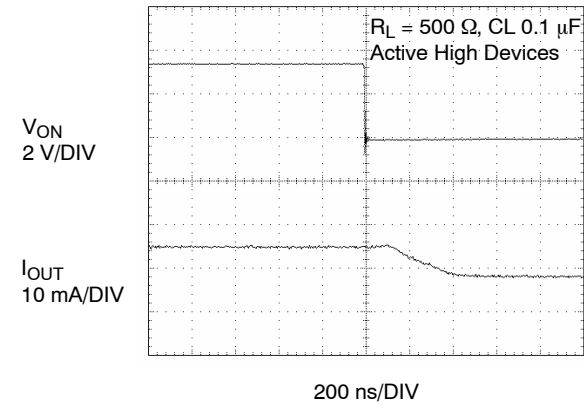

Figure 19. T_{OFF} Response

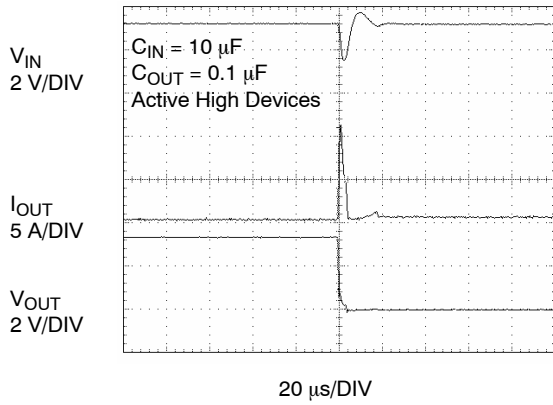

Figure 20. Short Circuit Response Time (Output Shorted to GND)

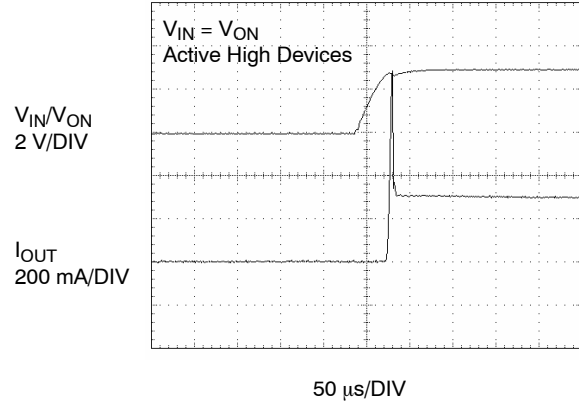

Figure 21. Current Limit Response (Switch power up to hard short.)

TYPICAL CHARACTERISTICS (continued)

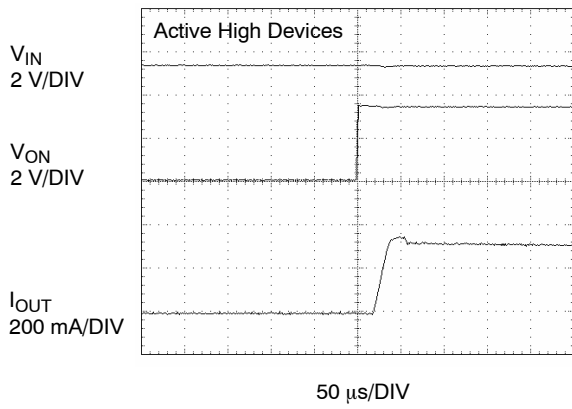

Figure 22. Current Limit Response Time
(Output Shorted to GND by 10 Ω , moderate short.)

DESCRIPTION OF OPERATION

The FPF2108–FPF2110 is a current limited switch that protects systems and loads which can be damaged or disrupted by the application of high currents. The core of the device is a 0.125 Ω P–channel MOSFET and a controller capable of functioning over a wide input operating range of 1.8 V–5.5 V. The controller protects against system malfunctions through current limiting, under–voltage lockout and thermal shutdown. The current limit is preset for either 200 mA or 400 mA.

On/Off Control

The ON pin controls the state of the switch. Active HI and LO versions are available. Refer to the Ordering Information for details. Activating ON continuously holds the switch in the on state so long as there is no fault. For all versions, an under–voltage on V_{IN} or a junction temperature in excess of 150°C overrides the ON control to turn off the switch. For FPF2108, the ON pin must be toggled to turn on the switch again. The FPF2109 and FPF2110 do not turn off in response to a over current condition but instead remain operating in a constant current mode so long as ON is active and the thermal shutdown or under–voltage lockout have not activated. When the MOSFET is off, the body diode is disabled so no current can flow through it.

Fault Reporting

Upon the detection of an over–current, an input under–voltage, or an over–temperature condition, the FLAGB signals the fault mode by activating LO. For the FPF2108, the FLAGB goes LO at the end of the blanking time while FLAGB goes LO immediately for the FPF2109 and FPF2110. For the FPF2108, FLAGB is latched LO and ON must be toggled to release it. With the FPF2109 and FPF2110, FLAGB is LO during the faults and immediately returns HI at the end of the fault condition. FLAGB is an open–drain MOSFET which requires a pull–up resistor between V_{IN} and FLAGB. During shutdown, the pull–down on FLAGB is disabled to reduce current draw from the supply.

Current Limiting

The current limit ensures that the current through the switch doesn't exceed a maximum value while not limiting at less than a minimum value. For the FPF2109 the minimum current is 200 mA and the maximum current is 400 mA and for the FPF2108 and FPF2110 the minimum current is 400 mA and the maximum current is 800 mA. The FPF2108 has a blanking time of 10 ms, nominally, during which the switch will act as a constant current source. At the end of the blanking time, the switch will be turned–off and the FLAGB pin will activate to indicate that current limiting has occurred. The FPF2109 and FPF2110 have no current limit blanking period so immediately upon a current limit condition FLAGB is activated. These parts will remain in a constant current state until the ON pin is deactivated or the thermal shutdown turns–off the switch.

Under–Voltage Lockout

The under–voltage lockout turns–off the switch if the input voltage drops below the under–voltage lockout threshold. With the ON pin active the input voltage rising above the under–voltage lockout threshold will cause a controlled turn on of the switch which limits current over–shoots.

Thermal Shutdown

The thermal shutdown protects the part from internally or externally generated excessive temperatures. During an over–temperature condition the FLAGB is activated and the switch is turned–off. The switch automatically turns–on again if the temperature of the die drops below the threshold temperature.

FPF2108 – FPF2110

APPLICATION INFORMATION

Typical Application

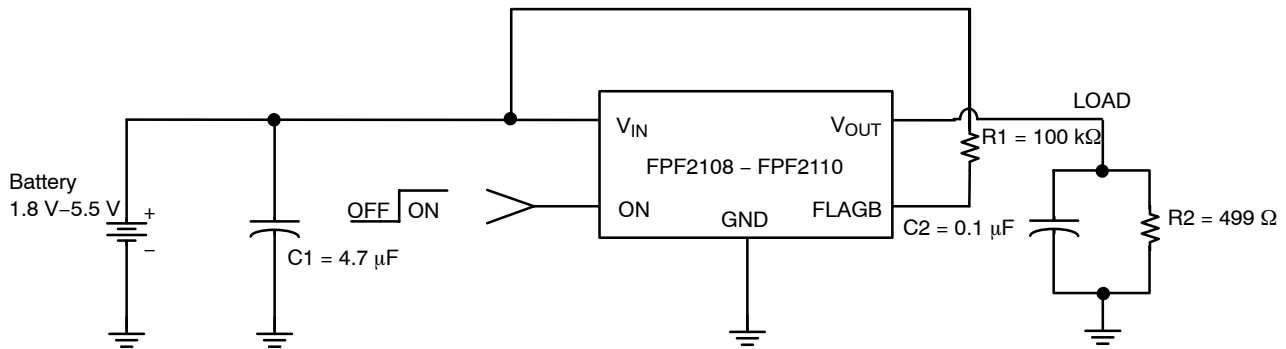

Figure 23. Typical Application

Input Capacitor

To limit the voltage drop on the input supply caused by transient in-rush currents when the switch turns-on into a discharged load capacitor or a short-circuit, a capacitor needs to be placed between V_{IN} and GND. A 4.7 μF ceramic capacitor, C_{IN} , must be placed close to the V_{IN} pin. A higher value of C_{IN} can be used to further reduce the voltage drop experienced as the switch is turned on into a large capacitive load.

Output Capacitor

A 0.1 μF capacitor C_{OUT} , should be placed between V_{OUT} and GND. This capacitor will prevent parasitic board inductances from forcing V_{OUT} below GND when the switch turns-off.

Power Dissipation

During normal operation as a switch, the power dissipation is small and has little effect on the operating temperature of the part. The parts with the higher current limits will dissipate the most power and that will only typically be, $P = (I_{LIM})^2 * R_{DS} = (0.8)^2 * 0.125 = 80 \text{ mW}$. When in current limit the maximum power dissipation will occur when the output is shorted to ground. A short on the output will cause the part to operate in a constant current state until the thermal shutdown activates. It will then cycle in and out of thermal shutdown so long as the ON pin is active and the short is present.

Board Layout

For best performance, all traces should be as short as possible. To be most effective, the input and output capacitors should be placed close to the device to minimize the effects that parasitic trace inductances may have on normal and short-circuit operation. Using wide traces for V_{IN} , V_{OUT} and GND will help minimize parasitic electrical effects along with minimizing the case to ambient thermal impedance.

FPF2108 – FPF2110

ORDERING INFORMATION

Part Number	Current Limit [mA]	Current Limit Blanking Time [ms]	Auto-Restart Time [ms]	ON Pin Activity	Top Mark	Shipping†
FPF2108	400	10	NA	Active LO	2108	3000 / Tape & Reel
FPF2109	200	0	NA	Active HI	2109	
FPF2110	400	0	NA	Active HI	2110	

†For information on tape and reel specifications, including part orientation and tape sizes, please refer to our Tape and Reel Packaging Specifications Brochure, [BRD8011/D](#).

IntelliMAX is a trademark of Semiconductor Components Industries, LLC dba "onsemi" or its affiliates and/or subsidiaries in the United States and/or other countries.

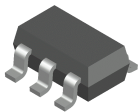

**SOT-23, 5 Lead
CASE 527AH
ISSUE A**

DATE 09 JUN 2021

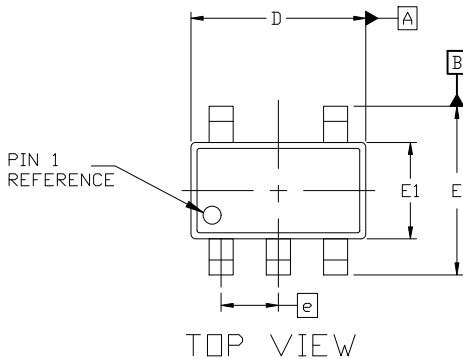

NOTES:

1. DIMENSIONING AND TOLERANCING PER ASME Y14.5M, 19894
2. CONTROLLING DIMENSION: MILLIMETERS
3. MAXIMUM LEAD THICKNESS INCLUDES LEAD FINISH THICKNESS. MINIMUM LEAD THICKNESS IS THE MINIMUM THICKNESS OF THE BASE MATERIAL.
4. DIMENSIONS D AND E1 DO NOT INCLUDE MOLD FLASH, PROTRUSIONS, OR GATE BURRS. MOLD FLASH, PROTRUSIONS, OR GATE BURRS SHALL NOT EXCEED 0.25 PER SIDE. D AND E1 DIMENSIONS ARE DETERMINED AT DATUM D.
5. DIMENSION 'b' DOES NOT INCLUDE DAMBAR PROTRUSION. ALLOWABLE DAMBAR PROTRUSION SHALL BE 0.08mm TOTAL IN EXCESS OF THE 'b' DIMENSION AT MAXIMUM MATERIAL CONDITION. MINIMUM SPACE BETWEEN PROTRUSION AND AN ADJACENT LEAD SHALL NOT BE LESS THAN 0.07mm.

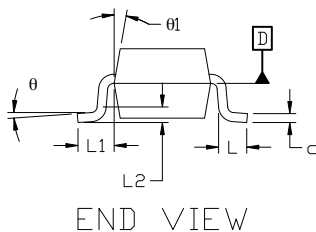
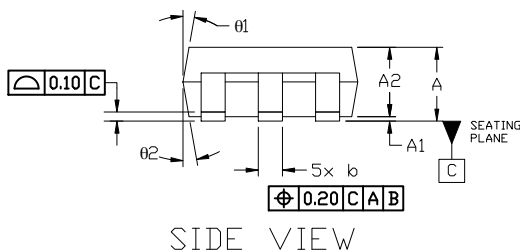

DIM	MILLIMETERS		
	MIN.	NOM.	MAX.
A	0.90	—	1.45
A1	0.00	—	0.15
A2	0.90	1.15	1.30
b	0.30	—	0.50
c	0.08	—	0.22
D	2.90 BSC		
E	2.80 BSC		
E1	1.60 BSC		
e	0.95 BSC		
L	0.30	0.45	0.60
L1	0.60 REF		
L2	0.25 REF		
theta	0°	4°	8°
theta1	0°	10°	15°
theta2	0°	10°	15°

GENERIC MARKING DIAGRAM*

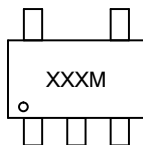

XXX = Specific Device Code
M = Date Code

*This information is generic. Please refer to device data sheet for actual part marking. Pb-Free indicator, "G" or microdot "•", may or may not be present. Some products may not follow the Generic Marking.

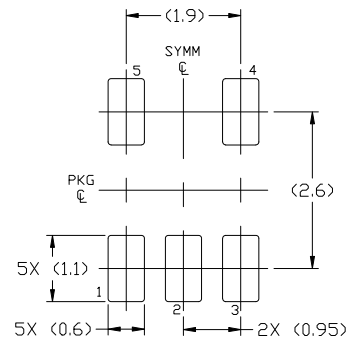

RECOMMENDED MOUNTING FOOTPRINT
For additional information on our Pb-Free strategy and soldering details, please download the DN Semiconductor Soldering and Mounting Techniques Reference Manual, SOLDERRM/D.

DOCUMENT NUMBER:	98AON34320E	Electronic versions are uncontrolled except when accessed directly from the Document Repository. Printed versions are uncontrolled except when stamped "CONTROLLED COPY" in red.
DESCRIPTION:	SOT-23, 5 LEAD	PAGE 1 OF 1

onsemi and ONSEMI are trademarks of Semiconductor Components Industries, LLC dba onsemi or its subsidiaries in the United States and/or other countries. onsemi reserves the right to make changes without further notice to any products herein. onsemi makes no warranty, representation or guarantee regarding the suitability of its products for any particular purpose, nor does onsemi assume any liability arising out of the application or use of any product or circuit, and specifically disclaims any and all liability, including without limitation special, consequential or incidental damages. onsemi does not convey any license under its patent rights nor the rights of others.

onsemi, **Onsemi**, and other names, marks, and brands are registered and/or common law trademarks of Semiconductor Components Industries, LLC dba "**onsemi**" or its affiliates and/or subsidiaries in the United States and/or other countries. **onsemi** owns the rights to a number of patents, trademarks, copyrights, trade secrets, and other intellectual property. A listing of **onsemi**'s product/patent coverage may be accessed at www.onsemi.com/site/pdf/Patent-Marking.pdf. **onsemi** reserves the right to make changes at any time to any products or information herein, without notice. The information herein is provided "as-is" and **onsemi** makes no warranty, representation or guarantee regarding the accuracy of the information, product features, availability, functionality, or suitability of its products for any particular purpose, nor does **onsemi** assume any liability arising out of the application or use of any product or circuit, and specifically disclaims any and all liability, including without limitation special, consequential or incidental damages. Buyer is responsible for its products and applications using **onsemi** products, including compliance with all laws, regulations and safety requirements or standards, regardless of any support or applications information provided by **onsemi**. "Typical" parameters which may be provided in **onsemi** data sheets and/or specifications can and do vary in different applications and actual performance may vary over time. All operating parameters, including "Typicals" must be validated for each customer application by customer's technical experts. **onsemi** does not convey any license under any of its intellectual property rights nor the rights of others. **onsemi** products are not designed, intended, or authorized for use as a critical component in life support systems or any FDA Class 3 medical devices or medical devices with a same or similar classification in a foreign jurisdiction or any devices intended for implantation in the human body. Should Buyer purchase or use **onsemi** products for any such unintended or unauthorized application, Buyer shall indemnify and hold **onsemi** and its officers, employees, subsidiaries, affiliates, and distributors harmless against all claims, costs, damages, and expenses, and reasonable attorney fees arising out of, directly or indirectly, any claim of personal injury or death associated with such unintended or unauthorized use, even if such claim alleges that **onsemi** was negligent regarding the design or manufacture of the part. **onsemi** is an Equal Opportunity/Affirmative Action Employer. This literature is subject to all applicable copyright laws and is not for resale in any manner.

ADDITIONAL INFORMATION

TECHNICAL PUBLICATIONS:

Technical Library: www.onsemi.com/design/resources/technical-documentation
onsemi Website: www.onsemi.com

ONLINE SUPPORT: www.onsemi.com/support

For additional information, please contact your local Sales Representative at www.onsemi.com/support/sales