

3.3 V LVDS, 2-Bit, High-Speed, Differential Driver

FIN1027A

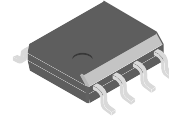

SOIC8
 CASE 751EB

General Description

This dual driver is designed for high-speed interconnects utilizing Low Voltage Differential Signaling (LVDS) technology. The driver translates LVTTTL signal levels to LVDS levels with a typical differential output swing of 350 mV, which provides low EMI at ultra-low power dissipation, even at high frequencies. This device is ideal for high-speed transfer of clock or data.

The FIN1027A can be paired with its companion receiver, the FIN1028, or with any other LVDS receiver

Features

- Greater than 600 Mbs Data Rate
- 3 V Power Supply Operation
- 5 ns Maximum Differential Pulse Skew
- 1.5 ns Maximum Propagation Delay
- Low Power Dissipation
- Power-Off Protection
- Meets or Exceeds the TIA/EIA-644 LVDS Standard
- Flow-through Pinout Simplifies PCB Layout
- This Device is Pb-Free, Halide Free and is RoHS Compliant

PIN CONFIGURATION

Name	Pin#	Description
V _{CC}	1	Power Supply
D _{IN1}	2	LVTTTL Data Input
D _{IN2}	3	LVTTTL Data Input
GND	4	Ground
D _{OUT2-}	5	Inverting Driver Output
D _{OUT2+}	6	Non-Inverting Driver Output
D _{OUT1+}	8	Non-Inverting Driver Output
D _{OUT1-}	7	Inverting Driver Output

FUNCTIONAL TABLE

Input	Outputs	
	D _{OUT+}	D _{OUT-}
LOW	LOW	HIGH
HIGH	HIGH	LOW
OPEN	LOW	HIGH

MARKING DIAGRAM

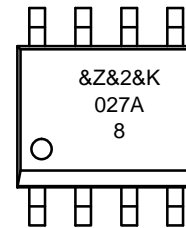

- &Z = Assembly Plant Code
- &2 = 2-Digit Date Code
- &K = 2-Digits Lot Run Traceability Code
- 027A8 = Specific Device Code

PIN CONFIGURATION

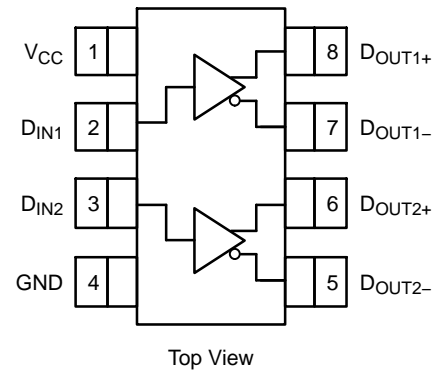

ORDERING INFORMATION

See detailed ordering and shipping information on page 7 of this data sheet.

FIN1027A

ABSOLUTE MAXIMUM RATINGS

Symbol	Parameter	Min	Max	Unit
V _{CC}	Supply Voltage	-0.5	4.6	V
D _{IN}	DC Input Voltage	-0.5	6.0	V
D _{OUT}	DC Output Voltage	-0.5	4.7	V
I _{OSD}	Driver Short-Circuit Current	Continuous		mA
T _{STG}	Storage Temperature Range	-65	+150	°C
T _J	Maximum Junction Temperature	-	+150	°C
T _L	Lead Temperature, Soldering, 10 Seconds	-	+260	°C
ESD	Human Body Model, JESD22-A114	-	≥6500	V
	Machine Model, JESD22-A115	-	≥400	

Stresses exceeding those listed in the Maximum Ratings table may damage the device. If any of these limits are exceeded, device functionality should not be assumed, damage may occur and reliability may be affected.

RECOMMENDED OPERATING CONDITIONS

Symbol	Parameter	Min	Max	Unit
V _{CC}	Supply Voltage	3.0	3.6	V
V _{IN}	Input Voltage	0	V _{CC}	V
T _A	Operating Temperature	-40	+85	°C

Functional operation above the stresses listed in the Recommended Operating Ranges is not implied. Extended exposure to stresses beyond the Recommended Operating Ranges limits may affect device reliability.

DC ELECTRICAL CHARACTERISTICS (All typical values are at T_A = 25°C and with V_{CC} = 3.3 V. Over-supply voltage and operating temperature ranges, unless otherwise specified.)

Symbol	Parameter	Conditions	Min	Typ	Max	Unit
V _{OD}	Output Differential Voltage	R _L = 100 Ω, See Figure 1	250	350	450	mV
ΔV _{OD}	VOD Magnitude Change from Differential LOW-to-HIGH		-	-	25	mV
V _{OS}	Offset Voltage		1.125	1.250	1.375	V
ΔV _{OS}	Offset Magnitude Change from Differential LOW-to-HIGH		-	-	25	mV
I _{OFF}	Power-Off Output Current	V _{CC} = 0 V, V _{OUT} = 0 V or 3.6 V	-	-	±20	μA
I _{OS}	Short-Circuit Output Current	V _{OUT} = 0 V	-	-	-8	mA
		V _{OD} = 0 V	-	-	±8	
V _{IH}	Input HIGH Voltage		2.0	-	V _{CC}	V
V _{IL}	Input LOW Voltage		GND	-	0.8	V
I _{IN}	Input Current	V _{IN} = 0 V or V _{CC}	-	-	±20	μA
I _{I(OFF)}	Power-Off Input Current	V _{CC} = 0 V, V _{IN} = 0 V or 3.6 V	-	-	±20	μA
V _{IK}	Input Clamp Voltage	I _{IK} = -18 mA	-1.5	-	-	V
I _{CC}	Power Supply Current	No Load, V _{IN} = 0 V or V _{CC}	-	-	12.5	mA
		R _L = 100 Ω, V _{IN} = 0 V or V _{CC}	-	-	17.0	
C _{IN}	Input Capacitance		-	4	-	pF
C _{OUT}	Output Capacitance		-	6	-	pF

FIN1027A

AC ELECTRICAL CHARACTERISTICS (All typical values are at $T_A = 25^\circ\text{C}$ and with $V_{CC} = 3.3\text{ V}$. Over-supply voltage and operating temperature ranges, unless otherwise specified.)

Symbol	Parameter	Test Condition	Min	Typ	Max	Unit
t_{PLHD}	Differential Propagation Delay, LOW-to-HIGH	$R_L = 100\ \Omega$, $C_L = 10\ \text{pF}$, see Figure 2 and Figure 3	0.5	–	1.5	ns
t_{PHLD}	Differential Propagation Delay, HIGH-to-LOW		0.5	–	1.5	ns
t_{TLHD}	Differential Output Rise Time (20% to 80%)		0.4	–	1.0	ns
t_{THLD}	Differential Output Fall Time (80% to 20%)		0.4	–	1.0	ns
$t_{SK(P)}$	Pulse Skew $ t_{PLH} - t_{PHL} $		–	–	0.5	ns
$t_{SK(LH)}$, $t_{SK(HL)}$	Channel-to-Channel Skew (Note 1)		–	–	0.3	ns
$t_{SK(PP)}$	Part-to-Part Skew (Note 2)		–	–	1.0	ns

- $t_{SK(LH)}$, $t_{SK(HL)}$ is the skew between specified outputs of a single device when the outputs have identical loads and are switching in the same direction.
- $t_{SK(PP)}$ is the magnitude of the difference in propagation delay times between any specified terminals of two devices switching in the same direction (either LOW-to-HIGH or HIGH-to-LOW) when both devices operate with the same supply voltage, same temperature, and have identical test circuits.

TEST DIAGRAMS

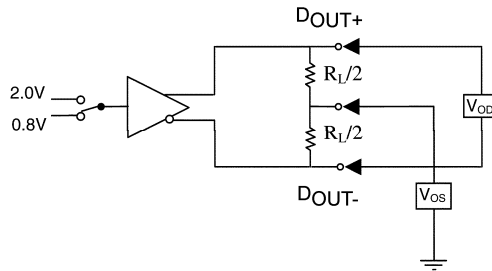
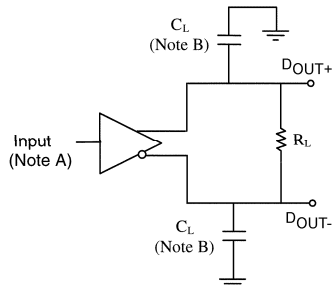

Figure 1. Differential Driver DC Test Circuit



NOTES:

- All input pulses have frequency = 10 MHz, t_R or $t_F = 2\text{ ns}$.
- C_L includes all probe and fixture capacitances.

Figure 2. Differential Driver Propagation Delay and Transition Time Test Circuit

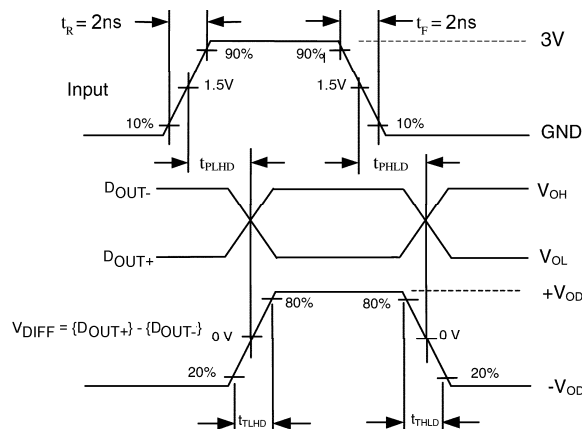

Figure 3. AC Waveforms

TYPICAL PERFORMANCE CHARACTERISTICS

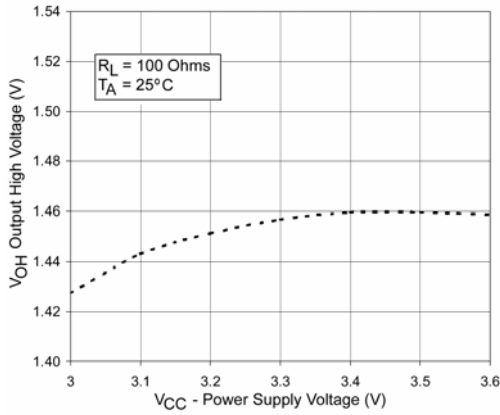

Figure 4. Output High Voltage vs. Power Supply Voltage

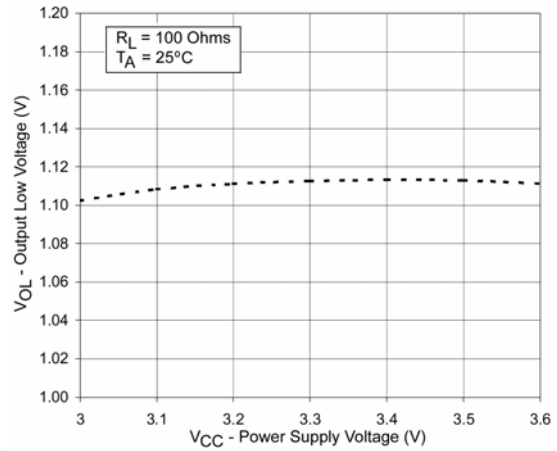

Figure 5. Output Low Voltage vs. Power Supply Voltage

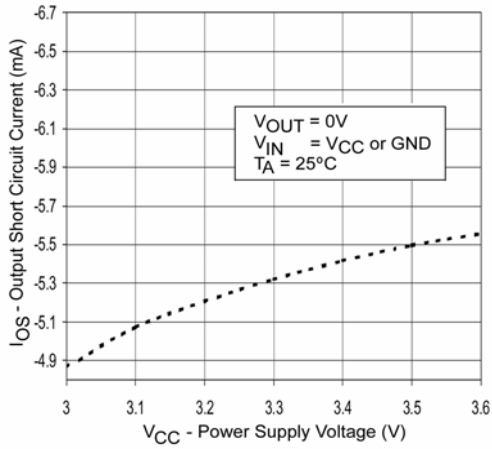

Figure 6. Output Short Circuit Current vs. Power Supply Voltage

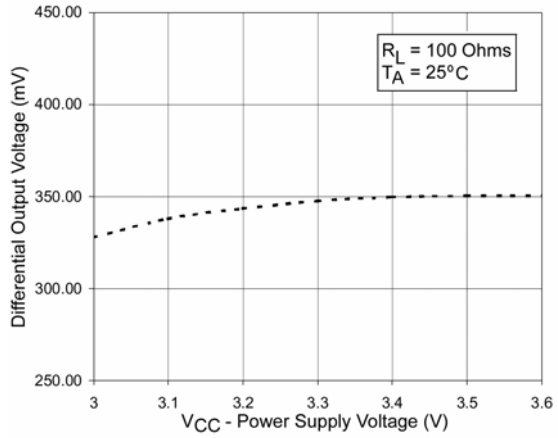

Figure 7. Differential Output Voltage vs. Power Supply Voltage

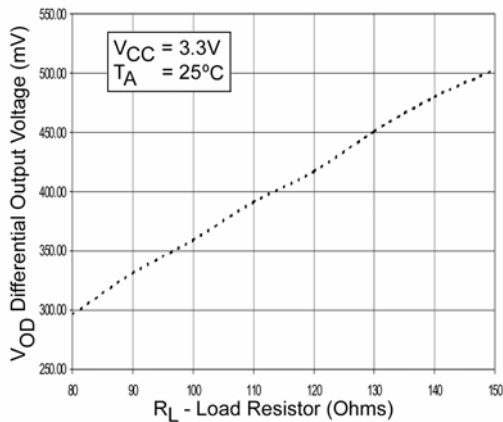

Figure 8. Differential Output Voltage vs. Load Resistor

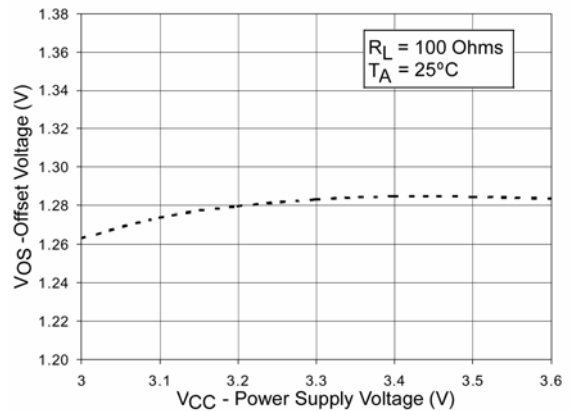

Figure 9. Offset Voltage vs. Power Supply Voltage

TYPICAL PERFORMANCE CHARACTERISTICS (CONTINUED)

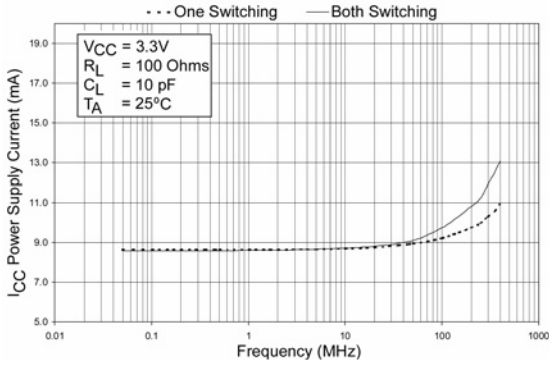

Figure 10. Power Supply Current vs. Frequency

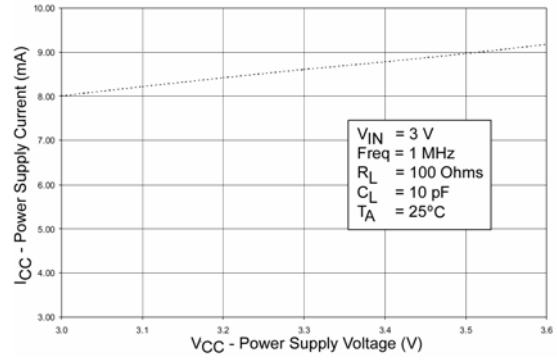

Figure 11. Power Supply Current vs. Power Supply Voltage

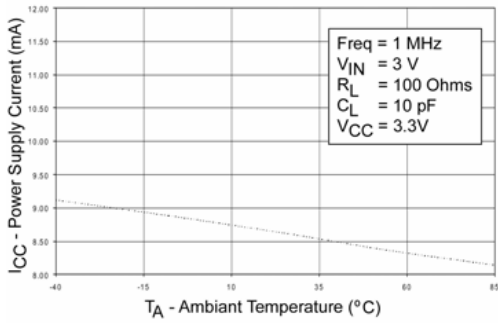

Figure 12. Power Supply Current vs. Ambient Temperature

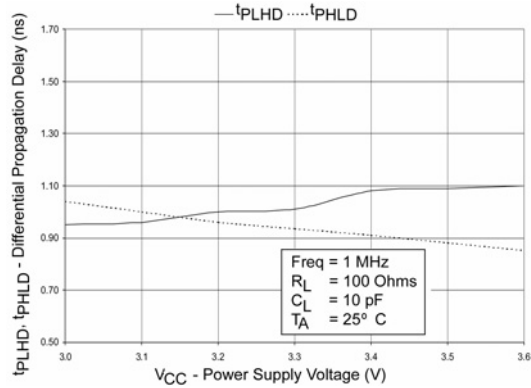

Figure 13. Differential Propagation Delay vs. Power Supply

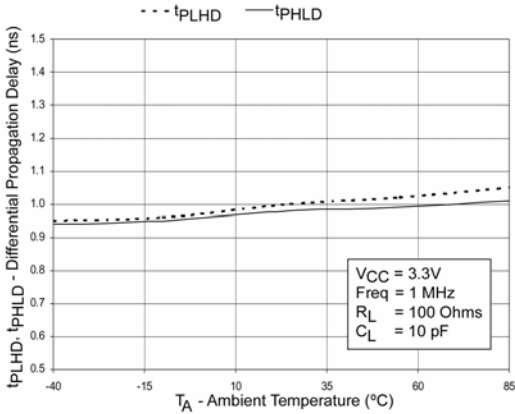

Figure 14. Differential Propagation Delay vs. Ambient Temperature

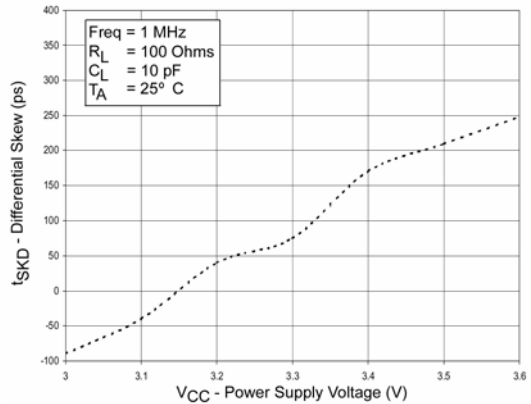

Figure 15. Differential Skew ($t_{PLH} - t_{PHL}$) vs. Power Supply

TYPICAL PERFORMANCE CHARACTERISTICS (CONTINUED)

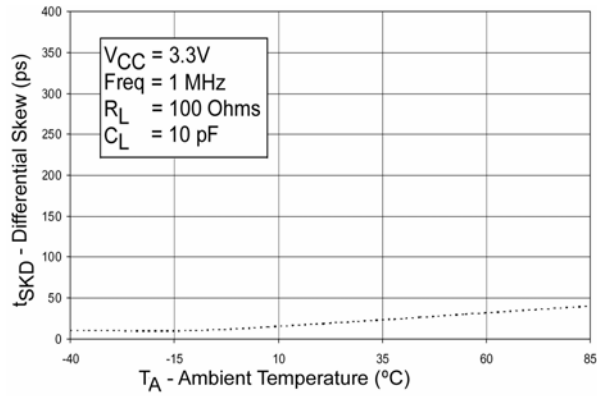

Figure 16. Differential Pulse Skew ($t_{PLH} - t_{PHL}$)

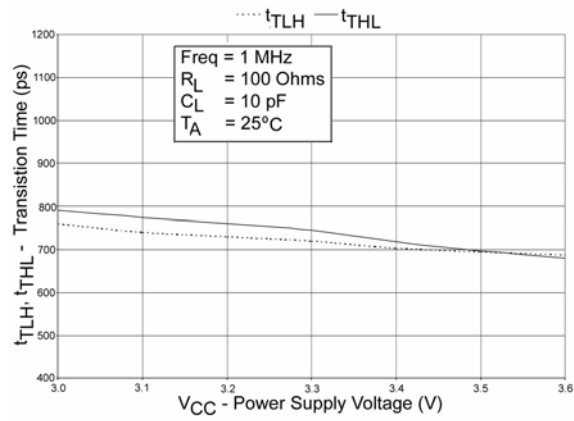

Figure 17. Transition Time vs. Power Supply Voltage

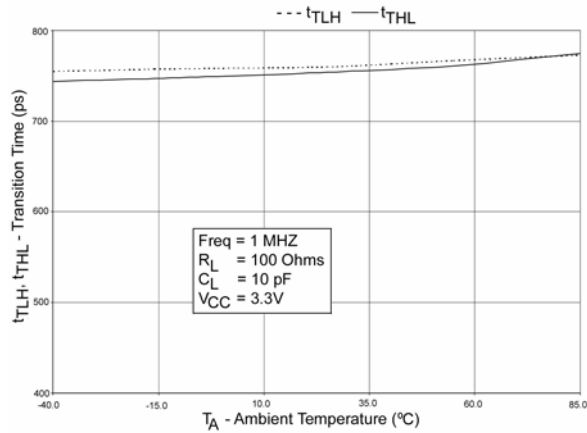

Figure 18. Transition Time vs. Ambient Temperature

FIN1027A

ORDERING INFORMATION

Part Number	Operating Range Temperature	Package	Shipping†
FIN1027AMX	-40 to +85°C	8-Lead Small Outline Package (SOIC), JEDEC MS-012, 0.150 inch Narrow (Pb-Free, Halide Free)	2500 / Tape & Reel

†For information on tape and reel specifications, including part orientation and tape sizes, please refer to our Tape and Reel Packaging Specifications Brochure, BRD8011/D.

SOIC8
CASE 751EB
ISSUE A

DATE 24 AUG 2017

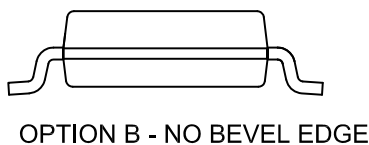
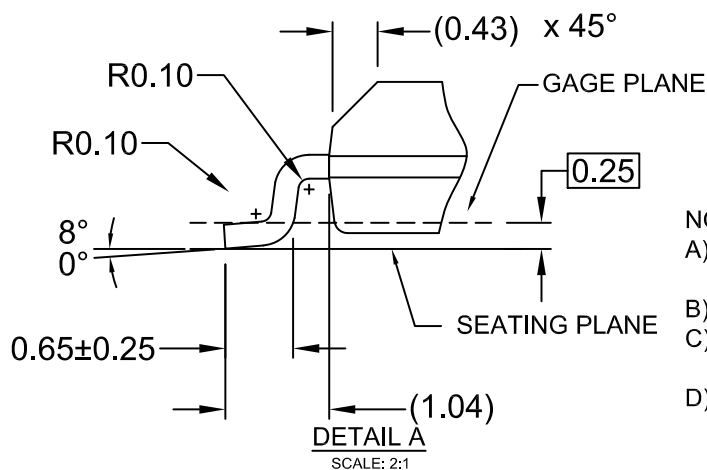
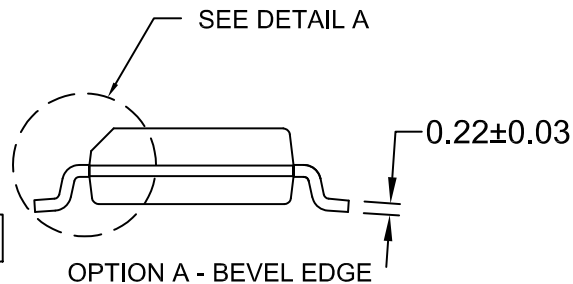
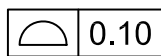
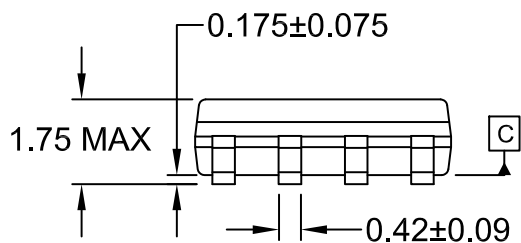
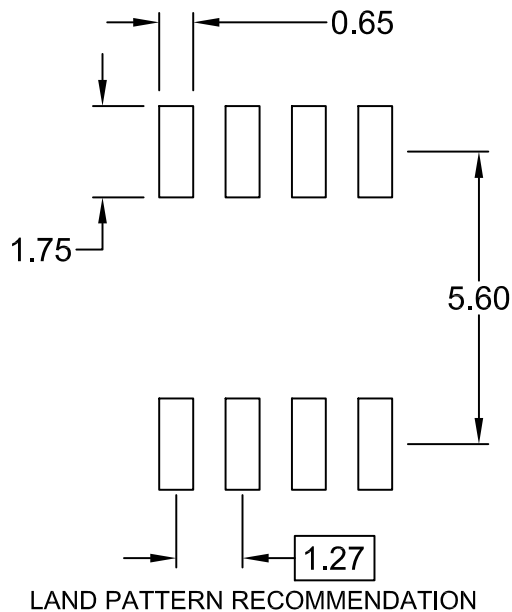
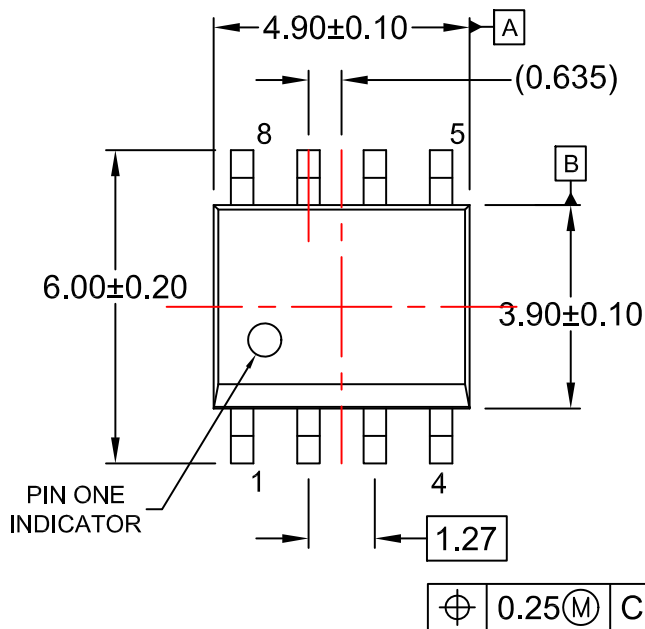

- NOTES:
- A) THIS PACKAGE CONFORMS TO JEDEC MS-012, VARIATION AA.
 - B) ALL DIMENSIONS ARE IN MILLIMETERS.
 - C) DIMENSIONS DO NOT INCLUDE MOLD FLASH OR BURRS.
 - D) LANDPATTERN STANDARD: SOIC127P600X175-8M

DOCUMENT NUMBER:	98AON13735G	Electronic versions are uncontrolled except when accessed directly from the Document Repository. Printed versions are uncontrolled except when stamped "CONTROLLED COPY" in red.
DESCRIPTION:	SOIC8	PAGE 1 OF 1

onsemi and ONSEMI are trademarks of Semiconductor Components Industries, LLC dba onsemi or its subsidiaries in the United States and/or other countries. onsemi reserves the right to make changes without further notice to any products herein. onsemi makes no warranty, representation or guarantee regarding the suitability of its products for any particular purpose, nor does onsemi assume any liability arising out of the application or use of any product or circuit, and specifically disclaims any and all liability, including without limitation special, consequential or incidental damages. onsemi does not convey any license under its patent rights nor the rights of others.

onsemi, **Onsemi**, and other names, marks, and brands are registered and/or common law trademarks of Semiconductor Components Industries, LLC dba "**onsemi**" or its affiliates and/or subsidiaries in the United States and/or other countries. **onsemi** owns the rights to a number of patents, trademarks, copyrights, trade secrets, and other intellectual property. A listing of **onsemi**'s product/patent coverage may be accessed at www.onsemi.com/site/pdf/Patent-Marking.pdf. **onsemi** reserves the right to make changes at any time to any products or information herein, without notice. The information herein is provided "as-is" and **onsemi** makes no warranty, representation or guarantee regarding the accuracy of the information, product features, availability, functionality, or suitability of its products for any particular purpose, nor does **onsemi** assume any liability arising out of the application or use of any product or circuit, and specifically disclaims any and all liability, including without limitation special, consequential or incidental damages. Buyer is responsible for its products and applications using **onsemi** products, including compliance with all laws, regulations and safety requirements or standards, regardless of any support or applications information provided by **onsemi**. "Typical" parameters which may be provided in **onsemi** data sheets and/or specifications can and do vary in different applications and actual performance may vary over time. All operating parameters, including "Typicals" must be validated for each customer application by customer's technical experts. **onsemi** does not convey any license under any of its intellectual property rights nor the rights of others. **onsemi** products are not designed, intended, or authorized for use as a critical component in life support systems or any FDA Class 3 medical devices or medical devices with a same or similar classification in a foreign jurisdiction or any devices intended for implantation in the human body. Should Buyer purchase or use **onsemi** products for any such unintended or unauthorized application, Buyer shall indemnify and hold **onsemi** and its officers, employees, subsidiaries, affiliates, and distributors harmless against all claims, costs, damages, and expenses, and reasonable attorney fees arising out of, directly or indirectly, any claim of personal injury or death associated with such unintended or unauthorized use, even if such claim alleges that **onsemi** was negligent regarding the design or manufacture of the part. **onsemi** is an Equal Opportunity/Affirmative Action Employer. This literature is subject to all applicable copyright laws and is not for resale in any manner.

ADDITIONAL INFORMATION

TECHNICAL PUBLICATIONS:

Technical Library: www.onsemi.com/design/resources/technical-documentation
onsemi Website: www.onsemi.com

ONLINE SUPPORT: www.onsemi.com/support

For additional information, please contact your local Sales Representative at www.onsemi.com/support/sales

