

# FGD3040G2-F085C FGB3040G2-F085C

## EcoSPARK<sup>®</sup> 2 Ignition IGBT 300 mJ, 400 V, N-Channel Ignition IGBT

### Features

- SCIS Energy = 300 mJ at  $T_J = 25^\circ\text{C}$
- Logic Level Gate Drive
- AEC-Q101 Qualified and PPAP Capable
- These Devices are Pb-Free and are RoHS Compliant

### Applications

- Automotive Ignition Coil Driver Circuits
- High Current Ignition System
- Coil on Plug Application

### MAXIMUM RATINGS ( $T_J = 25^\circ\text{C}$ unless otherwise noted)

Symbol	Parameter	Value	Unit
$BV_{CER}$	Collector to Emitter Breakdown Voltage ( $I_C = 1\text{ mA}$ )	400	V
$BV_{ECS}$	Emitter to Collector Voltage – Reverse Battery Condition ( $I_C = 10\text{ mA}$ )	28	V
$E_{SCIS25}$	ISCIS = 14.2 A, L = 3.0 mHy, RGE = 1 K $\Omega$ , $T_C = 25^\circ\text{C}$ (Note 1)	300	mJ
$E_{SCIS150}$	ISCIS = 10.8 A, L = 3.0 mHy, RGE = 1 K $\Omega$ , $T_C = 150^\circ\text{C}$ (Note 2)	170	mJ
IC25	Collector Current Continuous at $V_{GE} = 5.0\text{ V}$ , $T_C = 25^\circ\text{C}$	41	A
IC110	Collector Current Continuous at $V_{GE} = 5.0\text{ V}$ , $T_C = 110^\circ\text{C}$	25.6	A
$V_{GEM}$	Gate to Emitter Voltage Continuous	$\pm 10$	V
PD	Power Dissipation Total, $T_C = 25^\circ\text{C}$	150	W
	Power Dissipation Derating, $T_C > 25^\circ\text{C}$	1	W/ $^\circ\text{C}$
$T_J, T_{STG}$	Operating Junction and Storage Temperature	-55 to +175	$^\circ\text{C}$
$T_L$	Lead Temperature for Soldering Purposes (1/8" from case for 10 s)	300	$^\circ\text{C}$
$T_{PKG}$	Reflow Soldering according to JESD020C	260	$^\circ\text{C}$
ESD	HBM–Electrostatic Discharge Voltage at 100 pF, 1500 $\Omega$	4	kV
	CDM–Electrostatic Discharge Voltage at 1 $\Omega$	2	kV

Stresses exceeding those listed in the Maximum Ratings table may damage the device. If any of these limits are exceeded, device functionality should not be assumed, damage may occur and reliability may be affected.

1. Self clamped inductive Switching Energy ( $E_{SCIS25}$ ) of 300 mJ is based on the test conditions that is starting  $T_J = 25^\circ\text{C}$ , L = 3 mHy, ISCIS = 14.2 A, VCC = 100 V during inductor charging and VCC = 0 V during time in clamp.
2. Self Clamped inductive Switching Energy ( $E_{SCIS150}$ ) of 170 mJ is based on the test conditions that is starting  $T_J = 150^\circ\text{C}$ , L = 3mHy, ISCIS = 10.8 A, VCC = 100 V during inductor charging and VCC = 0 V during time in clamp.



ON Semiconductor<sup>®</sup>

[www.onsemi.com](http://www.onsemi.com)

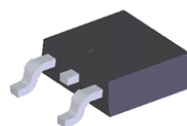
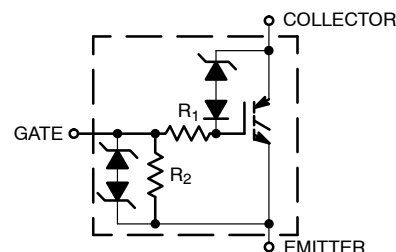

DPAK3  
CASE 369AS

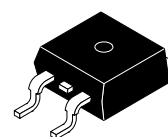

D<sup>2</sup>PAK-3  
CASE 418AJ

### MARKING DIAGRAM

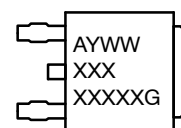

- A = Assembly Location
- Y = Year
- WW = Work Week
- XXXX = Device Code
- G = Pb-Free Package

### ORDERING INFORMATION

See detailed ordering and shipping information on page 2 of this data sheet.

# FGD3040G2-F085C

## THERMAL RESISTANCE RATINGS

Characteristic	Symbol	Max	Units
Junction-to-Case – Steady State (Drain)	$R_{\theta JC}$	1	°C/W

## ELECTRICAL CHARACTERISTICS ( $T_J = 25^\circ\text{C}$ unless otherwise specified)

Symbol	Parameter	Test Conditions	Min	Typ.	Max.	Units
--------	-----------	-----------------	-----	------	------	-------

### OFF CHARACTERISTICS

$BV_{CER}$	Collector to Emitter Breakdown Voltage	$I_{CE} = 2\text{ mA}$ , $V_{GE} = 0\text{ V}$ , $R_{GE} = 1\text{ k}\Omega$ , $T_J = -40\text{ to }150^\circ\text{C}$	370	400	430	V	
$BV_{CES}$	Collector to Emitter Breakdown Voltage	$I_{CE} = 10\text{ mA}$ , $V_{GE} = 0\text{ V}$ , $R_{GE} = 0$ , $T_J = -40\text{ to }150^\circ\text{C}$	390	420	450	V	
$BV_{ECS}$	Emitter to Collector Breakdown Voltage	$I_{CE} = -75\text{ mA}$ , $V_{GE} = 0\text{ V}$ , $T_J = 25^\circ\text{C}$	28	-	-	V	
$BV_{GES}$	Gate to Emitter Breakdown Voltage	$I_{GES} = \pm 2\text{ mA}$	$\pm 12$	$\pm 14$	-	V	
$I_{CER}$	Collector to Emitter Leakage Current	$V_{CE} = 175\text{ V}$ $R_{GE} = 1\text{ k}\Omega$	$T_J = 25^\circ\text{C}$	-	-	25	$\mu\text{A}$
			$T_J = 150^\circ\text{C}$	-	-	1	mA
$I_{ECS}$	Emitter to Collector Leakage Current	$V_{EC} = 24\text{ V}$	$T_J = 25^\circ\text{C}$	-	-	1	mA
			$T_J = 150^\circ\text{C}$	-	-	40	
$R_1$	Series Gate Resistance		-	120	-	$\Omega$	
$R_2$	Gate to Emitter Resistance		10K	-	30K	$\Omega$	

### ON CHARACTERISTICS

$V_{CE(SAT)}$	Collector to Emitter Saturation Voltage	$I_{CE} = 6\text{ A}$ , $V_{GE} = 4\text{ V}$ , $T_J = 25^\circ\text{C}$	-	1.15	1.25	V
$V_{CE(SAT)}$	Collector to Emitter Saturation Voltage	$I_{CE} = 10\text{ A}$ , $V_{GE} = 4.5\text{ V}$ , $T_J = 150^\circ\text{C}$	-	1.35	1.50	V
$V_{CE(SAT)}$	Collector to Emitter Saturation Voltage	$I_{CE} = 15\text{ A}$ , $V_{GE} = 5\text{ V}$ , $T_J = 150^\circ\text{C}$	-	1.68	1.85	V

### DYNAMIC CHARACTERISTICS

$Q_{G(ON)}$	Gate Charge	$I_{CE} = 10\text{ A}$ , $V_{CE} = 12\text{ V}$ , $V_{GE} = 5\text{ V}$	-	21	-	nC	
$V_{GE(TH)}$	Gate to Emitter Threshold Voltage	$I_{CE} = 1\text{ mA}$ $V_{CE} = V_{GE}$	$T_J = 25^\circ\text{C}$	1.3	1.5	2.2	V
			$T_J = 150^\circ\text{C}$	0.75	1.2	1.8	
$V_{GEP}$	Gate to Emitter Plateau Voltage	$V_{CE} = 12\text{ V}$ , $I_{CE} = 10\text{ A}$	-	2.8	-	V	

### SWITCHING CHARACTERISTICS

$t_{d(ON)R}$	Current Turn-On Delay Time-Resistive	$V_{CE} = 14\text{ V}$ , $R_L = 1\text{ }\Omega$ , $V_{GE} = 5\text{ V}$ , $R_G = 470\text{ }\Omega$ , $T_J = 25^\circ\text{C}$	-	0.9	4	$\mu\text{s}$
$t_{rR}$	Current Rise Time-Resistive		-	1.9	7	
$t_{d(OFF)L}$	Current Turn-Off Delay Time-Inductive	$V_{CE} = 300\text{ V}$ , $L = 1\text{ mH}$ , $V_{GE} = 5\text{ V}$ , $R_G = 470\text{ }\Omega$ , $I_{CE} = 6.5\text{ A}$ , $T_J = 25^\circ\text{C}$	-	4.8	10	
$t_{fL}$	Current Fall Time-Inductive		-	2.0	15	

Product parametric performance is indicated in the Electrical Characteristics for the listed test conditions, unless otherwise noted. Product performance may not be indicated by the Electrical Characteristics if operated under different conditions.

## PACKAGE MARKING AND ORDERING INFORMATION

Device	Package	Shipping <sup>†</sup>
FGD3040G2-F085C	DPAK (Pb-Free)	2500 Units / Tape & Reel
FGB3040G2-F085C	D <sup>2</sup> PAK (Pb-Free)	800 Units / Tape & Reel

<sup>†</sup>For information on tape and reel specifications, including part orientation and tape sizes, please refer to our Tape and Reel Packaging Specifications Brochure, BRD8011/D.

TYPICAL CHARACTERISTICS

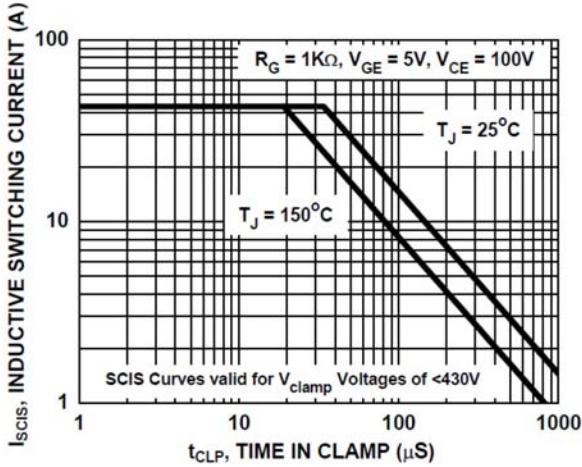

Figure 1. Self Clamped Inductive Switching Current vs. Time in Clamp

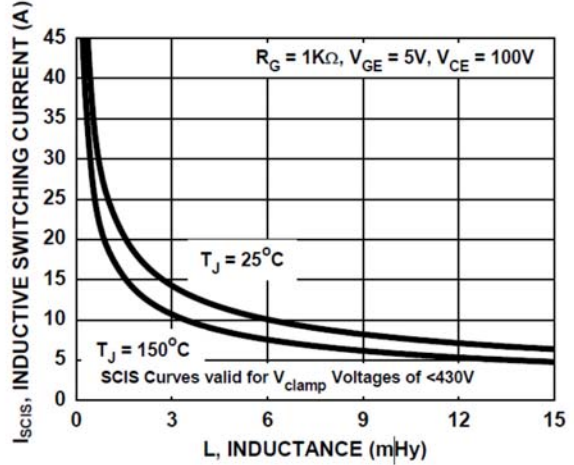

Figure 2. Self Clamped Inductive Switching Current vs. Inductance

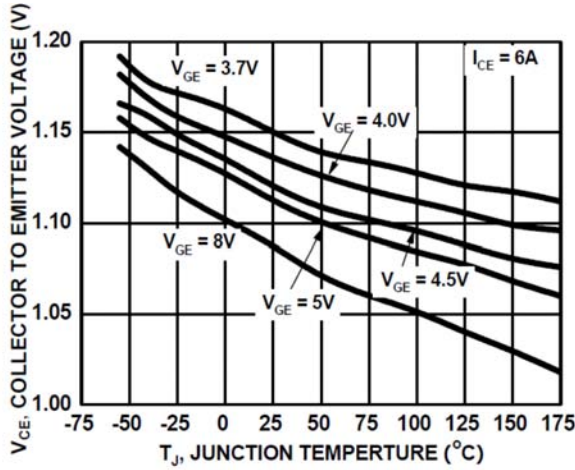

Figure 3. Collector to Emitter On-State Voltage vs. Junction Temperature

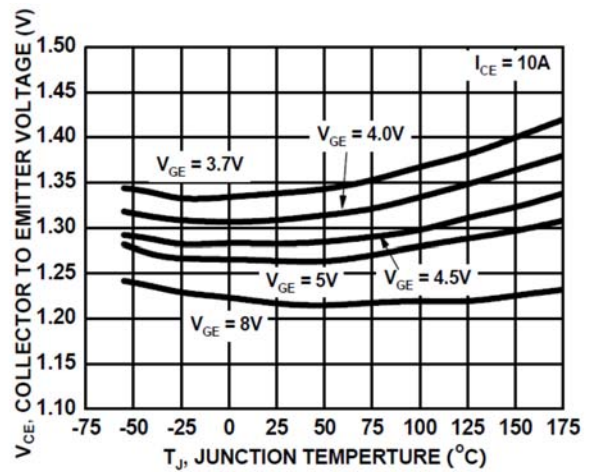

Figure 4. Collector to Emitter On-State Voltage vs. Junction Temperature

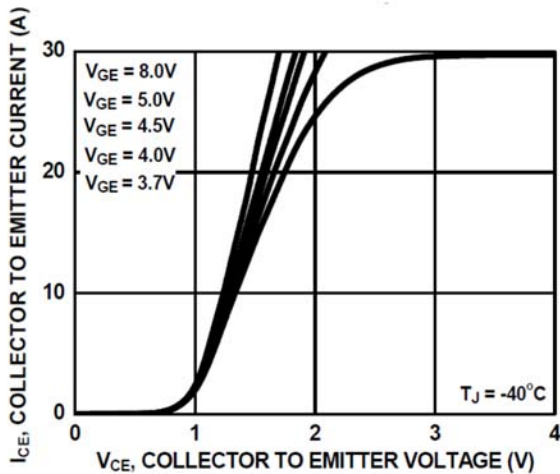

Figure 5. Collector to Emitter On-State Voltage vs. Collector Current

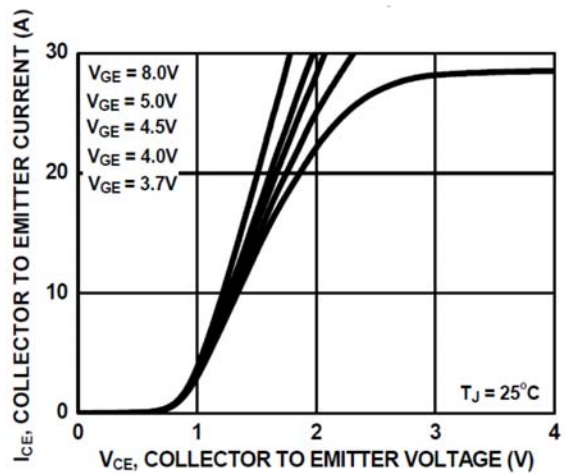

Figure 6. Collector to Emitter On-State Voltage vs. Collector Current

TYPICAL CHARACTERISTICS (continued)

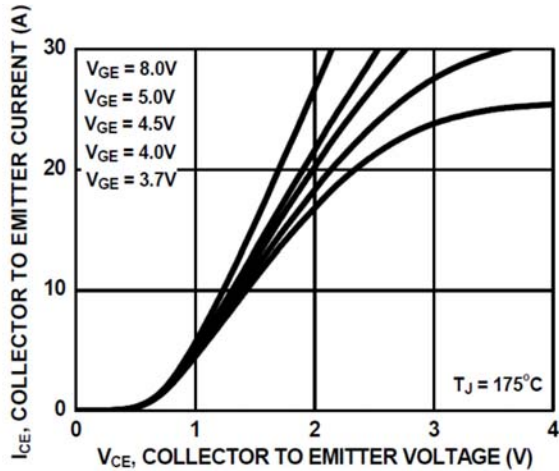

Figure 7. Collector to Emitter On-State Voltage vs. Collector Current

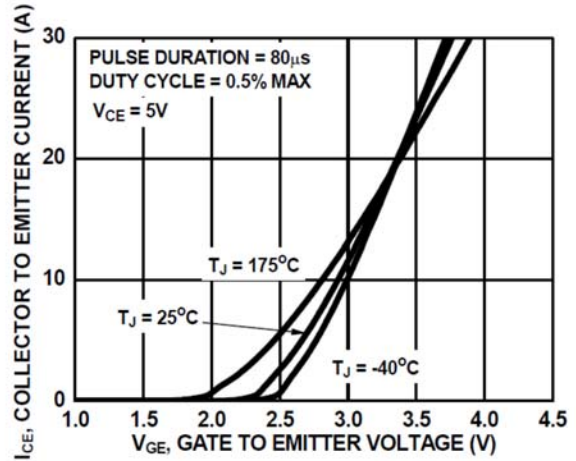

Figure 8. Transfer Characteristics

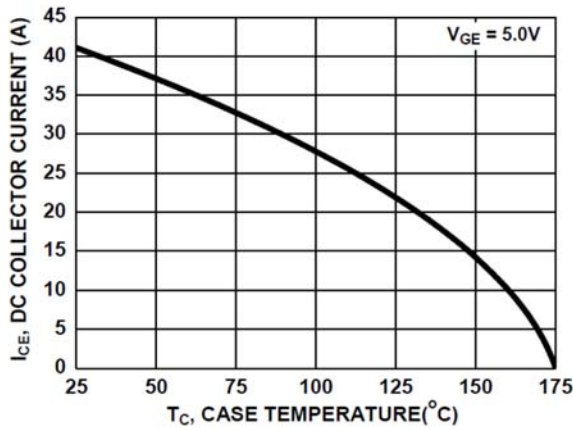

Figure 9. DC Collector Current vs. Case Temperature

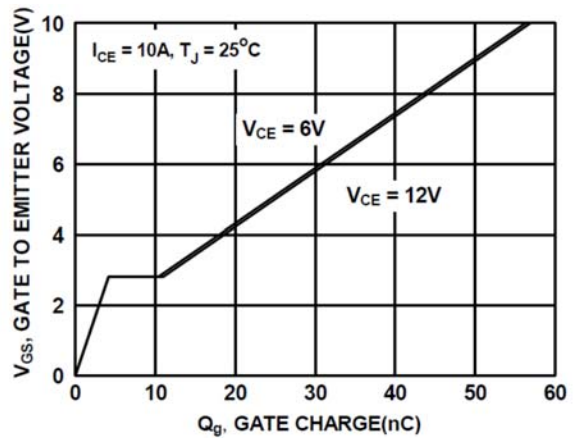

Figure 10. Gate Charge

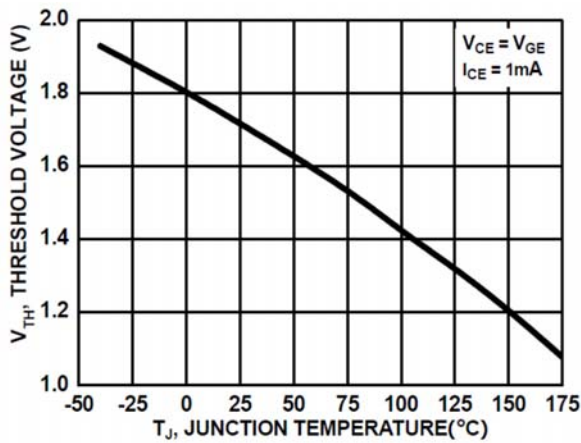

Figure 11. Threshold Voltage vs. Junction Temperature

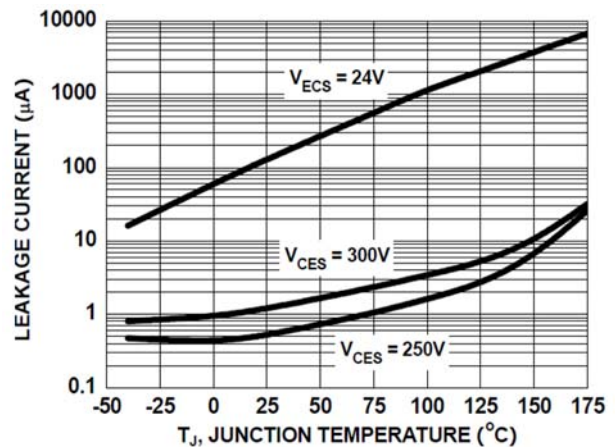

Figure 12. Leakage Current vs. Junction Temperature

# FGD3040G2-F085C

## TYPICAL CHARACTERISTICS (continued)

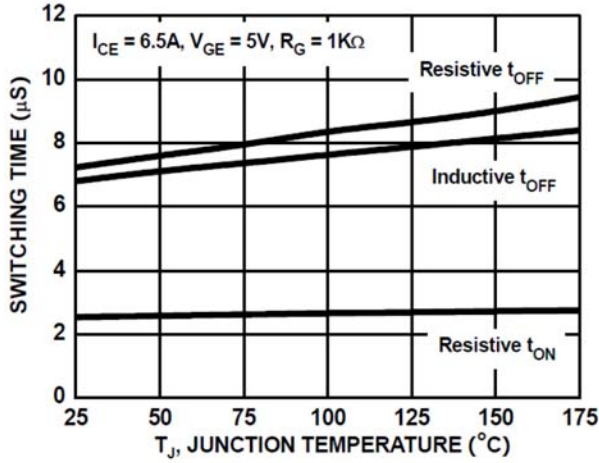

Figure 13. Switching Time vs. Junction Temperature

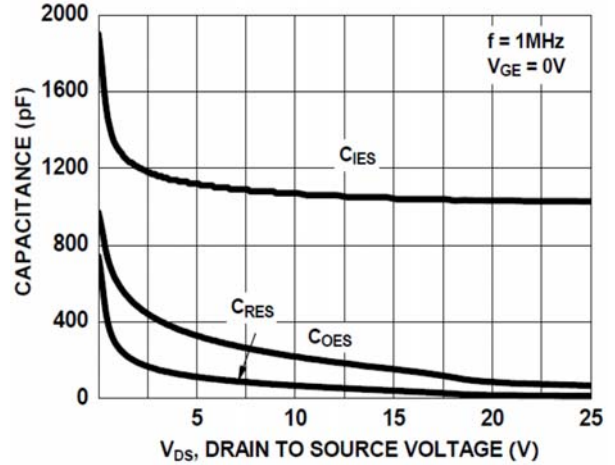

Figure 14. Capacitance vs. Collector to Emitter

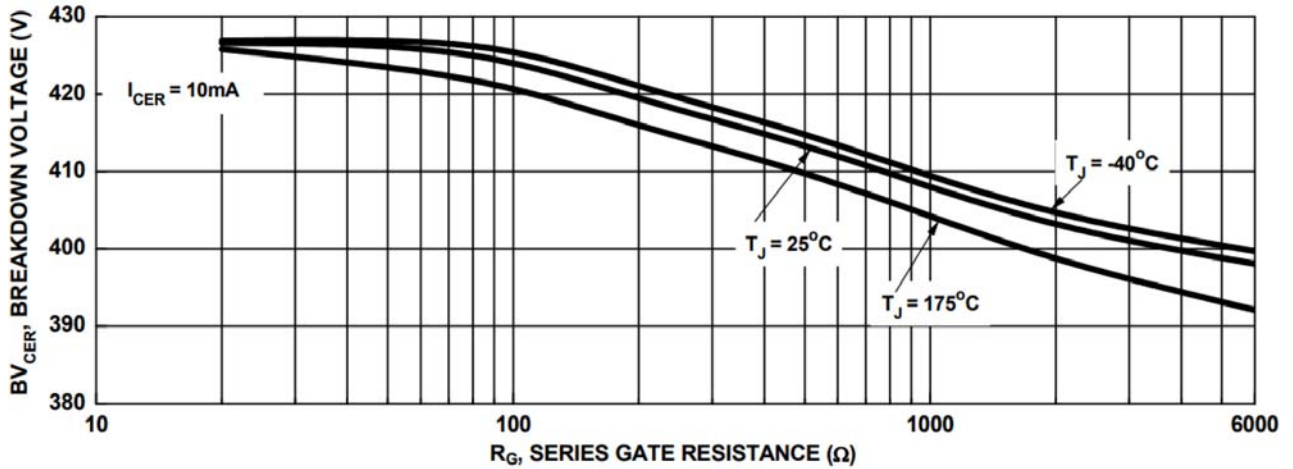

Figure 15. Break Down Voltage vs. Series Resistance

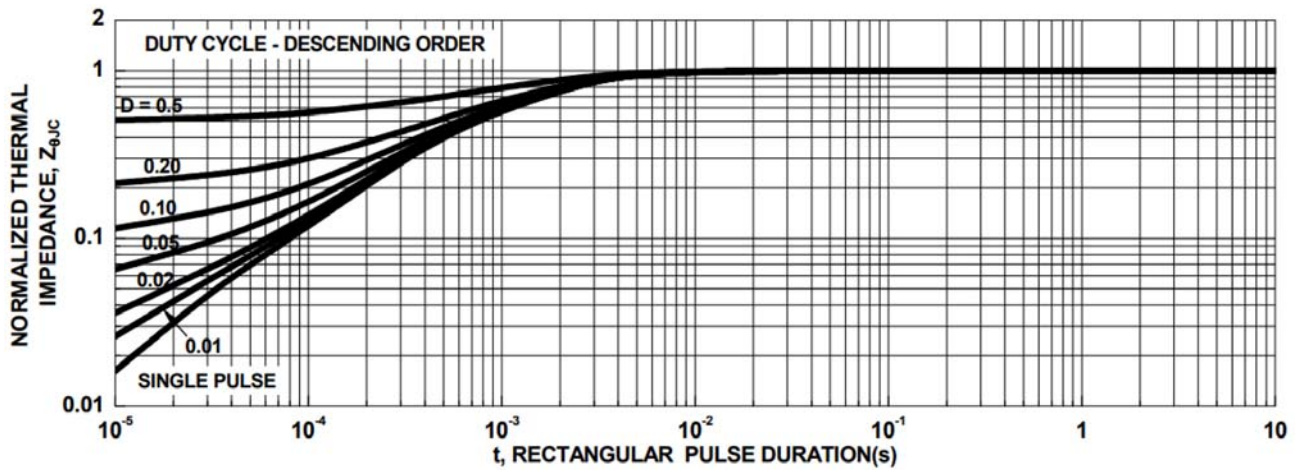

Figure 16. IGBT Normalized Transient Thermal Impedance, Junction to Case

# FGD3040G2-F085C

## TEST CIRCUIT AND WAVEFORMS

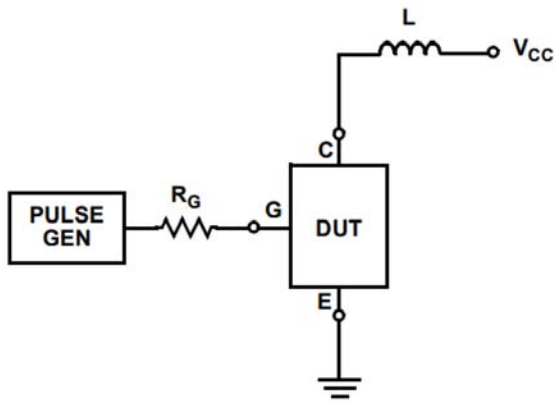

Figure 17. Inductive Switching Test Circuit

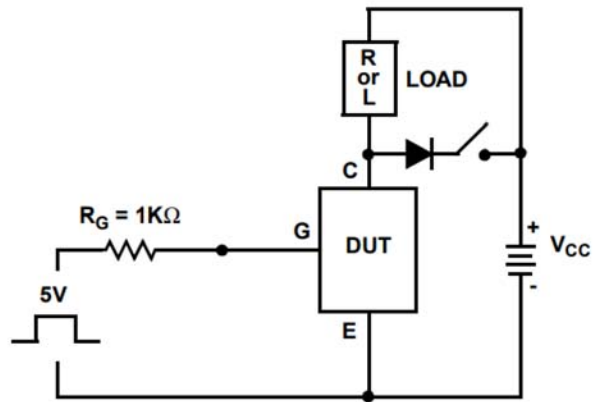

Figure 18.  $t_{ON}$  and  $t_{OFF}$  Switching Test Circuit

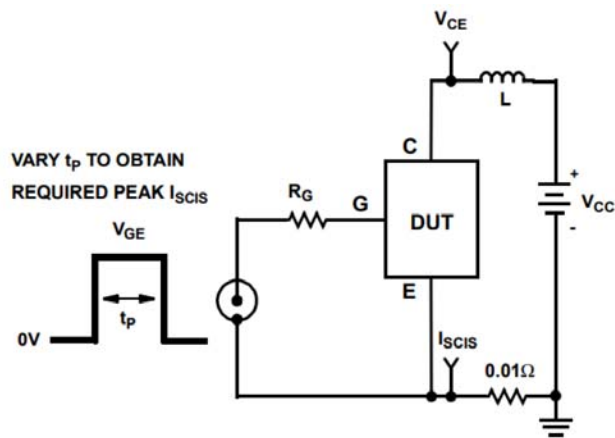

Figure 19. Energy Test Circuit

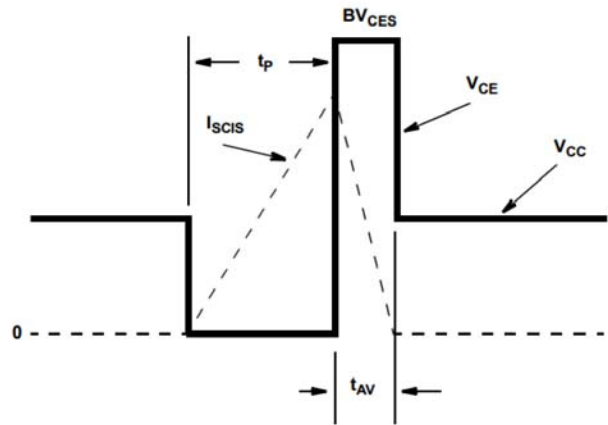

Figure 20. Energy Waveforms

# MECHANICAL CASE OUTLINE PACKAGE DIMENSIONS



## DPAK3 6.10x6.54x2.29, 4.57P CASE 369AS ISSUE B

DATE 20 DEC 2023



- NOTES: UNLESS OTHERWISE SPECIFIED
- A) THIS PACKAGE CONFORMS TO JEDEC, TO-252, ISSUE F, VARIATION AA.
  - B) ALL DIMENSIONS ARE IN MILLIMETERS.
  - C) DIMENSIONING AND TOLERANCING PER ASME Y14.5M-2018.
  - D) SUPPLIER DEPENDENT MOLD LOCKING HOLES OR CHAMFERED CORNERS OR EDGE PROTRUSION.
  - E) FOR DIODE PRODUCTS, L4 IS 0.25 MM MAX PLASTIC BODY STUB WITHOUT CENTER LEAD.
  - F) DIMENSIONS ARE EXCLUSIVE OF BURRS, MOLD FLASH AND TIE BAR EXTRUSIONS.
  - G) LAND PATTERN RECOMMENDATION IS BASED ON IPC7351A STD TD228P991X239-3N.

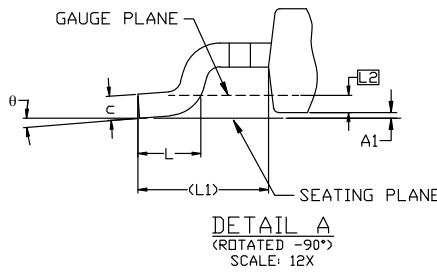

DIM	MILLIMETERS		
	MIN.	NOM.	MAX.
A	2.18	2.29	2.39
A1	0.00	-	0.127
b	0.64	0.77	0.89
b2	0.76	0.95	1.14
b3	5.21	5.34	5.46
c	0.45	0.53	0.61
c2	0.45	0.52	0.58
D	5.97	6.10	6.22
D1	5.21	---	---
E	6.35	6.54	6.73
E1	4.32	---	---
e	2.286 BSC		
e1	4.572 BSC		
H	9.40	9.91	10.41
L	1.40	1.59	1.78
L1	2.90 REF		
L2	0.51 BSC		
L3	0.89	1.08	1.27
L4	---	---	1.02
θ	0°	---	10°



### LAND PATTERN RECOMMENDATION

\*FOR ADDITIONAL INFORMATION ON OUR PB-FREE STRATEGY AND SOLDERING DETAILS, PLEASE DOWNLOAD THE ON SEMICONDUCTOR SOLDERING AND MOUNTING TECHNIQUES REFERENCE MANUAL, SOLDERM/D.

### GENERIC MARKING DIAGRAM\*

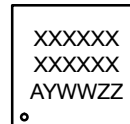

\*This information is generic. Please refer to device data sheet for actual part marking. Pb-free indicator, "G" or microdot "•", may or may not be present. Some products may not follow the Generic Marking.

XXXX = Specific Device Code  
A = Assembly Location  
Y = Year  
WW = Work Week  
ZZ = Assembly Lot Code

<b>DOCUMENT NUMBER:</b>	<b>98AON13810G</b>	Electronic versions are uncontrolled except when accessed directly from the Document Repository. Printed versions are uncontrolled except when stamped "CONTROLLED COPY" in red.
<b>DESCRIPTION:</b>	<b>DPAK3 6.10x6.54x2.29, 4.57P</b>	<b>PAGE 1 OF 1</b>

onsemi and ONSEMI are trademarks of Semiconductor Components Industries, LLC dba onsemi or its subsidiaries in the United States and/or other countries. onsemi reserves the right to make changes without further notice to any products herein. onsemi makes no warranty, representation or guarantee regarding the suitability of its products for any particular purpose, nor does onsemi assume any liability arising out of the application or use of any product or circuit, and specifically disclaims any and all liability, including without limitation special, consequential or incidental damages. onsemi does not convey any license under its patent rights nor the rights of others.

# MECHANICAL CASE OUTLINE

## PACKAGE DIMENSIONS

ON Semiconductor®



SCALE 1:1

### D<sup>2</sup>PAK-3 (TO-263, 3-LEAD)

#### CASE 418AJ

#### ISSUE F

DATE 11 MAR 2021



#### RECOMMENDED MOUNTING FOOTPRINT

■ For additional information on our Pb-Free strategy and soldering details, please download the ON Semiconductor Soldering and Mounting Techniques Reference Manual, SOLDERRM/D.



#### NOTES:

- DIMENSIONING AND TOLERANCING PER ASME Y14.5M, 2009.
- CONTROLLING DIMENSION: INCHES
- CHAMFER OPTIONAL.
- DIMENSIONS D AND E DO NOT INCLUDE MOLD FLASH. MOLD FLASH SHALL NOT EXCEED 0.005 PER SIDE. THESE DIMENSIONS ARE MEASURED AT THE OUTERMOST EXTREMES OF THE PLASTIC BODY AT DATUM H.
- THERMAL PAD CONTOUR IS OPTIONAL WITHIN DIMENSIONS E, L1, D1, AND E1.
- OPTIONAL MOLD FEATURE.
- ①, ② ... OPTIONAL CONSTRUCTION FEATURE CALL OUTS.

DIM	INCHES		MILLIMETERS	
	MIN.	MAX.	MIN.	MAX.
A	0.160	0.190	4.06	4.83
A1	0.000	0.010	0.00	0.25
b	0.020	0.039	0.51	0.99
c	0.012	0.029	0.30	0.74
c2	0.045	0.065	1.14	1.65
D	0.330	0.380	8.38	9.65
D1	0.260	---	6.60	---
E	0.380	0.420	9.65	10.67
E1	0.245	---	6.22	---
e	0.100	BSC	2.54	BSC
H	0.575	0.625	14.60	15.88
L	0.070	0.110	1.78	2.79
L1	---	0.066	---	1.68
L2	---	0.070	---	1.78
L3	0.010	BSC	0.25	BSC
M	0*	8*	0*	8*

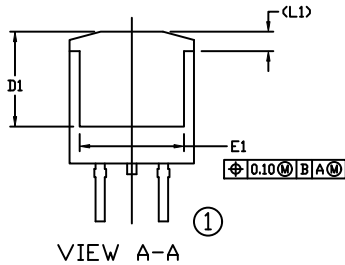
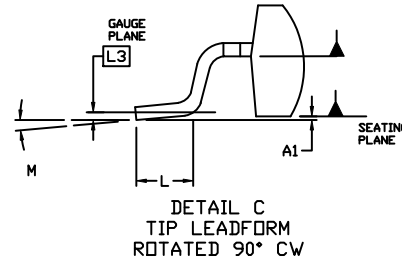

VIEW A-A

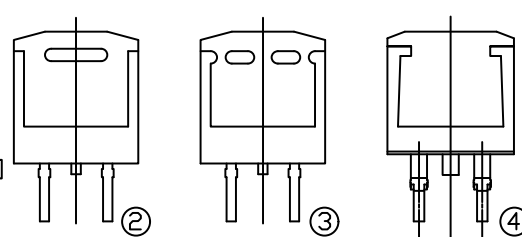

VIEW A-A  
OPTIONAL CONSTRUCTIONS

#### GENERIC MARKING DIAGRAMS\*

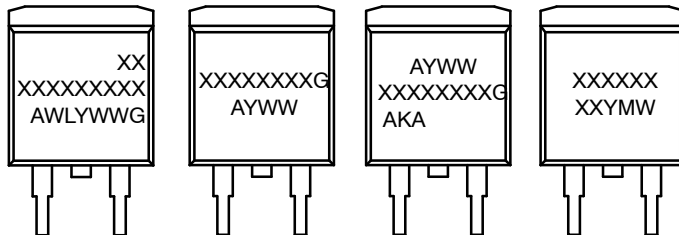

IC

Standard

Rectifier

SSG

- XXXXXX = Specific Device Code
- A = Assembly Location
- WL = Wafer Lot
- Y = Year
- WW = Work Week
- W = Week Code (SSG)
- M = Month Code (SSG)
- G = Pb-Free Package
- AKA = Polarity Indicator

\*This information is generic. Please refer to device data sheet for actual part marking. Pb-Free indicator, "G" or microdot "▪", may or may not be present. Some products may not follow the Generic Marking.

DOCUMENT NUMBER:	98AON56370E	Electronic versions are uncontrolled except when accessed directly from the Document Repository. Printed versions are uncontrolled except when stamped "CONTROLLED COPY" in red.
DESCRIPTION:	D <sup>2</sup> PAK-3 (TO-263, 3-LEAD)	PAGE 1 OF 1

ON Semiconductor and ON are trademarks of Semiconductor Components Industries, LLC dba ON Semiconductor or its subsidiaries in the United States and/or other countries. ON Semiconductor reserves the right to make changes without further notice to any products herein. ON Semiconductor makes no warranty, representation or guarantee regarding the suitability of its products for any particular purpose, nor does ON Semiconductor assume any liability arising out of the application or use of any product or circuit, and specifically disclaims any and all liability, including without limitation special, consequential or incidental damages. ON Semiconductor does not convey any license under its patent rights nor the rights of others.



**onsemi**, **Onsemi**, and other names, marks, and brands are registered and/or common law trademarks of Semiconductor Components Industries, LLC dba "**onsemi**" or its affiliates and/or subsidiaries in the United States and/or other countries. **onsemi** owns the rights to a number of patents, trademarks, copyrights, trade secrets, and other intellectual property. A listing of **onsemi**'s product/patent coverage may be accessed at [www.onsemi.com/site/pdf/Patent-Marking.pdf](http://www.onsemi.com/site/pdf/Patent-Marking.pdf). **onsemi** reserves the right to make changes at any time to any products or information herein, without notice. The information herein is provided "as-is" and **onsemi** makes no warranty, representation or guarantee regarding the accuracy of the information, product features, availability, functionality, or suitability of its products for any particular purpose, nor does **onsemi** assume any liability arising out of the application or use of any product or circuit, and specifically disclaims any and all liability, including without limitation special, consequential or incidental damages. Buyer is responsible for its products and applications using **onsemi** products, including compliance with all laws, regulations and safety requirements or standards, regardless of any support or applications information provided by **onsemi**. "Typical" parameters which may be provided in **onsemi** data sheets and/or specifications can and do vary in different applications and actual performance may vary over time. All operating parameters, including "Typicals" must be validated for each customer application by customer's technical experts. **onsemi** does not convey any license under any of its intellectual property rights nor the rights of others. **onsemi** products are not designed, intended, or authorized for use as a critical component in life support systems or any FDA Class 3 medical devices or medical devices with a same or similar classification in a foreign jurisdiction or any devices intended for implantation in the human body. Should Buyer purchase or use **onsemi** products for any such unintended or unauthorized application, Buyer shall indemnify and hold **onsemi** and its officers, employees, subsidiaries, affiliates, and distributors harmless against all claims, costs, damages, and expenses, and reasonable attorney fees arising out of, directly or indirectly, any claim of personal injury or death associated with such unintended or unauthorized use, even if such claim alleges that **onsemi** was negligent regarding the design or manufacture of the part. **onsemi** is an Equal Opportunity/Affirmative Action Employer. This literature is subject to all applicable copyright laws and is not for resale in any manner.

## ADDITIONAL INFORMATION

### TECHNICAL PUBLICATIONS:

Technical Library: [www.onsemi.com/design/resources/technical-documentation](http://www.onsemi.com/design/resources/technical-documentation)  
onsemi Website: [www.onsemi.com](http://www.onsemi.com)

### ONLINE SUPPORT: [www.onsemi.com/support](http://www.onsemi.com/support)

For additional information, please contact your local Sales Representative at [www.onsemi.com/support/sales](http://www.onsemi.com/support/sales)