

ECOSPARK[®] 2 300 mJ, 400 V, N-Channel Ignition IGBT

FGB3040G2-F085, FGD3040G2-F085, FGP3040G2-F085, FGI3040G2-F085

Features

- SCIS Energy = 300 mJ at T_J = 25°C
- Logic Level Gate Drive
- AEC-Q101 Qualified and PPAP Capable
- These Devices are Pb-Free and are RoHS Compliant

Applications

- Automotive Ignition Coil Driver Circuits
- Coil On Plug Applications

SYMBOL

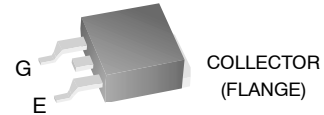
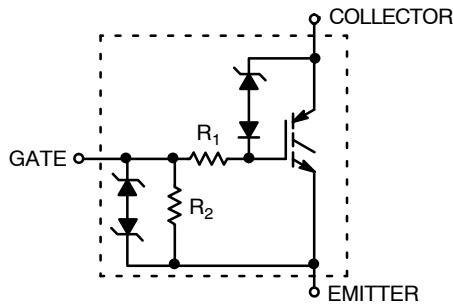

JEDEC TO-263AB
D²PAK-3 (TO-263, 3-LEAD)
CASE 418AJ

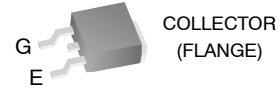

JEDEC TO-263AA
DPAK3 (TO-252 3 LD)
CASE 369AS

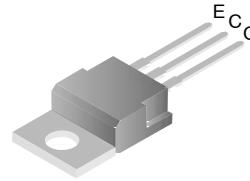

JEDEC TO-220AB
TO-220-3LD
CASE 340AT

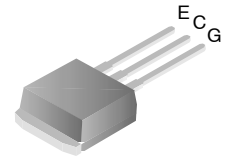

JEDEC TO-262AA
I2PAK (TO-262 3 LD)
CASE 418AV

MARKING DIAGRAMS

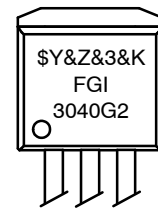
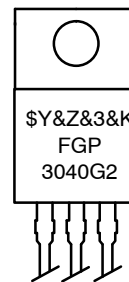
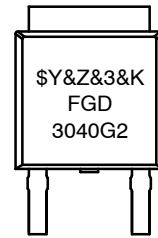
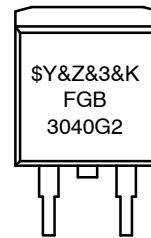

FGx3040G2 = Specific Device Code (x = B/D/P/I)
\$Y = onsemi Logo
&Z = Assembly Plant Code
&3 = 3-Digit Date Code
&K = 2-Digits Lot Run Traceability Code

ORDERING INFORMATION

See detailed ordering and shipping information on page 8 of this data sheet.

FGB3040G2-F085, FGD3040G2-F085, FGP3040G2-F085, FGI3040G2-F085

DEVICE MAXIMUM RATINGS ($T_A = 25^\circ\text{C}$ unless otherwise noted)

| Symbol | Parameter | Rating | Unit |
|---------------|--|----------------------|---------------------|
| BV_{CER} | Collector to Emitter Breakdown Voltage ($I_C = 1\text{ mA}$) | 400 | V |
| BV_{ECS} | Emitter to Collector Voltage - Reverse Battery Condition ($I_C = 10\text{ mA}$) | 28 | V |
| E_{SCIS25} | Self Clamping Inductive Switching Energy (Note 1) | 300 | mJ |
| $E_{SCIS150}$ | Self Clamping Inductive Switching Energy (Note 2) | 170 | mJ |
| I_{C25} | Collector Current Continuous, at $V_{GE} = 5.0\text{ V}$, $T_C = 25^\circ\text{C}$ | 41 | A |
| I_{C110} | Collector Current Continuous, at $V_{GE} = 5.0\text{ V}$, $T_C = 110^\circ\text{C}$ | 25.6 | A |
| V_{GEM} | Gate to Emitter Voltage Continuous | ± 10 | V |
| P_D | Power Dissipation Total, at $T_C = 25^\circ\text{C}$ | 150 | W |
| | Power Dissipation Derating, for $T_C > 25^\circ\text{C}$ | 1 | W/ $^\circ\text{C}$ |
| T_J | Operating Junction Temperature Range | $-55\text{ to }+175$ | $^\circ\text{C}$ |
| T_{STG} | Storage Junction Temperature Range | $-55\text{ to }+175$ | $^\circ\text{C}$ |
| T_L | Max. Lead Temp. for Soldering (Leads at 1.6 mm from case for 10 s) | 300 | $^\circ\text{C}$ |
| T_{PKG} | Reflow Soldering according to JESD020C | 260 | $^\circ\text{C}$ |
| ESD | HBM-Electrostatic Discharge Voltage at 100 pF, 1500 Ω | 4 | kV |
| | CDM-Electrostatic Discharge Voltage at 1 Ω | 2 | kV |

Stresses exceeding those listed in the Maximum Ratings table may damage the device. If any of these limits are exceeded, device functionality should not be assumed, damage may occur and reliability may be affected.

1. Self Clamping Inductive Switching Energy (E_{SCIS25}) of 300 mJ is based on the test conditions that starting $T_J = 25^\circ\text{C}$; $L = 3\text{ mHy}$, $I_{SCIS} = 14.2\text{ A}$, $V_{CC} = 100\text{ V}$ during inductor charging and $V_{CC} = 0\text{ V}$ during the time in clamp.
2. Self Clamping Inductive Switching Energy ($E_{SCIS150}$) of 170 mJ is based on the test conditions that starting $T_J = 150^\circ\text{C}$; $L = 3\text{ mHy}$, $I_{SCIS} = 10.8\text{ A}$, $V_{CC} = 100\text{ V}$ during inductor charging and $V_{CC} = 0\text{ V}$ during the time in clamp.

FGB3040G2–F085, FGD3040G2–F085, FGP3040G2–F085, FGI3040G2–F085

ELECTRICAL CHARACTERISTICS ($T_J = 25^\circ\text{C}$ unless otherwise noted)

| Symbol | Parameter | Test Conditions | Min | Typ | Max | Unit |
|--------|-----------|-----------------|-----|-----|-----|------|
|--------|-----------|-----------------|-----|-----|-----|------|

OFF STATE CHARACTERISTICS

| | | | | | | | |
|------------|--|--|---------------------------|----------|-----|----------|---------------|
| BV_{CER} | Collector to Emitter Breakdown Voltage | $I_{CE} = 2\text{ mA}$, $V_{GE} = 0$, $R_{GE} = 1\text{ k}\Omega$, $T_J = -40\text{ to }150^\circ\text{C}$ | 370 | 400 | 430 | V | |
| BV_{CES} | Collector to Emitter Breakdown Voltage | $I_{CE} = 10\text{ mA}$, $V_{GE} = 0\text{ V}$, $R_{GE} = 0$, $T_J = -40\text{ to }150^\circ\text{C}$ | 390 | 420 | 450 | V | |
| BV_{ECS} | Emitter to Collector Breakdown Voltage | $I_{CE} = -20\text{ mA}$, $V_{GE} = 0\text{ V}$, $T_J = 25^\circ\text{C}$ | 28 | – | – | V | |
| BV_{GES} | Gate to Emitter Breakdown Voltage | $I_{GES} = \pm 2\text{ mA}$ | ± 12 | ± 14 | – | V | |
| I_{CER} | Collector to Emitter Leakage Current | $V_{CE} = 250\text{ V}$, $R_{GE} = 1\text{ k}\Omega$ | $T_J = 25^\circ\text{C}$ | – | – | 25 | μA |
| | | | $T_J = 150^\circ\text{C}$ | – | – | 1 | mA |
| I_{ECS} | Emitter to Collector Leakage Current | $V_{EC} = 24\text{ V}$ | $T_J = 25^\circ\text{C}$ | – | – | 1 | mA |
| | | | $T_J = 150^\circ\text{C}$ | – | – | 40 | |
| R_1 | Series Gate Resistance | | – | 120 | – | Ω | |
| R_2 | Gate to Emitter Resistance | | 10K | – | 30K | Ω | |

ON STATE CHARACTERISTICS

| | | | | | | | |
|---------------|---|--|---------------------------|---|------|------|----|
| $V_{CE(SAT)}$ | Collector to Emitter Saturation Voltage | $I_{CE} = 6\text{ A}$, $V_{GE} = 4\text{ V}$ | $T_J = 25^\circ\text{C}$ | – | 1.15 | 1.25 | V |
| $V_{CE(SAT)}$ | Collector to Emitter Saturation Voltage | $I_{CE} = 10\text{ A}$, $V_{GE} = 4.5\text{ V}$ | $T_J = 150^\circ\text{C}$ | – | 1.35 | 1.50 | V |
| $V_{CE(SAT)}$ | Collector to Emitter Saturation Voltage | $I_{CE} = 15\text{ A}$, $V_{GE} = 4.5\text{ V}$ | $T_J = 150^\circ\text{C}$ | – | 1.68 | 1.85 | V |
| E_{SCIS} | Self Clamped Inductive Switching | $L = 3.0\text{ mH}$, $R_G = 1\text{ k}\Omega$, $V_{GE} = 5\text{ V}$, (Note 3) | $T_J = 25^\circ\text{C}$ | – | – | 300 | mJ |

DYNAMIC CHARACTERISTICS

| | | | | | | | |
|--------------|-----------------------------------|---|---------------------------|------|-----|-----|----|
| $Q_{G(ON)}$ | Gate Charge | $I_{CE} = 10\text{ A}$, $V_{CE} = 12\text{ V}$, $V_{GE} = 5\text{ V}$ | | – | 21 | – | nC |
| $V_{GE(TH)}$ | Gate to Emitter Threshold Voltage | $I_{CE} = 1\text{ mA}$, $V_{CE} = V_{GE}$ | $T_J = 25^\circ\text{C}$ | 1.3 | 1.7 | 2.2 | V |
| | | | $T_J = 150^\circ\text{C}$ | 0.75 | 1.2 | 1.8 | |
| V_{GEP} | Gate to Emitter Plateau Voltage | $V_{CE} = 12\text{ V}$, $I_{CE} = 10\text{ A}$ | | – | 2.8 | – | V |

SWITCHING CHARACTERISTICS

| | | | | | | |
|---------------|---------------------------------------|---|---|-----|----|---------------|
| $t_{d(ON)R}$ | Current Turn-On Delay Time–Resistive | $V_{CE} = 14\text{ V}$, $R_L = 1\text{ k}\Omega$, $V_{GE} = 5\text{ V}$, $R_G = 1\text{ k}\Omega$, $T_J = 25^\circ\text{C}$ | – | 0.9 | 4 | μs |
| t_{rR} | Current Rise Time–Resistive | | – | 1.9 | 7 | μs |
| $t_{d(OFF)L}$ | Current Turn-Off Delay Time–Inductive | $V_{CE} = 300\text{ V}$, $L = 1\text{ mH}$, $V_{GE} = 5\text{ V}$, $R_G = 1\text{ k}\Omega$, $I_{CE} = 6.5\text{ A}$, $T_J = 25^\circ\text{C}$ | – | 4.8 | 15 | μs |
| t_{fL} | Current Fall Time–Inductive | | – | 2.0 | 15 | μs |

THERMAL CHARACTERISTICS

| | | | | | | |
|-----------------|-------------------------------------|--|---|---|---|--------------------|
| $R_{\theta JC}$ | Thermal Resistance Junction to Case | | – | – | 1 | $^\circ\text{C/W}$ |
|-----------------|-------------------------------------|--|---|---|---|--------------------|

Product parametric performance is indicated in the Electrical Characteristics for the listed test conditions, unless otherwise noted. Product performance may not be indicated by the Electrical Characteristics if operated under different conditions.

- Self Clamping Inductive Switching Energy (E_{SCIS25}) of 300 mJ is based on the test conditions that starting $T_J = 25^\circ\text{C}$; $L = 3\text{ mH}$, $I_{SCIS} = 14.2\text{ A}$, $V_{CC} = 100\text{ V}$ during inductor charging and $V_{CC} = 0\text{ V}$ during the time in clamp.

TYPICAL PERFORMANCE CURVES

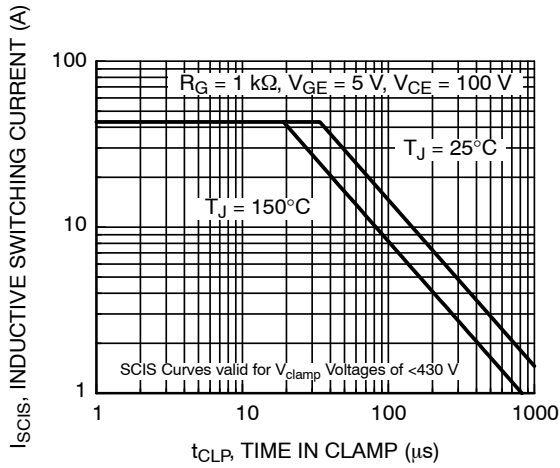

Figure 1. Self Clamped Inductive Switching Current vs. Time in Clamp

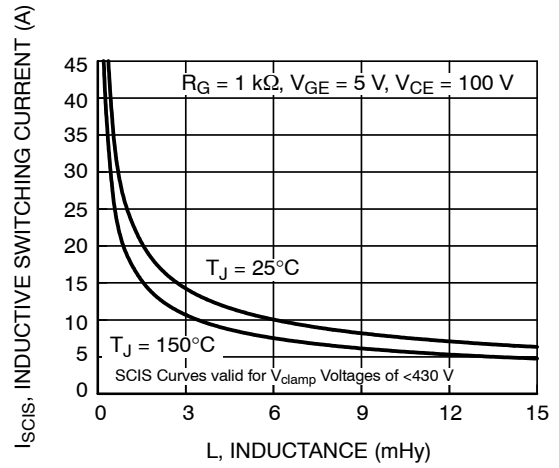

Figure 2. Self Clamped Inductive Switching Current vs. Inductance

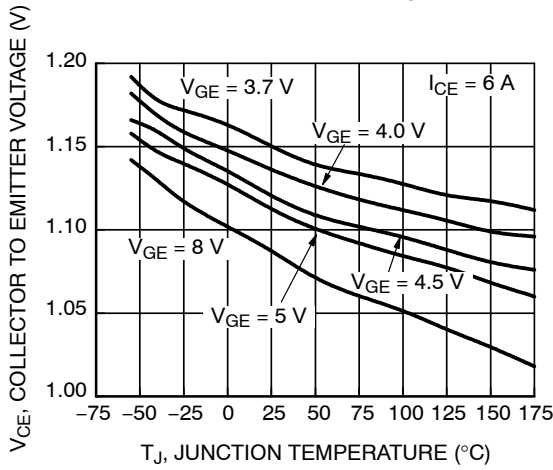

Figure 3. Collector to Emitter On-State Voltage vs. Junction Temperature

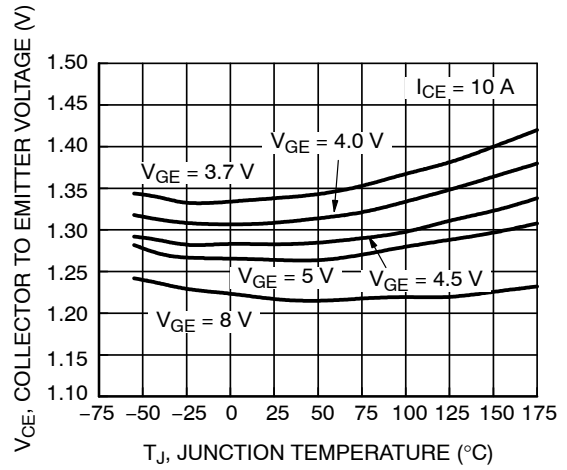

Figure 4. Collector to Emitter On-State Voltage vs. Junction Temperature

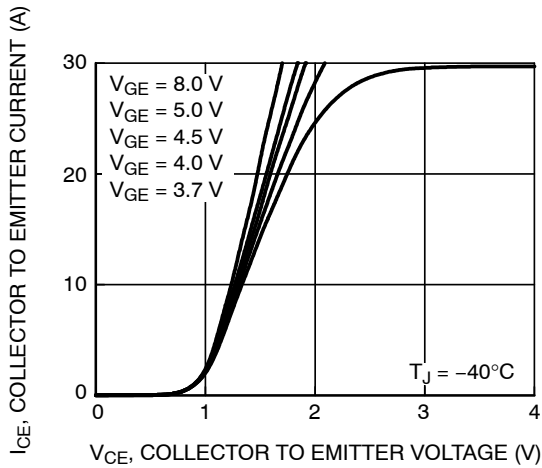

Figure 5. Collector to Emitter On-State Voltage vs. Collector Current

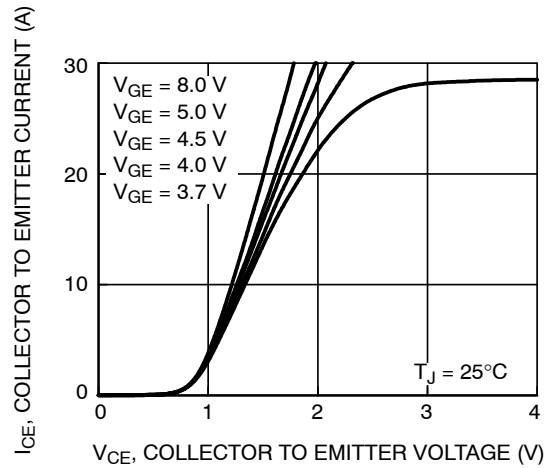

Figure 6. Collector to Emitter On-State Voltage vs. Collector Current

TYPICAL PERFORMANCE CURVES (Continued)

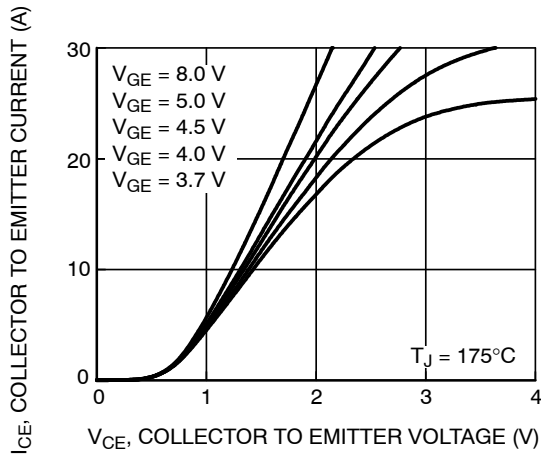

Figure 7. Collector to Emitter On-Stage Voltage vs. Collector Current

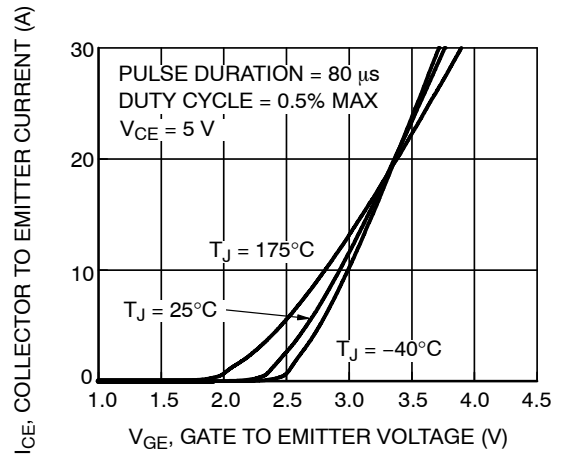

Figure 8. Transfer Characteristics

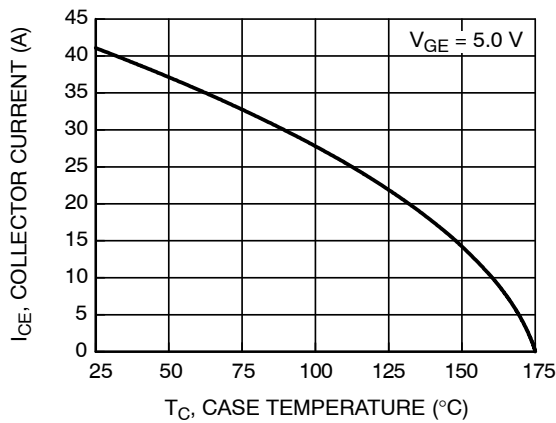

Figure 9. DC Collector Current vs. Case Temperature

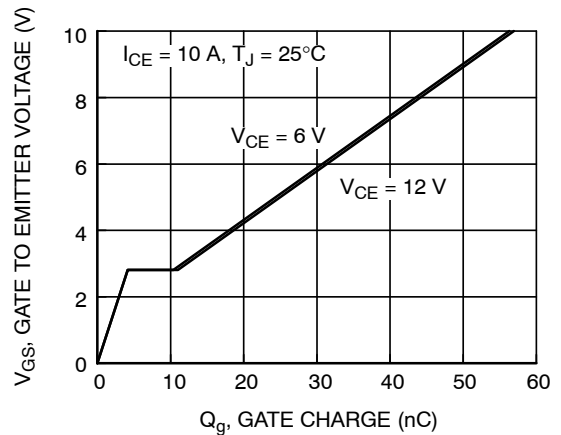

Figure 10. Gate Charge

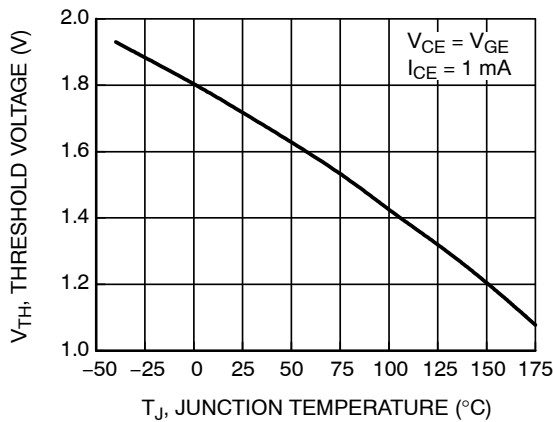

Figure 11. Threshold Voltage vs. Junction Temperature

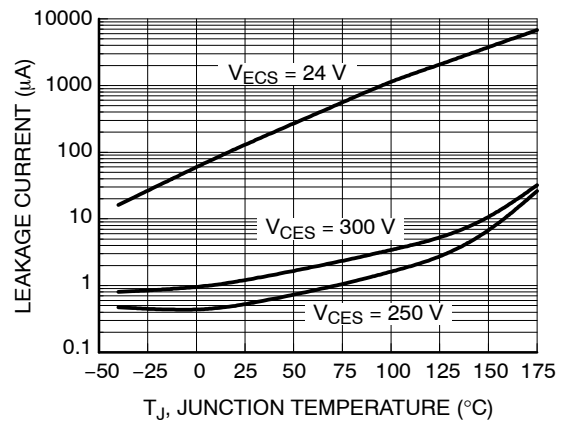

Figure 12. Leakage Current vs. Junction Temperature

TYPICAL PERFORMANCE CURVES (Continued)

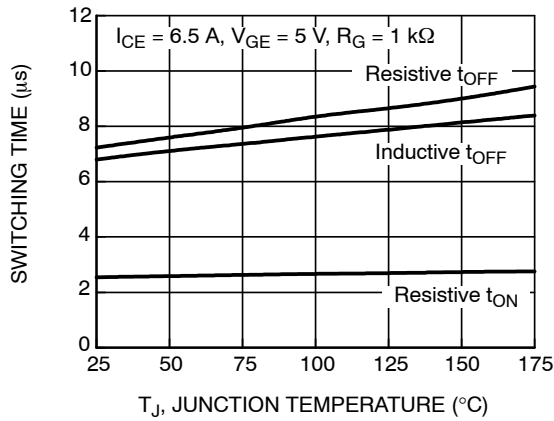

Figure 13. Switching Time vs. Junction Temperature

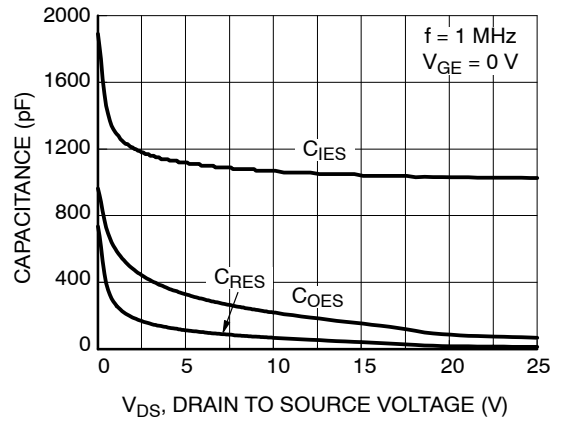

Figure 14. Capacitance vs. Collector to Emitter Voltage

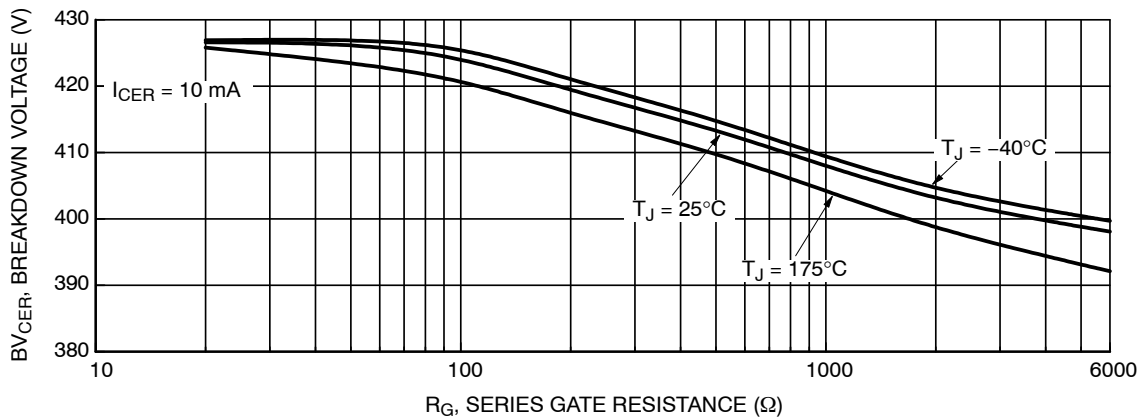

Figure 15. Breakdown Voltage vs. Series Gate Resistance

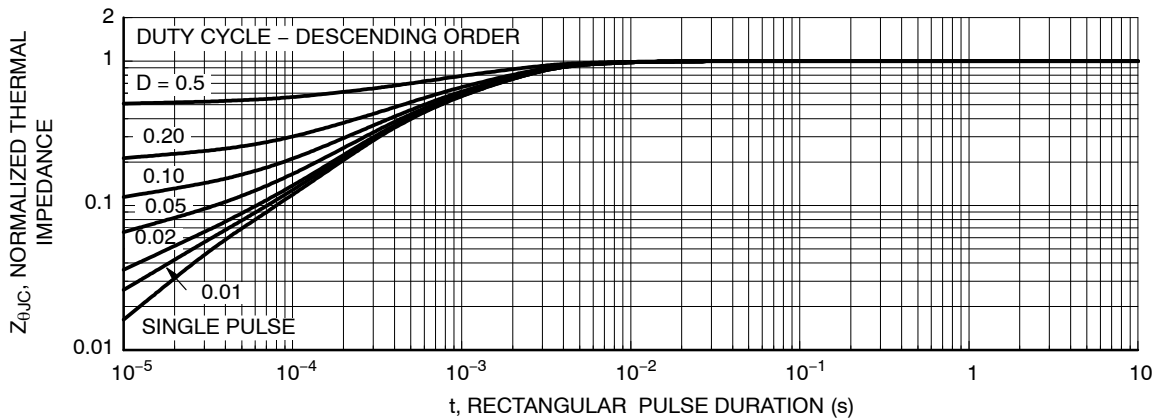

Figure 16. IGBT Normalized Transient Thermal Impedance, Junction to Case

TYPICAL PERFORMANCE CURVES (Continued)

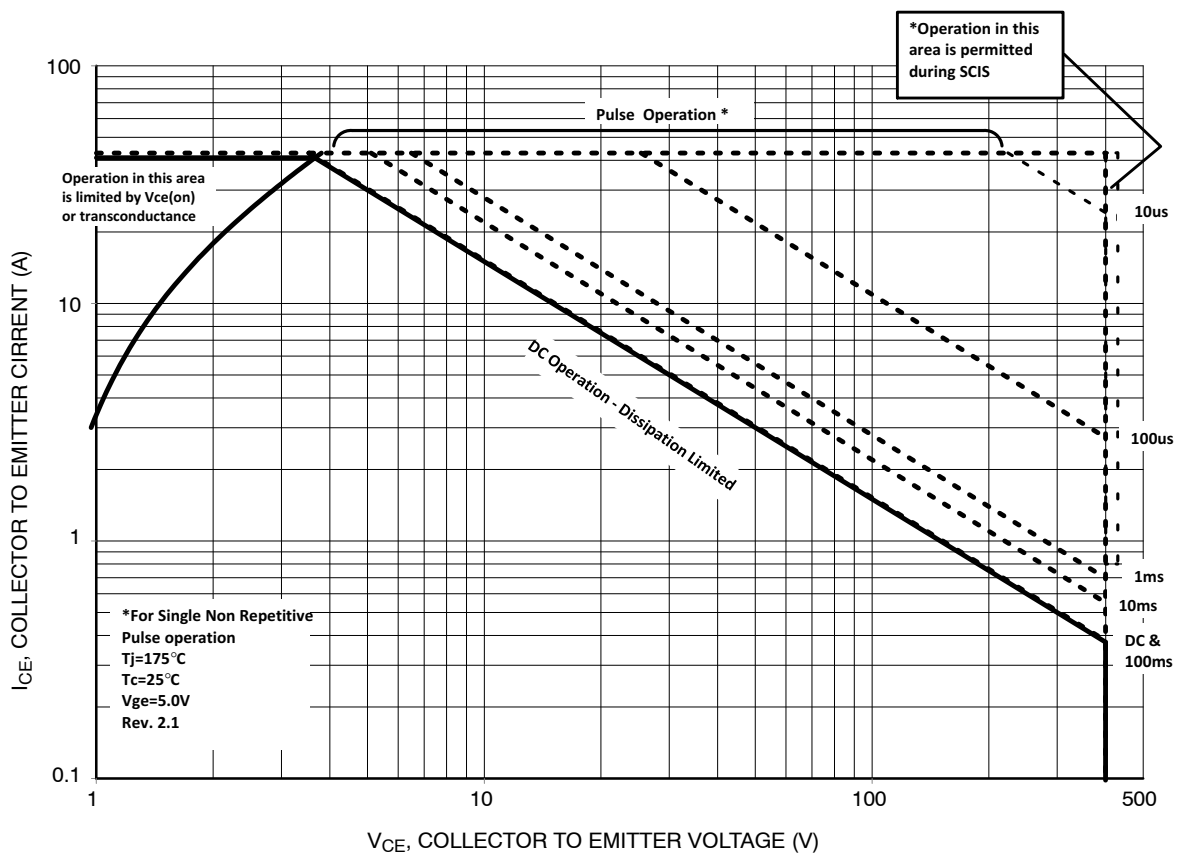

Figure 17. Forward Safe Operating Area

TEST CIRCUIT AND WAVEFORMS

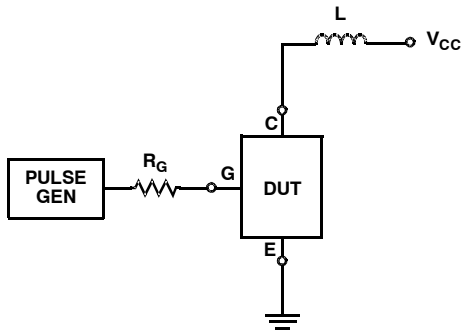

Figure 18. Inductive Switching Test Circuit

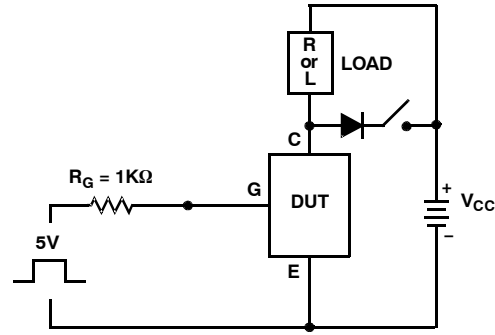

Figure 19. t_{ON} and t_{OFF} Switching Test Circuit

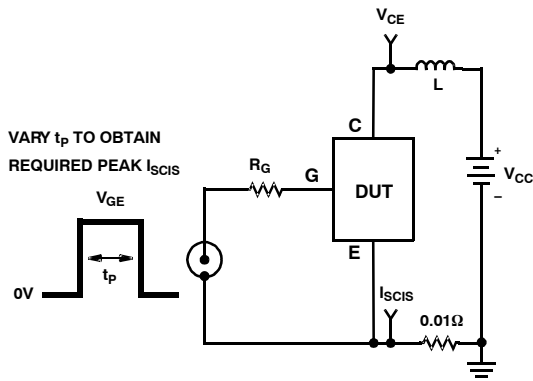

Figure 20. Energy Test Circuit

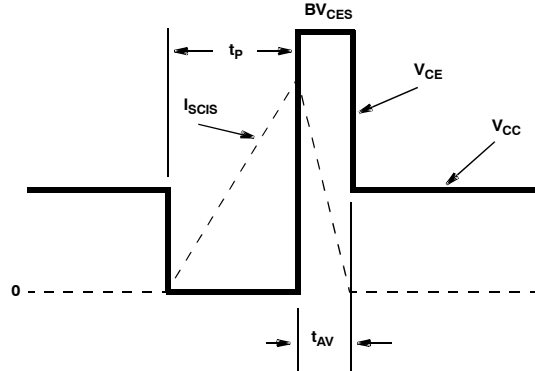

Figure 21. Energy Waveforms

PACKAGE MARKING AND ORDERING INFORMATION

| Device | Device Marking | Package | Shipping [†] |
|----------------|----------------|---|-----------------------|
| FGB3040G2-F085 | FGB3040G2 | D ² PAK-3 (TO-263, 3-LEAD) (TO-263AB) (Pb-Free) | 800 / Tape & Reel |
| FGD3040G2-F085 | FGD3040G2 | DPAK3 (TO-252 3 LD) (TO-252AA) (Pb-Free) | 2500 / Tape & Reel |
| FGP3040G2-F085 | FGP3040G2 | TO-220-3LD (TO-220AB) (Pb-Free) | 400 / Tube |
| FGI3040G2-F085 | FGI3040G2 | I2PAK (TO-262 3 LD) (TO-262AA) (Pb-Free) | 400 / Tube |

[†]For information on tape and reel specifications, including part orientation and tape sizes, please refer to our Tape and Reel Packaging Specifications Brochure, BRD8011/D.

MECHANICAL CASE OUTLINE

PACKAGE DIMENSIONS

ON Semiconductor®

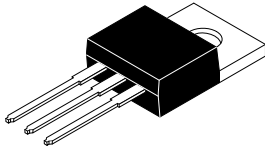

Scale 1:1

TO-220-3LD CASE 340AT ISSUE A

DATE 03 OCT 2017

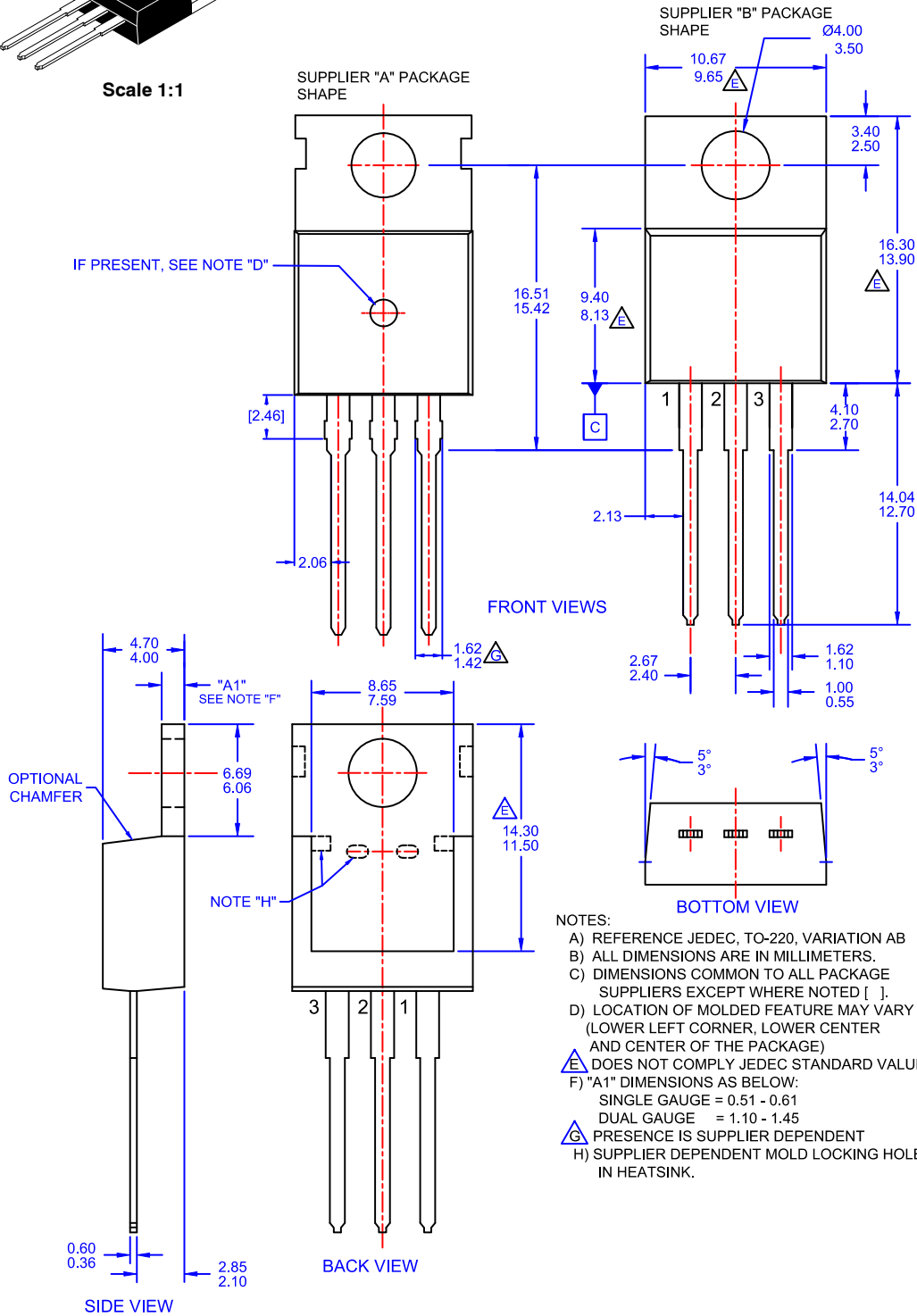

| | | |
|-------------------------|--------------------|--|
| DOCUMENT NUMBER: | 98AON13818G | Electronic versions are uncontrolled except when accessed directly from the Document Repository. Printed versions are uncontrolled except when stamped "CONTROLLED COPY" in red. |
| DESCRIPTION: | TO-220-3LD | PAGE 1 OF 1 |

ON Semiconductor and ON are trademarks of Semiconductor Components Industries, LLC dba ON Semiconductor or its subsidiaries in the United States and/or other countries. ON Semiconductor reserves the right to make changes without further notice to any products herein. ON Semiconductor makes no warranty, representation or guarantee regarding the suitability of its products for any particular purpose, nor does ON Semiconductor assume any liability arising out of the application or use of any product or circuit, and specifically disclaims any and all liability, including without limitation special, consequential or incidental damages. ON Semiconductor does not convey any license under its patent rights nor the rights of others.

MECHANICAL CASE OUTLINE PACKAGE DIMENSIONS

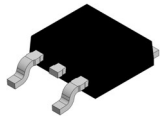

DPAK3 (TO-252 3 LD) CASE 369AS ISSUE A

DATE 28 SEP 2022

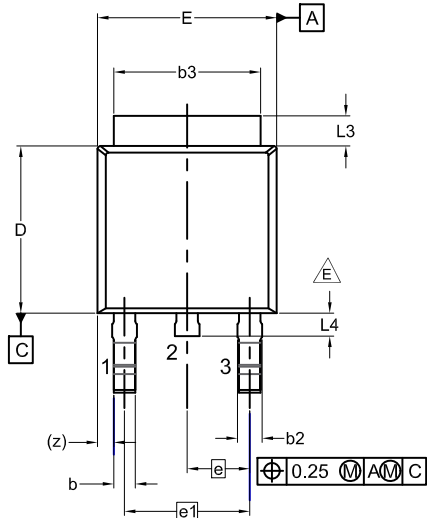

- NOTES: UNLESS OTHERWISE SPECIFIED
 A) THIS PACKAGE CONFORMS TO JEDEC, TO-252, ISSUE C, VARIATION AA.
 B) ALL DIMENSIONS ARE IN MILLIMETERS.
 C) DIMENSIONING AND TOLERANCING PER ASME Y14.5M-2009.
 D) SUPPLIER DEPENDENT MOLD LOCKING HOLES OR CHAMFERED CORNERS OR EDGE PROTRUSION.
 E) FOR DIODE PRODUCTS, L4 IS 0.25 MM MAX.
 F) DIMENSIONS ARE EXCLUSIVE OF BURRS, MOLD FLASH AND TIE BAR EXTRUSIONS.
 G) LAND PATTERN RECOMMENDATION IS BASED ON IPC7351A STD TO228P991X239-3N.

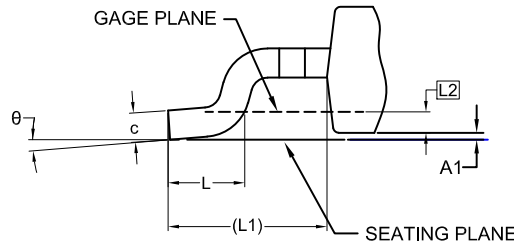

DETAIL A
(ROTATED -90°)
SCALE: 12X

| DIM | MILLIMETERS | | |
|-----|-------------|------|-------|
| | MIN. | NOM. | MAX. |
| A | 2.18 | 2.29 | 2.39 |
| A1 | 0.00 | - | 0.127 |
| b | 0.64 | 0.77 | 0.89 |
| b2 | 0.76 | 0.95 | 1.14 |
| b3 | 5.21 | 5.34 | 5.46 |
| c | 0.45 | 0.53 | 0.61 |
| c2 | 0.45 | 0.52 | 0.58 |
| D | 5.97 | 6.10 | 6.22 |
| D1 | 5.21 | - | - |
| E | 6.35 | 6.54 | 6.73 |
| E1 | 4.32 | - | - |
| e | 2.286 BSC | | |
| e1 | 4.572 BSC | | |
| H | 9.40 | 9.91 | 10.41 |
| L | 1.40 | 1.59 | 1.78 |
| L1 | 2.90 REF | | |
| L2 | 0.51 BSC | | |
| L3 | 0.89 | 1.08 | 1.27 |
| L4 | - | - | 1.02 |
| θ | 0° | -- | 10° |

NON-DIODE PRODUCTS VERSION

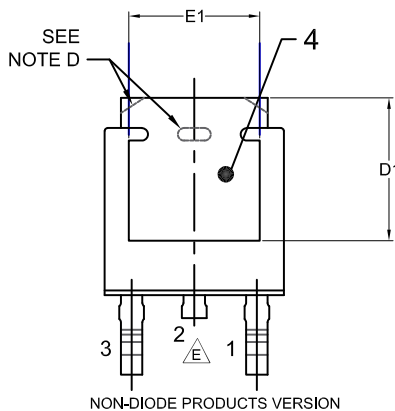

NON-DIODE PRODUCTS VERSION

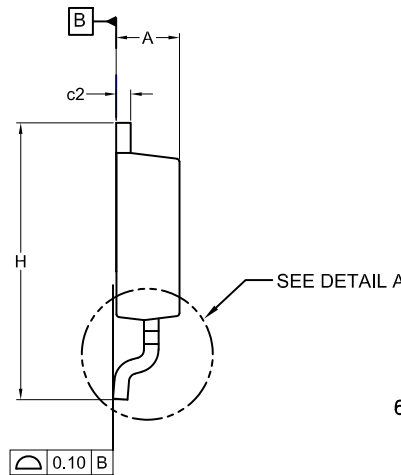

GENERIC MARKING DIAGRAM*



- XXXX = Specific Device Code
- A = Assembly Location
- Y = Year
- WW = Work Week
- ZZ = Assembly Lot Code

*This information is generic. Please refer to device data sheet for actual part marking. Pb-free indicator, "G" or microdot "•", may or may not be present. Some products may not follow the Generic Marking.

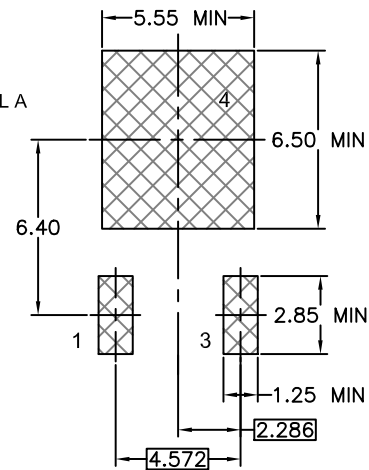

LAND PATTERN RECOMMENDATION

*FOR ADDITIONAL INFORMATION ON OUR PB-FREE STRATEGY AND SOLDERING DETAILS, PLEASE DOWNLOAD THE ON SEMICONDUCTOR SOLDERING AND MOUNTING TECHNIQUES REFERENCE MANUAL, SOLDERRM/D.

| | | |
|-------------------------|----------------------------|--|
| DOCUMENT NUMBER: | 98AON13810G | Electronic versions are uncontrolled except when accessed directly from the Document Repository. Printed versions are uncontrolled except when stamped "CONTROLLED COPY" in red. |
| DESCRIPTION: | DPAK3 (TO-252 3 LD) | PAGE 1 OF 1 |

onsemi and ONSEMI are trademarks of Semiconductor Components Industries, LLC dba onsemi or its subsidiaries in the United States and/or other countries. onsemi reserves the right to make changes without further notice to any products herein. onsemi makes no warranty, representation or guarantee regarding the suitability of its products for any particular purpose, nor does onsemi assume any liability arising out of the application or use of any product or circuit, and specifically disclaims any and all liability, including without limitation special, consequential or incidental damages. onsemi does not convey any license under its patent rights nor the rights of others.

MECHANICAL CASE OUTLINE

PACKAGE DIMENSIONS

ON Semiconductor®

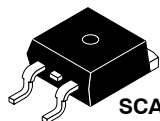

SCALE 1:1

D²PAK-3 (TO-263, 3-LEAD)

CASE 418AJ

ISSUE F

DATE 11 MAR 2021

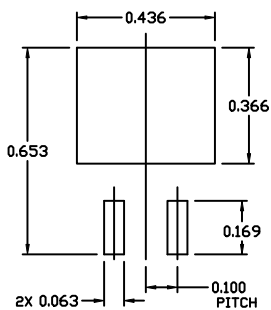

RECOMMENDED MOUNTING FOOTPRINT

For additional information on our Pb-Free strategy and soldering details, please download the ON Semiconductor Soldering and Mounting Techniques Reference Manual, SOLDERRM/D.

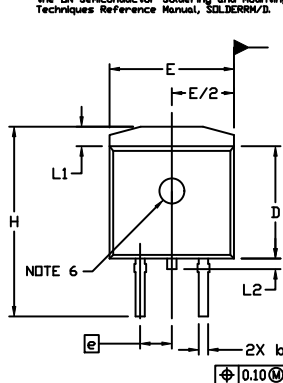

NOTES:

- DIMENSIONING AND TOLERANCING PER ASME Y14.5M, 2009.
- CONTROLLING DIMENSION: INCHES
- CHAMFER OPTIONAL.
- DIMENSIONS D AND E DO NOT INCLUDE MOLD FLASH. MOLD FLASH SHALL NOT EXCEED 0.005 PER SIDE. THESE DIMENSIONS ARE MEASURED AT THE OUTERMOST EXTREMES OF THE PLASTIC BODY AT DATUM H.
- THERMAL PAD CONTOUR IS OPTIONAL WITHIN DIMENSIONS E, L1, D1, AND E1.
- OPTIONAL MOLD FEATURE.
- ①, ② ... OPTIONAL CONSTRUCTION FEATURE CALL OUTS.

| DIM | INCHES | | MILLIMETERS | |
|-----|--------|-------|-------------|-------|
| | MIN. | MAX. | MIN. | MAX. |
| A | 0.160 | 0.190 | 4.06 | 4.83 |
| A1 | 0.000 | 0.010 | 0.00 | 0.25 |
| b | 0.020 | 0.039 | 0.51 | 0.99 |
| c | 0.012 | 0.029 | 0.30 | 0.74 |
| c2 | 0.045 | 0.065 | 1.14 | 1.65 |
| D | 0.330 | 0.380 | 8.38 | 9.65 |
| D1 | 0.260 | --- | 6.60 | --- |
| E | 0.380 | 0.420 | 9.65 | 10.67 |
| E1 | 0.245 | --- | 6.22 | --- |
| e | 0.100 | BSC | 2.54 | BSC |
| H | 0.575 | 0.625 | 14.60 | 15.88 |
| L | 0.070 | 0.110 | 1.78 | 2.79 |
| L1 | --- | 0.066 | --- | 1.68 |
| L2 | --- | 0.070 | --- | 1.78 |
| L3 | 0.010 | BSC | 0.25 | BSC |
| M | 0* | 8* | 0* | 8* |

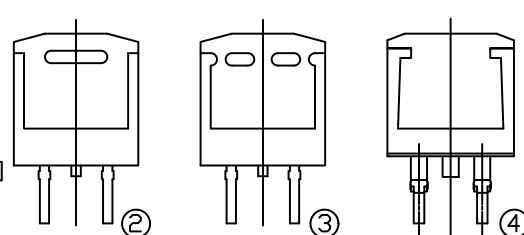
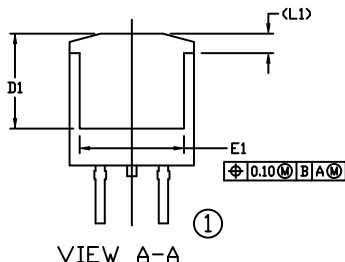
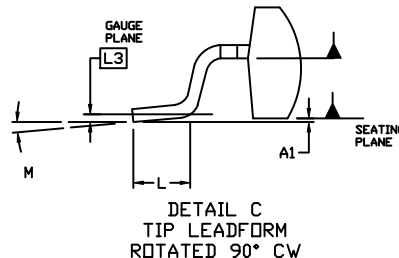
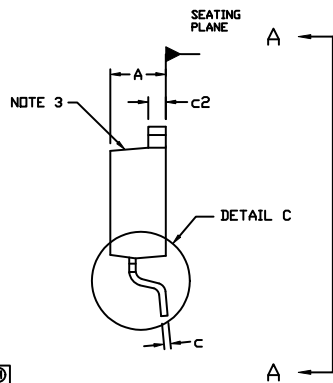

OPTIONAL CONSTRUCTIONS

GENERIC MARKING DIAGRAMS*

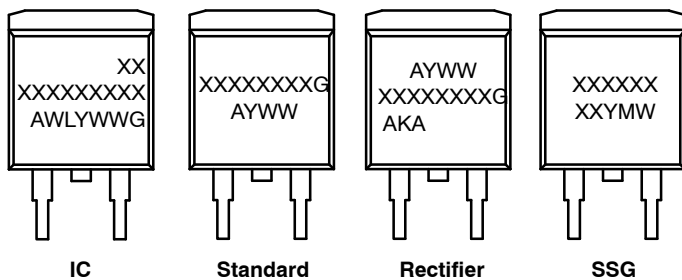

IC

Standard

Rectifier

SSG

- XXXXXX = Specific Device Code
- A = Assembly Location
- WL = Wafer Lot
- Y = Year
- WW = Work Week
- W = Week Code (SSG)
- M = Month Code (SSG)
- G = Pb-Free Package
- AKA = Polarity Indicator

*This information is generic. Please refer to device data sheet for actual part marking. Pb-Free indicator, "G" or microdot "▪", may or may not be present. Some products may not follow the Generic Marking.

| | | |
|------------------|---------------------------------------|--|
| DOCUMENT NUMBER: | 98AON56370E | Electronic versions are uncontrolled except when accessed directly from the Document Repository. Printed versions are uncontrolled except when stamped "CONTROLLED COPY" in red. |
| DESCRIPTION: | D ² PAK-3 (TO-263, 3-LEAD) | PAGE 1 OF 1 |

ON Semiconductor and ON are trademarks of Semiconductor Components Industries, LLC dba ON Semiconductor or its subsidiaries in the United States and/or other countries. ON Semiconductor reserves the right to make changes without further notice to any products herein. ON Semiconductor makes no warranty, representation or guarantee regarding the suitability of its products for any particular purpose, nor does ON Semiconductor assume any liability arising out of the application or use of any product or circuit, and specifically disclaims any and all liability, including without limitation special, consequential or incidental damages. ON Semiconductor does not convey any license under its patent rights nor the rights of others.

MECHANICAL CASE OUTLINE

PACKAGE DIMENSIONS

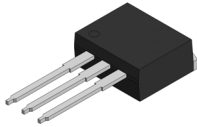

I2PAK (TO-262 3 LD)
CASE 418AV
ISSUE A

DATE 30 AUG 2022

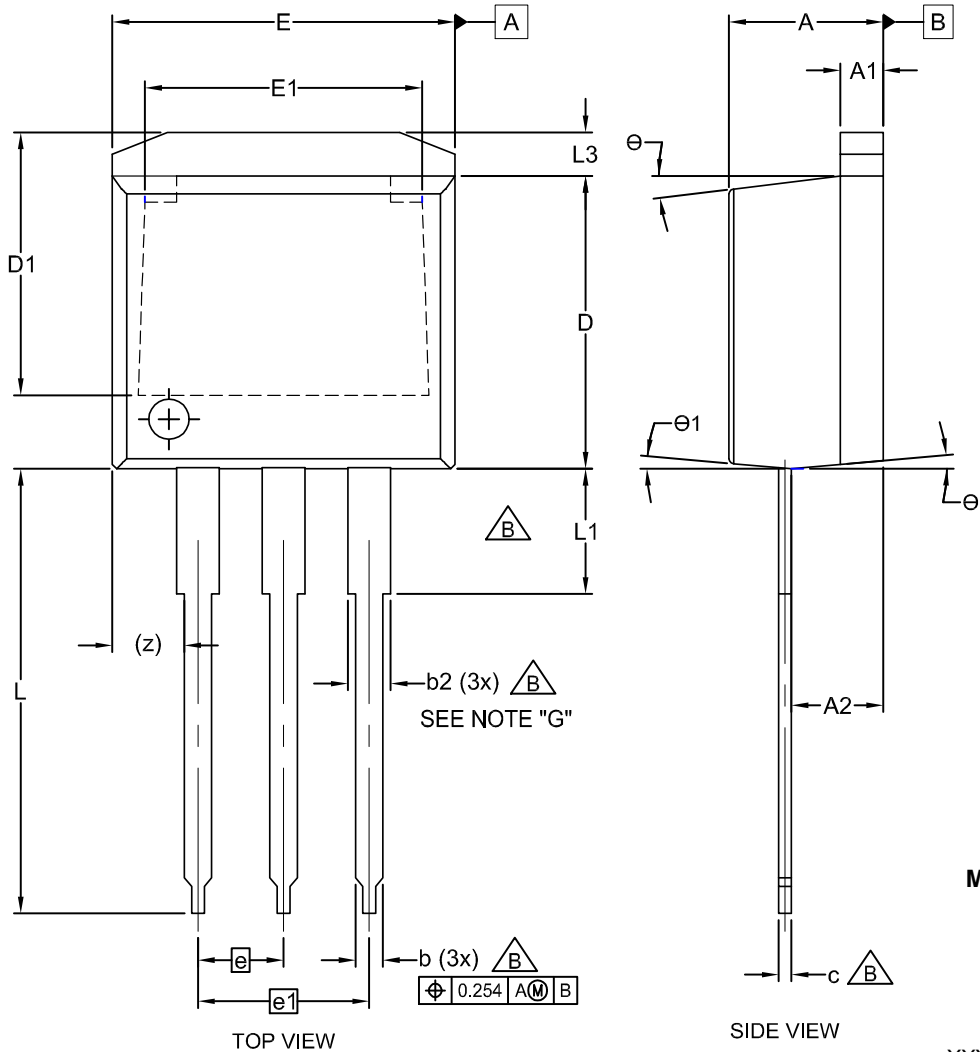

| DIM | MILLIMETERS | | |
|-----|-------------|-------|-------|
| | MIN | NOM | MAX |
| A | 4.06 | 4.45 | 4.83 |
| A1 | 1.14 | 1.27 | 1.40 |
| A2 | 2.03 | 2.41 | 2.79 |
| b | 0.64 | 0.77 | 0.90 |
| b2 | 1.14 | 1.46 | 1.78 |
| c | 0.33 | 0.49 | 0.64 |
| D | 8.64 | 9.15 | 9.65 |
| D1 | 6.86 | 7.37 | 7.88 |
| E | 9.65 | 9.97 | 10.29 |
| E1 | 6.22 | 7.28 | 8.33 |
| e | 2.54 BSC | | |
| e1 | 5.08 BSC | | |
| L | 12.70 | 13.72 | 14.73 |
| L1 | 2.80 | 3.38 | 3.96 |
| L3 | 1.00 | 1.20 | 1.40 |
| z | 2.13 REF | | |
| θ | 0° | -- | 7° |
| θ1 | 0° | -- | 5° |

GENERIC MARKING DIAGRAM*

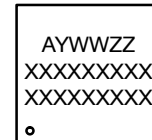

XXXX = Specific Device Code
 A = Assembly Location
 Y = Year
 WW = Work Week
 ZZ = Assembly Lot Code

*This information is generic. Please refer to device data sheet for actual part marking. Pb-Free indicator, "G" or microdot "•", may or may not be present. Some products may not follow the Generic Marking.

NOTES:

- A. EXCEPT WHERE NOTED CONFORMS TO TO262 JEDEC VARIATION AA.
- B. DOES NOT COMPLY JEDEC STD. VALUE.
- C. ALL DIMENSIONS ARE IN MILLIMETERS.
- D. DIMENSIONS ARE EXCLUSIVE OF BURRS, MOLD FLASH AND TIE BAR PROTRUSIONS.
- E. DIMENSION AND TOLERANCE AS PER ANSI Y14.5-1994.
- F. LOCATION OF PIN HOLE MAY VARY (LOWER LEFT CORNER, LOWER CENTER AND CENTER OF PACKAGE)
- G. MAXIMUM WIDTH FOR F102 DEVICE = 1.35 MAX.

| | | |
|-------------------------|----------------------------|--|
| DOCUMENT NUMBER: | 98AON13814G | Electronic versions are uncontrolled except when accessed directly from the Document Repository. Printed versions are uncontrolled except when stamped "CONTROLLED COPY" in red. |
| DESCRIPTION: | I2PAK (TO-262 3 LD) | PAGE 1 OF 1 |

onsemi and ONSEMI are trademarks of Semiconductor Components Industries, LLC dba onsemi or its subsidiaries in the United States and/or other countries. onsemi reserves the right to make changes without further notice to any products herein. onsemi makes no warranty, representation or guarantee regarding the suitability of its products for any particular purpose, nor does onsemi assume any liability arising out of the application or use of any product or circuit, and specifically disclaims any and all liability, including without limitation special, consequential or incidental damages. onsemi does not convey any license under its patent rights nor the rights of others.

onsemi, **Onsemi**, and other names, marks, and brands are registered and/or common law trademarks of Semiconductor Components Industries, LLC dba "**onsemi**" or its affiliates and/or subsidiaries in the United States and/or other countries. **onsemi** owns the rights to a number of patents, trademarks, copyrights, trade secrets, and other intellectual property. A listing of **onsemi**'s product/patent coverage may be accessed at www.onsemi.com/site/pdf/Patent-Marking.pdf. **onsemi** reserves the right to make changes at any time to any products or information herein, without notice. The information herein is provided "as-is" and **onsemi** makes no warranty, representation or guarantee regarding the accuracy of the information, product features, availability, functionality, or suitability of its products for any particular purpose, nor does **onsemi** assume any liability arising out of the application or use of any product or circuit, and specifically disclaims any and all liability, including without limitation special, consequential or incidental damages. Buyer is responsible for its products and applications using **onsemi** products, including compliance with all laws, regulations and safety requirements or standards, regardless of any support or applications information provided by **onsemi**. "Typical" parameters which may be provided in **onsemi** data sheets and/or specifications can and do vary in different applications and actual performance may vary over time. All operating parameters, including "Typicals" must be validated for each customer application by customer's technical experts. **onsemi** does not convey any license under any of its intellectual property rights nor the rights of others. **onsemi** products are not designed, intended, or authorized for use as a critical component in life support systems or any FDA Class 3 medical devices or medical devices with a same or similar classification in a foreign jurisdiction or any devices intended for implantation in the human body. Should Buyer purchase or use **onsemi** products for any such unintended or unauthorized application, Buyer shall indemnify and hold **onsemi** and its officers, employees, subsidiaries, affiliates, and distributors harmless against all claims, costs, damages, and expenses, and reasonable attorney fees arising out of, directly or indirectly, any claim of personal injury or death associated with such unintended or unauthorized use, even if such claim alleges that **onsemi** was negligent regarding the design or manufacture of the part. **onsemi** is an Equal Opportunity/Affirmative Action Employer. This literature is subject to all applicable copyright laws and is not for resale in any manner.

ADDITIONAL INFORMATION

TECHNICAL PUBLICATIONS:

Technical Library: www.onsemi.com/design/resources/technical-documentation
onsemi Website: www.onsemi.com

ONLINE SUPPORT: www.onsemi.com/support

For additional information, please contact your local Sales Representative at www.onsemi.com/support/sales