

Silicon Carbide Schottky Diode

650 V, 8 A

FFSM0865A

Description

Silicon Carbide (SiC) Schottky Diodes use a completely new technology that provides superior switching performance and higher reliability compared to Silicon. No reverse recovery current, temperature independent switching characteristics, and excellent thermal performance sets Silicon Carbide as the next generation of power semiconductor. System benefits include highest efficiency, faster operating frequency, increased power density, reduced EMI, and reduced system size and cost.

Features

- Max Junction Temperature 175°C
- Avalanche Rated 37 mJ
- High Surge Current Capacity
- Positive Temperature Coefficient
- Ease of Paralleling
- No Reverse Recovery/No Forward Recovery
- This Device is Pb-Free, Halogen Free/BFR Free and RoHS Compliant

Applications

- General Purpose
- SMPS, Solar Inverter, UPS
- Power Switching Circuits



ON Semiconductor®

www.onsemi.com

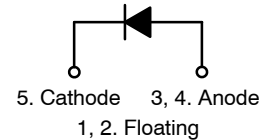

Schottky Diode

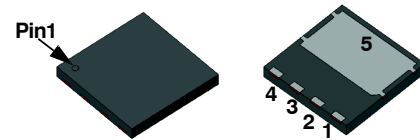

PQFN 8x8, 2P
CASE 483AP

MARKING DIAGRAM

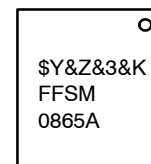

| | |
|-----------|-------------------------|
| \$Y | = ON Semiconductor Logo |
| &Z | = Assembly Plant Code |
| &3 | = Numeric Date Code |
| &K | = Lot Code |
| FFSM0865A | = Specific Device Code |

ORDERING INFORMATION

See detailed ordering and shipping information on page 2 of this data sheet.

FFSM0865A

ABSOLUTE MAXIMUM RATINGS (T_C = 25°C unless otherwise noted)

| Symbol | Parameter | Value | Unit | |
|-----------------------------------|---|--|------|---|
| V _{RRM} | Peak Repetitive Reverse Voltage | 650 | V | |
| E _{AS} | Single Pulse Avalanche Energy (Note 1) | 37 | mJ | |
| I _F | Continuous Rectified Forward Current @ T _C < 145°C | 8 | A | |
| | Continuous Rectified Forward Current @ T _C < 135°C | 9.6 | | |
| I _{F, Max} | Non-Repetitive Peak Forward Surge Current | T _C = 25°C, 10 μs | 550 | A |
| | | T _C = 150°C, 10 μs | 520 | A |
| I _{F, SM} | Non-Repetitive Forward Surge Current | Half-Sine Pulse, t _p = 8.3 ms | 49 | A |
| I _{F, RM} | Repetitive Forward Surge Current | Half-Sine Pulse, t _p = 8.3 ms | 25 | A |
| P _{tot} | Power Dissipation | T _C = 25°C | 64 | W |
| | | T _C = 150°C | 11 | W |
| T _J , T _{STG} | Operating and Storage Temperature Range | -55 to +175 | °C | |

Stresses exceeding those listed in the Maximum Ratings table may damage the device. If any of these limits are exceeded, device functionality should not be assumed, damage may occur and reliability may be affected.

1. E_{AS} of 37 mJ is based on starting T_J = 25°C, L = 1 mH, I_{AS} = 8.7 A, V = 50 V.

THERMAL CHARACTERISTICS

| Symbol | Parameter | Value | Unit |
|------------------|---|-------|------|
| R _{θJC} | Thermal Resistance, Junction to Case, Max | 2.35 | °C/W |

ELECTRICAL CHARACTERISTICS (T_C = 25°C unless otherwise noted)

| Symbol | Parameter | Test Condition | Min | Typ | Max | Unit |
|----------------|-------------------------|--|-----|------|------|------|
| V _F | Forward Voltage | I _F = 8 A, T _C = 25°C | - | 1.50 | 1.75 | V |
| | | I _F = 8 A, T _C = 125°C | - | 1.6 | 2.0 | |
| | | I _F = 8 A, T _C = 175°C | - | 1.72 | 2.4 | |
| I _R | Reverse Current | V _R = 650 V, T _C = 25°C | - | - | 200 | μA |
| | | V _R = 650 V, T _C = 125°C | - | - | 400 | |
| | | V _R = 650 V, T _C = 175°C | - | - | 600 | |
| Q _C | Total Capacitive Charge | V = 400 V | - | 27 | - | nC |
| C | Total Capacitance | V _R = 1 V, f = 100 kHz | - | 463 | - | pF |
| | | V _R = 200 V, f = 100 kHz | - | 48 | - | |
| | | V _R = 400 V, f = 100 kHz | - | 38 | - | |

Product parametric performance is indicated in the Electrical Characteristics for the listed test conditions, unless otherwise noted. Product performance may not be indicated by the Electrical Characteristics if operated under different conditions.

PACKAGE MARKING AND ORDERING INFORMATION

| Part Number | Top Marking | Package | Shipping [†] |
|-------------|-------------|--------------------------------|--------------------------|
| FFSM0865A | FFSM0865A | PQFN 8x8, 2P (Halogen Free) | 3000 Units / Tape & Reel |

[†]For information on tape and reel specifications, including part orientation and tape sizes, please refer to our Tape and Reel Packaging Specifications Brochure, BRD8011/D.

TYPICAL CHARACTERISTICS

($T_J = 25^\circ\text{C}$ unless otherwise noted)

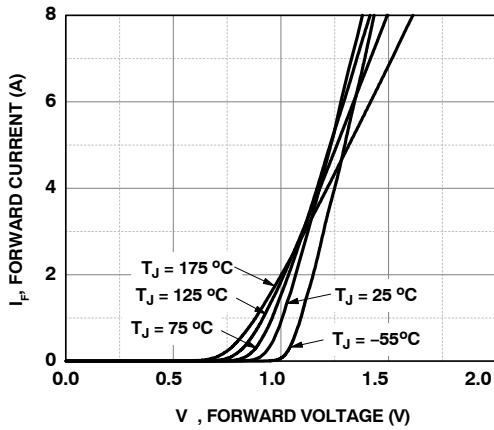

Figure 1. Forward Characteristics

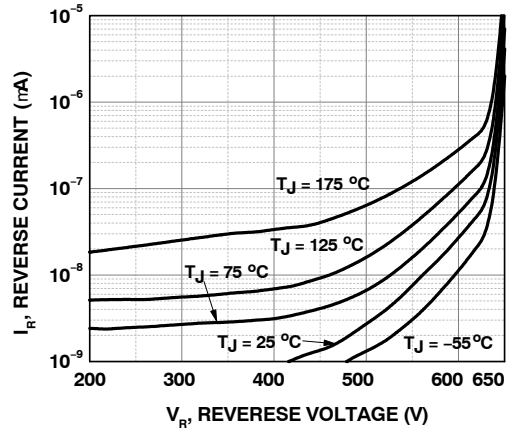

Figure 2. Reverse Characteristics

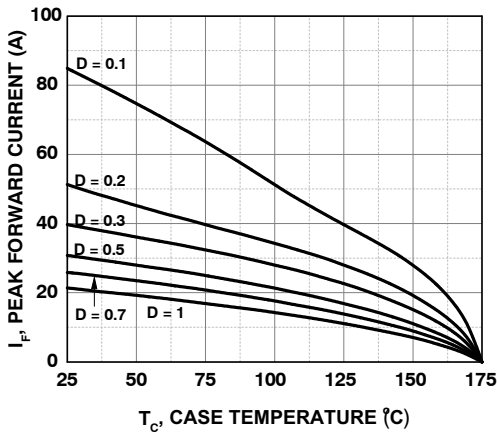

Figure 3. Current Derating

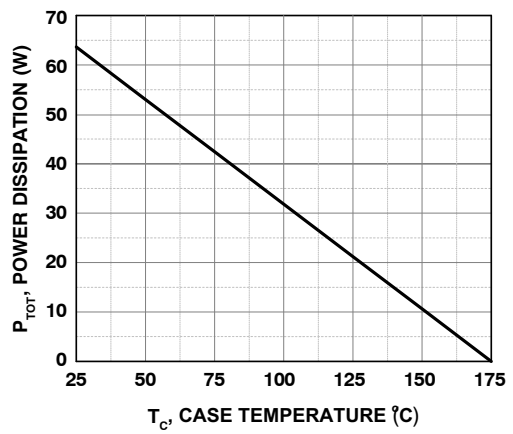

Figure 4. Power Derating

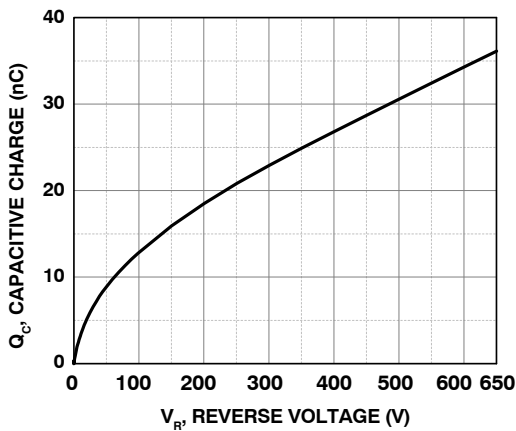

Figure 5. Capacitive Charge vs. Reverse Voltage

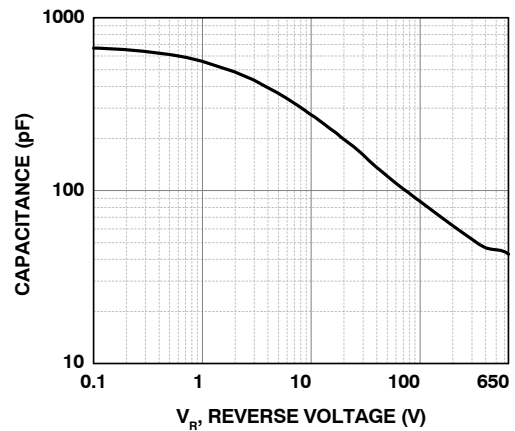

Figure 6. Capacitance vs. Reverse Voltage

FFSM0865A

TYPICAL CHARACTERISTICS

($T_J = 25^\circ\text{C}$ unless otherwise noted)

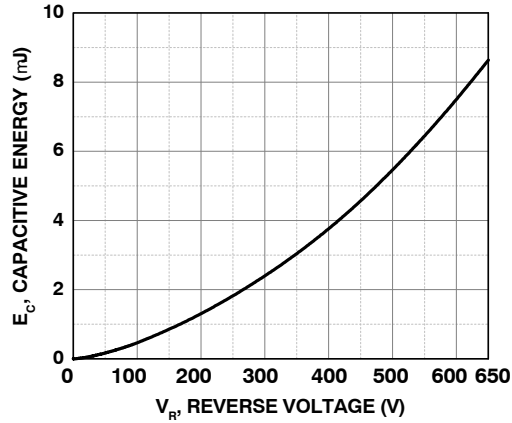

Figure 7. Capacitance Stored Energy

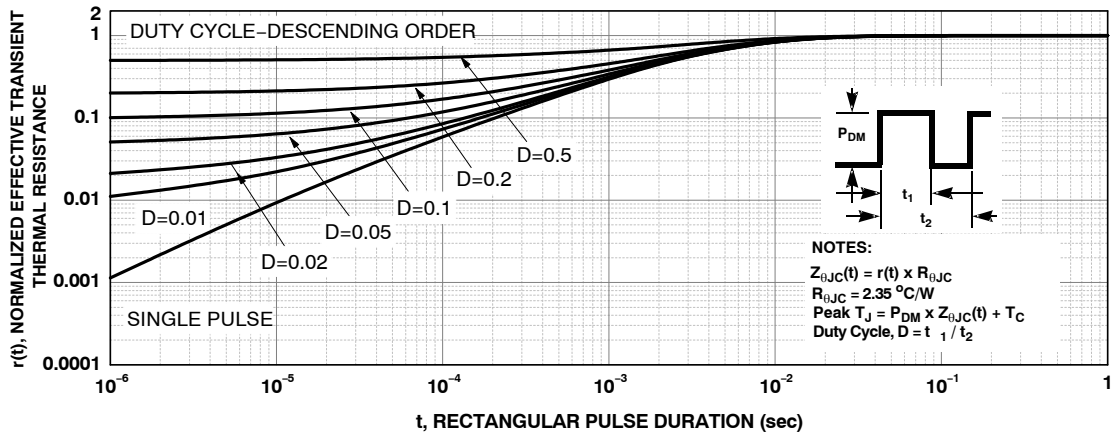

Figure 8. Junction-to-Case Transient Thermal Response Curve

TEST CIRCUIT AND WAVEFORMS

$L = 1 \text{ mH}$
 $R < 0.1 \Omega$
 $V_{DD} = 50 \text{ V}$
 $E_{AVL} = 1/2LI^2 [V_{R(AVL)} / (V_{R(AVL)} - V_{DD})]$
 $Q1 = \text{IGBT} (BV_{CES} > \text{DUT } V_{R(AVL)})$

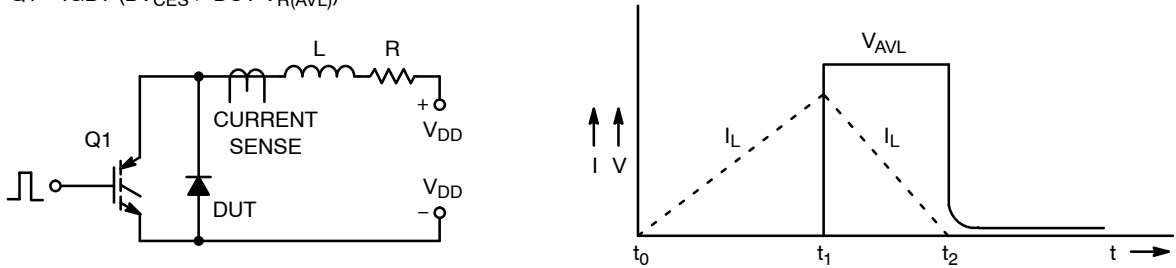
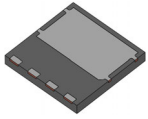

Figure 9. Unclamped Inductive Switching Test Circuit & Waveform

MECHANICAL CASE OUTLINE

PACKAGE DIMENSIONS

ON Semiconductor®



PQFN4 8X8, 2P
CASE 483AP
ISSUE A

DATE 06 JUL 2021

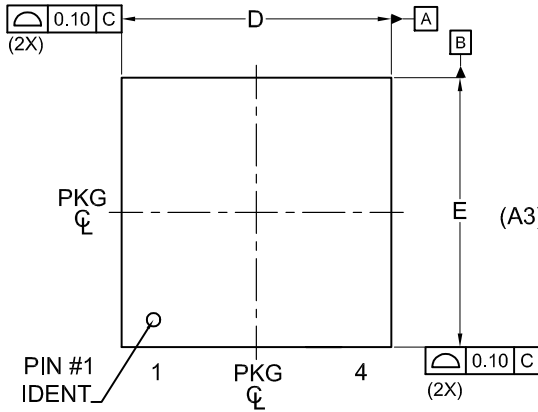

NOTES:

1. DIMENSIONING AND TOLERANCING PER ASME Y14.5M, 2009.
2. CONTROLLING DIMENSION: MILLIMETERS
3. COPLANARITY APPLIES TO THE EXPOSED PADS AS WELL AS THE TERMINALS.
4. DIMENSIONS D1 AND E1 DO NOT INCLUDE MOLD FLASH, PROTRUSIONS, OR GATE BURRS.
5. SEATING PLANE IS DEFINED BY THE TERMINALS. "A1" IS DEFINED AS THE DISTANCE FROM THE SEATING PLANE TO THE LOWEST POINT ON THE PACKAGE BODY.
6. IT IS RECOMMENDED TO HAVE NO TRACES OR VIAS WITHIN THE KEEP OUT AREA.

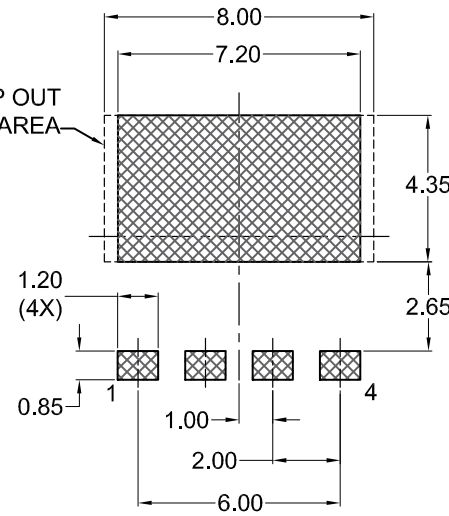
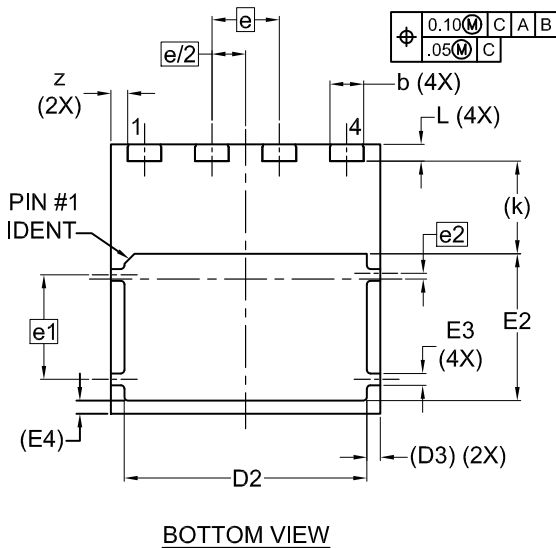
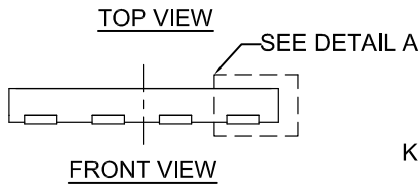
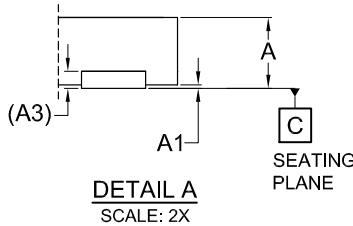

| DIM | MILLIMETERS | | |
|-----|-------------|------|------|
| | MIN. | NOM. | MAX. |
| A | 0.90 | 1.00 | 1.10 |
| A1 | 0.00 | - | 0.05 |
| A3 | 0.20 REF | | |
| b | 0.90 | 1.00 | 1.10 |
| D | 7.90 | 8.00 | 8.10 |
| D2 | 7.10 | 7.20 | 7.30 |
| D3 | 0.40 REF | | |
| E | 7.90 | 8.00 | 8.10 |
| E2 | 4.25 | 4.35 | 4.45 |
| E3 | 0.25 | 0.35 | 0.45 |
| E4 | 0.40 REF | | |
| e | 2.00 BSC | | |
| e/2 | 1.00 BSC | | |
| e1 | 3.10 BSC | | |
| e2 | 0.17 BSC | | |
| k | 2.75 REF | | |
| L | 0.40 | 0.50 | 0.60 |

LAND PATTERN RECOMMENDATION

*FOR ADDITIONAL INFORMATION ON OUR PB-FREE STRATEGY AND SOLDERING DETAILS, PLEASE DOWNLOAD THE ON SEMICONDUCTOR SOLDERING AND MOUNTING TECHNIQUES REFERENCE MANUAL, SOLDERRM/D.

| | | |
|-------------------------|----------------------|--|
| DOCUMENT NUMBER: | 98AON13664G | Electronic versions are uncontrolled except when accessed directly from the Document Repository. Printed versions are uncontrolled except when stamped "CONTROLLED COPY" in red. |
| DESCRIPTION: | PQFN4 8X8, 2P | PAGE 1 OF 1 |

ON Semiconductor and ON are trademarks of Semiconductor Components Industries, LLC dba ON Semiconductor or its subsidiaries in the United States and/or other countries. ON Semiconductor reserves the right to make changes without further notice to any products herein. ON Semiconductor makes no warranty, representation or guarantee regarding the suitability of its products for any particular purpose, nor does ON Semiconductor assume any liability arising out of the application or use of any product or circuit, and specifically disclaims any and all liability, including without limitation special, consequential or incidental damages. ON Semiconductor does not convey any license under its patent rights nor the rights of others.

onsemi, **Onsemi**, and other names, marks, and brands are registered and/or common law trademarks of Semiconductor Components Industries, LLC dba "**onsemi**" or its affiliates and/or subsidiaries in the United States and/or other countries. **onsemi** owns the rights to a number of patents, trademarks, copyrights, trade secrets, and other intellectual property. A listing of **onsemi**'s product/patent coverage may be accessed at www.onsemi.com/site/pdf/Patent-Marking.pdf. **onsemi** reserves the right to make changes at any time to any products or information herein, without notice. The information herein is provided "as-is" and **onsemi** makes no warranty, representation or guarantee regarding the accuracy of the information, product features, availability, functionality, or suitability of its products for any particular purpose, nor does **onsemi** assume any liability arising out of the application or use of any product or circuit, and specifically disclaims any and all liability, including without limitation special, consequential or incidental damages. Buyer is responsible for its products and applications using **onsemi** products, including compliance with all laws, regulations and safety requirements or standards, regardless of any support or applications information provided by **onsemi**. "Typical" parameters which may be provided in **onsemi** data sheets and/or specifications can and do vary in different applications and actual performance may vary over time. All operating parameters, including "Typicals" must be validated for each customer application by customer's technical experts. **onsemi** does not convey any license under any of its intellectual property rights nor the rights of others. **onsemi** products are not designed, intended, or authorized for use as a critical component in life support systems or any FDA Class 3 medical devices or medical devices with a same or similar classification in a foreign jurisdiction or any devices intended for implantation in the human body. Should Buyer purchase or use **onsemi** products for any such unintended or unauthorized application, Buyer shall indemnify and hold **onsemi** and its officers, employees, subsidiaries, affiliates, and distributors harmless against all claims, costs, damages, and expenses, and reasonable attorney fees arising out of, directly or indirectly, any claim of personal injury or death associated with such unintended or unauthorized use, even if such claim alleges that **onsemi** was negligent regarding the design or manufacture of the part. **onsemi** is an Equal Opportunity/Affirmative Action Employer. This literature is subject to all applicable copyright laws and is not for resale in any manner.

PUBLICATION ORDERING INFORMATION

LITERATURE FULFILLMENT:

Email Requests to: orderlit@onsemi.com

onsemi Website: www.onsemi.com

TECHNICAL SUPPORT

North American Technical Support:
Voice Mail: 1 800-282-9855 Toll Free USA/Canada
Phone: 011 421 33 790 2910

Europe, Middle East and Africa Technical Support:

Phone: 00421 33 790 2910

For additional information, please contact your local Sales Representative