

MOSFET – Power, Dual P-Channel

-40 V, -20 A, 12.5 mΩ

FDWS9520L-F085

Features

- Small Footprint (5x6 mm) for Compact Design
- Low $R_{DS(on)}$ to Minimize Conduction Losses
- Low QG and Capacitance to Minimize Driver Losses
- Wettable Flanks for Enhanced Optical Inspection
- AEC-Q101 Qualified and PPAP Capable
- These Devices are Pb-Free, Halogen Free/BFR Free and are RoHS Compliant

MAXIMUM RATINGS ($T_J = 25^\circ\text{C}$ unless otherwise noted)

Parameter		Symbol	Value	Unit
Drain-to-Source Voltage		V_{DS}	-40	V
Gate-to-Source Voltage		V_{GS}	± 16	V
Continuous Drain Current $R_{\theta JC}$ (Notes 1, 3)	Steady State	$T_C = 25^\circ\text{C}$	-60.8	A
		$T_C = 100^\circ\text{C}$	-43.0	
Power Dissipation $R_{\theta JC}$ (Note 1)	Steady State	$T_C = 25^\circ\text{C}$	75	W
		$T_C = 100^\circ\text{C}$	37.5	
Continuous Drain Current $R_{\theta JA}$ (Notes 1, 2, 3)	Steady State	$T_C = 25^\circ\text{C}$	-12.2	A
		$T_C = 100^\circ\text{C}$	-8.6	
Power Dissipation $R_{\theta JA}$ (Notes 1 & 2)	Steady State	$T_C = 25^\circ\text{C}$	3.0	W
		$T_C = 100^\circ\text{C}$	1.5	
Pulsed Drain Current	$T_C = 25^\circ\text{C}, t_p = 10 \mu\text{s}$	I_{DM}	-281	A
Operating Junction and Storage Temperature		T_J, T_{stg}	-55 to +175	$^\circ\text{C}$
Source Current (Body Diode)		I_S	-20	A
Single Pulse Drain-to-Source Avalanche Energy ($I_L(pk) = -19$)		EAS	90	mJ
Lead Temperature for Soldering Purposes (1/83 from case for 10 s)		T_L	260	$^\circ\text{C}$

Stresses exceeding those listed in the Maximum Ratings table may damage the device. If any of these limits are exceeded, device functionality should not be assumed, damage may occur and reliability may be affected.

THERMAL RESISTANCE MAXIMUM RATINGS

Parameter	Symbol	Value	Unit
Junction-to-Case – Steady State	$R_{\theta JC}$	2	$^\circ\text{C}/\text{W}$
Junction-to-Ambient – Steady State (Note 2)	$R_{\theta JA}$	50	$^\circ\text{C}/\text{W}$

1. The entire application environment impacts the thermal resistance values shown, they are not constants and are only valid for the particular conditions noted.
2. Surface-mounted on FR4 board using a 650 mm², 2 oz. Cu pad.
3. Maximum current for pulses as long as 1 second is higher but is dependent on pulse duration and duty cycle.

$V_{(BR)DSS}$	$R_{DS(ON)} \text{ MAX}$	$I_D \text{ MAX}$
-40 V	12.5 mΩ @ -10 V	-20 A
	19.5 mΩ @ -4.5 V	

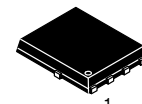
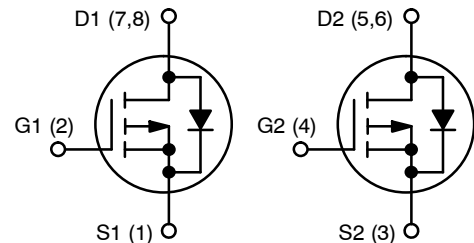

1
PQFN8 5x6, 1.27P
CASE 483BL

ORDERING INFORMATION

See detailed ordering, marking and shipping information on page 3 of this data sheet.

FDWS9520L–F085

ELECTRICAL CHARACTERISTICS ($T_J = 25^\circ\text{C}$ unless otherwise noted)

Parameter	Symbol	Test Condition	Min	Typ	Max	Unit
-----------	--------	----------------	-----	-----	-----	------

Off Characteristics

Drain to Source Breakdown Voltage	$V_{(BR)DSS}$	$V_{GS} = 0\text{ V}, I_D = -250\ \mu\text{A}$	-40			V	
Drain-to-Source Breakdown Voltage Temperature Coefficient	$V_{(BR)DSS}/T_J$			21		mV/ $^\circ\text{C}$	
Zero Gate Voltage Drain Current	I_{DSS}	$V_{GS} = 0\text{ V}, V_{DS} = -40\text{ V}$	$T_J = 25^\circ\text{C}$			-1	μA
			$T_J = 175^\circ\text{C}$			-1	mA
Zero Gate Voltage Drain Current	I_{GSS}	$V_{DS} = 0\text{ V}, V_{GS} = \pm 16\text{ V}$				± 100	nA

On Characteristics (Note 4)

Gate Threshold Voltage	$V_{GS(TH)}$	$V_{GS} = V_{DS}, I_D = -250\ \mu\text{A}$	-1	-1.8	-3	V
Threshold Temperature Coefficient	$V_{GS(TH)}/T_J$			-5.5		mV/ $^\circ\text{C}$
Drain-to-Source On Resistance	$R_{DS(on)}$	$V_{GS} = -10\text{ V}$	$I_D = -20\text{ A}$	10.4	12.5	m Ω
		$V_{GS} = -4.5\text{ V}$	$I_D = -10\text{ A}$	14.6	19.5	

Charges, Capacitances & Gate Resistance

Input Capacitance	C_{iss}	$V_{GS} = 0\text{ V}, f = 1\text{ MHz}, V_{DS} = -20\text{ V}$		2370		pF
Output Capacitance	C_{oss}			940		pF
Reverse Transfer Capacitance	C_{rss}			40		pF
Gate Resistance	R_g	$V_{GS} = 0.5\text{ V}, f = 1\text{ MHz}$		17		Ω
Total Gate Charge	$Q_{G(TOT)}$	$V_{GS} = -10\text{ V}, V_{DS} = -32\text{ V}; I_D = -20\text{ A}$		33		nC
		$V_{GS} = -4.5\text{ V}, V_{DS} = -32\text{ V}; I_D = -20\text{ A}$		13		
Threshold Gate Charge	$Q_{g(th)}$	$V_{GS} = 0\text{ to }-1\text{ V}$		2		
Gate to Source Gate Charge	Q_{gs}	$V_{DD} = -20\text{ V}, I_D = -20\text{ A}$		7		
Gate to Drain "Miller" Charge	Q_{gd}			4		
Plateau Voltage	V_{GP}			-4		V

Switching Characteristics

Turn-On Delay Time	$t_{d(ON)}$	$V_{DD} = -20\text{ V}, I_D = -20\text{ A}, V_{GS} = -10\text{ V}, R_{GEN} = 6\ \Omega$		8		ns
Turn-On Rise Time	t_r			21		ns
Turn-Off Delay Time	$t_{d(OFF)}$			120		ns
Turn-Off Fall Time	t_f			34		ns

Drain-Source Diode Characteristics

Source to Drain Diode Voltage	V_{SD}	$I_{SD} = -20\text{ A}, V_{GS} = 0\text{ V}$		-0.9	-1.25	V
		$I_{SD} = -10\text{ A}, V_{GS} = 0\text{ V}$		-0.83	-1.2	V
Reverse Recovery Time	T_{RR}	$V_{GS} = 0\text{ V}, dI_{SD}/dt = 100\text{ A}/\mu\text{s}, I_S = -20\text{ A}$		46		ns
Charge Time	t_a			22		
Discharge Time	t_b			24		
Reverse Recovery Charge	Q_{RR}			37		

Product parametric performance is indicated in the Electrical Characteristics for the listed test conditions, unless otherwise noted. Product performance may not be indicated by the Electrical Characteristics if operated under different conditions.

4. Pulse Test: pulse width $\leq 300\ \mu\text{s}$, duty cycle $\leq 2\%$

5. Switching characteristics are independent of operating junction temperatures.

FDWS9520L-F085

ORDERING INFORMATION

Device	Device Marking	Package	Shipping†
FDWS9520L-F085	FDWS9520L	PQFN8 5x6, 12.7P (Pb-Free, Halogen Free)	3,000 / Tape & Reel

†For information on tape and reel specifications, including part orientation and tape sizes, please refer to our Tape and Reel Packaging Specifications Brochure, BRD8011/D

TYPICAL CHARACTERISTICS

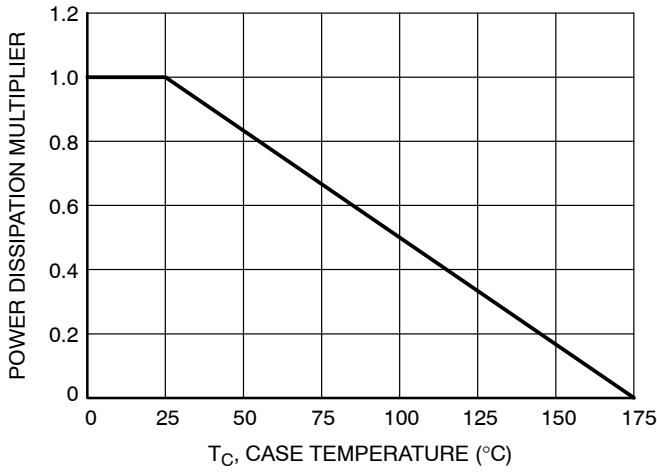

Figure 1. Normalized Power Dissipation vs. Case Temperature

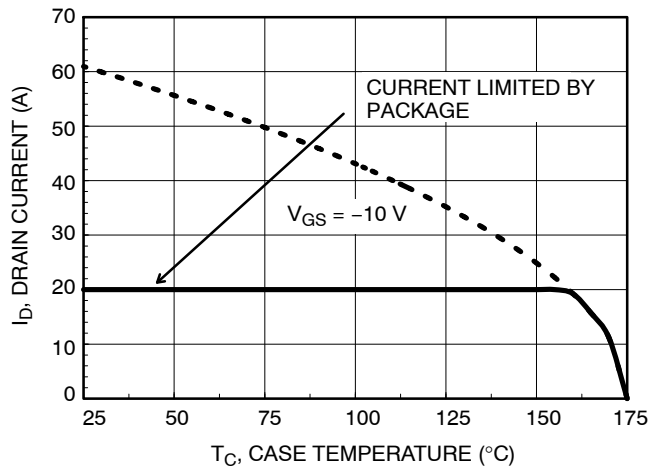

Figure 2. Maximum Continuous Drain Current vs. Case Temperature

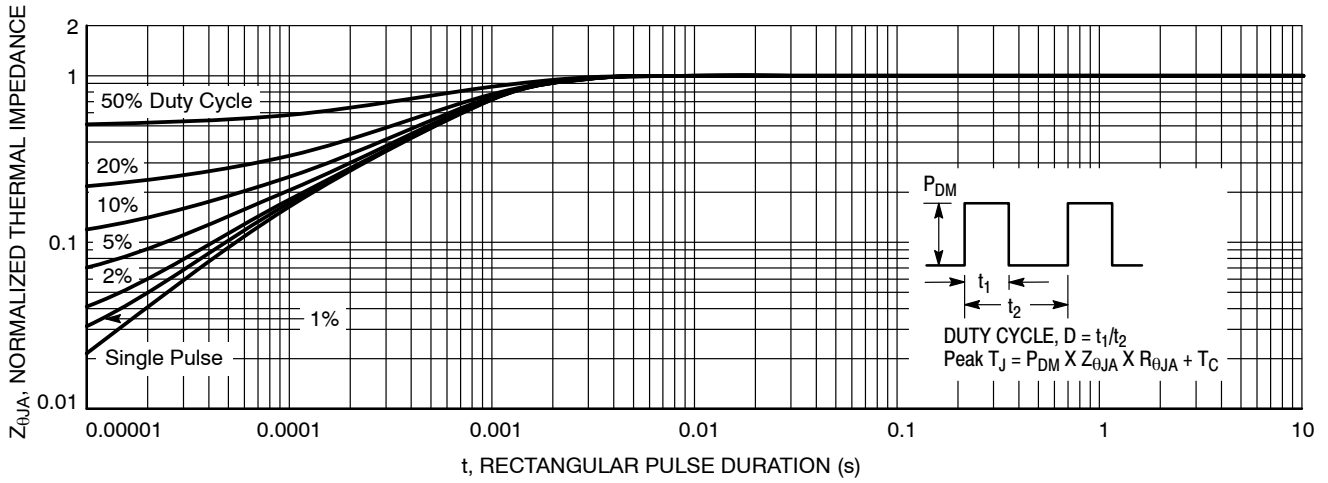

Figure 3. Normalized Maximum Transient Thermal Impedance

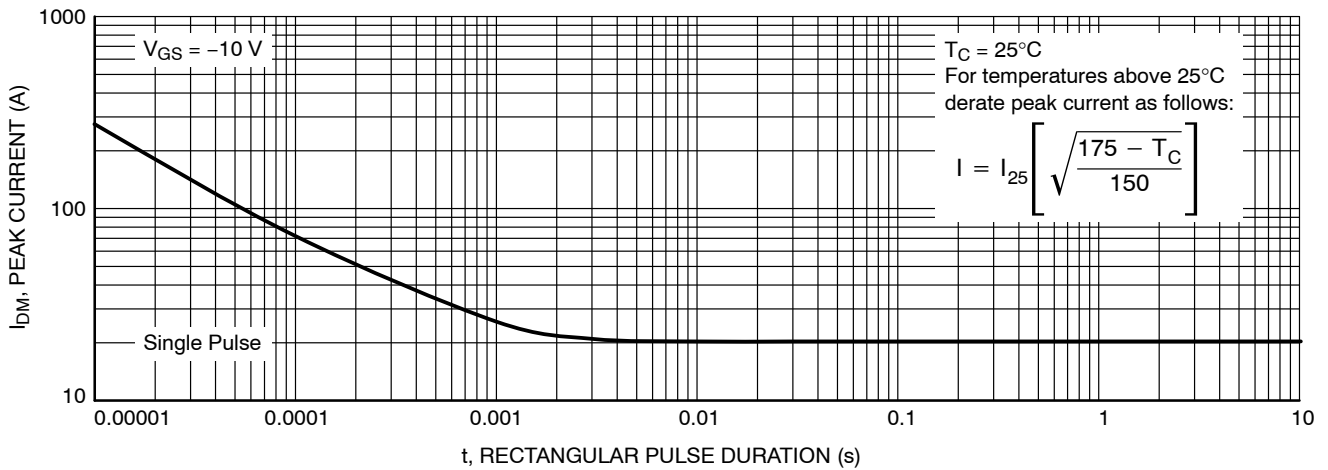

Figure 4. Peak Current Capability

TYPICAL CHARACTERISTICS

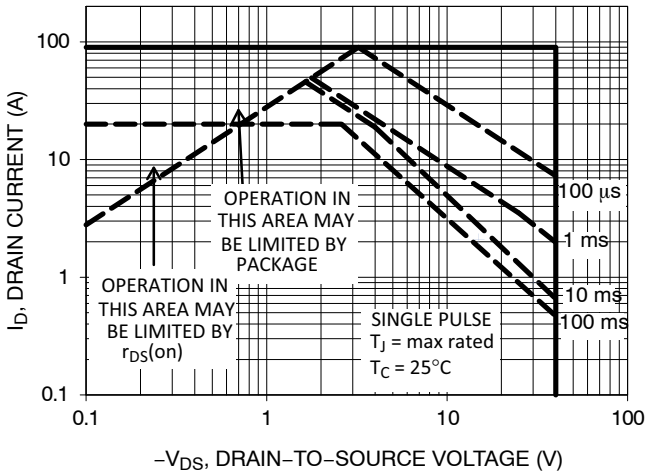

Figure 5. Forward Bias Safe Operating Area

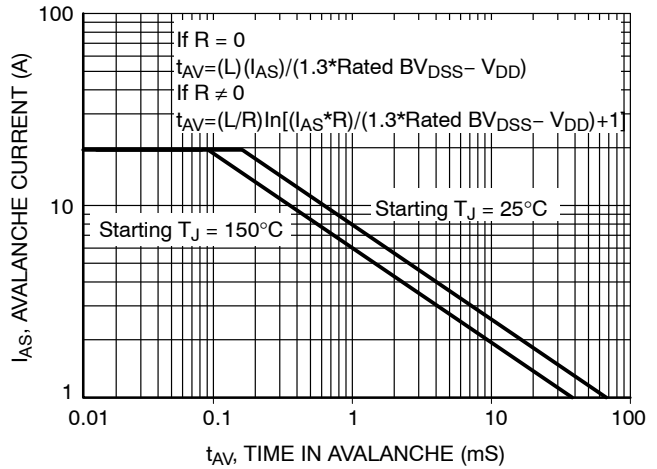

Figure 6. Unclamped Inductive Switching Capability

(Note: Refer to onsemi Applications Notes [AN7514](#) and [AN7515](#))

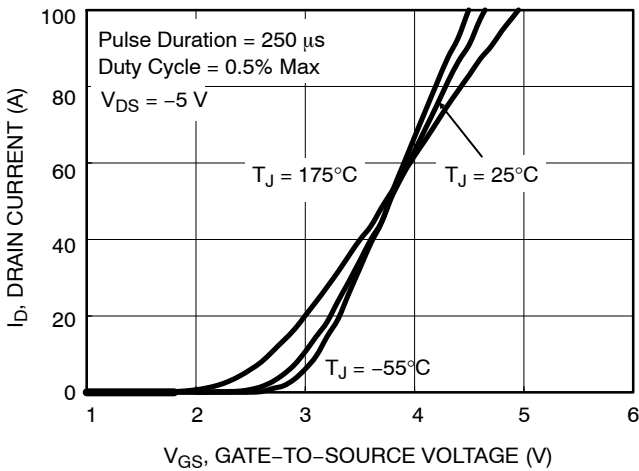

Figure 7. Transfer Characteristics

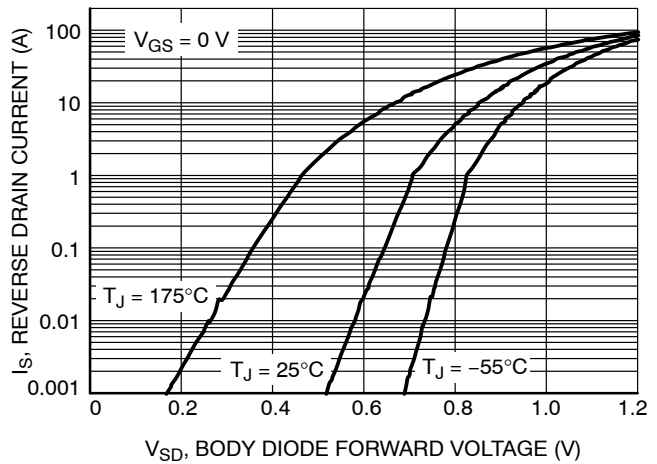

Figure 8. Forward Diode Characteristics

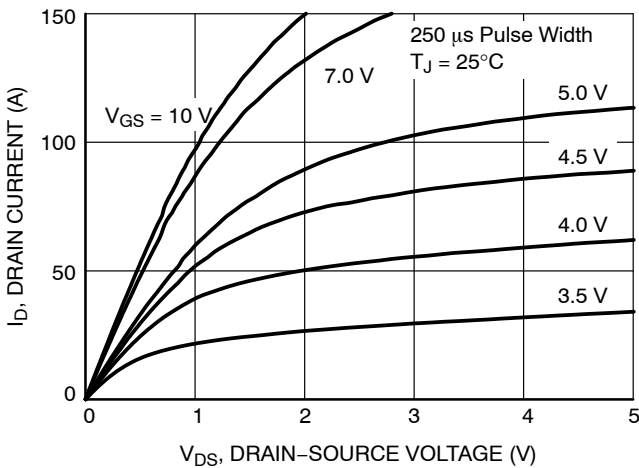

Figure 9. Saturation Characteristics

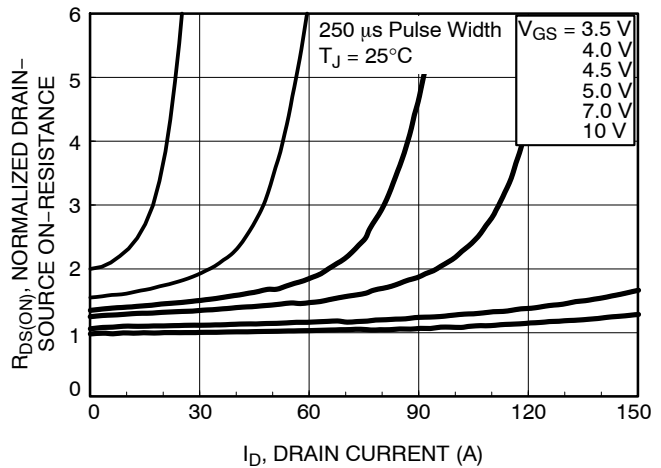

Figure 10. Normalized $R_{DS(ON)}$ vs. Drain Current

TYPICAL CHARACTERISTICS

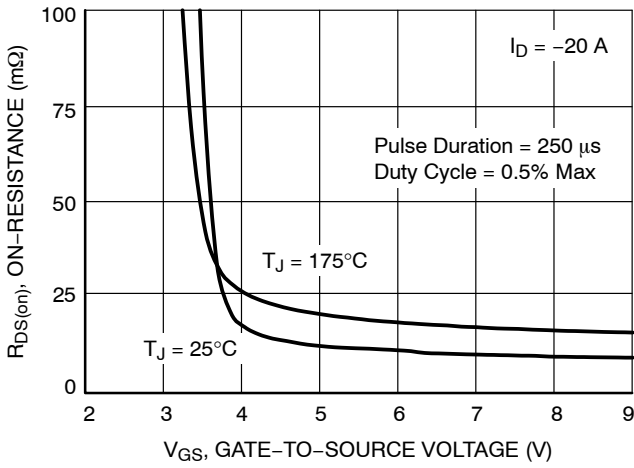

Figure 11. $R_{DS(on)}$ vs. Gate Voltage

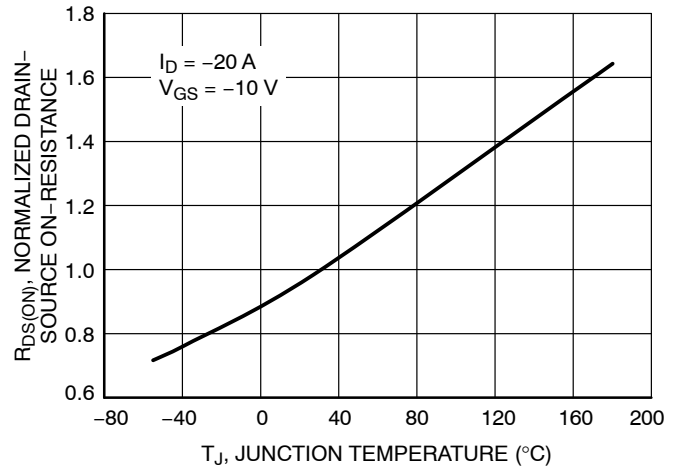

Figure 12. Normalized $R_{DS(on)}$ vs. Junction Temperature

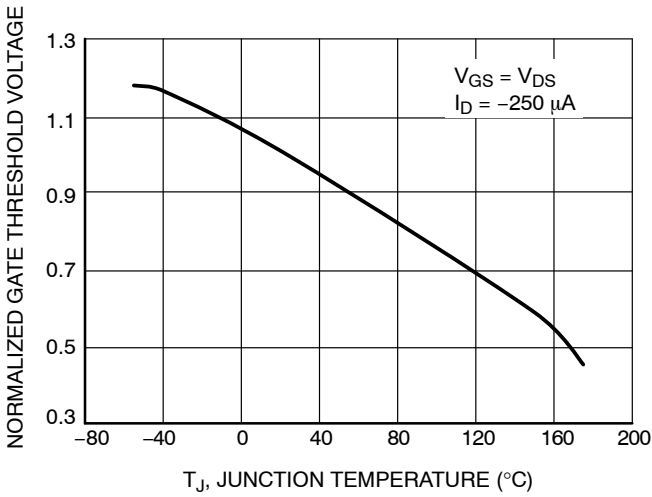

Figure 13. Normalized Gate Threshold Voltage vs. Temperature

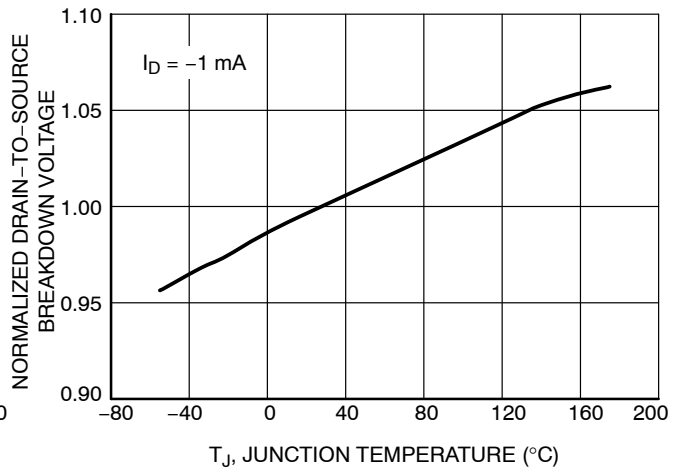

Figure 14. Normalized Drain-to-Source Breakdown Voltage vs. Junction Temperature

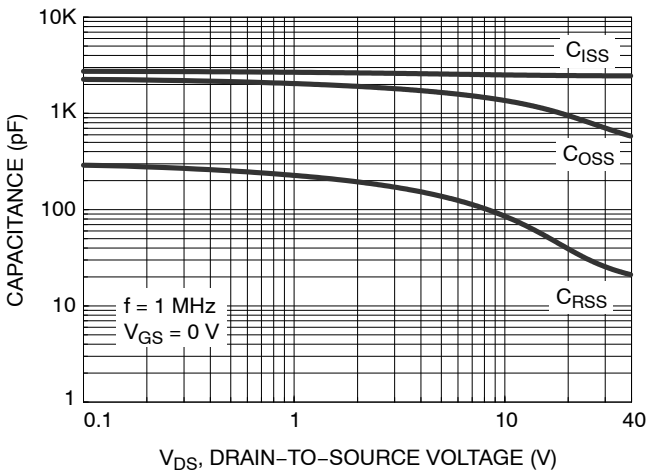

Figure 15. Capacitance vs. Drain-to-Source Voltage

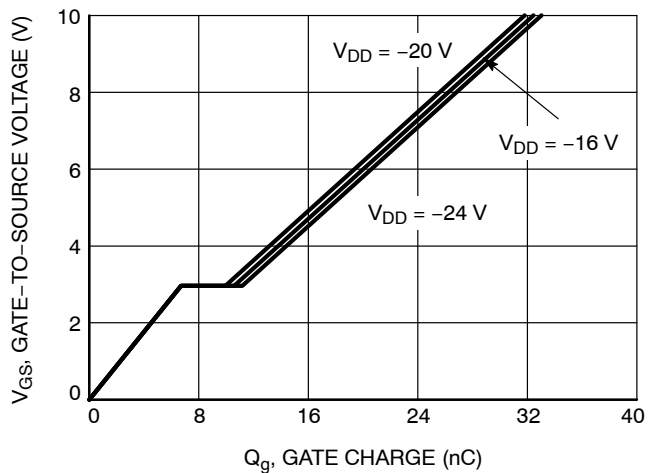

Figure 16. Gate Charge vs. Gate-to-Source Voltage

MECHANICAL CASE OUTLINE

PACKAGE DIMENSIONS

ON Semiconductor®



PQFN8 5X6, 1.27P

CASE 483BL

ISSUE A

DATE 23 APR 2021

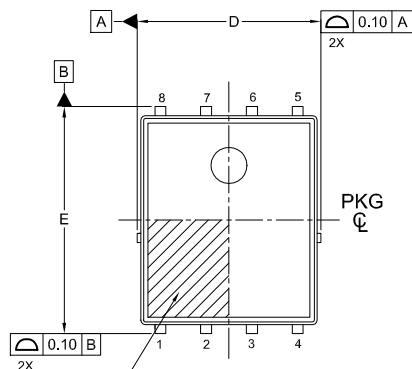
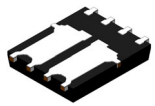

TOP VIEW

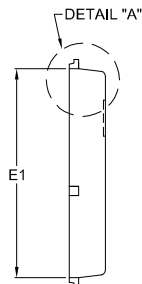

SIDE VIEW

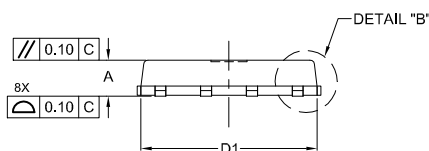

FRONT VIEW

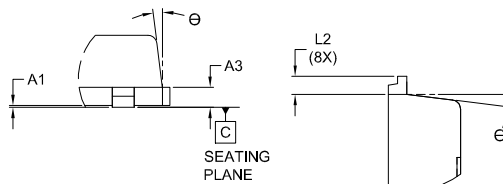

DETAIL "B"

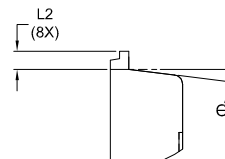

DETAIL "A"

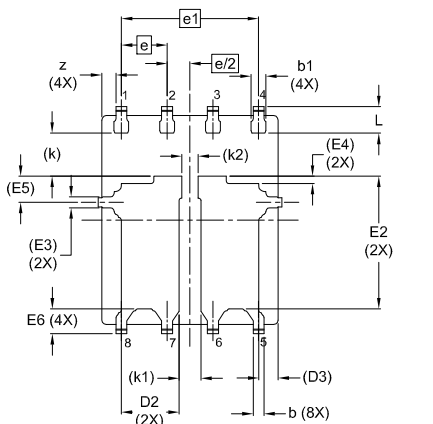

BOTTOM VIEW

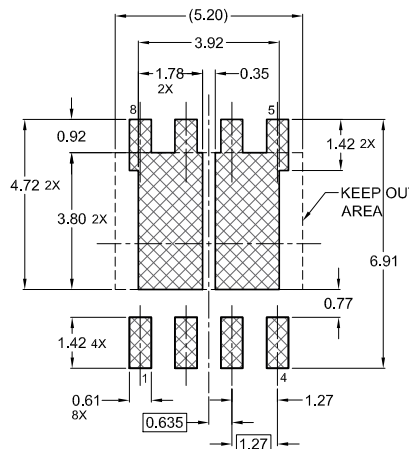

LAND PATTERN RECOMMENDATION

NOTES:

1. DIMENSIONING AND TOLERANCING PER ASME Y14.5M, 2009.
2. CONTROLLING DIMENSION: MILLIMETERS
3. COPLANARITY APPLIES TO THE EXPOSED PADS AS WELL AS THE TERMINALS.
4. DIMENSIONS D1 AND E1 DO NOT INCLUDE MOLD FLASH, PROTRUSIONS, OR GATE BURRS.
5. SEATING PLANE IS DEFINED BY THE TERMINALS. "A1" IS DEFINED AS THE DISTANCE FROM THE SEATING PLANE TO THE LOWEST POINT ON THE PACKAGE BODY.
6. IT IS RECOMMENDED TO HAVE NO TRACES OR VIAS WITHIN THE KEEP OUT AREA.

DIM	MILLIMETERS		
	MIN.	NOM.	MAX.
A	0.90	1.00	1.10
A1	0.00	-	0.05
A3	0.23	0.28	0.33
b	0.26	0.31	0.36
b1	0.36	0.41	0.46
D	5.00	5.10	5.20
D1	4.80	4.90	5.00
D2	1.51	1.61	1.71
D3	0.54 REF		
E	6.20	6.30	6.40
E1	5.70	5.80	5.90
E2	3.58	3.68	3.78
E3	0.30 REF		
E4	0.10	0.20	0.30
E5	0.72 REF		
E6	0.59	0.69	0.79
e	1.27 BSC		
e1	3.81 BSC		
e/2	0.635 BSC		
k	1.19 REF		
k1	0.60 REF		
k2	0.45 REF		
L	0.64	0.74	0.84
L2	0.15	0.25	0.35
z	0.39 REF		
θ	0°	-	7°

*FOR ADDITIONAL INFORMATION ON OUR PB-FREE STRATEGY AND SOLDERING DETAILS, PLEASE DOWNLOAD THE ON SEMICONDUCTOR SOLDERING AND MOUNTING TECHNIQUES REFERENCE MANUAL, SOLDERRM/D.

DOCUMENT NUMBER:	98AON13690G	Electronic versions are uncontrolled except when accessed directly from the Document Repository. Printed versions are uncontrolled except when stamped "CONTROLLED COPY" in red.
DESCRIPTION:	PQFN8 5X6, 1.27P	PAGE 1 OF 1

ON Semiconductor and ON are trademarks of Semiconductor Components Industries, LLC dba ON Semiconductor or its subsidiaries in the United States and/or other countries. ON Semiconductor reserves the right to make changes without further notice to any products herein. ON Semiconductor makes no warranty, representation or guarantee regarding the suitability of its products for any particular purpose, nor does ON Semiconductor assume any liability arising out of the application or use of any product or circuit, and specifically disclaims any and all liability, including without limitation special, consequential or incidental damages. ON Semiconductor does not convey any license under its patent rights nor the rights of others.

onsemi, **Onsemi**, and other names, marks, and brands are registered and/or common law trademarks of Semiconductor Components Industries, LLC dba "**onsemi**" or its affiliates and/or subsidiaries in the United States and/or other countries. **onsemi** owns the rights to a number of patents, trademarks, copyrights, trade secrets, and other intellectual property. A listing of **onsemi**'s product/patent coverage may be accessed at www.onsemi.com/site/pdf/Patent-Marking.pdf. **onsemi** reserves the right to make changes at any time to any products or information herein, without notice. The information herein is provided "as-is" and **onsemi** makes no warranty, representation or guarantee regarding the accuracy of the information, product features, availability, functionality, or suitability of its products for any particular purpose, nor does **onsemi** assume any liability arising out of the application or use of any product or circuit, and specifically disclaims any and all liability, including without limitation special, consequential or incidental damages. Buyer is responsible for its products and applications using **onsemi** products, including compliance with all laws, regulations and safety requirements or standards, regardless of any support or applications information provided by **onsemi**. "Typical" parameters which may be provided in **onsemi** data sheets and/or specifications can and do vary in different applications and actual performance may vary over time. All operating parameters, including "Typicals" must be validated for each customer application by customer's technical experts. **onsemi** does not convey any license under any of its intellectual property rights nor the rights of others. **onsemi** products are not designed, intended, or authorized for use as a critical component in life support systems or any FDA Class 3 medical devices or medical devices with a same or similar classification in a foreign jurisdiction or any devices intended for implantation in the human body. Should Buyer purchase or use **onsemi** products for any such unintended or unauthorized application, Buyer shall indemnify and hold **onsemi** and its officers, employees, subsidiaries, affiliates, and distributors harmless against all claims, costs, damages, and expenses, and reasonable attorney fees arising out of, directly or indirectly, any claim of personal injury or death associated with such unintended or unauthorized use, even if such claim alleges that **onsemi** was negligent regarding the design or manufacture of the part. **onsemi** is an Equal Opportunity/Affirmative Action Employer. This literature is subject to all applicable copyright laws and is not for resale in any manner.

ADDITIONAL INFORMATION

TECHNICAL PUBLICATIONS:

Technical Library: www.onsemi.com/design/resources/technical-documentation
onsemi Website: www.onsemi.com

ONLINE SUPPORT: www.onsemi.com/support

For additional information, please contact your local Sales Representative at www.onsemi.com/support/sales