

MOSFET – Dual, N-Channel, POWERTRENCH®

2.5 V Specified

FDS9926A

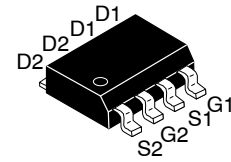

SOIC8
CASE 751EB

General Description

These N-Channel 2.5 V specified MOSFETs use onsemi's advanced POWERTRENCH process. It has been optimized for power management applications with a wide range of gate drive voltage (2.5 V – 10 V).

Features

- 6.5 A, 20 V. $R_{DS(ON)} = 30\text{ m}\Omega @ V_{GS} = 4.5\text{ V}$
 $R_{DS(ON)} = 43\text{ m}\Omega @ V_{GS} = 2.5\text{ V}$
- Optimized for Use in Battery Protection Circuits
- Low Gate Charge
- This Device is Pb-Free and Halide Free

Applications

- Battery Protection
- Load Switch
- Power Management

ABSOLUTE MAXIMUM RATINGS ($T_A = 25^\circ\text{C}$ unless otherwise noted)

Symbol	Parameter	Ratings	Unit
V_{DSS}	Drain-Source Voltage	20	V
V_{GSS}	Gate-Source Voltage	± 10	V
I_D	Drain Current	Continuous (Note 1a)	6.5
		Pulsed	20
P_D	Power Dissipation	for Dual Operation	2
		for Single Operation (Note 1a)	1.6
		(Note 1b)	1
	(Note 1c)	0.9	
T_J, T_{STG}	Operating and Storage Junction Temperature Range	-55 to +150	$^\circ\text{C}$

Stresses exceeding those listed in the Maximum Ratings table may damage the device. If any of these limits are exceeded, device functionality should not be assumed, damage may occur and reliability may be affected.

THERMAL CHARACTERISTICS

Symbol	Parameter	Ratings	Unit
$R_{\theta JA}$	Thermal Resistance, Junction to Ambient (Note 1a)	78	$^\circ\text{C/W}$
$R_{\theta JC}$	Thermal Resistance, Junction to Case (Note 1)	40	$^\circ\text{C/W}$

MARKING DIAGRAM

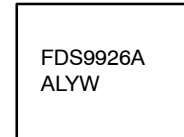

FDS9926A = Specific Device Code
A = Assembly Site
L = Wafer Lot Number
YW = Assembly Start Week

ELECTRICAL CONNECTION

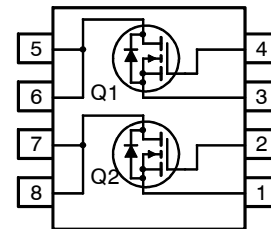

ORDERING INFORMATION

Device	Package	Shipping†
FDS9926A	SOIC8	2500 / Tape & Reel

†For information on tape and reel specifications, including part orientation and tape sizes, please refer to our Tape and Reel Packaging Specification Brochure, [BRD8011/D](#).

FDS9926A

ELECTRICAL CHARACTERISTICS (T_A = 25°C unless otherwise noted)

Symbol	Parameter	Test Condition	Min	Typ	Max	Unit
--------	-----------	----------------	-----	-----	-----	------

OFF CHARACTERISTICS

BV _{DSS}	Drain-Source Breakdown Voltage	V _{GS} = 0 V, I _D = 250 μA	20	-	-	V
$\frac{\Delta BV_{DSS}}{\Delta T_J}$	Breakdown Voltage Temperature Coefficient	I _D = 250 μA, Referenced to 25°C	-	14	-	mV/°C
I _{DSS}	Zero Gate Voltage Drain Current	V _{DS} = 16 V, V _{GS} = 0 V	-	-	1	μA
I _{GSS}	Gate-Body Leakage	V _{GS} = ±8 V, V _{DS} = 0 V	-	-	±100	nA

ON CHARACTERISTICS (Note 2)

V _{GS(th)}	Gate Threshold Voltage	V _{DS} = V _{GS} , I _D = 250 μA	0.6	1	1.5	V
$\frac{\Delta V_{GS(th)}}{\Delta T_J}$	Gate Threshold Voltage Temperature Coefficient	I _D = 250 μA, Referenced to 25°C	-	-3	-	mV/°C
R _{DS(on)}	Static Drain-Source On-Resistance	V _{GS} = 4.5 V, I _D = 6.5 A	-	25	30	mΩ
		V _{GS} = 2.5 V, I _D = 5.4 A	-	35	43	
		V _{GS} = 4.5 V, I _D = 6.5 A, T _J = 125°C	-	35	50	
I _{D(on)}	On-State Drain Current	V _{GS} = 4.5 V, V _{DS} = 5 A	15	-	-	A
g _{FS}	Forward Transconductance	V _{DS} = 5 V, I _D = 6.5 A	-	22	-	S

DYNAMIC CHARACTERISTICS

C _{iss}	Input Capacitance	V _{DS} = 10 V, V _{GS} = 0 V, f = 1.0 MHz	-	650	-	pF
C _{oss}	Output Capacitance		-	150	-	pF
C _{rss}	Reverse Transfer Capacitance		-	85	-	pF
R _G	Gate Resistance	V _{GS} = 15 mV, f = 1.0 MHz	-	1.4	-	Ω

SWITCHING CHARACTERISTICS (Note 2)

t _{d(on)}	Turn-On Delay Time	V _{DD} = 10 V, I _D = 1 A, V _{GS} = 4.5 V, R _{GEN} = 6 Ω	-	8	16	ns
t _r	Turn-On Rise Time		-	9	17	ns
t _{d(off)}	Turn-Off Delay Time		-	15	26	ns
t _f	Turn-Off Fall Time		-	4	9	ns
Q _g	Total Gate Charge	V _{DS} = 10 V, I _D = 3 A, V _{GS} = 4.5 V	-	6.2	9	nC
Q _{gs}	Gate-Source Charge		-	1.2	-	nC
Q _{gd}	Gate-Drain Charge		-	1.7	-	nC

DRAIN-SOURCE DIODE CHARACTERISTICS AND MAXIMUM RATINGS

V _{SD}	Drain-Source Diode Forward Voltage	V _{GS} = 0 V, I _S = 1.3 A (Note 2)	-	0.73	1.3	V
t _{rr}	Diode Reverse Recovery Time	I _F = 6.5 A, dI _F /dt = 100 A/μs	-	15	-	ns
Q _{rr}	Diode Reverse Recovery Charge		-	5	-	nC

Product parametric performance is indicated in the Electrical Characteristics for the listed test conditions, unless otherwise noted. Product performance may not be indicated by the Electrical Characteristics if operated under different conditions.

- R_{θJA} is the sum of the junction-to-case and case-to-ambient thermal resistance where the case thermal reference is defined as the solder mounting surface of the drain pins. R_{θJC} is guaranteed by design while R_{QCA} is determined by the user's board design.

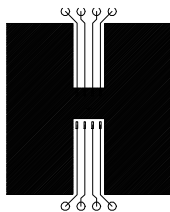

a) 78°C/W when mounted on a 0.5 in² pad of 2 oz. Copper

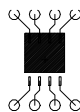

b) 125°C/W when mounted on a 0.02 in² pad of 2 oz. copper

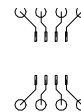

c) 135°C/W when mounted on a minimum pad.

- Pulse Test Pulse Width < 300 μs, Duty Cycle < 2.0%

TYPICAL CHARACTERISTICS

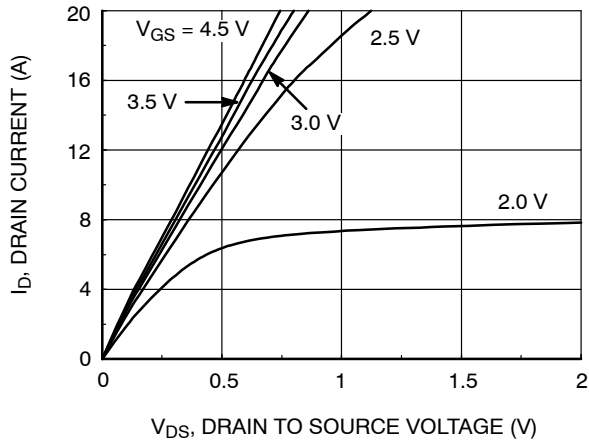

Figure 1. On-Region Characteristics

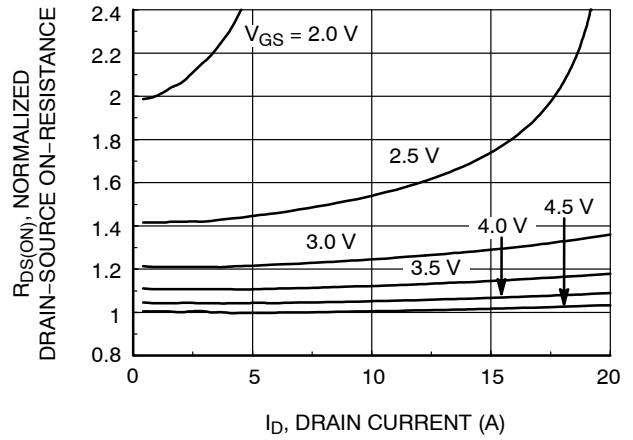

Figure 2. On-Resistance Variation with Drain Current and Gate Voltage

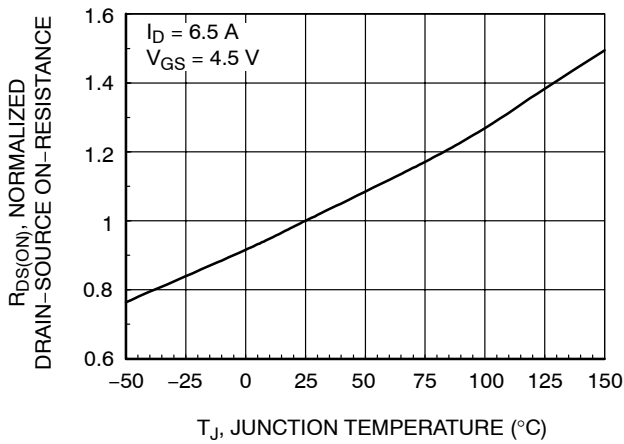

Figure 3. On-Resistance Variation with Temperature

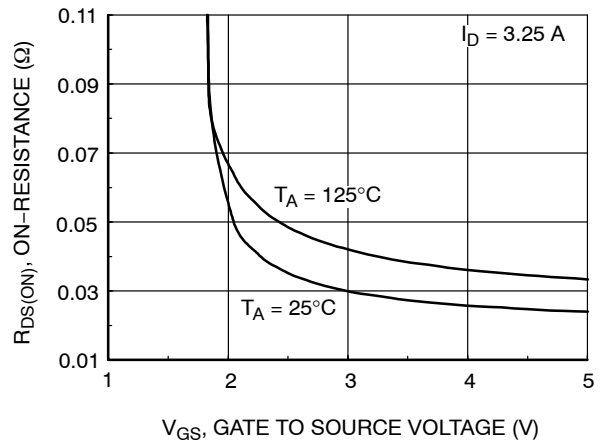

Figure 4. On-Resistance Variation with Gate-to-Source Voltage

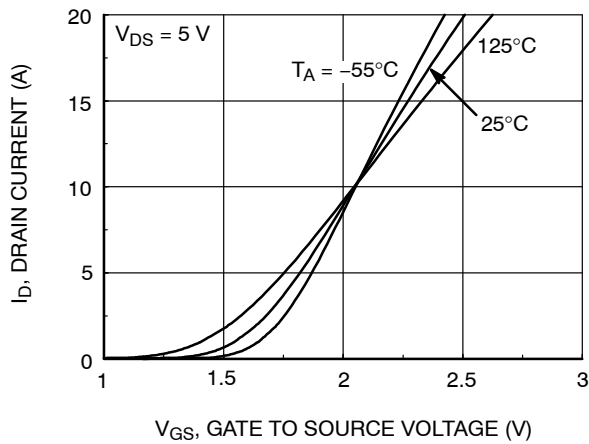

Figure 5. Transfer Characteristics

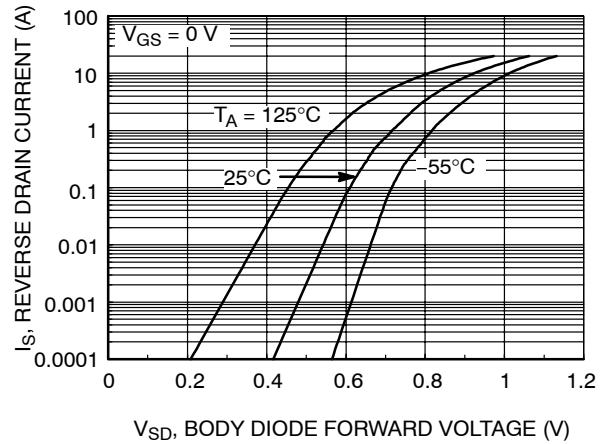

Figure 6. Body Diode Forward Voltage Variation with Source Current and Temperature

TYPICAL CHARACTERISTICS (continued)

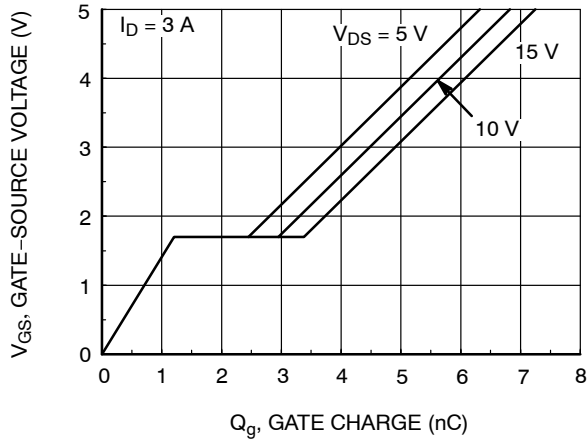

Figure 7. Gate-Charge Characteristics

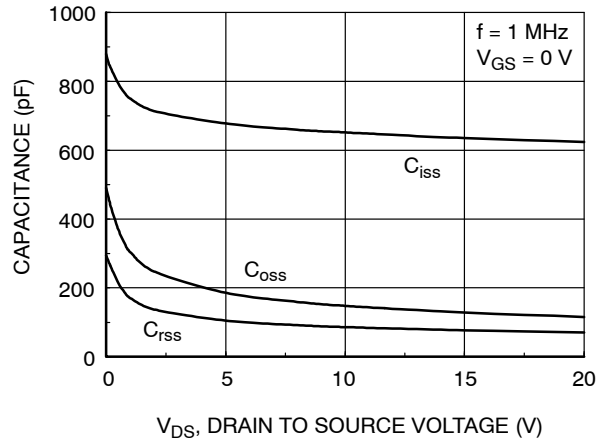

Figure 8. Capacitance Characteristics

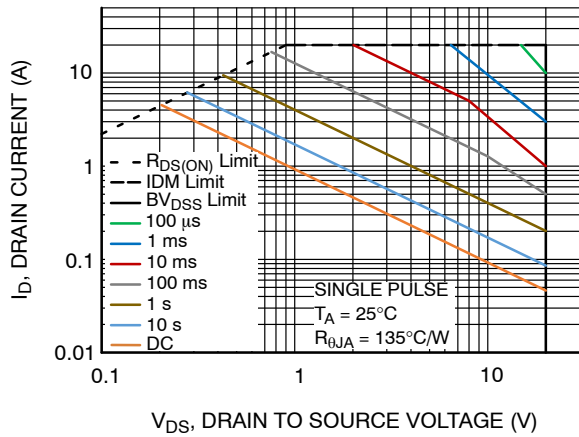

Figure 9. Maximum Safe Operating Area

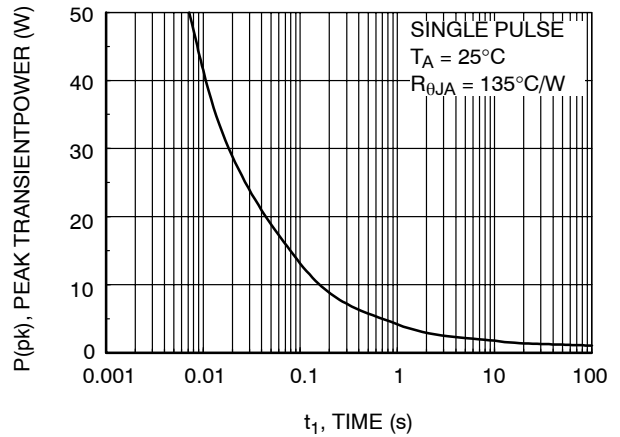

Figure 10. Single Pulse Maximum Power Dissipation

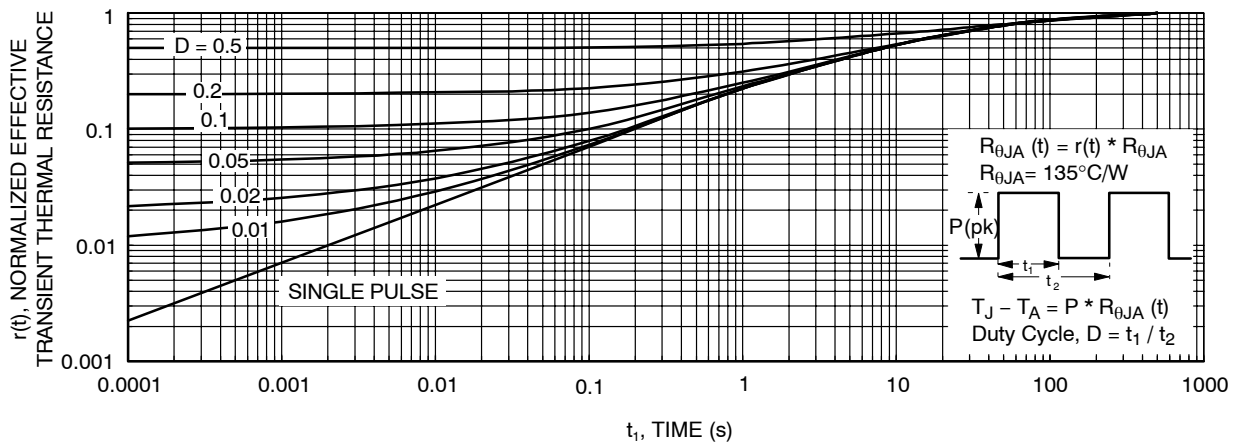

Figure 11. Transient Thermal Response Curve

Thermal characterization performed using the conditions described in Note 1c.
 Transient thermal response will change depending on the circuit board design.

MECHANICAL CASE OUTLINE
PACKAGE DIMENSIONS

ON Semiconductor®



SOIC8
CASE 751EB
ISSUE A

DATE 24 AUG 2017

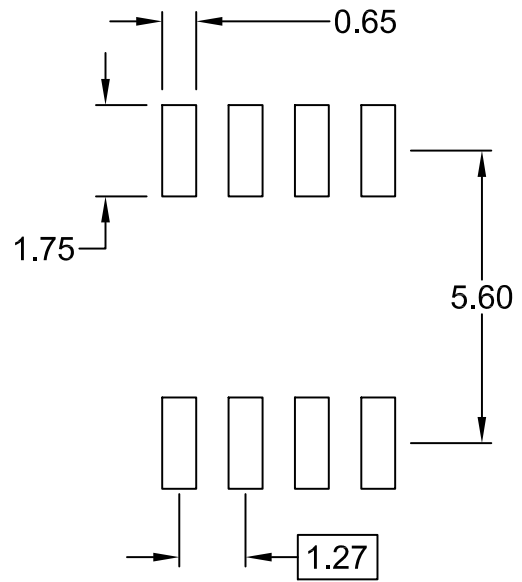
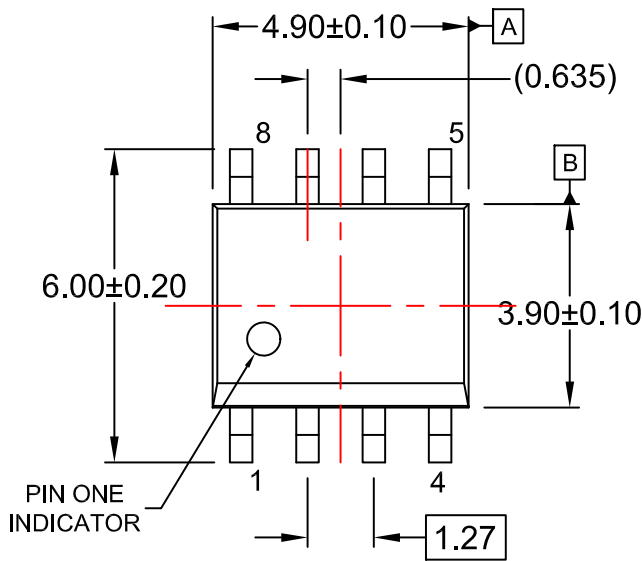

⊕ 0.25 (M) C B A

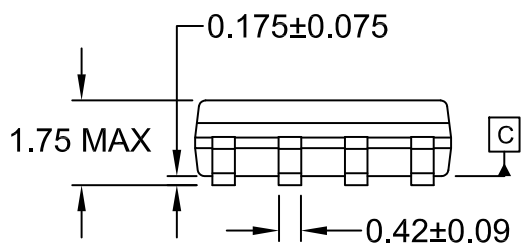

⌒ 0.10

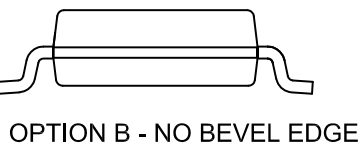
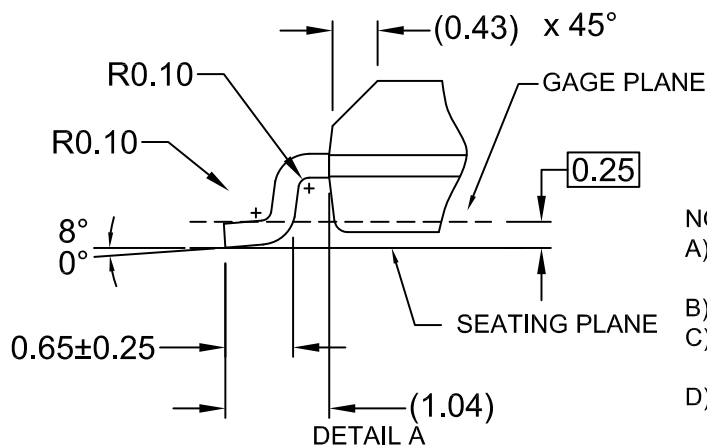
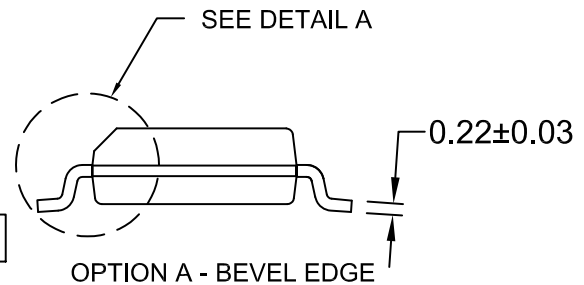

NOTES:

- A) THIS PACKAGE CONFORMS TO JEDEC MS-012, VARIATION AA.
- B) ALL DIMENSIONS ARE IN MILLIMETERS.
- C) DIMENSIONS DO NOT INCLUDE MOLD FLASH OR BURRS.
- D) LANDPATTERN STANDARD: SOIC127P600X175-8M

DOCUMENT NUMBER:	98AON13735G	Electronic versions are uncontrolled except when accessed directly from the Document Repository. Printed versions are uncontrolled except when stamped "CONTROLLED COPY" in red.
DESCRIPTION:	SOIC8	PAGE 1 OF 1

ON Semiconductor and ON are trademarks of Semiconductor Components Industries, LLC dba ON Semiconductor or its subsidiaries in the United States and/or other countries. ON Semiconductor reserves the right to make changes without further notice to any products herein. ON Semiconductor makes no warranty, representation or guarantee regarding the suitability of its products for any particular purpose, nor does ON Semiconductor assume any liability arising out of the application or use of any product or circuit, and specifically disclaims any and all liability, including without limitation special, consequential or incidental damages. ON Semiconductor does not convey any license under its patent rights nor the rights of others.

onsemi, **Onsemi**, and other names, marks, and brands are registered and/or common law trademarks of Semiconductor Components Industries, LLC dba "**onsemi**" or its affiliates and/or subsidiaries in the United States and/or other countries. **onsemi** owns the rights to a number of patents, trademarks, copyrights, trade secrets, and other intellectual property. A listing of **onsemi**'s product/patent coverage may be accessed at www.onsemi.com/site/pdf/Patent-Marking.pdf. **onsemi** reserves the right to make changes at any time to any products or information herein, without notice. The information herein is provided "as-is" and **onsemi** makes no warranty, representation or guarantee regarding the accuracy of the information, product features, availability, functionality, or suitability of its products for any particular purpose, nor does **onsemi** assume any liability arising out of the application or use of any product or circuit, and specifically disclaims any and all liability, including without limitation special, consequential or incidental damages. Buyer is responsible for its products and applications using **onsemi** products, including compliance with all laws, regulations and safety requirements or standards, regardless of any support or applications information provided by **onsemi**. "Typical" parameters which may be provided in **onsemi** data sheets and/or specifications can and do vary in different applications and actual performance may vary over time. All operating parameters, including "Typicals" must be validated for each customer application by customer's technical experts. **onsemi** does not convey any license under any of its intellectual property rights nor the rights of others. **onsemi** products are not designed, intended, or authorized for use as a critical component in life support systems or any FDA Class 3 medical devices or medical devices with a same or similar classification in a foreign jurisdiction or any devices intended for implantation in the human body. Should Buyer purchase or use **onsemi** products for any such unintended or unauthorized application, Buyer shall indemnify and hold **onsemi** and its officers, employees, subsidiaries, affiliates, and distributors harmless against all claims, costs, damages, and expenses, and reasonable attorney fees arising out of, directly or indirectly, any claim of personal injury or death associated with such unintended or unauthorized use, even if such claim alleges that **onsemi** was negligent regarding the design or manufacture of the part. **onsemi** is an Equal Opportunity/Affirmative Action Employer. This literature is subject to all applicable copyright laws and is not for resale in any manner.

ADDITIONAL INFORMATION

TECHNICAL PUBLICATIONS:

Technical Library: www.onsemi.com/design/resources/technical-documentation
onsemi Website: www.onsemi.com

ONLINE SUPPORT: www.onsemi.com/support

For additional information, please contact your local Sales Representative at www.onsemi.com/support/sales