

MOSFET – P-Channel, POWERTRENCH®

-30 V, -14.5 A, 7.8 mΩ

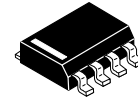

SOIC8
CASE 751EB

FDS6673BZ

General Description

This P-Channel MOSFET is produced using onsemi's advanced Power Trench process that has been especially tailored to minimize the on-state resistance.

This device is well suited for Power Management and load switching applications common in Notebook Computers and Portable Battery Packs.

Features

- Max $R_{DS(on)}$ = 7.8 mΩ @ $V_{GS} = -10$ V, $I_D = -14.5$ A
- Max $R_{DS(on)}$ = 12 mΩ @ $V_{GS} = -4.5$ V, $I_D = -12$ A
- Extended V_{GS} Range (-25 V) for Battery Applications
- HBM ESD Protection Level of 6.5 kV Typical (Note 3)
- High Performance Trench Technology for Extremely Low $R_{DS(on)}$
- High Power and Current Handling Capability
- Pb-Free, Halide Free and RoHS Compliant

ABSOLUTE MAXIMUM RATINGS

$T_A = 25^\circ\text{C}$ unless otherwise noted.

Symbol	Parameter	Ratings	Unit
V_{DS}	Drain to Source Voltage	-30	V
V_{GS}	Gate to Source Voltage	±25	V
I_D	Drain Current - Continuous (Note 1a) - Pulsed	-14.5 -75	A
P_D	Maximum Power dissipation (Note 1a) (Note 1b) (Note 1c)	2.5 1.2 1.0	W
T_J, T_{STG}	Operating and Storage Junction Temperature Range	-55 to +150	°C

Stresses exceeding those listed in the Maximum Ratings table may damage the device. If any of these limits are exceeded, device functionality should not be assumed, damage may occur and reliability may be affected.

THERMAL CHARACTERISTICS

Symbol	Parameter	Ratings	Unit
$R_{\theta JA}$	Thermal Resistance, Junction to Ambient (Note 1a)	50	°C/W
$R_{\theta JC}$	Thermal Resistance, Junction to Case (Note 1)	25	°C/W

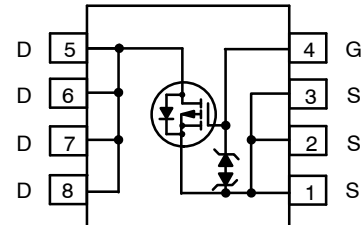

MARKING DIAGRAM

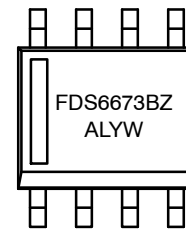

FDS6673BZ = Specific Device Code
A = Assembly Side
L = Wafer Lot Number
YW = Assembly Start Week

ORDERING INFORMATION

Device	Package	Shipping†
FDS6673BZ	SOIC8 (Pb-Free/ Halide Free)	2500 / Tape & Reel

†For information on tape and reel specifications, including part orientation and tape sizes, please refer to our Tape and Reel Packaging Specification Brochure, [BRD8011/D](#).

FDS6673BZ

ELECTRICAL CHARACTERISTICS $T_A = 25^\circ\text{C}$ unless otherwise noted.

Symbol	Parameter	Test Conditions	Min	Typ	Max	Unit
--------	-----------	-----------------	-----	-----	-----	------

OFF CHARACTERISTICS

BV_{DSS}	Drain to Source Breakdown Voltage	$I_D = -250 \mu\text{A}, V_{GS} = 0 \text{ V}$	-30	-	-	V
$\frac{\Delta BV_{DSS}}{\Delta T_J}$	Breakdown Voltage Temperature Coefficient	$I_D = -250 \mu\text{A}$, Referenced to 25°C	-	-20	-	mV/ $^\circ\text{C}$
I_{DSS}	Zero Gate Voltage Drain Current	$V_{DS} = -24 \text{ V}, V_{GS} = 0 \text{ V}$	-	-	-1	μA
I_{GSS}	Gate-Body Leakage	$V_{GS} = \pm 25 \text{ V}, V_{DS} = 0 \text{ V}$	-	-	± 10	μA

ON CHARACTERISTICS (Note 2)

$V_{GS(th)}$	Gate to Source Threshold Voltage	$V_{DS} = V_{GS}, I_D = -250 \mu\text{A}$	-1	-1.9	-3	V
$\frac{\Delta V_{GS(th)}}{\Delta T_J}$	Gate to Source Threshold Voltage Temperature Coefficient	$I_D = -250 \mu\text{A}$, Referenced to 25°C	-	8.1	-	mV/ $^\circ\text{C}$
$R_{DS(on)}$	Drain to Source On-Resistance	$I_D = -14.5 \text{ A}, V_{GS} = -10 \text{ V}$,	-	6.5	7.8	m Ω
		$I_D = -12 \text{ A}, V_{GS} = -4.5 \text{ V}$	-	9.6	12	
		$I_D = -14.5 \text{ A}, V_{GS} = -10 \text{ V}$, $T_J = 125^\circ\text{C}$	-	9.7	12	
g_{FS}	Forward Transconductance	$V_{DS} = -5 \text{ V}, I_D = -14.5 \text{ A}$	-	60	-	S

DYNAMIC CHARACTERISTICS

C_{iss}	Input Capacitance	$V_{DS} = -15 \text{ V}, V_{GS} = 0 \text{ V}$, $f = 1.0 \text{ MHz}$	-	3500	4700	pF
C_{oss}	Output Capacitance		-	600	800	
C_{rss}	Reverse Transfer Capacitance		-	600	900	

SWITCHING CHARACTERISTICS (Note 2)

$t_{d(on)}$	Turn-On Delay Time	$V_{DD} = -15 \text{ V}, I_D = -1 \text{ A}$, $V_{GS} = -10 \text{ V}, R_{GS} = 6 \Omega$	-	14	26	ns	
t_r	Rise Time		-	16	29		
$t_{d(off)}$	Turn-Off Delay Time		-	225	306		
t_f	Fall Time		-	105	167		
Q_g	Total Gate Charge	$V_{DS} = -15 \text{ V}, I_D = -14.5 \text{ A}$, $V_{GS} = -10 \text{ V}$	-	88	124	nC	
Q_g	Total Gate Charge		$V_{DS} = -15 \text{ V}, I_D = -14.5 \text{ A}$, $V_{GS} = -5 \text{ V}$	-	46		65
Q_{gs}	Gate-Source Charge			-	8		-
Q_{gd}	Gate-Drain Charge			-	23.5		-

DRAIN-SOURCE DIODE CHARACTERISTICS AND MAXIMUM RATINGS

V_{SD}	Drain to Source Diode Forward Voltage	$V_{GS} = 0 \text{ V}, I_S = -2.1 \text{ A}$	-	-0.7	-1.2	V
t_{rr}	Reverse Recovery Time	$I_F = 14.5 \text{ A}, di/dt = 100 \text{ A}/\mu\text{s}$	-	-	45	ns
Q_{rr}	Reverse Recovery Charge	$I_F = 14.5 \text{ A}, di/dt = 100 \text{ A}/\mu\text{s}$	-	-	34	nC

Product parametric performance is indicated in the Electrical Characteristics for the listed test conditions, unless otherwise noted. Product performance may not be indicated by the Electrical Characteristics if operated under different conditions.

NOTES:

- $R_{\theta JA}$ is the sum of the junction-to-case and case-to-ambient thermal resistance where the case thermal reference is defined as the solder mounting surface of the drain pins. $R_{\theta JC}$ is guaranteed by design while $R_{\theta CA}$ is determined by the user's board design.

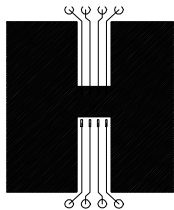

a) $50^\circ\text{C}/\text{W}$ (10 sec) when mounted on a 1 in^2 pad of 2 oz. copper.

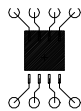

b) $105^\circ\text{C}/\text{W}$ when mounted on a 0.04 in^2 pad of 2 oz. copper.

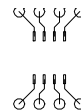

b) $125^\circ\text{C}/\text{W}$ when mounted on a minimum pad.

- Pulse Test: Pulse Width $< 300 \mu\text{s}$, Duty Cycle $< 2.0\%$
- The diode connected between the gate and source serves only as protection against ESD. No gate overvoltage rating is implied.

TYPICAL CHARACTERISTICS

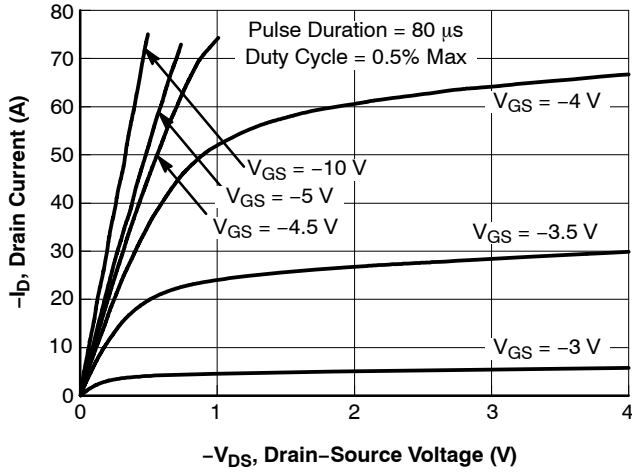

Figure 1. On Region Characteristics

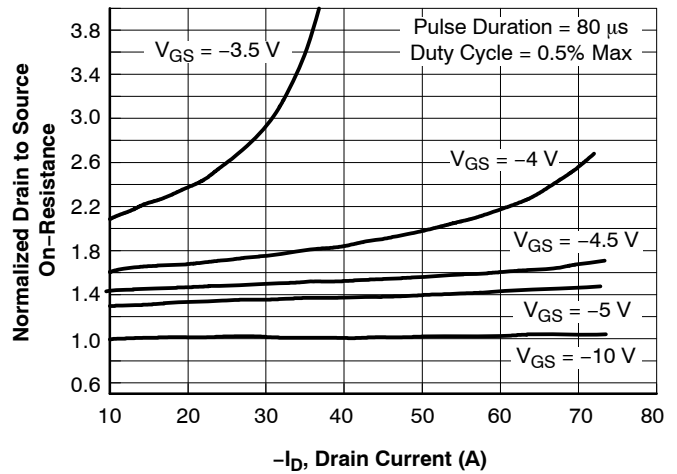

Figure 2. Normalized On-Resistance vs. Drain Current and Gate Voltage

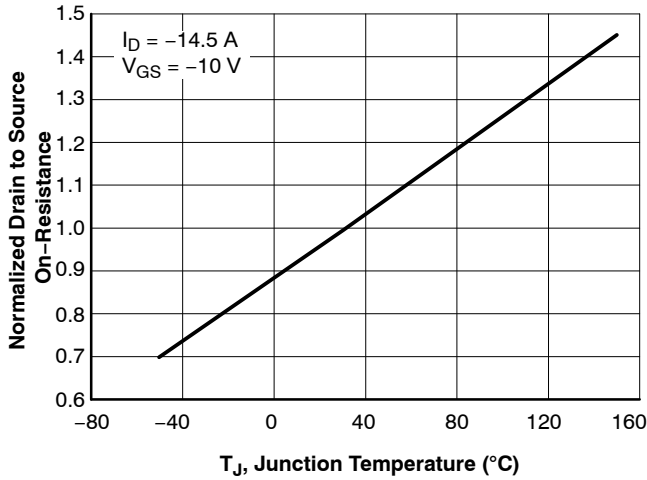

Figure 3. Normalized On-Resistance vs. Junction Temperature

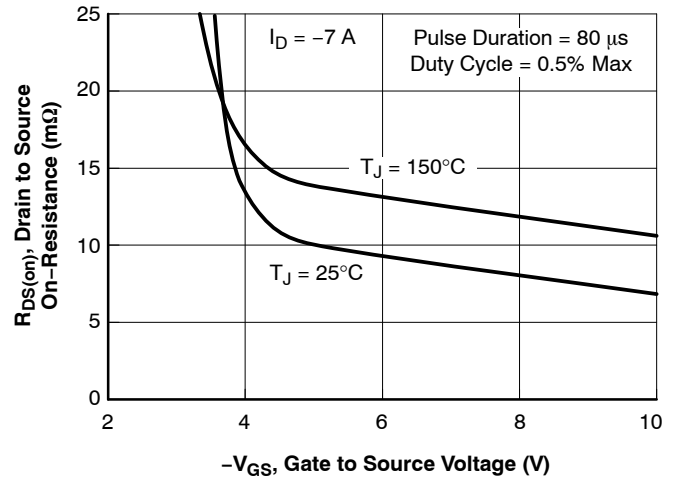

Figure 4. On-Resistance vs. Gate to Source Voltage

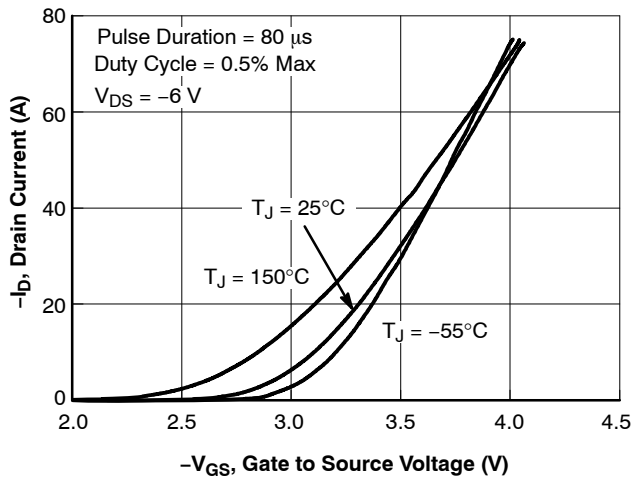

Figure 5. Transfer Characteristics

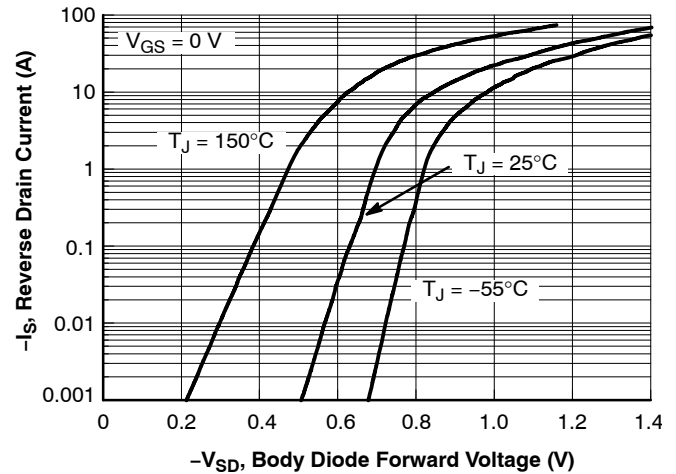

Figure 6. Source to Drain Diode Forward Voltage vs. Source Current

TYPICAL CHARACTERISTICS (continued)

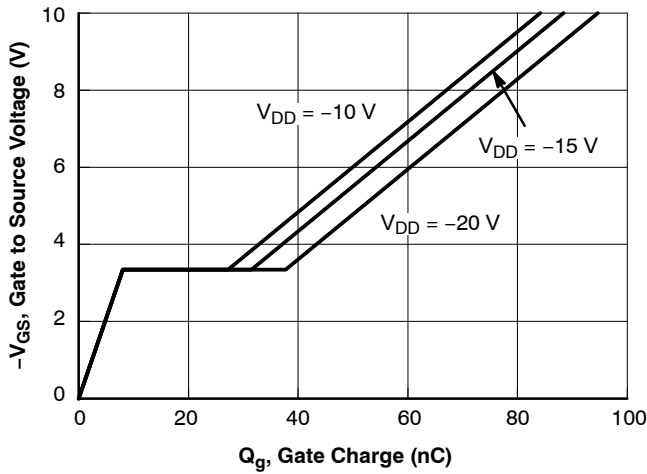

Figure 7. Gate Charge Characteristics

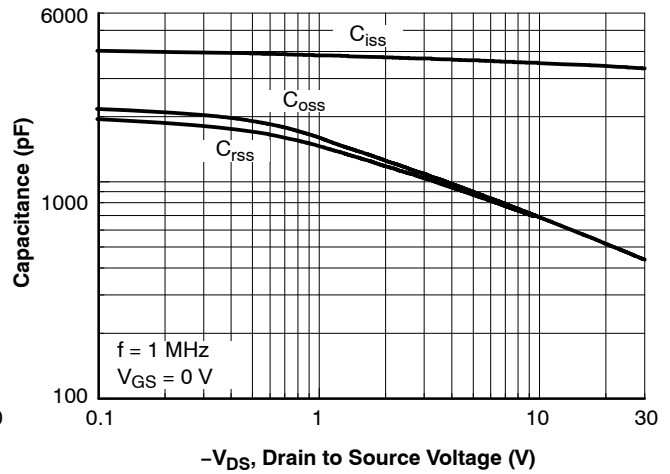

Figure 8. Capacitance vs. Drain to Source Voltage

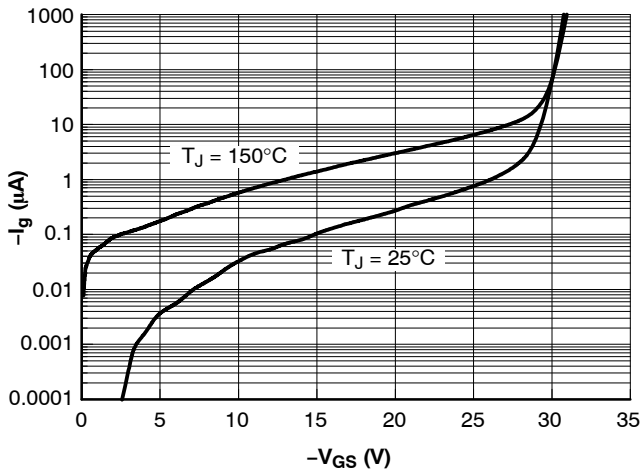

Figure 9. I_g vs. V_{GS}

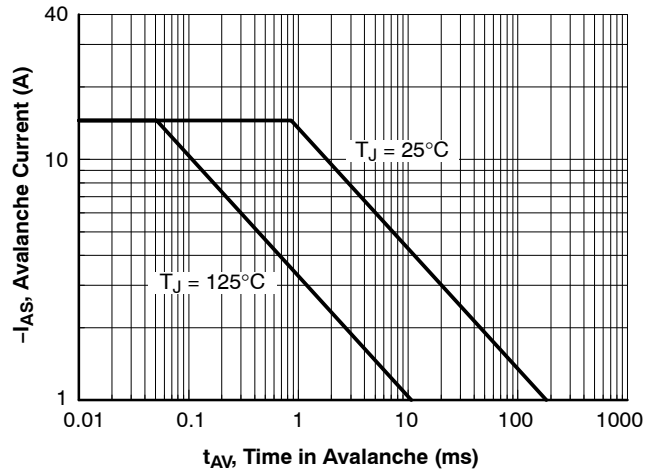

Figure 10. Unclamped Inductive Switching Capability

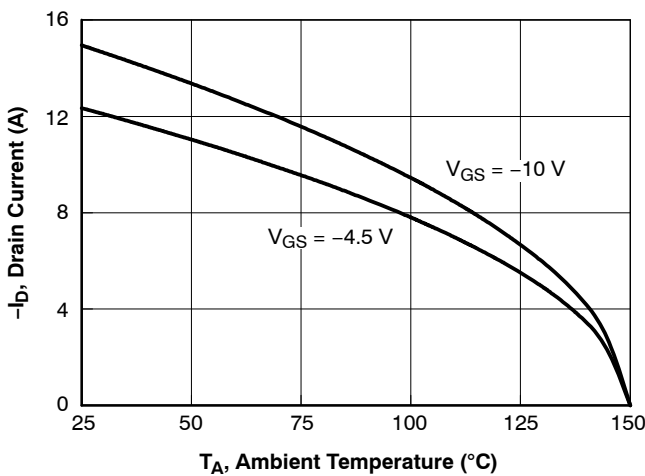

Figure 11. Maximum Continuous Drain Current vs Ambient Temperature

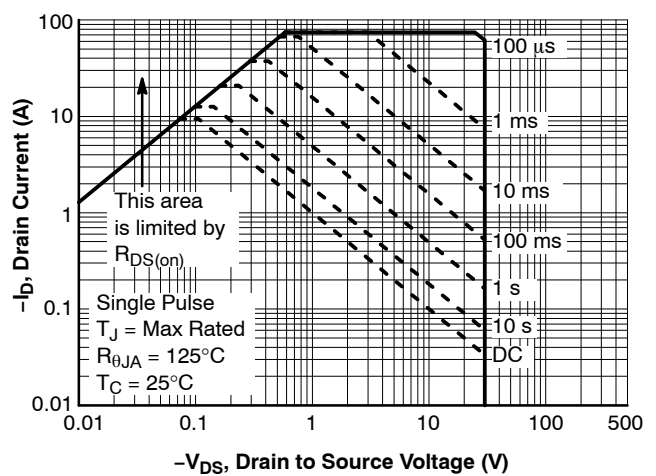

Figure 12. Single Pulse Maximum Power Dissipation

TYPICAL CHARACTERISTICS (continued)

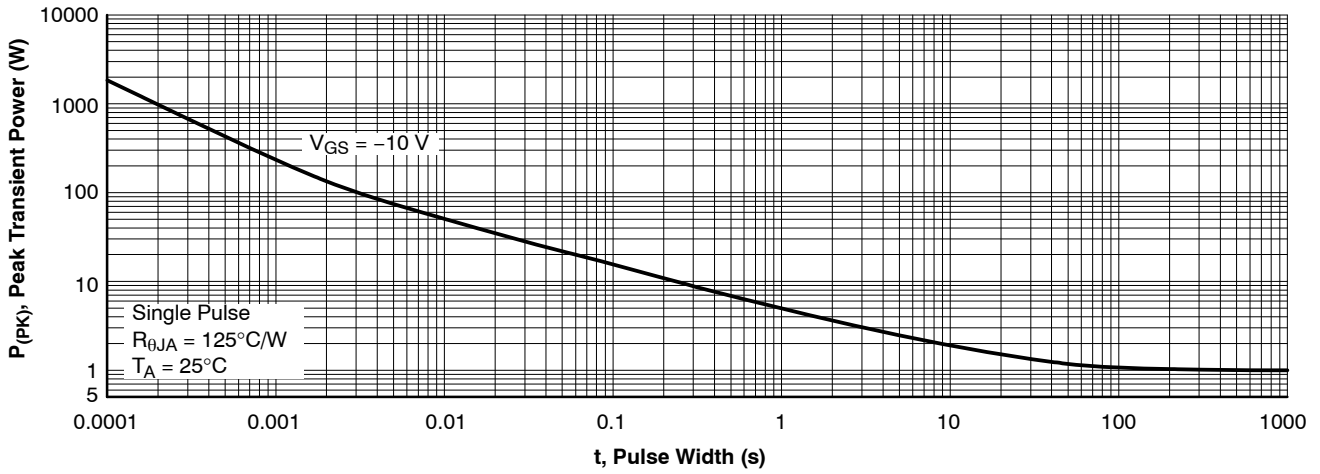

Figure 13. Single Pulse Maximum Power Dissipation

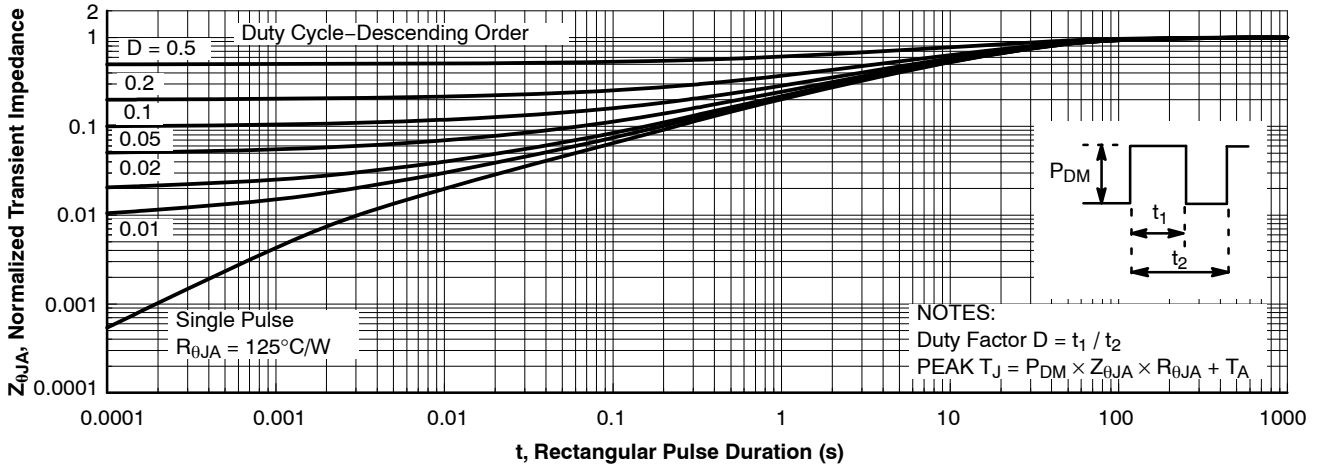

Figure 14. Junction-to-Ambient Transient Thermal Response Curve

MECHANICAL CASE OUTLINE
PACKAGE DIMENSIONS

ON Semiconductor®



SOIC8
CASE 751EB
ISSUE A

DATE 24 AUG 2017

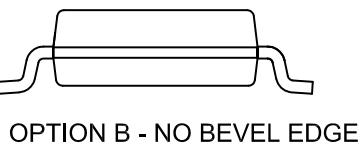
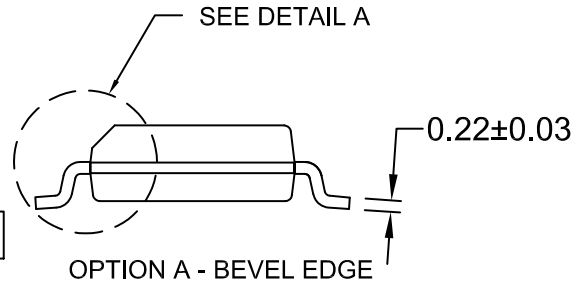
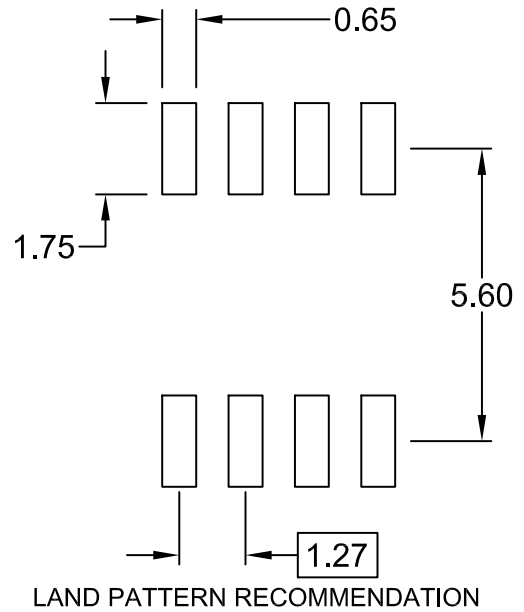

- NOTES:
 A) THIS PACKAGE CONFORMS TO JEDEC MS-012, VARIATION AA.
 B) ALL DIMENSIONS ARE IN MILLIMETERS.
 C) DIMENSIONS DO NOT INCLUDE MOLD FLASH OR BURRS.
 D) LANDPATTERN STANDARD: SOIC127P600X175-8M

DOCUMENT NUMBER:	98AON13735G	Electronic versions are uncontrolled except when accessed directly from the Document Repository. Printed versions are uncontrolled except when stamped "CONTROLLED COPY" in red.
DESCRIPTION:	SOIC8	PAGE 1 OF 1

ON Semiconductor and are trademarks of Semiconductor Components Industries, LLC dba ON Semiconductor or its subsidiaries in the United States and/or other countries. ON Semiconductor reserves the right to make changes without further notice to any products herein. ON Semiconductor makes no warranty, representation or guarantee regarding the suitability of its products for any particular purpose, nor does ON Semiconductor assume any liability arising out of the application or use of any product or circuit, and specifically disclaims any and all liability, including without limitation special, consequential or incidental damages. ON Semiconductor does not convey any license under its patent rights nor the rights of others.

onsemi, **Onsemi**, and other names, marks, and brands are registered and/or common law trademarks of Semiconductor Components Industries, LLC dba "**onsemi**" or its affiliates and/or subsidiaries in the United States and/or other countries. **onsemi** owns the rights to a number of patents, trademarks, copyrights, trade secrets, and other intellectual property. A listing of **onsemi**'s product/patent coverage may be accessed at www.onsemi.com/site/pdf/Patent-Marking.pdf. **onsemi** reserves the right to make changes at any time to any products or information herein, without notice. The information herein is provided "as-is" and **onsemi** makes no warranty, representation or guarantee regarding the accuracy of the information, product features, availability, functionality, or suitability of its products for any particular purpose, nor does **onsemi** assume any liability arising out of the application or use of any product or circuit, and specifically disclaims any and all liability, including without limitation special, consequential or incidental damages. Buyer is responsible for its products and applications using **onsemi** products, including compliance with all laws, regulations and safety requirements or standards, regardless of any support or applications information provided by **onsemi**. "Typical" parameters which may be provided in **onsemi** data sheets and/or specifications can and do vary in different applications and actual performance may vary over time. All operating parameters, including "Typicals" must be validated for each customer application by customer's technical experts. **onsemi** does not convey any license under any of its intellectual property rights nor the rights of others. **onsemi** products are not designed, intended, or authorized for use as a critical component in life support systems or any FDA Class 3 medical devices or medical devices with a same or similar classification in a foreign jurisdiction or any devices intended for implantation in the human body. Should Buyer purchase or use **onsemi** products for any such unintended or unauthorized application, Buyer shall indemnify and hold **onsemi** and its officers, employees, subsidiaries, affiliates, and distributors harmless against all claims, costs, damages, and expenses, and reasonable attorney fees arising out of, directly or indirectly, any claim of personal injury or death associated with such unintended or unauthorized use, even if such claim alleges that **onsemi** was negligent regarding the design or manufacture of the part. **onsemi** is an Equal Opportunity/Affirmative Action Employer. This literature is subject to all applicable copyright laws and is not for resale in any manner.

ADDITIONAL INFORMATION

TECHNICAL PUBLICATIONS:

Technical Library: www.onsemi.com/design/resources/technical-documentation
onsemi Website: www.onsemi.com

ONLINE SUPPORT: www.onsemi.com/support

For additional information, please contact your local Sales Representative at www.onsemi.com/support/sales