

MOSFET – N-Channel, UniFET™ II

500 V, 22 A, 220 mΩ

FDP22N50N

Description

UniFET II MOSFET is onsemi's high voltage MOSFET family based on advanced planar stripe and DMOS technology. This advanced MOSFET family has the smallest on-state resistance among the planar MOSFET, and also provides superior switching performance and higher avalanche energy strength. In addition, internal gate-source ESD diode allows UniFET II MOSFET to withstand over 2 kV HBM surge stress. This device family is suitable for switching power converter applications such as power factor correction (PFC), flat panel display (FPD) TV power, ATX and electronic lamp ballasts.

Features

- $R_{DS(on)} = 185 \text{ m}\Omega$ (Typ.) @ $V_{GS} = 10 \text{ V}$, $I_D = 11 \text{ A}$
- Low Gate Charge (Typ. 49 nC)
- Low C_{rss} (Typ. 24 pF)
- 100% Avalanche Tested
- Improved dv/dt Capability
- RoHS Compliant

Applications

- PDP TV
- Lighting
- Uninterruptible Power Supply
- AC-DC Power Supply

| V_{DSS} | $R_{DS(on)}$ MAX | I_D MAX |
|-----------|------------------|-----------|
| 500 V | 220 mΩ @ 10 V | 22 A |

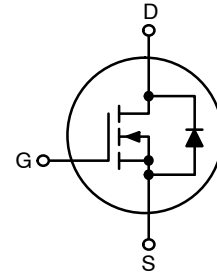

N-Channel

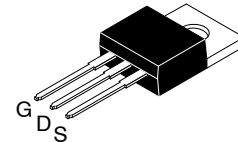

TO-220-3LD
 CASE 340AT

MARKING DIAGRAM

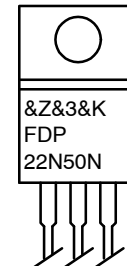

&Z = Assembly Plant Code
 &3 = 3-Digit Date Code
 &K = 2-Digits Lot Run Code
 FDP22N50N = Specific Device Code

ORDERING INFORMATION

| Device | Package | Shipping |
|-----------|------------|-------------------|
| FDP22N50N | TO-220-3LD | 1000 Units / Tube |

FDP22N50N

MOSFET MAXIMUM RATINGS ($T_C = 25^\circ\text{C}$ unless otherwise noted)

| Symbol | Parameter | FDP22N50N | Unit |
|----------------|--|--|------------------|
| V_{DSS} | Drain to Source Voltage | 500 | V |
| V_{GSS} | Gate to Source Voltage | ± 30 | V |
| I_D | Drain Current | - Continuous ($T_C = 25^\circ\text{C}$) | 22 |
| | | - Continuous ($T_C = 100^\circ\text{C}$) | 13.2 |
| I_{DM} | Drain Current | - Pulsed (Note 1) | 88 |
| E_{AS} | Single Pulsed Avalanche Energy (Note 2) | 1000 | mJ |
| I_{AR} | Avalanche Current (Note 1) | 22 | A |
| E_{AR} | Repetitive Avalanche Energy (Note 1) | 31.25 | mJ |
| dv/dt | Peak Diode Recovery dv/dt (Note 3) | 10 | V/ns |
| P_D | Power Dissipation | ($T_C = 25^\circ\text{C}$) | 312.5 |
| | | -Derate above 25°C | 2.5 |
| T_J, T_{STG} | Operating and Storage Temperature Range | -55 to +150 | $^\circ\text{C}$ |
| T_L | Maximum Lead Temperature for Soldering, 1/8" from Case for 5 seconds | 300 | $^\circ\text{C}$ |

Stresses exceeding those listed in the Maximum Ratings table may damage the device. If any of these limits are exceeded, device functionality should not be assumed, damage may occur and reliability may be affected.

1. Repetitive rating: pulse-width limited by maximum junction temperature.
2. $L = 4.1\text{ mH}$, $I_{AS} = 22\text{ A}$, $V_{DD} = 50\text{ V}$, $R_G = 25\ \Omega$, starting $T_J = 25^\circ\text{C}$
3. $I_{SD} \leq 22\text{ A}$, $di/dt \leq 200\text{ A}/\mu\text{s}$, $V_{DD} \leq BV_{DSS}$, starting $T_J = 25^\circ\text{C}$

THERMAL CHARACTERISTICS

| Symbol | Parameter | FDP22N50N | Unit |
|-----------------|---|-----------|---------------------------|
| $R_{\theta JC}$ | Thermal Resistance, Junction to Case, Max. | 0.4 | $^\circ\text{C}/\text{W}$ |
| $R_{\theta JA}$ | Thermal Resistance, Junction to Ambient, Max. | 62.5 | |

FDP22N50N

ELECTRICAL CHARACTERISTICS (T_C = 25°C unless otherwise noted)

| Symbol | Parameter | Test Conditions | Min | Typ | Max | Unit |
|--------|-----------|-----------------|-----|-----|-----|------|
|--------|-----------|-----------------|-----|-----|-----|------|

OFF CHARACTERISTICS

| | | | | | | |
|--------------------------------------|---|---|-----|------|------|------|
| BV _{DSS} | Drain to Source Breakdown Voltage | I _D = 250 μA, V _{GS} = 0 V | 500 | – | – | V |
| ΔBV _{DSS} / ΔT _J | Breakdown Voltage Temperature Coefficient | I _D = 250 μA, Referenced to 25°C | – | 0.45 | – | V/°C |
| I _{DSS} | Zero Gate Voltage Drain Current | V _{DS} = 500 V, V _{GS} = 0 V | – | – | 1 | μA |
| | | V _{DS} = 400 V, T _C = 125°C | – | – | 10 | |
| I _{GSS} | Gate to Body Leakage Current | V _{GS} = ±30 V, V _{DS} = 0 V | – | – | ±100 | nA |

ON CHARACTERISTICS

| | | | | | | |
|---------------------|--------------------------------------|---|-----|-------|-------|---|
| V _{GS(th)} | Gate Threshold Voltage | V _{GS} = V _{DS} , I _D = 250 μA | 3.0 | – | 5.0 | V |
| R _{DS(on)} | Static Drain to Source On Resistance | V _{GS} = 10 V, I _D = 11 A | – | 0.185 | 0.220 | Ω |
| g _{FS} | Forward Transconductance | V _{DS} = 20 V, I _D = 11 A | – | 24.4 | – | S |

DYNAMIC CHARACTERISTICS

| | | | | | | |
|---------------------|-------------------------------|--|---|------|------|----|
| C _{iss} | Input Capacitance | V _{DS} = 25 V, V _{GS} = 0 V, f = 1 MHz | – | 2456 | 3200 | pF |
| C _{oss} | Output Capacitance | | – | 351 | 460 | pF |
| C _{rss} | Reverse Transfer Capacitance | | – | 24 | 50 | pF |
| Q _{g(tot)} | Total Gate Charge at 10 V | V _{DS} = 400 V, I _D = 22 A, V _{GS} = 10 V (Note 4) | – | 49 | 65 | nC |
| Q _{gs} | Gate to Source Gate Charge | | – | 15 | – | nC |
| Q _{gd} | Gate to Drain “Miller” Charge | | – | 19 | – | nC |

SWITCHING CHARACTERISTICS

| | | | | | | |
|---------------------|---------------------|--|---|----|-----|----|
| t _{d(on)} | Turn-On Delay Time | V _{DD} = 250 V, I _D = 22 A, R _G = 4.7 Ω (Note 4) | – | 22 | 55 | ns |
| t _r | Turn-On Rise Time | | – | 50 | 110 | ns |
| t _{d(off)} | Turn-Off Delay Time | | – | 48 | 110 | ns |
| t _f | Turn-Off Fall Time | | – | 35 | 80 | ns |

DRAIN-SOURCE DIODE CHARACTERISTICS

| | | | | | | |
|-----------------|--|---|---|-----|-----|----|
| I _S | Maximum Continuous Drain to Source Diode Forward Current | – | – | 22 | A | |
| I _{SM} | Maximum Pulsed Drain to Source Diode Forward Current | – | – | 88 | A | |
| V _{SD} | Drain to Source Diode Forward Voltage | V _{GS} = 0 V, I _{SD} = 22 A | – | – | 1.4 | V |
| t _{rr} | Reverse Recovery Time | V _{GS} = 0 V, I _{SD} = 22 A, dI _F /dt = 100 A/μs | – | 472 | – | ns |
| Q _{rr} | Reverse Recovery Charge | | – | 6.5 | – | μC |

Product parametric performance is indicated in the Electrical Characteristics for the listed test conditions, unless otherwise noted. Product performance may not be indicated by the Electrical Characteristics if operated under different conditions.

4. Essentially independent of operating temperature typical characteristics.

FDP22N50N

TYPICAL PERFORMANCE CHARACTERISTICS

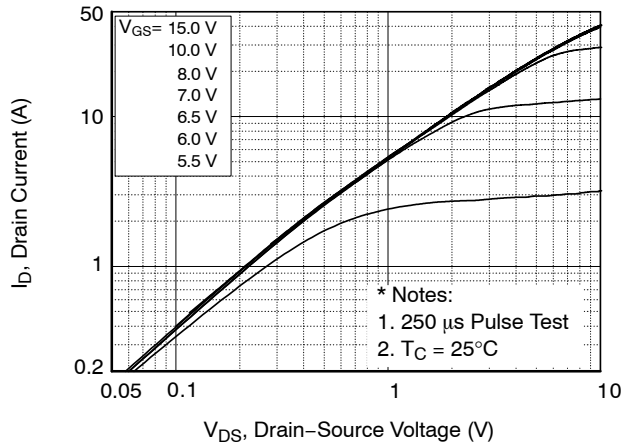

Figure 1. On-Region Characteristics

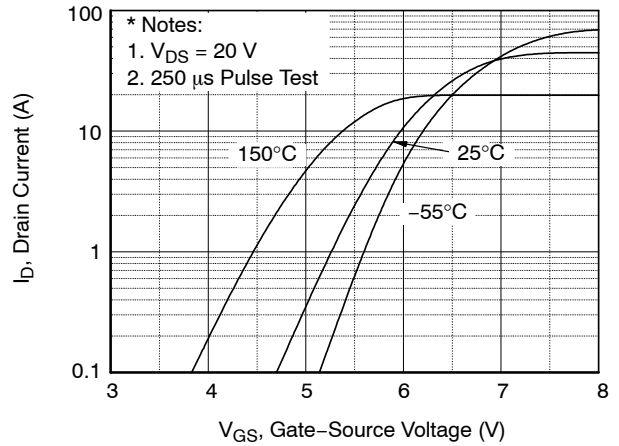

Figure 2. Transfer Characteristics

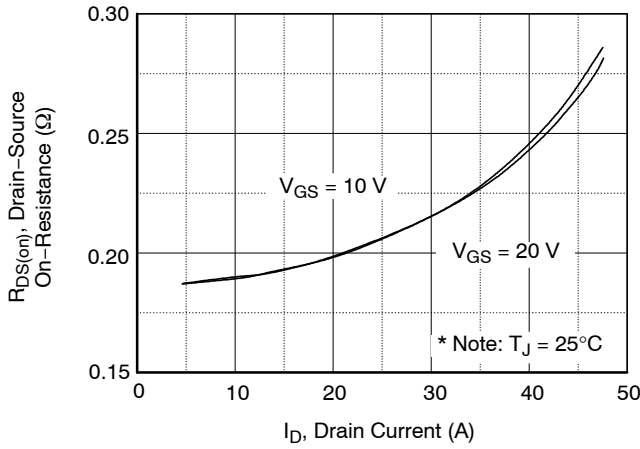

Figure 3. On-Resistance Variation vs. Drain Current and Gate Voltage

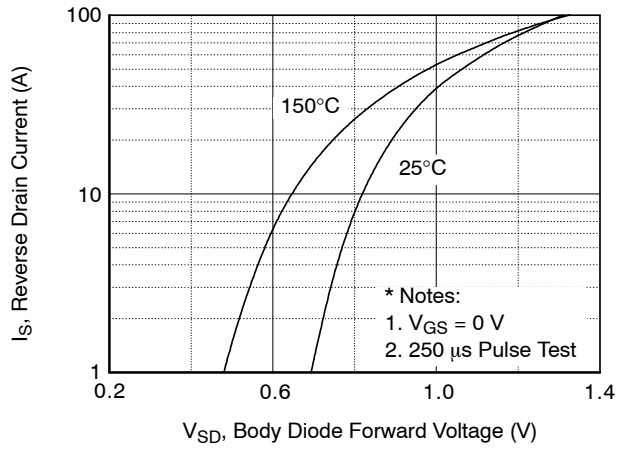

Figure 4. Body Diode Forward Voltage Variation vs. Source Current And Temperature

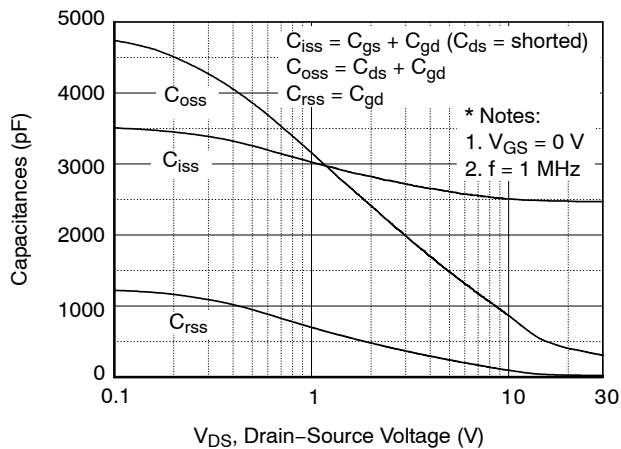

Figure 5. Capacitance Characteristics

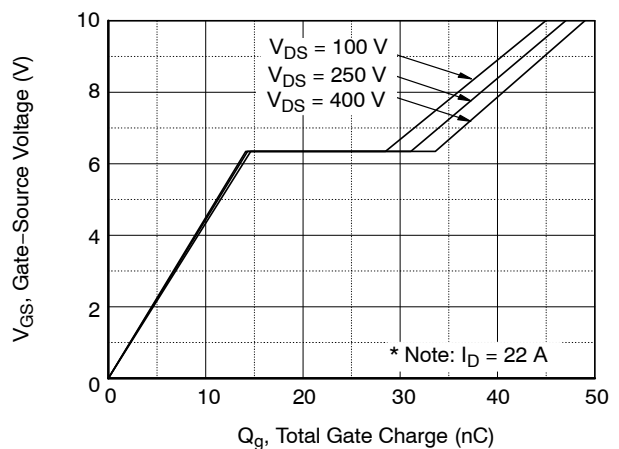

Figure 6. Gate Charge Characteristics

FDP22N50N

TYPICAL PERFORMANCE CHARACTERISTICS (continued)

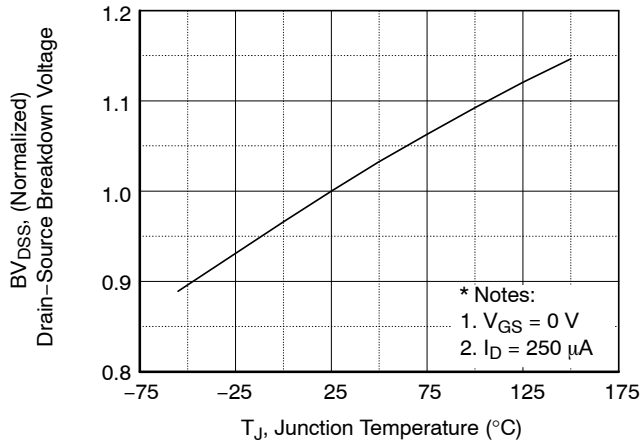

Figure 7. Breakdown Voltage Variation vs. Temperature

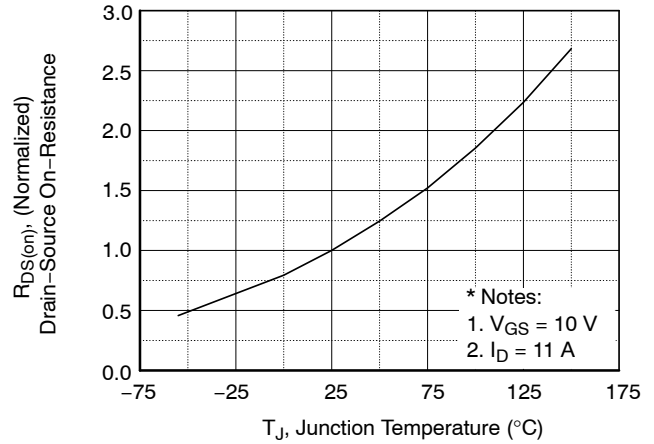

Figure 8. On-Resistance Variation vs. Temperature

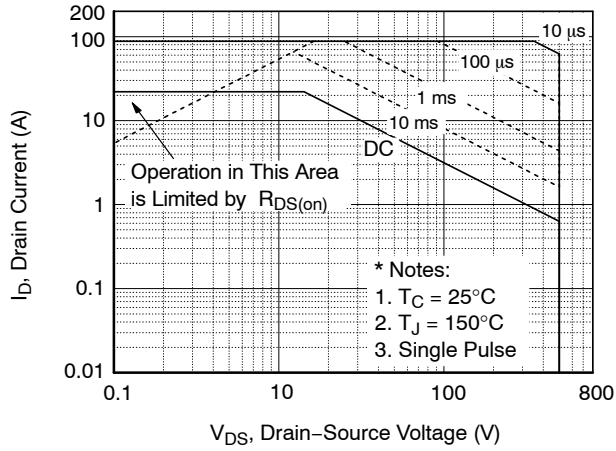

Figure 9. Maximum Safe Operating Area

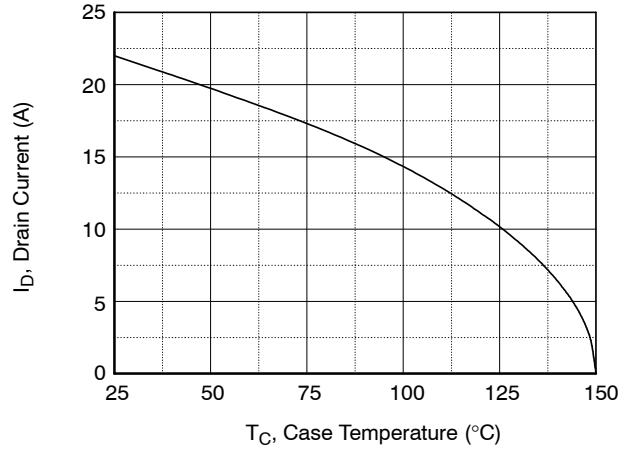

Figure 10. Maximum Drain Current vs. Case Temperature

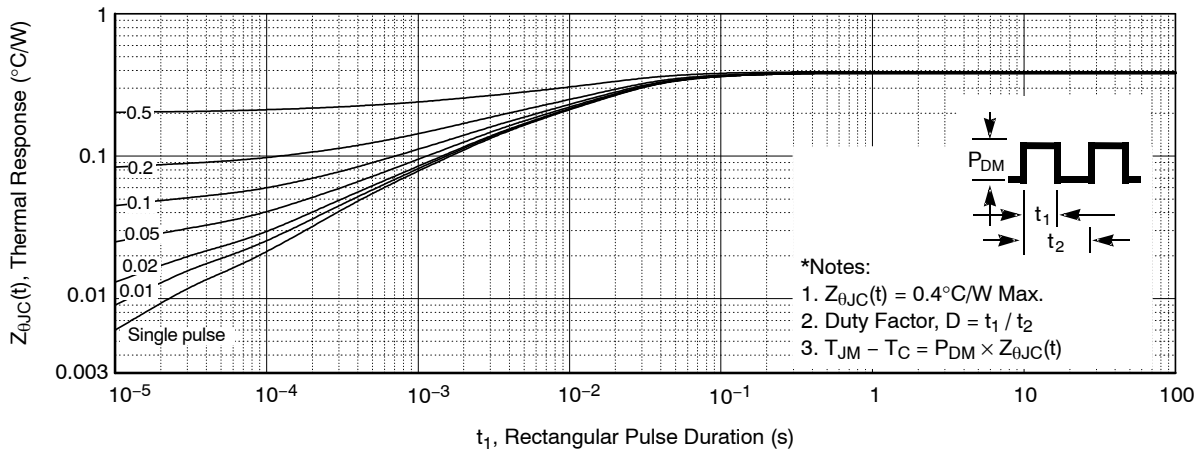

Figure 11. Transient Thermal Response Curve

FDP22N50N

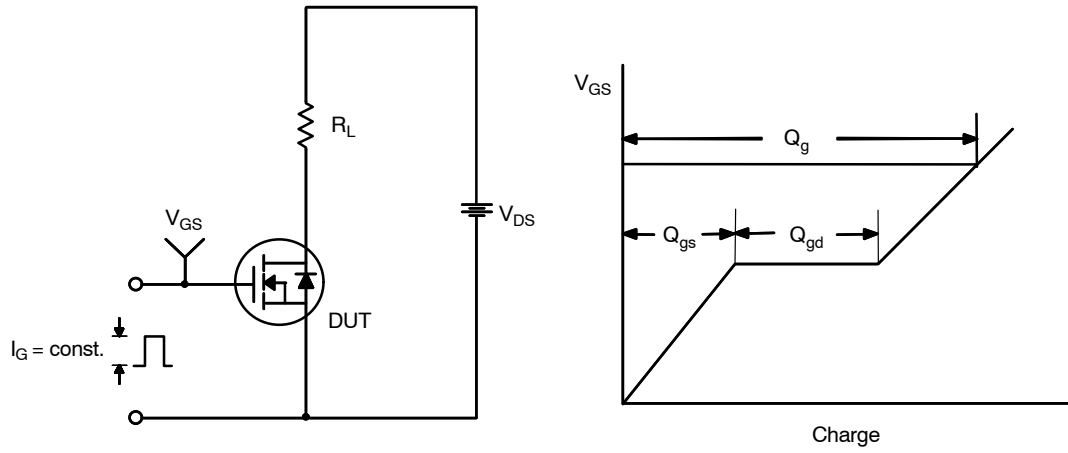

Figure 12. Gate Charge Test Circuit & Waveform

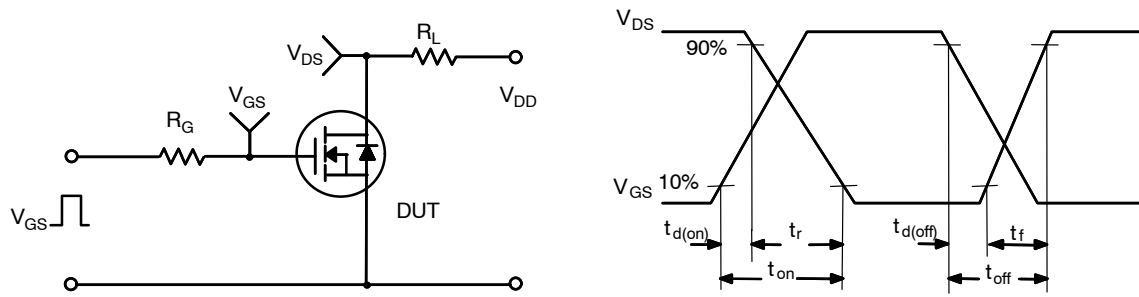

Figure 13. Resistive Switching Test Circuit & Waveforms

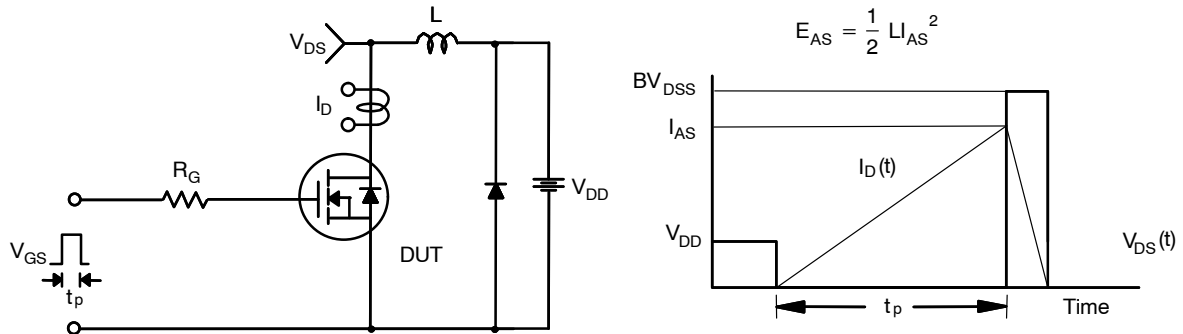

Figure 14. Unclamped Inductive Switching Test Circuit & Waveforms

FDP22N50N

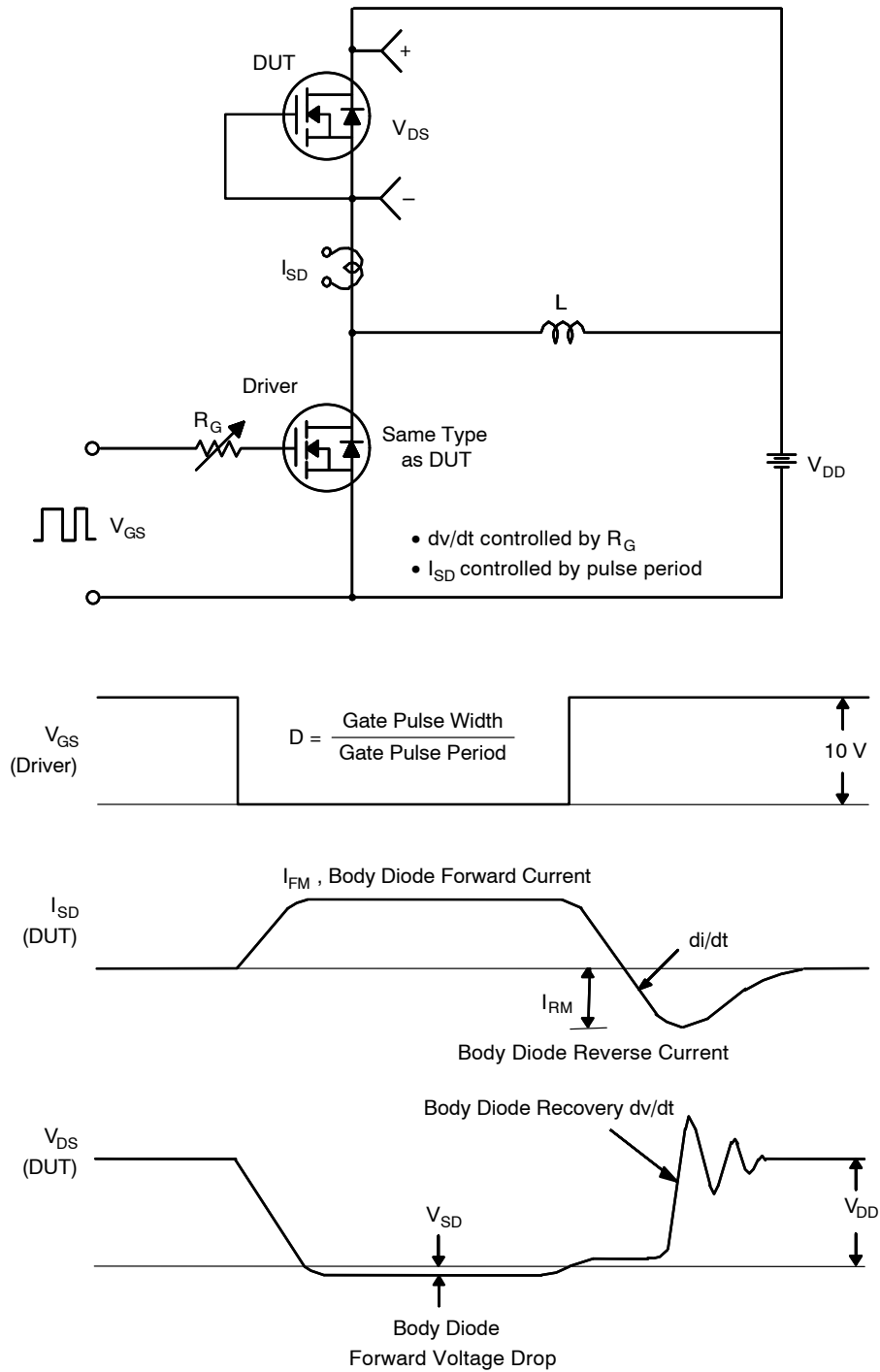
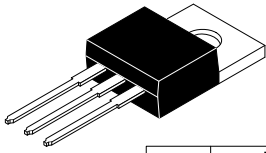

Figure 15. Peak Diode Recovery dv/dt Test Circuit & Waveforms

UniFET is a trademark of Semiconductor Components Industries, LLC dba "onsemi" or its affiliates and/or subsidiaries in the United States and/or other countries.



TO-220-3LD
CASE 340AT
ISSUE B

DATE 08 AUG 2022

| DIM | MILLIMETERS | | |
|-----|--------------|------|-------|
| | MIN. | NOM. | MAX. |
| A | 4.00 | -- | 4.70 |
| A1 | SEE NOTE "F" | | |
| A2 | 2.10 | -- | 2.85 |
| b | 0.55 | -- | 1.00 |
| b2 | 1.10 | -- | 1.62 |
| b4 | 1.42 | -- | 1.62 |
| c | 0.36 | -- | 0.60 |
| D | 13.90 | -- | 16.30 |
| D1 | 8.13 | -- | 9.40 |
| D2 | 11.50 | -- | 14.30 |
| D3 | 15.42 | -- | 16.51 |
| E | 9.65 | -- | 10.67 |
| E1 | 7.59 | -- | 8.65 |
| e | 2.40 | -- | 2.67 |
| H1 | 6.06 | -- | 6.69 |
| L | 12.70 | -- | 14.04 |
| L1 | 2.70 | -- | 4.10 |
| P | 3.50 | -- | 4.00 |
| Q | 2.50 | -- | 3.40 |
| z | 2.13 REF | | |
| z1 | 2.06 REF | | |
| θ | 3° | -- | 5° |

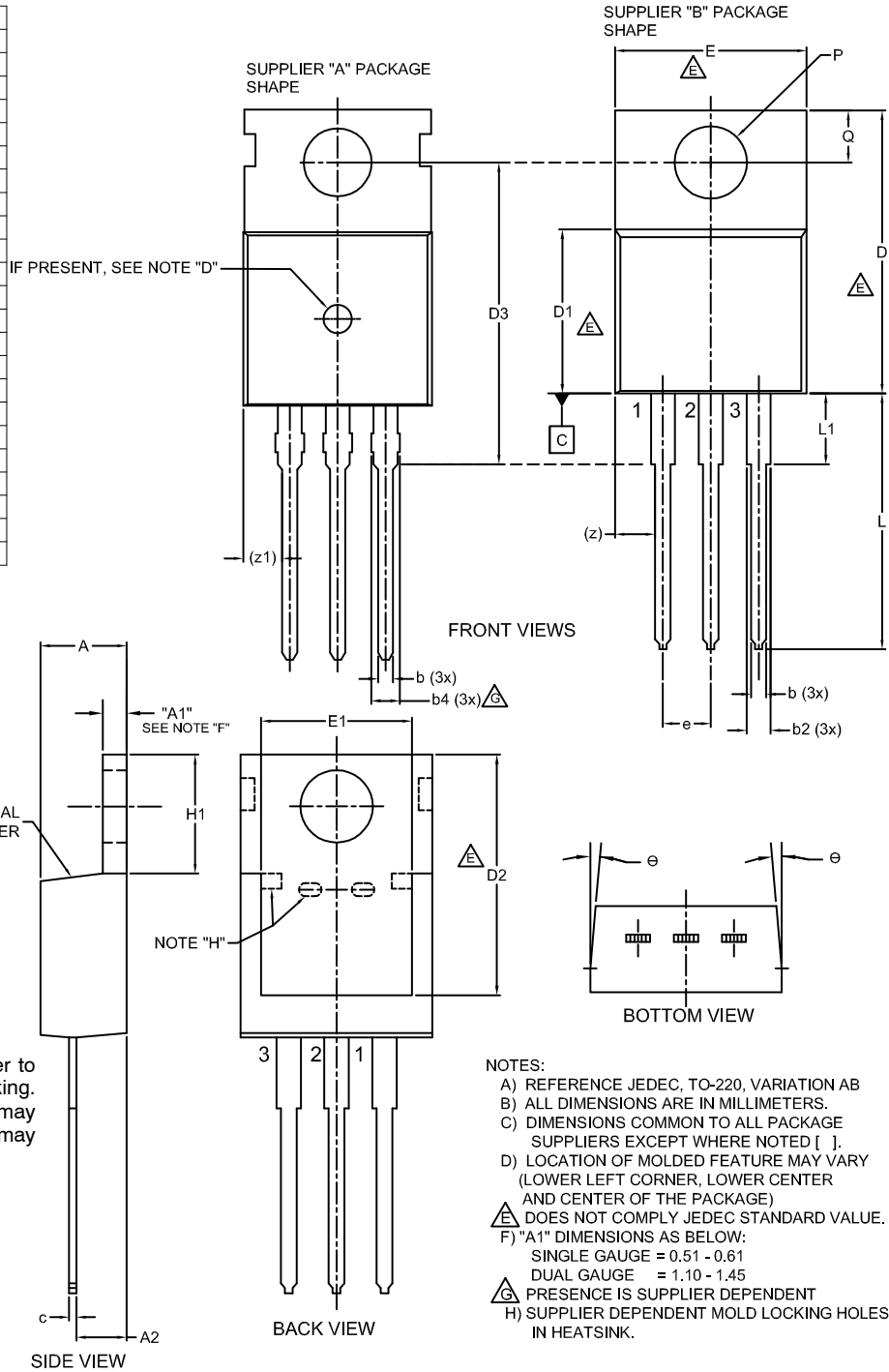

GENERIC MARKING DIAGRAM*



XXXX = Specific Device Code
A = Assembly Location
Y = Year
WW = Work Week
ZZ = Assembly Lot Code

*This information is generic. Please refer to device data sheet for actual part marking. Pb-Free indicator, "G" or microdot "•", may or may not be present. Some products may not follow the Generic Marking.

NOTES:

- A) REFERENCE JEDEC, TO-220, VARIATION AB
- B) ALL DIMENSIONS ARE IN MILLIMETERS.
- C) DIMENSIONS COMMON TO ALL PACKAGE SUPPLIERS EXCEPT WHERE NOTED [].
- D) LOCATION OF MOLDED FEATURE MAY VARY (LOWER LEFT CORNER, LOWER CENTER AND CENTER OF THE PACKAGE)
- ⚠ DOES NOT COMPLY JEDEC STANDARD VALUE.
- F) "A1" DIMENSIONS AS BELOW:
SINGLE GAUGE = 0.51 - 0.61
DUAL GAUGE = 1.10 - 1.45
- ⚠ PRESENCE IS SUPPLIER DEPENDENT
- H) SUPPLIER DEPENDENT MOLD LOCKING HOLES IN HEATSINK.

| | | |
|------------------|-------------|---|
| DOCUMENT NUMBER: | 98AON13818G | Electronic versions are uncontrolled except when accessed directly from the Document Repository. Printed versions are uncontrolled except when stamped "CONTROLLED COPY" in red. |
| DESCRIPTION: | TO-220-3LD | PAGE 1 OF 1 |

onsemi and onsemi are trademarks of Semiconductor Components Industries, LLC dba onsemi or its subsidiaries in the United States and/or other countries. onsemi reserves the right to make changes without further notice to any products herein. onsemi makes no warranty, representation or guarantee regarding the suitability of its products for any particular purpose, nor does onsemi assume any liability arising out of the application or use of any product or circuit, and specifically disclaims any and all liability, including without limitation special, consequential or incidental damages. onsemi does not convey any license under its patent rights nor the rights of others.

onsemi, **Onsemi**, and other names, marks, and brands are registered and/or common law trademarks of Semiconductor Components Industries, LLC dba "**onsemi**" or its affiliates and/or subsidiaries in the United States and/or other countries. **onsemi** owns the rights to a number of patents, trademarks, copyrights, trade secrets, and other intellectual property. A listing of **onsemi**'s product/patent coverage may be accessed at www.onsemi.com/site/pdf/Patent-Marking.pdf. **onsemi** reserves the right to make changes at any time to any products or information herein, without notice. The information herein is provided "as-is" and **onsemi** makes no warranty, representation or guarantee regarding the accuracy of the information, product features, availability, functionality, or suitability of its products for any particular purpose, nor does **onsemi** assume any liability arising out of the application or use of any product or circuit, and specifically disclaims any and all liability, including without limitation special, consequential or incidental damages. Buyer is responsible for its products and applications using **onsemi** products, including compliance with all laws, regulations and safety requirements or standards, regardless of any support or applications information provided by **onsemi**. "Typical" parameters which may be provided in **onsemi** data sheets and/or specifications can and do vary in different applications and actual performance may vary over time. All operating parameters, including "Typicals" must be validated for each customer application by customer's technical experts. **onsemi** does not convey any license under any of its intellectual property rights nor the rights of others. **onsemi** products are not designed, intended, or authorized for use as a critical component in life support systems or any FDA Class 3 medical devices or medical devices with a same or similar classification in a foreign jurisdiction or any devices intended for implantation in the human body. Should Buyer purchase or use **onsemi** products for any such unintended or unauthorized application, Buyer shall indemnify and hold **onsemi** and its officers, employees, subsidiaries, affiliates, and distributors harmless against all claims, costs, damages, and expenses, and reasonable attorney fees arising out of, directly or indirectly, any claim of personal injury or death associated with such unintended or unauthorized use, even if such claim alleges that **onsemi** was negligent regarding the design or manufacture of the part. **onsemi** is an Equal Opportunity/Affirmative Action Employer. This literature is subject to all applicable copyright laws and is not for resale in any manner.

ADDITIONAL INFORMATION

TECHNICAL PUBLICATIONS:

Technical Library: www.onsemi.com/design/resources/technical-documentation
onsemi Website: www.onsemi.com

ONLINE SUPPORT: www.onsemi.com/support

For additional information, please contact your local Sales Representative at www.onsemi.com/support/sales