

MOSFET – N-Channel, UniFET™, FRFET® 500 V, 45 A, 120 mΩ

FDH45N50F

Description

UniFET MOSFET is ON Semiconductor's high voltage MOSFET family based on planar stripe and DMOS technology. This MOSFET is tailored to reduce on-state resistance, and to provide better switching performance and higher avalanche energy strength. The body diode's reverse recovery performance of UniFET FRFET MOSFET has been enhanced by lifetime control. Its t_{rr} is less than 100 nsec and the reverse dv/dt immunity is 15 V/ns while normal planar MOSFETs have over 200 nsec and 4.5 V/nsec respectively. Therefore, it can remove additional component and improve system reliability in certain applications in which the performance of MOSFET's body diode is significant. This device family is suitable for switching power converter applications such as power factor correction (PFC), flat panel display (FPD) TV power, ATX and electronic lamp ballasts.

Features

- $R_{DS(on)} = 105 \text{ m}\Omega$ (Typ.) @ $V_{GS} = 10 \text{ V}$, $I_D = 22.5 \text{ A}$
- Low Gate Charge (Typ. 105 nC)
- Low C_{rss} (Typ. 62 pF)
- 100% Avalanche Tested
- These Devices are Pb-Free, Halogen Free/BFR Free and are RoHS Compliant

Applications

- Lighting
- Uninterruptible Power Supply
- AC-DC Power Supply



ON Semiconductor®

www.onsemi.com

V_{DS}	$R_{DS(on)} \text{ MAX}$	$I_D \text{ MAX}$
500 V	120 mΩ @ 10 V	45 A



N-CHANNEL MOSFET

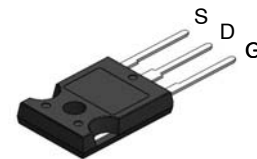

TO-247-3LD
CASE 340CK

MARKING DIAGRAM

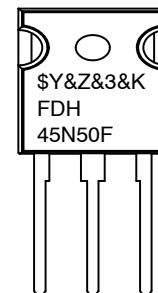

\$Y	= ON Semiconductor Logo
&Z	= Assembly Plant Code
&3	= Numeric Date Code
&K	= Lot Code
FDH45N50F	= Specific Device Code

ORDERING INFORMATION

See detailed ordering and shipping information on page 2 of this data sheet.

FDH45N50F

ABSOLUTE MAXIMUM RATINGS (T_C = 25°C unless otherwise noted)

Symbol	Parameter	FDH45N50F-F133	Unit
V _{DSS}	Drain to Source Voltage	500	V
I _D	Drain Current - -Continuous (T _C = 25°C) -Continuous (T _C = 100°C)	45 28.4	A A
I _{DM}	Drain Current -Pulsed (Note 1)	180	A
V _{GSS}	Gate-Source Voltage	±30	V
E _{AS}	Single Pulsed Avalanche Energy (Note 2)	1868	mJ
I _{AR}	Avalanche Current (Note 1)	45	A
E _{AR}	Repetitive Avalanche Energy (Note 1)	62.5	mJ
dv/dt	Peak Diode Recovery dv/dt (Note 3)	50	V/ns
P _D	Power Dissipation (T _C = 25°C) -Derate Above 25°C	625 5	W W/°C
T _J , T _{STG}	Operating and Storage Temperature Range	-55 to + 150	°C
T _L	Maximum Lead Temperature for Soldering, 1/8" from Case for 5 Second	300	°C

Stresses exceeding those listed in the Maximum Ratings table may damage the device. If any of these limits are exceeded, device functionality should not be assumed, damage may occur and reliability may be affected.

1. Repetitive Rating: Pulse width limited by maximum junction temperature.
2. L = 1.46 mH, I_{AS} = 48 A, V_{DD} = 50 V, R_G = 25 Ω, Starting T_J = 25 °C.
3. I_{SD} ≤ 45 A, di/dt ≤ 200 A/μs, V_{DD} ≤ BV_{DSS}, Starting T_J = 25 °C.

PACKAGE MARKING AND ORDERING INFORMATION

Device Marking	Device	Package	Package Method	Reel Size	Tape Width	Quantity
FDH45N50F-F133	FDH45N50F	TO-247-3	Tube	-	-	30 Units

THERMAL CHARACTERISTICS

Symbol	Parameter	FDH45N50F-F133	Unit
R _{θJC}	Thermal Resistance, Junction to Case, Max.	0.2	°C/W
R _{θJA}	Thermal Resistance, Junction to Ambient, Max.	40	

FDH45N50F

ELECTRICAL CHARACTERISTICS (T_C = 25°C unless otherwise noted)

Symbol	Parameter	Test Condition	Min.	Typ.	Max.	Unit
--------	-----------	----------------	------	------	------	------

OFF CHARACTERISTICS

BV _{DSS}	Drain to Source Breakdown Voltage	I _D = 250 μA, V _{GS} = 0 V	500	–	–	V
ΔBV _{DSS} / ΔT _J	Breakdown Voltage Temperature Coefficient	I _D = 250 μA, Referenced to 25°C	–	0.5	–	V/°C
I _{DSS}	Zero Gate Voltage Drain Current	V _{DS} = 500 V, V _{GS} = 0 V	–	–	25	μA
		V _{DS} = 400 V, T _C = 125°C	–	–	250	μA
I _{GSSF}	Gate–Body Leakage Current, Forward	V _{GS} = 30 V, V _{DS} = 0 V	–	–	100	nA
I _{GSSR}	Gate–Body Leakage Current, Reverse	V _{GS} = –30 V, V _{DS} = 0 V	–	–	–100	nA

ON CHARACTERISTICS

V _{GS(th)}	Gate Threshold Voltage	V _{DS} = V _{GS} , I _D = 250 μA	3	–	5	V
R _{DS(on)}	Static Drain–Source On–Resistance	V _{GS} = 10 V, I _D = 22.5 A	–	0.105	0.12	Ω
g _{FS}	Forward Transconductance	V _{DS} = 40 V, I _D = 22.5 A	–	49	–	S

DYNAMIC CHARACTERISTICS

C _{iss}	Input Capacitance	V _{DS} = 25 V, V _{GS} = 0 V, f = 1 MHz	–	5100	6630	pF
C _{oss}	Output Capacitance		–	790	1030	pF
C _{rss}	Reverse Transfer Capacitance		–	62	–	pF
C _{oss}	Output Capacitance	V _{DS} = 400 V, V _{GS} = 0 V, f = 1 MHz	–	161	–	pF
C _{oss,eff.}	Effective Output Capacitance	V _{DS} = 0 V to 400 V, V _{GS} = 0 V	–	342	–	pF

SWITCHING CHARACTERISTICS

t _{d(on)}	Turn-On Delay Time	V _{DD} = 250 V, I _D = 48 A, V _{GS} = 10 V, R _G = 25 Ω (Note 4)	–	140	290	ns
t _r	Turn-On Rise Time		–	500	1010	ns
t _{d(off)}	Turn-Off Delay Time		–	215	440	ns
t _f	Turn-Off Fall Time		–	245	500	ns
Q _g	Total Gate Charge	V _{DS} = 400 V, I _D = 48 A, V _{GS} = 10 V (Note 4)	–	105	137	nC
Q _{gs}	Gate–Source Charge		–	33	–	nC
Q _{gd}	Gate–Drain Charge		–	45	–	nC

DRAIN-SOURCE DIODE CHARACTERISTICS AND MAXIMUM RATINGS

I _S	Maximum Continuous Drain–Source Diode Forward Current	–	–	45	A	
I _{SM}	Maximum Pulsed Drain–Source Diode Forward Current	–	–	180	A	
V _{SD}	Source to Drain Diode Voltage	V _{GS} = 0 V, I _S = 45 A	–	–	1.4	V
t _{rr}	Reverse Recovery Time	V _{GS} = 0 V, I _S = 45 A, di _F /dt = 100 A/μs	–	188	–	ns
Q _{rr}	Reverse Recovery Charge		–	0.64	–	μC

Product parametric performance is indicated in the Electrical Characteristics for the listed test conditions, unless otherwise noted. Product performance may not be indicated by the Electrical Characteristics if operated under different conditions.

4. Essentially Independent of Operating Temperature Typical Characteristics.

TYPICAL CHARACTERISTICS

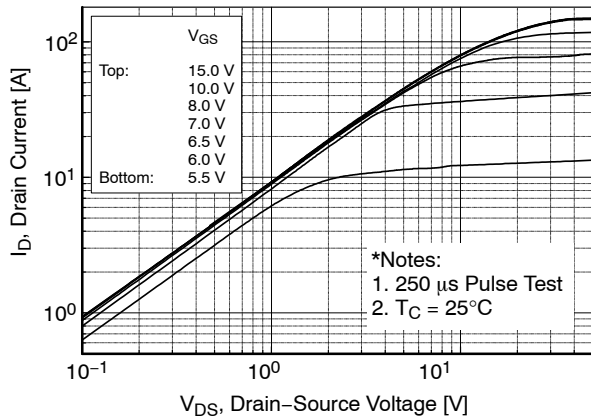

Figure 1. On-Region Characteristics

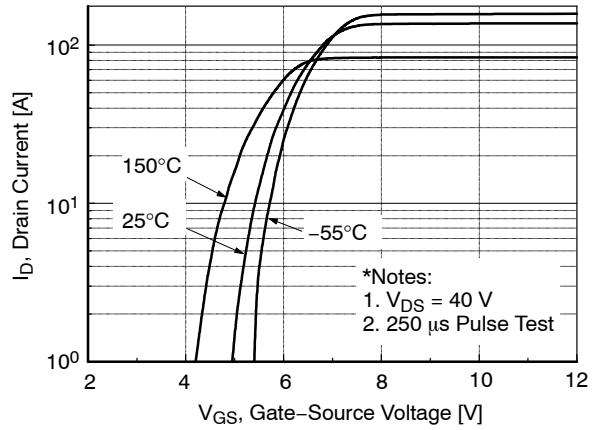

Figure 2. Transfer Characteristics

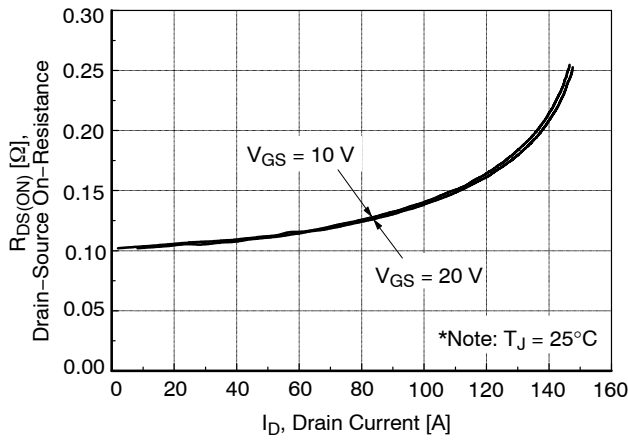

Figure 3. On-Resistance Variation vs. Drain Current and Gate voltage

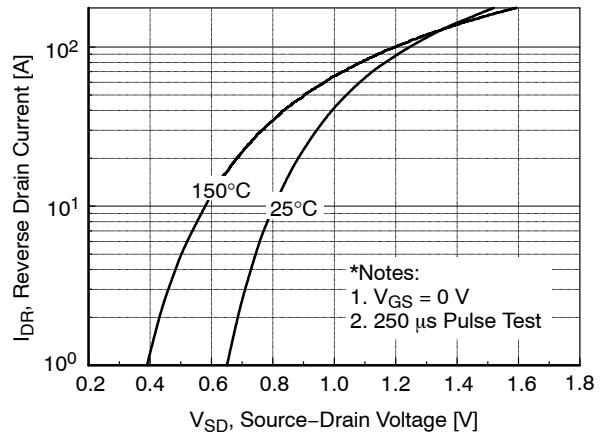

Figure 4. Body Diode Forward Voltage Variation vs. Source Current and Temperature

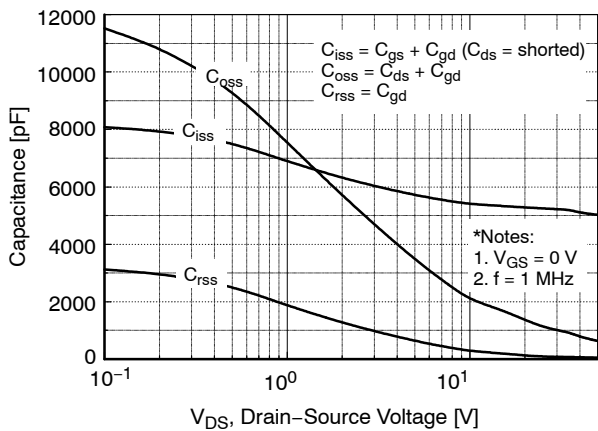

Figure 5. Capacitance Characteristics

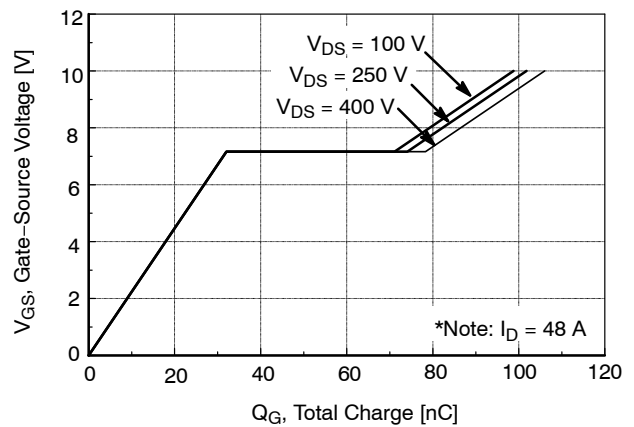

Figure 6. Gate Charge Characteristics

TYPICAL CHARACTERISTICS

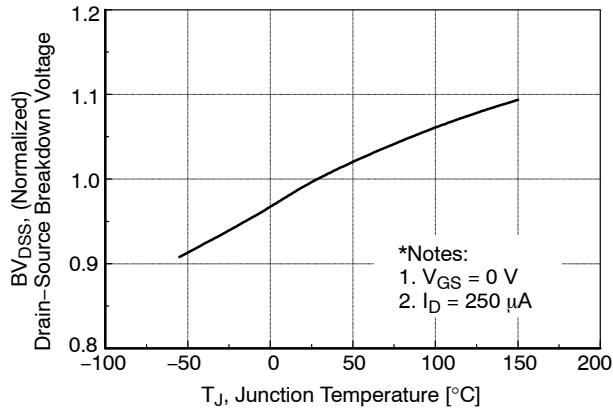

Figure 7. Breakdown Voltage Variation vs. Temperature

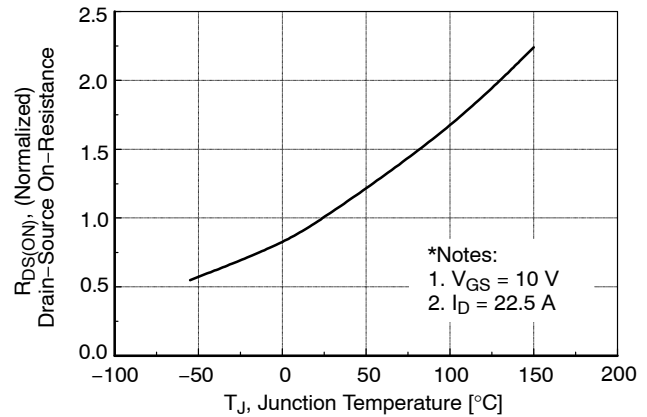

Figure 8. On-Resistance Variation vs. Temperature

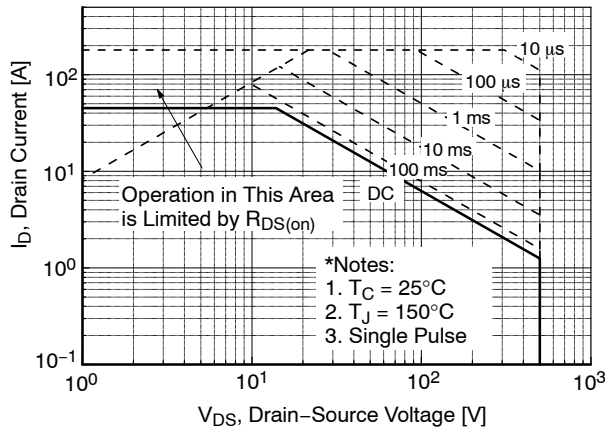

Figure 9. Maximum Safe Operating Area

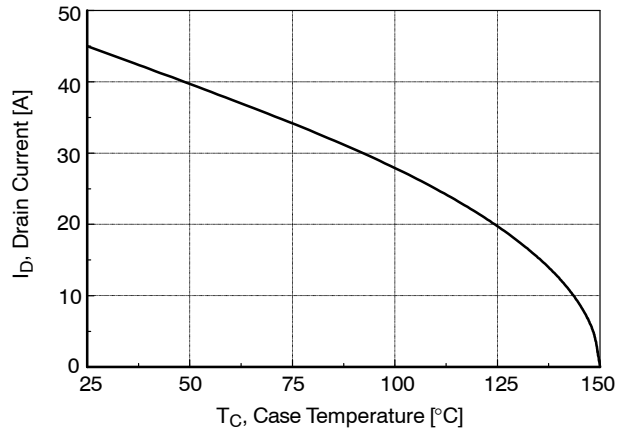

Figure 10. Maximum Drain Current vs. Case Temperature

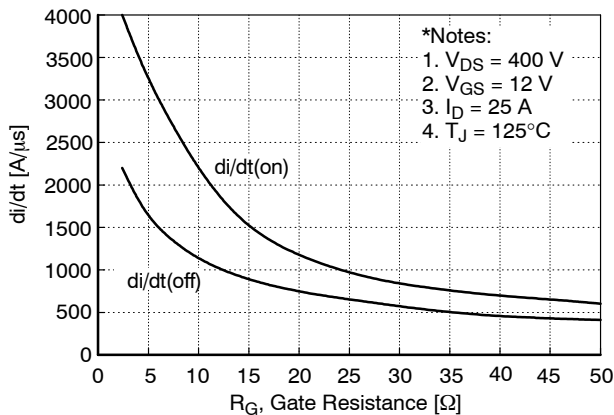

Figure 11. Typical Drain Current Slope vs. Gate Resistance

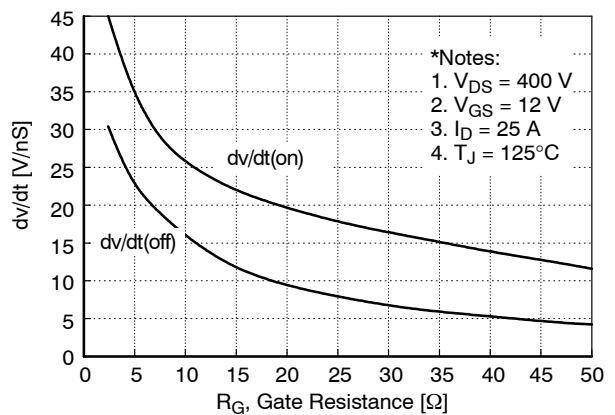

Figure 12. Typical Drain-Source Voltage Slope vs. Gate Resistance

FDH45N50F

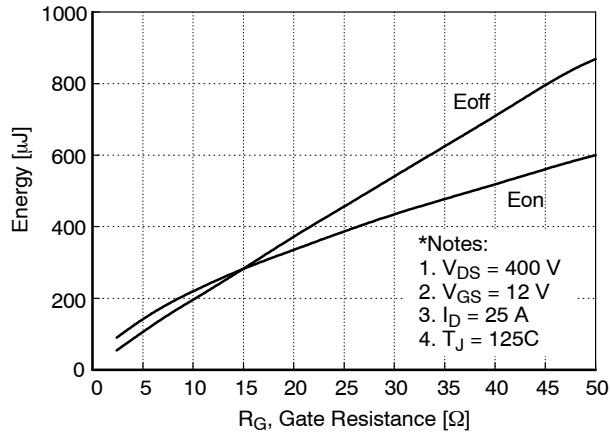

Figure 13. Typical Switching Losses vs. Gate Resistance

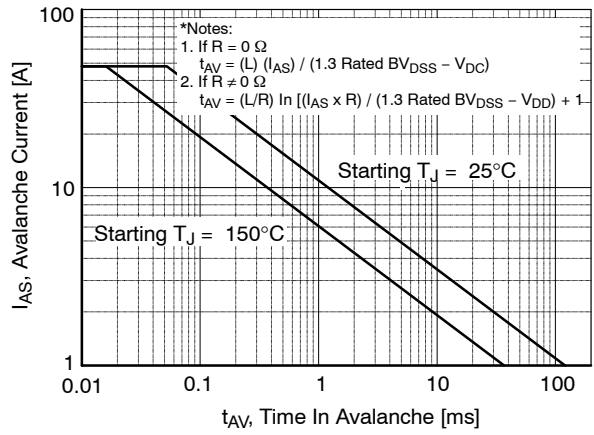

Figure 14. Unclamped Inductive Switching Capability

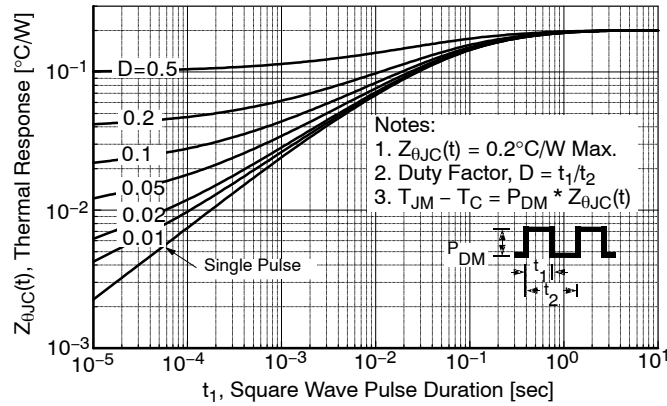

Figure 15. Transient Thermal Resistance Curve

FDH45N50F

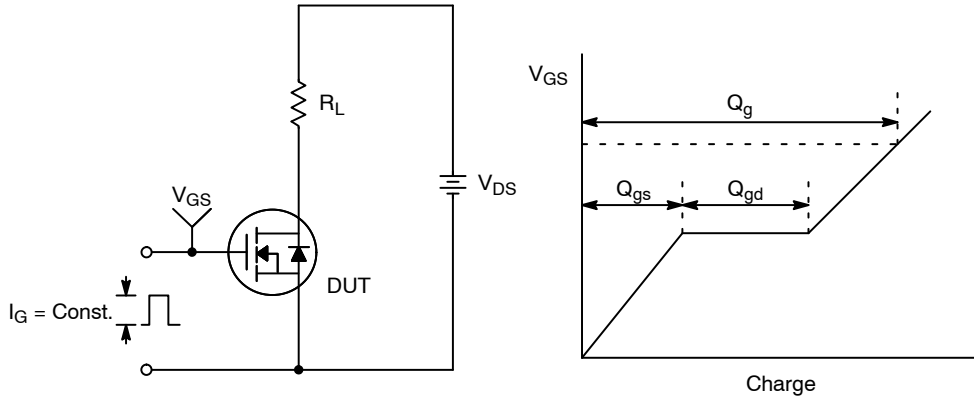

Figure 16. Gate Charge Test Circuit & Waveform



Figure 17. Resistive Switching Test Circuit & Waveforms

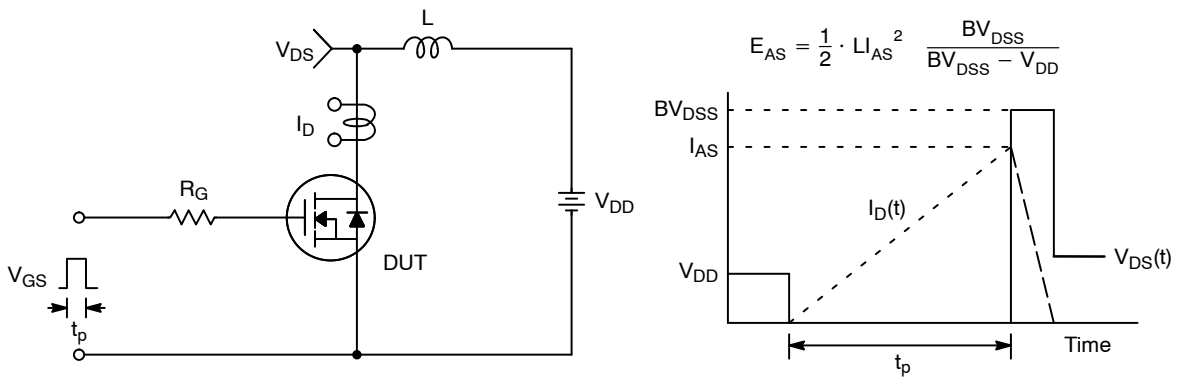

Figure 18. Unclamped Inductive Switching Test Circuit & Waveforms

FDH45N50F

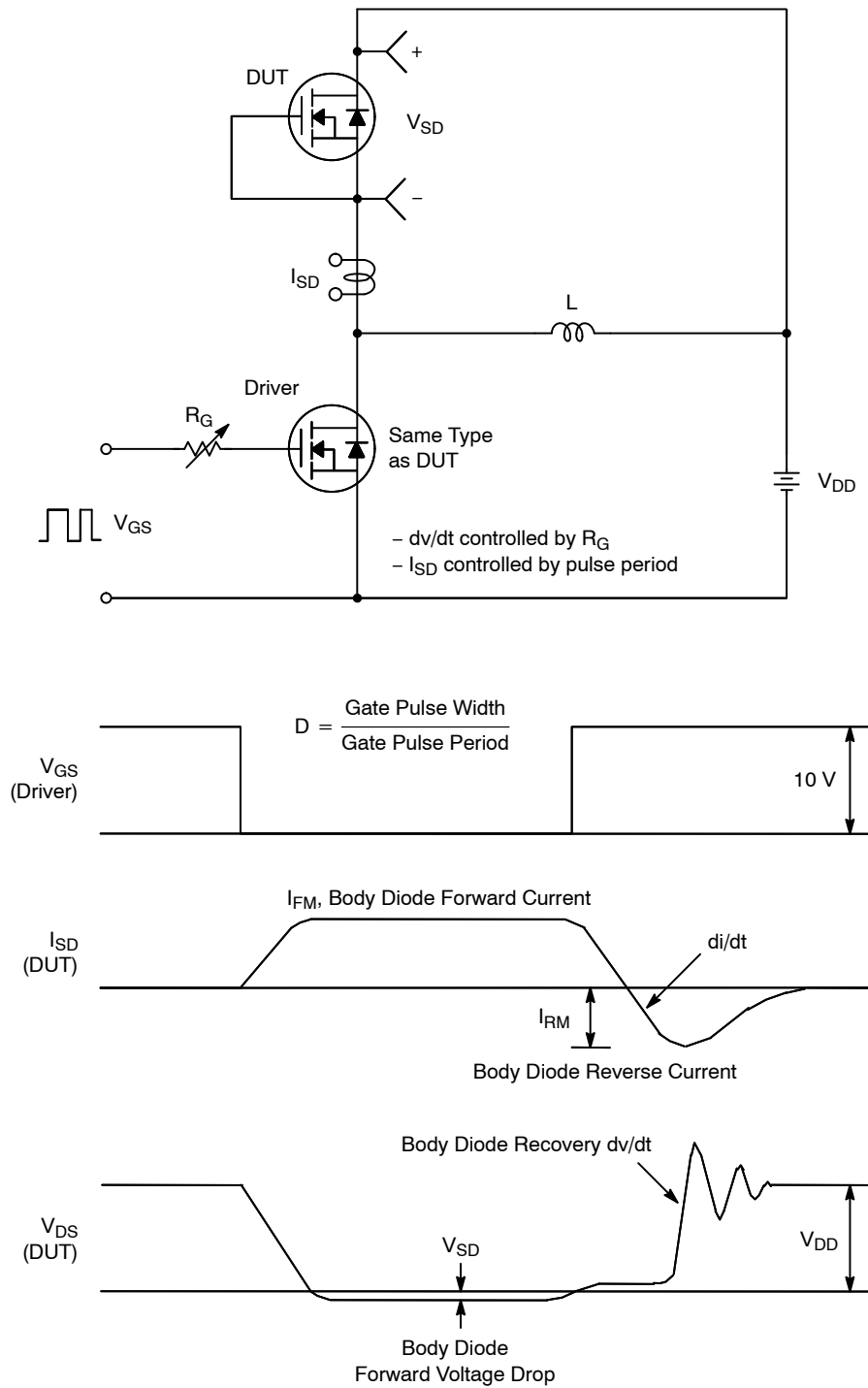

Figure 19. Peak Diode Recovery dv/dt Test Circuit & Waveforms

UniFET is a trademark of Semiconductor Components Industries, LLC (SCILLC) or its subsidiaries in the United States and/or other countries. FRFET is a registered trademark of Semiconductor Components Industries, LLC (SCILLC) or its subsidiaries in the United States and/or other countries.



TO-247-3LD SHORT LEAD
CASE 340CK
ISSUE A

DATE 31 JAN 2019



NOTES: UNLESS OTHERWISE SPECIFIED.

- A. DIMENSIONS ARE EXCLUSIVE OF BURRS, MOLD FLASH, AND TIE BAR EXTRUSIONS.
- B. ALL DIMENSIONS ARE IN MILLIMETERS.
- C. DRAWING CONFORMS TO ASME Y14.5 - 2009.
- D. DIMENSION A1 TO BE MEASURED IN THE REGION DEFINED BY L1.
- E. LEAD FINISH IS UNCONTROLLED IN THE REGION DEFINED BY L1.

GENERIC MARKING DIAGRAM*



XXXX = Specific Device Code
 A = Assembly Location
 Y = Year
 WW = Work Week
 ZZ = Assembly Lot Code

*This information is generic. Please refer to device data sheet for actual part marking. Pb-Free indicator, "G" or microdot "•", may or may not be present. Some products may not follow the Generic Marking.

DIM	MILLIMETERS		
	MIN	NOM	MAX
A	4.58	4.70	4.82
A1	2.20	2.40	2.60
A2	1.40	1.50	1.60
b	1.17	1.26	1.35
b2	1.53	1.65	1.77
b4	2.42	2.54	2.66
c	0.51	0.61	0.71
D	20.32	20.57	20.82
D1	13.08	~	~
D2	0.51	0.93	1.35
E	15.37	15.62	15.87
E1	12.81	~	~
E2	4.96	5.08	5.20
e	~	5.56	~
L	15.75	16.00	16.25
L1	3.69	3.81	3.93
ØP	3.51	3.58	3.65
ØP1	6.60	6.80	7.00
Q	5.34	5.46	5.58
S	5.34	5.46	5.58

DOCUMENT NUMBER:	98AON13851G	Electronic versions are uncontrolled except when accessed directly from the Document Repository. Printed versions are uncontrolled except when stamped "CONTROLLED COPY" in red.
DESCRIPTION:	TO-247-3LD SHORT LEAD	PAGE 1 OF 1

ON Semiconductor and are trademarks of Semiconductor Components Industries, LLC dba ON Semiconductor or its subsidiaries in the United States and/or other countries. ON Semiconductor reserves the right to make changes without further notice to any products herein. ON Semiconductor makes no warranty, representation or guarantee regarding the suitability of its products for any particular purpose, nor does ON Semiconductor assume any liability arising out of the application or use of any product or circuit, and specifically disclaims any and all liability, including without limitation special, consequential or incidental damages. ON Semiconductor does not convey any license under its patent rights nor the rights of others.

onsemi, **Onsemi**, and other names, marks, and brands are registered and/or common law trademarks of Semiconductor Components Industries, LLC dba "**onsemi**" or its affiliates and/or subsidiaries in the United States and/or other countries. **onsemi** owns the rights to a number of patents, trademarks, copyrights, trade secrets, and other intellectual property. A listing of **onsemi**'s product/patent coverage may be accessed at www.onsemi.com/site/pdf/Patent-Marking.pdf. **onsemi** reserves the right to make changes at any time to any products or information herein, without notice. The information herein is provided "as-is" and **onsemi** makes no warranty, representation or guarantee regarding the accuracy of the information, product features, availability, functionality, or suitability of its products for any particular purpose, nor does **onsemi** assume any liability arising out of the application or use of any product or circuit, and specifically disclaims any and all liability, including without limitation special, consequential or incidental damages. Buyer is responsible for its products and applications using **onsemi** products, including compliance with all laws, regulations and safety requirements or standards, regardless of any support or applications information provided by **onsemi**. "Typical" parameters which may be provided in **onsemi** data sheets and/or specifications can and do vary in different applications and actual performance may vary over time. All operating parameters, including "Typicals" must be validated for each customer application by customer's technical experts. **onsemi** does not convey any license under any of its intellectual property rights nor the rights of others. **onsemi** products are not designed, intended, or authorized for use as a critical component in life support systems or any FDA Class 3 medical devices or medical devices with a same or similar classification in a foreign jurisdiction or any devices intended for implantation in the human body. Should Buyer purchase or use **onsemi** products for any such unintended or unauthorized application, Buyer shall indemnify and hold **onsemi** and its officers, employees, subsidiaries, affiliates, and distributors harmless against all claims, costs, damages, and expenses, and reasonable attorney fees arising out of, directly or indirectly, any claim of personal injury or death associated with such unintended or unauthorized use, even if such claim alleges that **onsemi** was negligent regarding the design or manufacture of the part. **onsemi** is an Equal Opportunity/Affirmative Action Employer. This literature is subject to all applicable copyright laws and is not for resale in any manner.

PUBLICATION ORDERING INFORMATION

LITERATURE FULFILLMENT:

Email Requests to: orderlit@onsemi.com

onsemi Website: www.onsemi.com

TECHNICAL SUPPORT

North American Technical Support:

Voice Mail: 1 800-282-9855 Toll Free USA/Canada

Phone: 011 421 33 790 2910

Europe, Middle East and Africa Technical Support:

Phone: 00421 33 790 2910

For additional information, please contact your local Sales Representative