

# MOSFET – Dual, N-Channel, POWERTRENCH®

**30 V, 0.75 A, 0.4 Ω**

## FDG8850NZ

### General Description

This dual N-Channel logic level enhancement mode field effect transistors are produced using onsemi's proprietary, high cell density, DMOS technology. This very high density process is especially tailored to minimize on-state resistance. This device has been designed especially for low voltage applications as a replacement for bipolar digital transistors and small signal MOSFETs. Since bias resistors are not required, this dual digital FET can replace several different digital transistors, with different bias resistor values.

### Features

- Max  $R_{DS(on)}$  = 0.4 Ω at  $V_{GS} = 4.5$  V,  $I_D = 0.75$  A
- Max  $R_{DS(on)}$  = 0.5 Ω at  $V_{GS} = 2.7$  V,  $I_D = 0.67$  A
- Very Low Level Gate Drive Requirements Allowing Operation in 3 V Circuits ( $V_{GS(th)} < 1.5$  V)
- Very Small Package Outline SC-70 6 Lead
- This Device is Pb-Free, Halide Free and is RoHS Compliant

### MOSFET MAXIMUM RATINGS ( $T_A = 25^\circ\text{C}$ unless otherwise noted)

Symbol	Parameter	Ratings	Unit
$V_{DS}$	Drain to Source Voltage	30	V
$V_{GS}$	Gate to Source Voltage	$\pm 12$	V
$I_D$	Drain Current	Continuous	0.75
		Pulsed	2.2
$P_D$	Power Dissipation	(Note 1a)	0.36
		(Note 1b)	0.30
$T_J, T_{STG}$	Operating and Storage Junction Temperature Range	-55 to +150	$^\circ\text{C}$

Stresses exceeding those listed in the Maximum Ratings table may damage the device. If any of these limits are exceeded, device functionality should not be assumed, damage may occur and reliability may be affected.

### THERMAL CHARACTERISTICS

Symbol	Parameter	Ratings	Unit
$R_{\theta JA}$	Thermal Resistance, Junction to Ambient Single Operation (Note 1a)	350	$^\circ\text{C}/\text{W}$
$R_{\theta JA}$	Thermal Resistance, Junction to Ambient Single Operation (Note 1b)	415	

$V_{DS}$	$R_{DS(on)}$ MAX	$I_D$ MAX
30 V	0.4 Ω @ 4.5 V	0.75 A
	0.5 Ω @ 2.7 V	

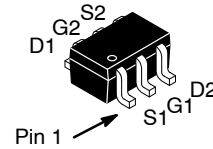

SC-88 (SC-70 6 Lead), 1.25 x 2  
CASE 419AD-01

### MARKING DIAGRAM

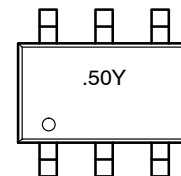

.50 = Specific Device Code  
Y = 1-Digit Weekly Date Code

### PIN ASSIGNMENT

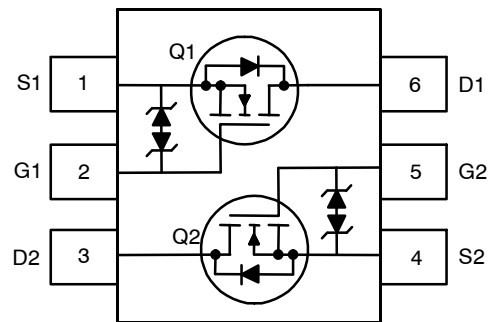

NOTE: The pinouts are symmetrical; pin 1 and 4 are interchangeable. Units inside the carrier can be of either orientation and will not affect the functionality of the device.

### ORDERING INFORMATION

Device	Package	Shipping†
FDG8850NZ	SC-88 (SC-70 6 Lead), 1.25 x 2	3000 / Tape & Reel

For information on tape and reel specifications, including part orientation and tape sizes, please refer to our Tape and Reel Packaging Specification Brochure, [BRD8011/D](#).

# FDG8850NZ

## ELECTRICAL CHARACTERISTICS (T<sub>J</sub> = 25°C unless otherwise noted)

Symbol	Parameter	Test Conditions	Min.	Typ.	Max.	Unit
--------	-----------	-----------------	------	------	------	------

### OFF CHARACTERISTICS

BV <sub>DSS</sub>	Drain to Source Breakdown Voltage	I <sub>D</sub> = 250 μA, V <sub>GS</sub> = 0 V	30	–	–	V
$\frac{\Delta BV_{DSS}}{\Delta T_J}$	Breakdown Voltage Temperature Coefficient	I <sub>D</sub> = 250 μA, referenced to 25°C	–	25	–	mV/°C
I <sub>DSS</sub>	Zero Gate Voltage Drain Current	V <sub>DS</sub> = 24 V, V <sub>GS</sub> = 0 V	–	–	1	μA
I <sub>GSS</sub>	Gate to Source Leakage Current	V <sub>GS</sub> = ±12 V, V <sub>DS</sub> = 0 V	–	–	±10	μA

### ON CHARACTERISTICS

V <sub>GS(th)</sub>	Gate to Source Threshold Voltage	V <sub>GS</sub> = V <sub>DS</sub> , I <sub>D</sub> = 250 μA	0.65	1.0	1.5	V
$\frac{\Delta V_{GS(th)}}{\Delta T_J}$	Gate to Source Threshold Voltage Temperature Coefficient	I <sub>D</sub> = 250 μA, referenced to 25°C	–	–3.0	–	mV/°C
R <sub>DS(on)</sub>	Static Drain to Source On Resistance	V <sub>GS</sub> = 4.5 V, I <sub>D</sub> = 0.75 A	–	0.25	0.4	Ω
		V <sub>GS</sub> = 2.7 V, I <sub>D</sub> = 0.67 A	–	0.29	0.5	
		V <sub>GS</sub> = 4.5 V, I <sub>D</sub> = 0.75 A, T <sub>J</sub> = 125°C	–	0.36	0.6	
g <sub>FS</sub>	Forward Transconductance	V <sub>DS</sub> = 5 V, I <sub>D</sub> = 0.75 A	–	3	–	S

### DYNAMIC CHARACTERISTICS

C <sub>iss</sub>	Input Capacitance	V <sub>DS</sub> = 10 V, V <sub>GS</sub> = 0 V, f = 1 MHz	–	90	120	pF
C <sub>oss</sub>	Output Capacitance		–	20	30	pF
C <sub>rss</sub>	Reverse Transfer Capacitance		–	15	25	pF

### SWITCHING CHARACTERISTICS (Note 2)

t <sub>d(on)</sub>	Turn-On Delay Time	V <sub>DD</sub> = 5 V, I <sub>D</sub> = 0.5 A, V <sub>GS</sub> = 4.5 V, R <sub>GEN</sub> = 6 Ω	–	4	10	ns
t <sub>r</sub>	Rise Time		–	1	10	ns
t <sub>d(off)</sub>	Turn-Off Delay Time		–	9	18	ns
t <sub>f</sub>	Fall Time		–	1	10	ns
Q <sub>g(TOT)</sub>	Total Gate Charge	V <sub>GS</sub> = 4.5 V, V <sub>DD</sub> = 5 V, I <sub>D</sub> = 0.75 A	–	1.03	1.44	nC
Q <sub>gs</sub>	Gate to Source Charge		–	0.29	–	nC
Q <sub>gd</sub>	Gate to Drain "Miller" Charge		–	0.17	–	nC

### DRAIN-SOURCE DIODE CHARACTERISTICS AND MAXIMUM RATINGS

I <sub>S</sub>	Maximum Continuous Drain-Source Diode Forward Current	–	–	0.3	A	
V <sub>SD</sub>	Source to Drain Diode Forward Voltage	V <sub>GS</sub> = 0 V, I <sub>S</sub> = 0.3 A (Note 2)	–	0.76	1.2	V

Product parametric performance is indicated in the Electrical Characteristics for the listed test conditions, unless otherwise noted. Product performance may not be indicated by the Electrical Characteristics if operated under different conditions.

#### NOTES:

- R<sub>θJA</sub> is the sum of the junction-to-case and case-to-ambient thermal resistance where the case thermal reference is defined as the solder mounting surface of the drain pins. R<sub>θJC</sub> is guaranteed by design while R<sub>θCA</sub> is determined by the user's board design.

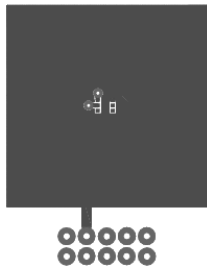

a. 350°C/W when mounted on a 1 in<sup>2</sup> pad of 2 oz copper

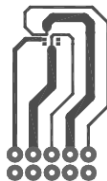

b. 415°C/W when mounted on a minimum pad of 2 oz copper

- Pulse Test: Pulse Width < 300 μs, Duty cycle < 2.0%.

# FDG8850NZ

## TYPICAL CHARACTERISTICS

( $T_J = 25^\circ\text{C}$  unless otherwise noted)

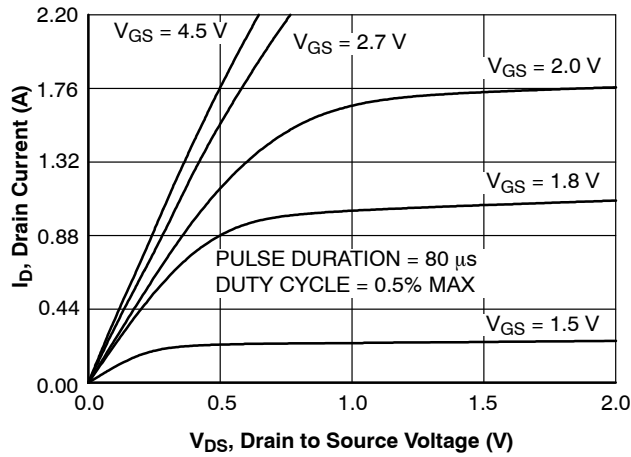

Figure 1. On-Region Characteristics

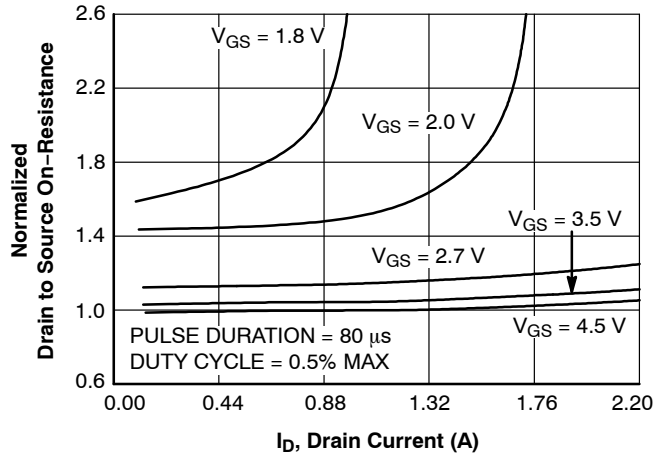

Figure 2. Normalized On-Resistance vs. Drain Current and Gate Voltage

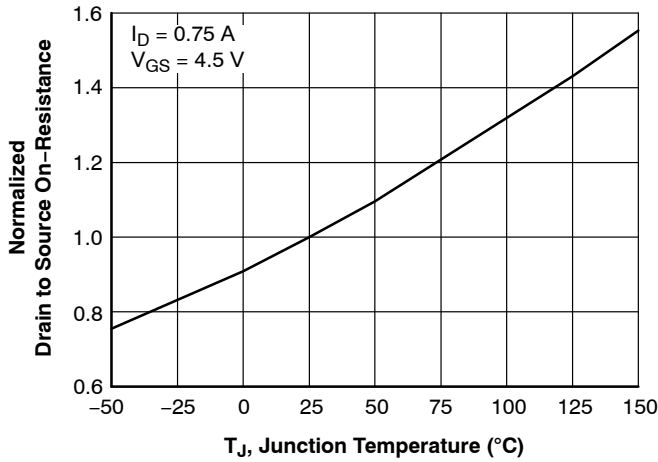

Figure 3. Normalized On-Resistance vs. Junction Temperature

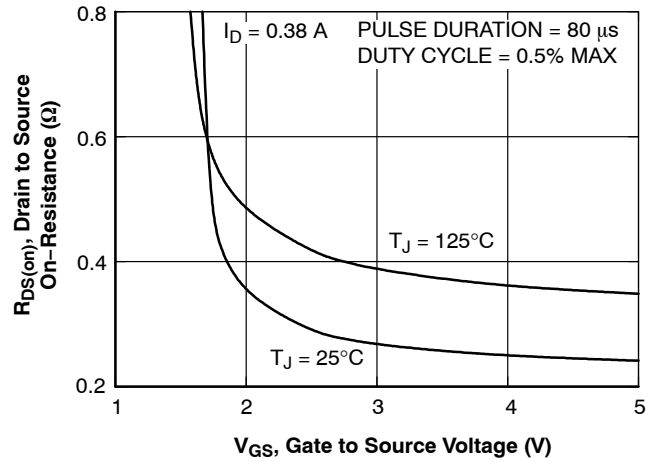

Figure 4. On-Resistance vs. Gate to Source Voltage

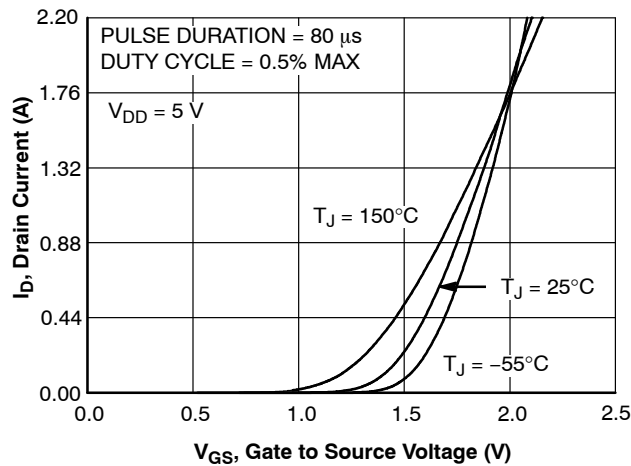

Figure 5. Transfer Characteristics

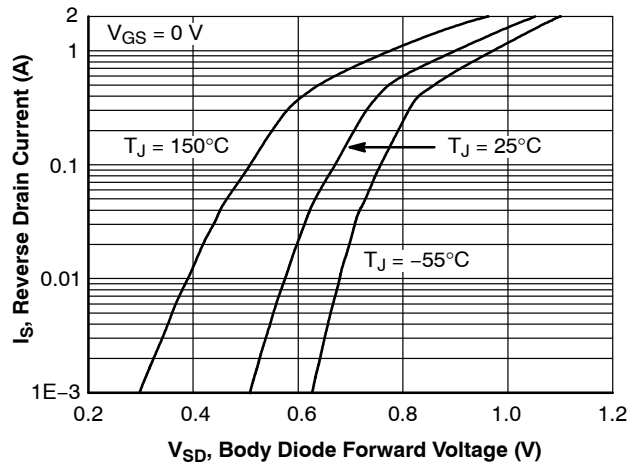

Figure 6. Source to Drain Diode Forward Voltage vs. Source Current

# FDG8850NZ

## TYPICAL CHARACTERISTICS (continued)

( $T_J = 25^\circ\text{C}$  unless otherwise noted)

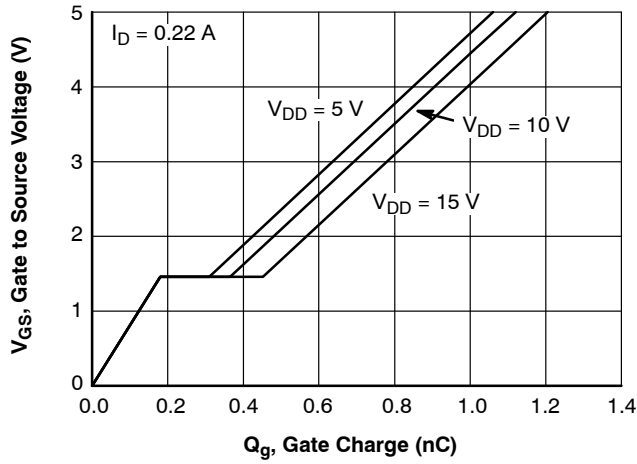

Figure 7. Gate Charge Characteristics

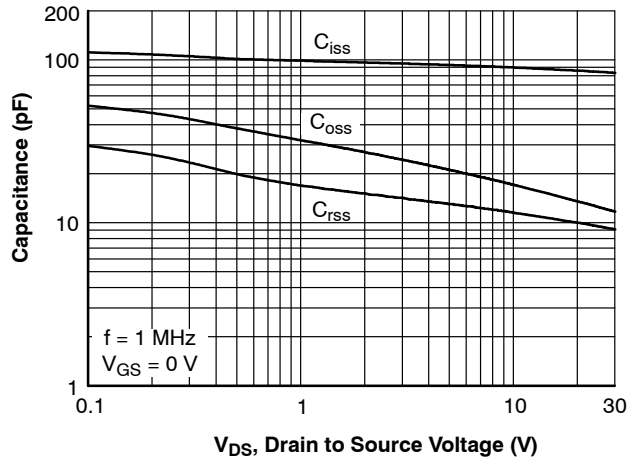

Figure 8. Capacitance vs. Drain to Source Voltage

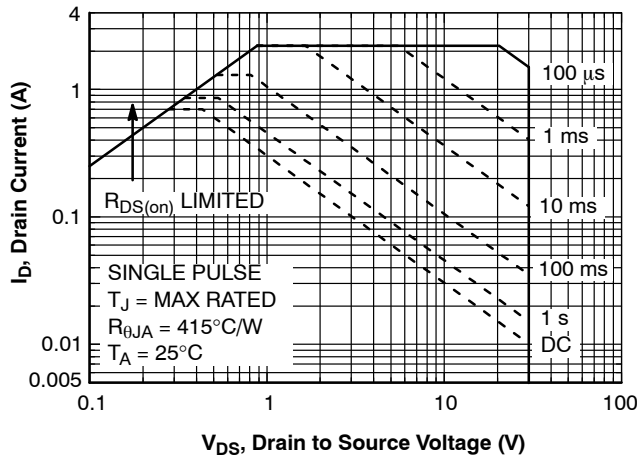

Figure 9. Forward Bias Safe Operating Area

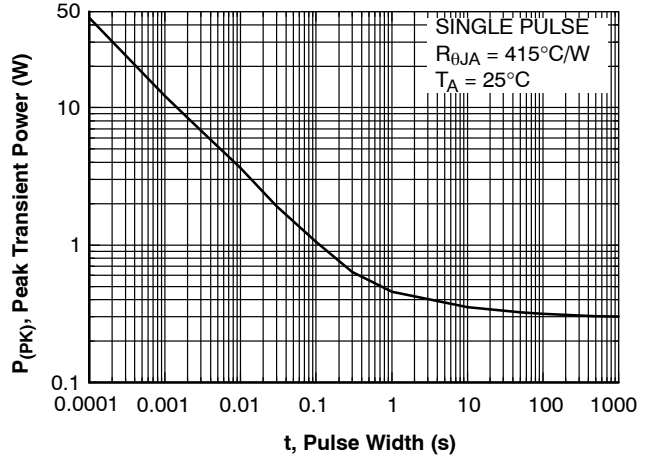

Figure 10. Single Pulse Maximum Power Dissipation

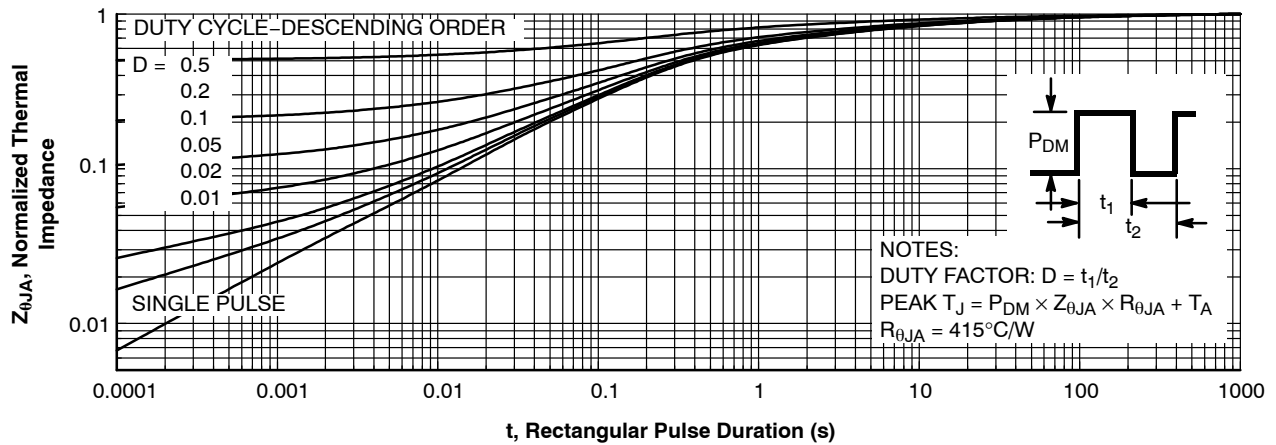
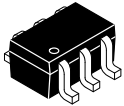

Figure 11. Transient Thermal Response Curve

POWERTRENCH is a registered trademark of Semiconductor Components Industries, LLC dba "onsemi" or its affiliates and/or subsidiaries in the United States and/or other countries.

**MECHANICAL CASE OUTLINE**  
**PACKAGE DIMENSIONS**



1

**SC-88 (SC-70 6 Lead), 1.25x2**  
**CASE 419AD**  
**ISSUE A**

DATE 07 JUL 2010

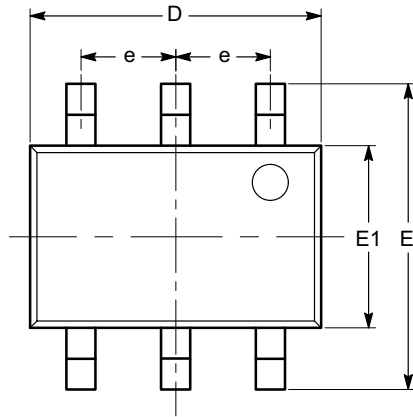

**TOP VIEW**

SYMBOL	MIN	NOM	MAX
A	0.80		1.10
A1	0.00		0.10
A2	0.80		1.00
b	0.15		0.30
c	0.10		0.18
D	1.80	2.00	2.20
E	1.80	2.10	2.40
E1	1.15	1.25	1.35
e	0.65 BSC		
L	0.26	0.36	0.46
L1	0.42 REF		
L2	0.15 BSC		
$\theta$	0°		8°
$\theta_1$	4°		10°

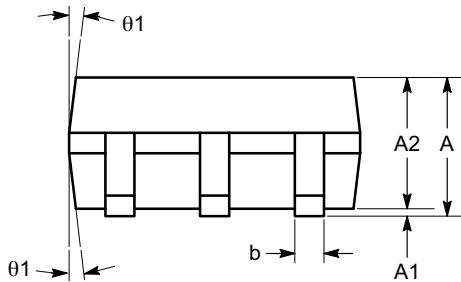

**SIDE VIEW**

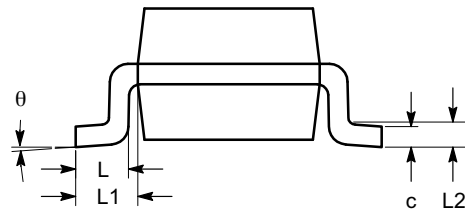

**END VIEW**

**Notes:**

- (1) All dimensions are in millimeters. Angles in degrees.
- (2) Complies with JEDEC MO-203.

<b>DOCUMENT NUMBER:</b>	<b>98AON34266E</b>	Electronic versions are uncontrolled except when accessed directly from the Document Repository. Printed versions are uncontrolled except when stamped "CONTROLLED COPY" in red.
<b>DESCRIPTION:</b>	<b>SC-88 (SC-70 6 LEAD), 1.25X2</b>	<b>PAGE 1 OF 1</b>

onsemi and onsemi are trademarks of Semiconductor Components Industries, LLC dba onsemi or its subsidiaries in the United States and/or other countries. onsemi reserves the right to make changes without further notice to any products herein. onsemi makes no warranty, representation or guarantee regarding the suitability of its products for any particular purpose, nor does onsemi assume any liability arising out of the application or use of any product or circuit, and specifically disclaims any and all liability, including without limitation special, consequential or incidental damages. onsemi does not convey any license under its patent rights nor the rights of others.

**onsemi**, **Onsemi**, and other names, marks, and brands are registered and/or common law trademarks of Semiconductor Components Industries, LLC dba "**onsemi**" or its affiliates and/or subsidiaries in the United States and/or other countries. **onsemi** owns the rights to a number of patents, trademarks, copyrights, trade secrets, and other intellectual property. A listing of **onsemi**'s product/patent coverage may be accessed at [www.onsemi.com/site/pdf/Patent-Marking.pdf](http://www.onsemi.com/site/pdf/Patent-Marking.pdf). **onsemi** reserves the right to make changes at any time to any products or information herein, without notice. The information herein is provided "as-is" and **onsemi** makes no warranty, representation or guarantee regarding the accuracy of the information, product features, availability, functionality, or suitability of its products for any particular purpose, nor does **onsemi** assume any liability arising out of the application or use of any product or circuit, and specifically disclaims any and all liability, including without limitation special, consequential or incidental damages. Buyer is responsible for its products and applications using **onsemi** products, including compliance with all laws, regulations and safety requirements or standards, regardless of any support or applications information provided by **onsemi**. "Typical" parameters which may be provided in **onsemi** data sheets and/or specifications can and do vary in different applications and actual performance may vary over time. All operating parameters, including "Typicals" must be validated for each customer application by customer's technical experts. **onsemi** does not convey any license under any of its intellectual property rights nor the rights of others. **onsemi** products are not designed, intended, or authorized for use as a critical component in life support systems or any FDA Class 3 medical devices or medical devices with a same or similar classification in a foreign jurisdiction or any devices intended for implantation in the human body. Should Buyer purchase or use **onsemi** products for any such unintended or unauthorized application, Buyer shall indemnify and hold **onsemi** and its officers, employees, subsidiaries, affiliates, and distributors harmless against all claims, costs, damages, and expenses, and reasonable attorney fees arising out of, directly or indirectly, any claim of personal injury or death associated with such unintended or unauthorized use, even if such claim alleges that **onsemi** was negligent regarding the design or manufacture of the part. **onsemi** is an Equal Opportunity/Affirmative Action Employer. This literature is subject to all applicable copyright laws and is not for resale in any manner.

---

## ADDITIONAL INFORMATION

### TECHNICAL PUBLICATIONS:

Technical Library: [www.onsemi.com/design/resources/technical-documentation](http://www.onsemi.com/design/resources/technical-documentation)  
onsemi Website: [www.onsemi.com](http://www.onsemi.com)

### ONLINE SUPPORT: [www.onsemi.com/support](http://www.onsemi.com/support)

For additional information, please contact your local Sales Representative at [www.onsemi.com/support/sales](http://www.onsemi.com/support/sales)