

# MOSFET – N-Channel, POWERTRENCH® 60 V

## FDD5612

### General Description

This N-Channel MOSFET has been designed specifically to improve the overall efficiency of DC/DC converters using either synchronous or conventional switching PWM controllers.

These MOSFETs feature faster switching and lower gate charge than other MOSFETs with comparable  $R_{DS(ON)}$  specifications. The result is a MOSFET that is easy and safer to drive (even at very high frequencies), and DC/DC power supply designs with higher overall efficiency.

### Features

- 18 A, 60 V
  - ♦  $R_{DS(ON)} = 55 \text{ m}\Omega @ V_{GS} = 10 \text{ V}$
  - ♦  $R_{DS(ON)} = 64 \text{ m}\Omega @ V_{GS} = 6 \text{ V}$
- Optimized for Use in High Frequency DC/DC Converters
- Low Gate Charge
- Very Fast Switching
- This Device is Pb-Free and are RoHS Compliant



**ON Semiconductor®**

[www.onsemi.com](http://www.onsemi.com)

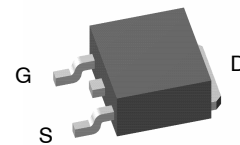
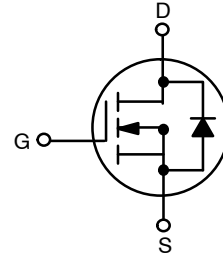

**DPAK3 (TO-252 3 LD)  
CASE 369AS**

### MARKING DIAGRAM

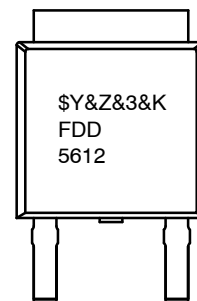

|         |                         |
|---------|-------------------------|
| \$Y     | = ON Semiconductor Logo |
| &Z      | = Assembly Plant Code   |
| &3      | = Numeric Date Code     |
| &K      | = Lot Code              |
| FDD5612 | = Specific Device Code  |

### ORDERING INFORMATION

See detailed ordering and shipping information on page 2 of this data sheet.

# FDD5612

## ABSOLUTE MAXIMUM RATINGS (T<sub>A</sub> = 25°C, Unless otherwise noted)

| Symbol                            | Parameter  | Ratings                         | Units |   |
|-----------------------------------|--|---------------------------------|-------|---|
| V <sub>DSS</sub>                  | Drain–Source Voltage                             | 60                              | V     |   |
| V <sub>GSS</sub>                  | Gate–Source Voltage                              | ±20                             | V     |   |
| I <sub>D</sub>                    | Drain Current – Continuous                       | T <sub>C</sub> = 25°C           | 18    | A |
|                                   |  | T <sub>C</sub> = 100°C          | 13    |   |
|                                   |  | T <sub>A</sub> = 25°C (Note 1a) | 5.4   |   |
|                                   |  | T <sub>A</sub> = 25°C (Note 1b) | 3.5   |   |
|                                   | Drain Current – Pulsed                           | 100                             |       |   |
| P <sub>D</sub>                    | Maximum Power Dissipation                        | T <sub>C</sub> = 25°C           | 42    | W |
|                                   |  | T <sub>C</sub> = 100°C          | 21    |   |
|                                   |  | T <sub>A</sub> = 25°C (Note 1a) | 3.8   |   |
|                                   |  | T <sub>A</sub> = 25°C (Note 1b) | 1.6   |   |
| T <sub>J</sub> , T <sub>STG</sub> | Operating and Storage Junction Temperature Range | –55 to +175                     | °C    |   |

Stresses exceeding those listed in the Maximum Ratings table may damage the device. If any of these limits are exceeded, device functionality should not be assumed, damage may occur and reliability may be affected.

## THERMAL CHARACTERISTICS

| Symbol           | Parameter   | Ratings | Unit |
|------------------|---|---------|------|
| R <sub>θJC</sub> | Thermal Resistance, Junction–to–Case              | 3.5     | °C/W |
| R <sub>θJA</sub> | Thermal Resistance, Junction–to–Ambient (Note 1a) | 40      | °C/W |
| R <sub>θJA</sub> | Thermal Resistance, Junction–to–Ambient (Note 1b) | 96      | °C/W |

## PACKAGE MARKING AND ORDERING INFORMATION

| Part Number | Device  | Reel Size | Tape Width | Quantity   |
|-------------|---------|-----------|------------|------------|
| FDD5612     | FDD5612 | 13"       | 16 mm      | 2500 Units |

## ELECTRICAL CHARACTERISTICS (T<sub>A</sub> = 25°C unless otherwise noted)

| Symbol | Parameter | Test Conditions | Min | Typ | Max | Unit |
|--------|-----------|-----------------|-----|-----|-----|------|
|--------|-----------|-----------------|-----|-----|-----|------|

### DRAIN–SOURCE AVALANCHE RATINGS (Note 1)

|                  |  |  |  |  |     |    |
|------------------|--|--|--|--|-----|----|
| W <sub>DSS</sub> | Single Pulse Drain–Source Avalanche Energy | V <sub>DD</sub> = 30 V, I <sub>D</sub> = 5.4 A |  |  | 90  | mJ |
| I <sub>AR</sub>  | Maximum Drain–Source Avalanche Current     |  |  |  | 5.4 | A  |

### OFF CHARACTERISTICS

|                                      |   |  |    |    |      |       |
|--------------------------------------|---|--|----|----|------|-------|
| BV <sub>DSS</sub>                    | Drain–Source Breakdown Voltage            | V <sub>GS</sub> = 0 V, I <sub>D</sub> = 250 μA | 60 |    |      | V     |
| ΔBV <sub>DSS</sub> / ΔT <sub>J</sub> | Breakdown Voltage Temperature Coefficient | I <sub>D</sub> = –250 μA, Referenced to 25°C   |    | 62 |      | mV/°C |
| I <sub>DSS</sub>                     | Zero Gate Voltage Drain Current           | V <sub>DS</sub> = 48 V, V <sub>GS</sub> = 0 V  |    |    | 1    | μA    |
| I <sub>GSSF</sub>                    | Gate–Body Leakage, Forward                | V <sub>GS</sub> = 20 V, V <sub>DS</sub> = 0 V  |    |    | 100  | nA    |
| I <sub>GSSR</sub>                    | Gate–Body Leakage, Reverse                | V <sub>GS</sub> = –20V, V <sub>DS</sub> = 0 V  |    |    | –100 | nA    |

### ON CHARACTERISTICS (Note 2)

|  |  |   |   |     |   |       |
|--|--|---|---|-----|---|-------|
| V <sub>GS(th)</sub>                    | Gate Threshold Voltage                         | V <sub>DS</sub> = V <sub>GS</sub> , I <sub>D</sub> = 250 μA | 1 | 2.4 | 3 | V     |
| ΔV <sub>GS(th)</sub> / ΔT <sub>J</sub> | Gate Threshold Voltage Temperature Coefficient | I <sub>D</sub> = 250 μA, Referenced to 25°C                 |   | –6  |   | mV/°C |

# FDD5612

## ELECTRICAL CHARACTERISTICS ( $T_A = 25^\circ\text{C}$ unless otherwise noted) (continued)

| Symbol                             | Parameter                         | Test Conditions  | Min | Typ            | Max             | Unit             |
|------------------------------------|-----------------------------------|--|-----|----------------|-----------------|------------------|
| <b>ON CHARACTERISTICS</b> (Note 2) |                                   |  |     |                |                 |                  |
| $R_{DS(on)}$                       | Static Drain–Source On–Resistance | $V_{GS} = 10\text{ V}, I_D = 5.4\text{ A}$<br>$V_{GS} = 6\text{ V}, I_D = 5\text{ A}$<br>$V_{GS} = 10\text{ V}, I_D = 5.4\text{ A}, T_J = 125^\circ\text{C}$ |     | 36<br>42<br>64 | 55<br>64<br>103 | $\text{m}\Omega$ |
| $I_{D(on)}$                        | On–State Drain Current            | $V_{GS} = 10\text{ V}, V_{DS} = 5\text{ V}$  | 20  |                |                 | A                |
| $g_{FS}$                           | Forward Transconductance          | $V_{DS} = 5\text{ V}, I_D = 5.4\text{ A}$  |     | 15             |                 | S                |

## DYNAMIC CHARACTERISTICS

|           |                              |  |  |     |  |             |
|-----------|------------------------------|--|--|-----|--|-------------|
| $C_{iss}$ | Input Capacitance            | $V_{DS} = 30\text{ V}, V_{GS} = 0\text{ V},$<br>$f = 1.0\text{ MHz}$ |  | 660 |  | $\text{pF}$ |
| $C_{oss}$ | Output Capacitance           |  |  | 79  |  | $\text{pF}$ |
| $C_{rss}$ | Reverse Transfer Capacitance |  |  | 36  |  | $\text{pF}$ |

## SWITCHING CHARACTERISTICS (Note 2)

|              |                     |  |  |     |    |    |
|--------------|---------------------|--|--|-----|----|----|
| $t_{d(on)}$  | Turn–On Delay Time  | $V_{DD} = 30\text{ V}, I_D = 1\text{ A},$<br>$V_{GS} = 10\text{ V}, R_{GEN} = 6\ \Omega$ |  | 8   | 16 | ns |
| $t_r$        | Turn–On Rise Time   |  |  | 4   | 8  | ns |
| $t_{d(off)}$ | Turn–Off Delay Time |  |  | 24  | 38 | ns |
| $t_f$        | Turn–Off Fall Time  |  |  | 4   | 8  | ns |
| $Q_g$        | Total Gate Charge   | $V_{DS} = 30\text{ V}, I_D = 5.4\text{ A},$<br>$V_{GS} = 10\text{ V}$                    |  | 7.5 | 11 | nC |
| $Q_{gs}$     | Gate–Source Charge  |  |  | 2.5 |    | nC |
| $Q_{gd}$     | Gate–Drain Charge   |  |  | 3   |    | nC |

## DRAIN–SOURCE DIODE CHARACTERISTICS AND MAXIMUM RATINGS

|          |                                    |  |  |     |     |   |
|----------|------------------------------------|--|--|-----|-----|---|
| $I_S$    | Source Current (Body Diode)        | $T_C = 25^\circ\text{C}$                           |  |     | 18  | A |
| $V_{SD}$ | Drain–Source Diode Forward Voltage | $V_{GS} = 0\text{ V}, I_S = 2.7\text{ A}$ (Note 2) |  | 0.8 | 1.2 | V |

Product parametric performance is indicated in the Electrical Characteristics for the listed test conditions, unless otherwise noted. Product performance may not be indicated by the Electrical Characteristics if operated under different conditions.

### NOTES:

- $R_{\theta JA}$  is the sum of the junction–to–case and case–to–ambient thermal resistance where the case thermal reference is defined as the drain tab.  $R_{\theta JA}$  is the guaranteed design while  $R_{\theta JA}$  is determined by the user's design.  $R_{\theta JA}$  has been used to determine some of the maximum ratings.

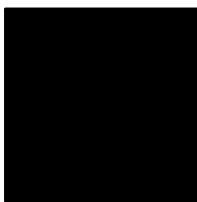

- a)  $R_{\theta JA} = 40^\circ\text{C/W}$  when mounted on a  $1\text{ in}^2$  pad of 2 oz copper



- b)  $R_{\theta JA} = 96^\circ\text{C/W}$  when mounted on a  $0.076\text{ in}^2$  pad of 2 oz copper

- Pulse Test: Pulse Width < 300  $\mu\text{s}$ , Duty Cycle < 2.0%

TYPICAL CHARACTERISTICS

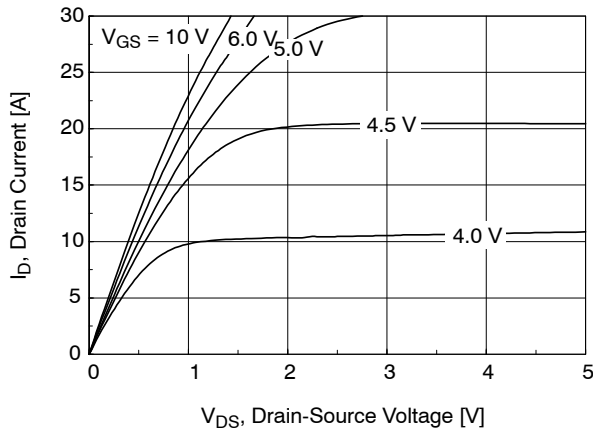

Figure 1. On-Region Characteristics

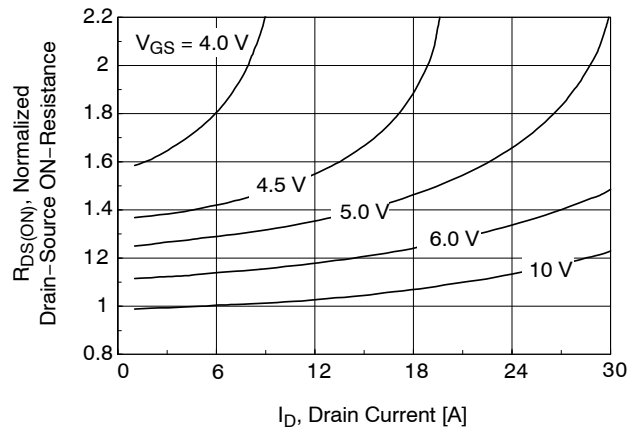

Figure 2. On-Resistance Variation with Drain Current and Gate Voltage

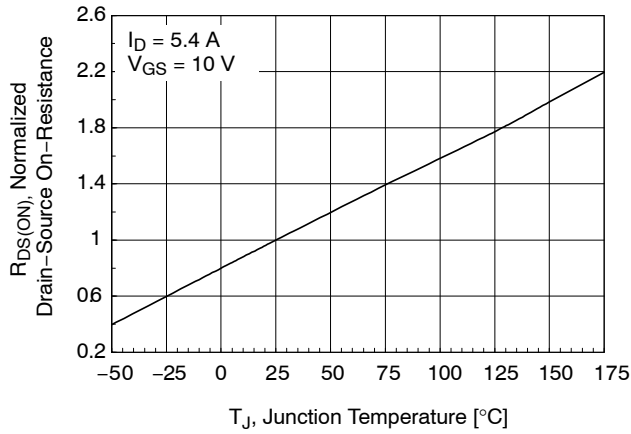

Figure 3. On-Resistance Variation with Temperature

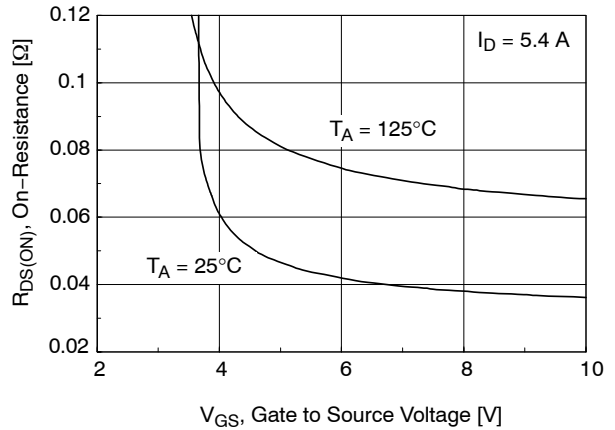

Figure 4. On-Resistance Variation with Gate-to-Source Voltage

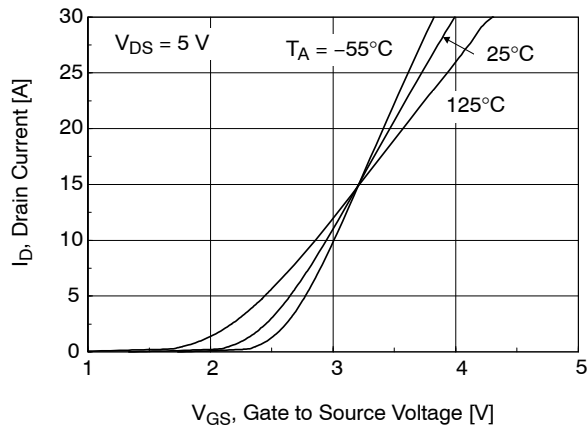

Figure 5. Transfer Characteristics

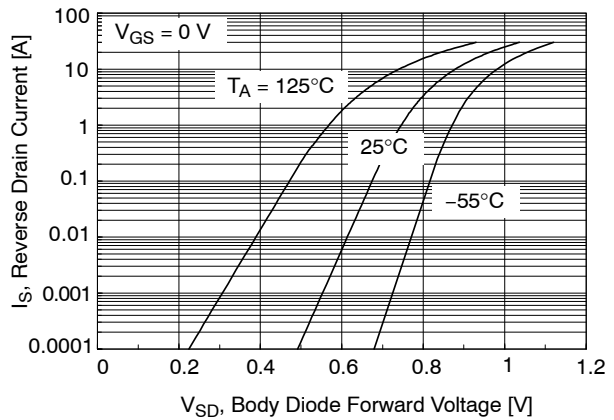

Figure 6. Body Diode Forward Voltage Variation with Source Current and Temperature

TYPICAL CHARACTERISTICS (continued)

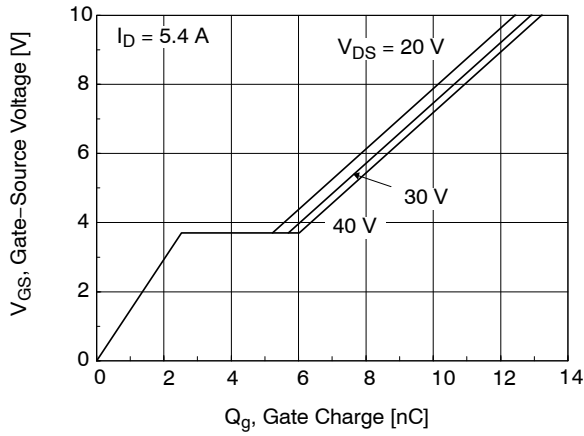

Figure 7. Gate Charge Characteristics

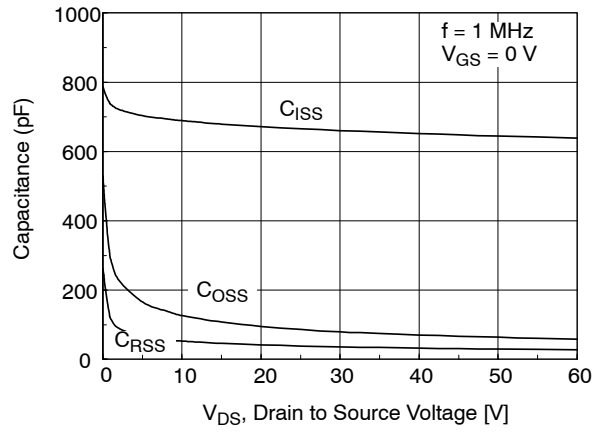

Figure 8. Capacitance Characteristics

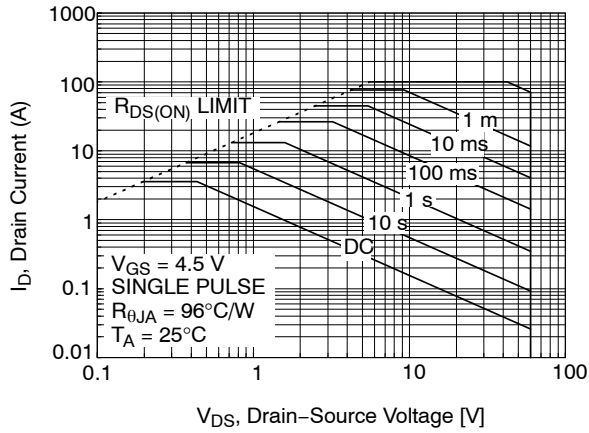

Figure 9. Maximum Safe Operating Area

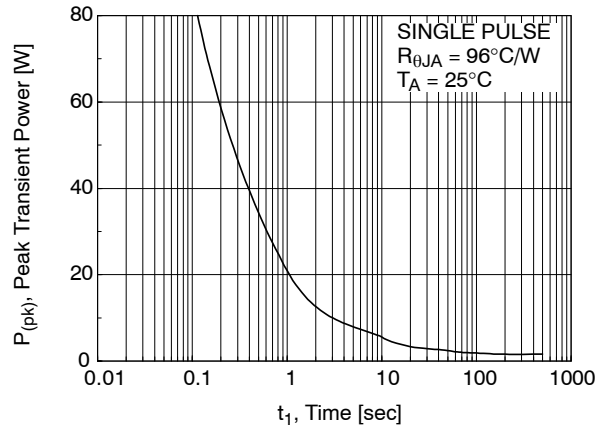

Figure 10. Single Pulse Maximum Power Dissipation

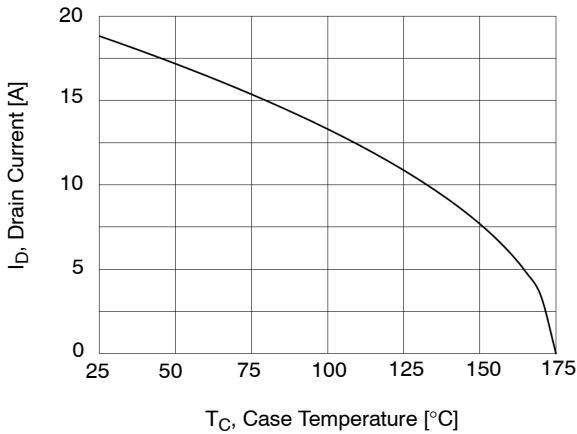
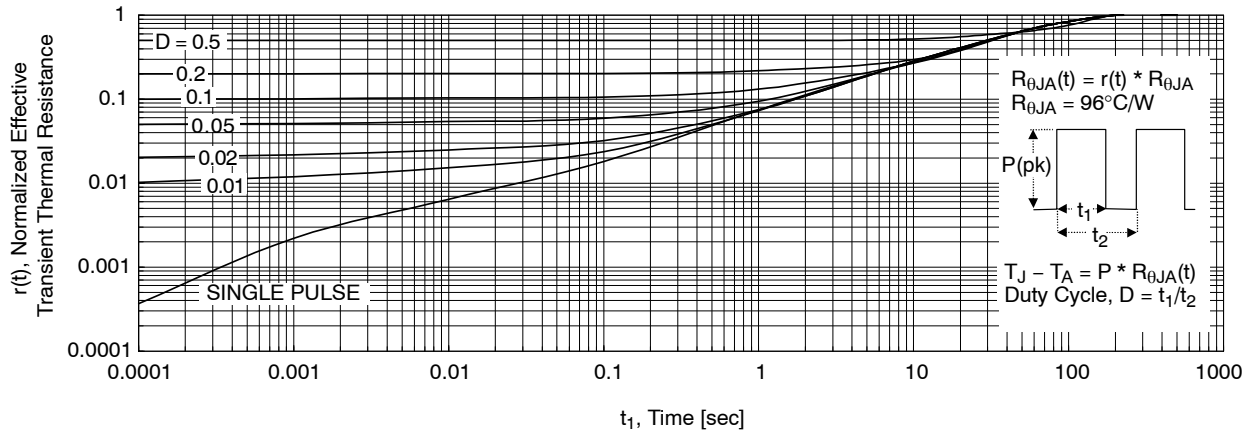

Figure 11. Maximum Drain Current vs. Case Temperature

# FDD5612

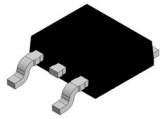

**Figure 12. Transient Thermal Response Curve**

**NOTES:**

3. Thermal characterization performed using the conditions described in Note 1b.
4. Transient thermal response will change depending on the circuit board design.

# MECHANICAL CASE OUTLINE PACKAGE DIMENSIONS



## DPAK3 (TO-252 3 LD) CASE 369AS ISSUE A

DATE 28 SEP 2022

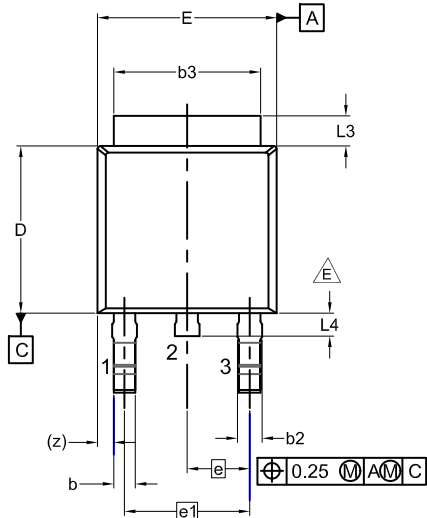

- NOTES: UNLESS OTHERWISE SPECIFIED  
 A) THIS PACKAGE CONFORMS TO JEDEC, TO-252, ISSUE C, VARIATION AA.  
 B) ALL DIMENSIONS ARE IN MILLIMETERS.  
 C) DIMENSIONING AND TOLERANCING PER ASME Y14.5M-2009.  
 D) SUPPLIER DEPENDENT MOLD LOCKING HOLES OR CHAMFERED CORNERS OR EDGE PROTRUSION.  
 E) FOR DIODE PRODUCTS, L4 IS 0.25 MM MAX.  
 F) DIMENSIONS ARE EXCLUSIVE OF BURRS, MOLD FLASH AND TIE BAR EXTRUSIONS.  
 G) LAND PATTERN RECOMMENDATION IS BASED ON IPC7351A STD TO228P991X239-3N.

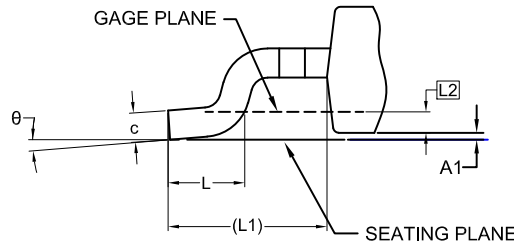

**DETAIL A**  
(ROTATED -90°)  
SCALE: 12X

| DIM | MILLIMETERS |      |       |
|-----|-------------|------|-------|
|     | MIN.        | NOM. | MAX.  |
| A   | 2.18        | 2.29 | 2.39  |
| A1  | 0.00        | -    | 0.127 |
| b   | 0.64        | 0.77 | 0.89  |
| b2  | 0.76        | 0.95 | 1.14  |
| b3  | 5.21        | 5.34 | 5.46  |
| c   | 0.45        | 0.53 | 0.61  |
| c2  | 0.45        | 0.52 | 0.58  |
| D   | 5.97        | 6.10 | 6.22  |
| D1  | 5.21        | -    | -     |
| E   | 6.35        | 6.54 | 6.73  |
| E1  | 4.32        | -    | -     |
| e   | 2.286 BSC   |      |       |
| e1  | 4.572 BSC   |      |       |
| H   | 9.40        | 9.91 | 10.41 |
| L   | 1.40        | 1.59 | 1.78  |
| L1  | 2.90 REF    |      |       |
| L2  | 0.51 BSC    |      |       |
| L3  | 0.89        | 1.08 | 1.27  |
| L4  | -           | -    | 1.02  |
| θ   | 0°          | --   | 10°   |

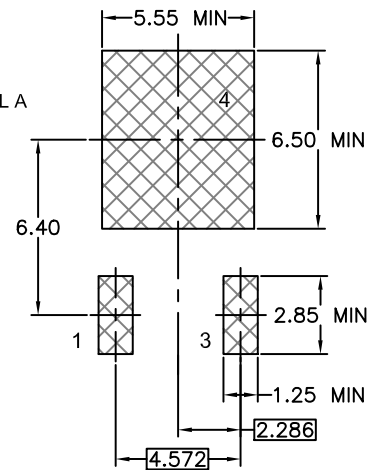
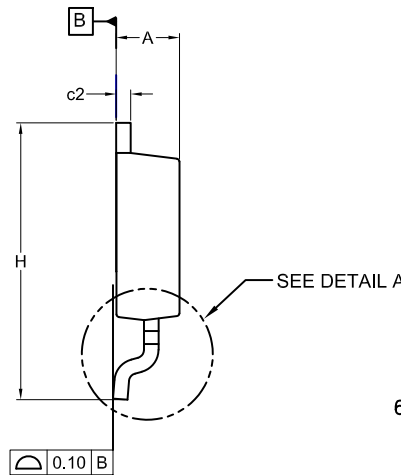
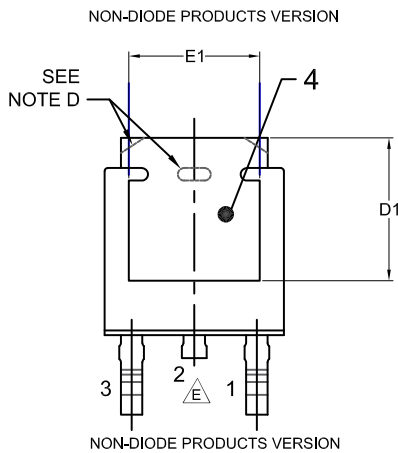

### GENERIC MARKING DIAGRAM\*



- XXXX = Specific Device Code
- A = Assembly Location
- Y = Year
- WW = Work Week
- ZZ = Assembly Lot Code

\*This information is generic. Please refer to device data sheet for actual part marking. Pb-free indicator, "G" or microdot "•", may or may not be present. Some products may not follow the Generic Marking.

### LAND PATTERN RECOMMENDATION

\*FOR ADDITIONAL INFORMATION ON OUR PB-FREE STRATEGY AND SOLDERING DETAILS, PLEASE DOWNLOAD THE ON SEMICONDUCTOR SOLDERING AND MOUNTING TECHNIQUES REFERENCE MANUAL, SOLDERRM/D.

|                         |                            |  |
|-------------------------|----------------------------|--|
| <b>DOCUMENT NUMBER:</b> | <b>98AON13810G</b>         | Electronic versions are uncontrolled except when accessed directly from the Document Repository. Printed versions are uncontrolled except when stamped "CONTROLLED COPY" in red. |
| <b>DESCRIPTION:</b>     | <b>DPAK3 (TO-252 3 LD)</b> | <b>PAGE 1 OF 1</b>   |

onsemi and ONSEMI are trademarks of Semiconductor Components Industries, LLC dba onsemi or its subsidiaries in the United States and/or other countries. onsemi reserves the right to make changes without further notice to any products herein. onsemi makes no warranty, representation or guarantee regarding the suitability of its products for any particular purpose, nor does onsemi assume any liability arising out of the application or use of any product or circuit, and specifically disclaims any and all liability, including without limitation special, consequential or incidental damages. onsemi does not convey any license under its patent rights nor the rights of others.

**onsemi**, **Onsemi**, and other names, marks, and brands are registered and/or common law trademarks of Semiconductor Components Industries, LLC dba "**onsemi**" or its affiliates and/or subsidiaries in the United States and/or other countries. **onsemi** owns the rights to a number of patents, trademarks, copyrights, trade secrets, and other intellectual property. A listing of **onsemi**'s product/patent coverage may be accessed at [www.onsemi.com/site/pdf/Patent-Marking.pdf](http://www.onsemi.com/site/pdf/Patent-Marking.pdf). **onsemi** reserves the right to make changes at any time to any products or information herein, without notice. The information herein is provided "as-is" and **onsemi** makes no warranty, representation or guarantee regarding the accuracy of the information, product features, availability, functionality, or suitability of its products for any particular purpose, nor does **onsemi** assume any liability arising out of the application or use of any product or circuit, and specifically disclaims any and all liability, including without limitation special, consequential or incidental damages. Buyer is responsible for its products and applications using **onsemi** products, including compliance with all laws, regulations and safety requirements or standards, regardless of any support or applications information provided by **onsemi**. "Typical" parameters which may be provided in **onsemi** data sheets and/or specifications can and do vary in different applications and actual performance may vary over time. All operating parameters, including "Typicals" must be validated for each customer application by customer's technical experts. **onsemi** does not convey any license under any of its intellectual property rights nor the rights of others. **onsemi** products are not designed, intended, or authorized for use as a critical component in life support systems or any FDA Class 3 medical devices or medical devices with a same or similar classification in a foreign jurisdiction or any devices intended for implantation in the human body. Should Buyer purchase or use **onsemi** products for any such unintended or unauthorized application, Buyer shall indemnify and hold **onsemi** and its officers, employees, subsidiaries, affiliates, and distributors harmless against all claims, costs, damages, and expenses, and reasonable attorney fees arising out of, directly or indirectly, any claim of personal injury or death associated with such unintended or unauthorized use, even if such claim alleges that **onsemi** was negligent regarding the design or manufacture of the part. **onsemi** is an Equal Opportunity/Affirmative Action Employer. This literature is subject to all applicable copyright laws and is not for resale in any manner.

## PUBLICATION ORDERING INFORMATION

### LITERATURE FULFILLMENT:

Email Requests to: [orderlit@onsemi.com](mailto:orderlit@onsemi.com)

**onsemi Website:** [www.onsemi.com](http://www.onsemi.com)

### TECHNICAL SUPPORT

**North American Technical Support:**

Voice Mail: 1 800-282-9855 Toll Free USA/Canada

Phone: 011 421 33 790 2910

**Europe, Middle East and Africa Technical Support:**

Phone: 00421 33 790 2910

For additional information, please contact your local Sales Representative