



Is Now Part of



ON Semiconductor®

To learn more about ON Semiconductor, please visit our website at
www.onsemi.com

Please note: As part of the Fairchild Semiconductor integration, some of the Fairchild orderable part numbers will need to change in order to meet ON Semiconductor's system requirements. Since the ON Semiconductor product management systems do not have the ability to manage part nomenclature that utilizes an underscore (_), the underscore (_) in the Fairchild part numbers will be changed to a dash (-). This document may contain device numbers with an underscore (_). Please check the ON Semiconductor website to verify the updated device numbers. The most current and up-to-date ordering information can be found at www.onsemi.com. Please email any questions regarding the system integration to Fairchild_questions@onsemi.com.

ON Semiconductor and the ON Semiconductor logo are trademarks of Semiconductor Components Industries, LLC dba ON Semiconductor or its subsidiaries in the United States and/or other countries. ON Semiconductor owns the rights to a number of patents, trademarks, copyrights, trade secrets, and other intellectual property. A listing of ON Semiconductor's product/patent coverage may be accessed at www.onsemi.com/site/pdf/Patent-Marking.pdf. ON Semiconductor reserves the right to make changes without further notice to any products herein. ON Semiconductor makes no warranty, representation or guarantee regarding the suitability of its products for any particular purpose, nor does ON Semiconductor assume any liability arising out of the application or use of any product or circuit, and specifically disclaims any and all liability, including without limitation special, consequential or incidental damages. Buyer is responsible for its products and applications using ON Semiconductor products, including compliance with all laws, regulations and safety requirements or standards, regardless of any support or applications information provided by ON Semiconductor. "Typical" parameters which may be provided in ON Semiconductor data sheets and/or specifications can and do vary in different applications and actual performance may vary over time. All operating parameters, including "Typicals" must be validated for each customer application by customer's technical experts. ON Semiconductor does not convey any license under its patent rights nor the rights of others. ON Semiconductor products are not designed, intended, or authorized for use as a critical component in life support systems or any FDA Class 3 medical devices or medical devices with a same or similar classification in a foreign jurisdiction or any devices intended for implantation in the human body. Should Buyer purchase or use ON Semiconductor products for any such unintended or unauthorized application, Buyer shall indemnify and hold ON Semiconductor and its officers, employees, subsidiaries, affiliates, and distributors harmless against all claims, costs, damages, and expenses, and reasonable attorney fees arising out of, directly or indirectly, any claim of personal injury or death associated with such unintended or unauthorized use, even if such claim alleges that ON Semiconductor was negligent regarding the design or manufacture of the part. ON Semiconductor is an Equal Opportunity/Affirmative Action Employer. This literature is subject to all applicable copyright laws and is not for resale in any manner.

FDC8602

Dual N-Channel Shielded Gate PowerTrench® MOSFET 100 V, 1.2 A, 350 mΩ

Features

- Shielded Gate MOSFET Technology
- Max $r_{DS(on)}$ = 350 mΩ at $V_{GS} = 10$ V, $I_D = 1.2$ A
- Max $r_{DS(on)}$ = 575 mΩ at $V_{GS} = 6$ V, $I_D = 0.9$ A
- High performance trench technology for extremely low $r_{DS(on)}$
- High power and current handling capability in a widely used surface mount package
- Fast switching speed
- 100% UIL Tested
- RoHS Compliant



General Description

This N-Channel MOSFET is produced using Fairchild Semiconductor's advanced PowerTrench® process that incorporates Shielded Gate technology. This process has been optimized for $r_{DS(on)}$, switching performance and ruggedness.

Applications

- Load Switch
- Synchronous Rectifier

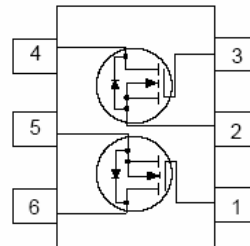
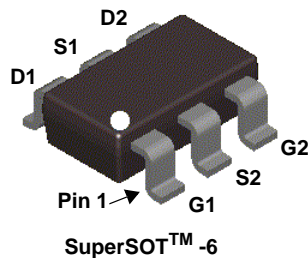

MOSFET Maximum Ratings $T_A = 25$ °C unless otherwise noted

Symbol	Parameter	Ratings	Units
V_{DS}	Drain to Source Voltage	100	V
V_{GS}	Gate to Source Voltage	±20	V
I_D	Drain Current -Continuous (Note 1a)	1.2	A
	-Pulsed	5	A
E_{AS}	Single Pulse Avalanche Energy (Note 3)	1.5	mJ
P_D	Power Dissipation (Note 1a)	0.96	W
	Power Dissipation (Note 1b)	0.69	
T_J, T_{STG}	Operating and Storage Junction Temperature Range	-55 to +150	°C

Thermal Characteristics

$R_{\theta JC}$	Thermal Resistance, Junction to Case	60	°C/W
$R_{\theta JA}$	Thermal Resistance, Junction to Ambient (Note 1a)	130	

Package Marking and Ordering Information

Device Marking	Device	Package	Reel Size	Tape Width	Quantity
.862	FDC8602	SSOT-6	7"	8 mm	3000 units

Electrical Characteristics $T_J = 25\text{ }^\circ\text{C}$ unless otherwise noted

Symbol	Parameter	Test Conditions	Min	Typ	Max	Units
--------	-----------	-----------------	-----	-----	-----	-------

Off Characteristics

BV_{DSS}	Drain to Source Breakdown Voltage	$I_D = 250\text{ }\mu\text{A}$, $V_{GS} = 0\text{ V}$	100			V
$\frac{\Delta BV_{DSS}}{\Delta T_J}$	Breakdown Voltage Temperature Coefficient	$I_D = 250\text{ }\mu\text{A}$, referenced to $25\text{ }^\circ\text{C}$		73		mV/ $^\circ\text{C}$
I_{DSS}	Zero Gate Voltage Drain Current	$V_{DS} = 80\text{ V}$, $V_{GS} = 0\text{ V}$			1	μA
I_{GSS}	Gate to Source Leakage Current	$V_{GS} = \pm 20\text{ V}$, $V_{DS} = 0\text{ V}$			± 100	nA

On Characteristics

$V_{GS(th)}$	Gate to Source Threshold Voltage	$V_{GS} = V_{DS}$, $I_D = 250\text{ }\mu\text{A}$	2	3.2	4	V
$\frac{\Delta V_{GS(th)}}{\Delta T_J}$	Gate to Source Threshold Voltage Temperature Coefficient	$I_D = 250\text{ }\mu\text{A}$, referenced to $25\text{ }^\circ\text{C}$		-8		mV/ $^\circ\text{C}$
$r_{DS(on)}$	Static Drain to Source On Resistance	$V_{GS} = 10\text{ V}$, $I_D = 1.2\text{ A}$		285	350	m Ω
		$V_{GS} = 6\text{ V}$, $I_D = 0.9\text{ A}$		409	575	
		$V_{GS} = 10\text{ V}$, $I_D = 1.2\text{ A}$, $T_J = 125\text{ }^\circ\text{C}$		489	600	
g_{FS}	Forward Transconductance	$V_{DS} = 10\text{ V}$, $I_D = 1.2\text{ A}$		1.3		S

Dynamic Characteristics

C_{iss}	Input Capacitance	$V_{DS} = 50\text{ V}$, $V_{GS} = 0\text{ V}$, $f = 1\text{ MHz}$		53	70	pF
C_{oss}	Output Capacitance			17	25	pF
C_{rss}	Reverse Transfer Capacitance			0.8	5	pF
R_g	Gate Resistance			1.6		Ω

Switching Characteristics

$t_{d(on)}$	Turn-On Delay Time	$V_{DD} = 50\text{ V}$, $I_D = 1.2\text{ A}$, $V_{GS} = 10\text{ V}$, $R_{GEN} = 6\text{ }\Omega$		3.5	10	ns	
t_r	Rise Time			1.7	10	ns	
$t_{d(off)}$	Turn-Off Delay Time			5.4	11	ns	
t_f	Fall Time			2.3	10	ns	
$Q_{g(TOT)}$	Total Gate Charge		$V_{GS} = 0\text{ V to }10\text{ V}$		1.2	2	nC
$Q_{g(TOT)}$	Total Gate Charge	$V_{GS} = 0\text{ V to }5\text{ V}$	$V_{DD} = 50\text{ V}$, $I_D = 1.2\text{ A}$		0.6	1	nC
Q_{gs}	Gate to Source Charge				0.4		nC
Q_{gd}	Gate to Drain "Miller" Charge				0.4		nC

Drain-Source Diode Characteristics

V_{SD}	Source-Drain Diode Forward Voltage	$V_{GS} = 0\text{ V}$, $I_S = 1.2\text{ A}$ (Note 2)		0.86	1.3	V
t_{rr}	Reverse Recovery Time	$I_F = 1.2\text{ A}$, $di/dt = 100\text{ A}/\mu\text{s}$		27	43	ns
Q_{rr}	Reverse Recovery Charge			12	21	nC

NOTES:

- $R_{\theta JA}$ is the sum of the junction-to-case and case-to-ambient thermal resistance where the case thermal reference is defined as the solder mounting surface of the drain pins. $R_{\theta JC}$ is guaranteed by design while $R_{\theta CA}$ is determined by the user's board design.



a) $130\text{ }^\circ\text{C/W}$ when mounted on a 1 in^2 pad of 2oz copper



b) $180\text{ }^\circ\text{C/W}$ when mounted on a minimum pad of 2oz copper

2. Pulse Test: Pulse Width < $300\text{ }\mu\text{s}$, Duty cycle < 2.0%.

3. Starting $T_J = 25\text{ }^\circ\text{C}$; N-ch: $L = 3\text{ mH}$, $I_{AS} = 1\text{ A}$, $V_{DD} = 100\text{ V}$, $V_{GS} = 10\text{ V}$.

Typical Characteristics $T_J = 25\text{ }^\circ\text{C}$ unless otherwise noted

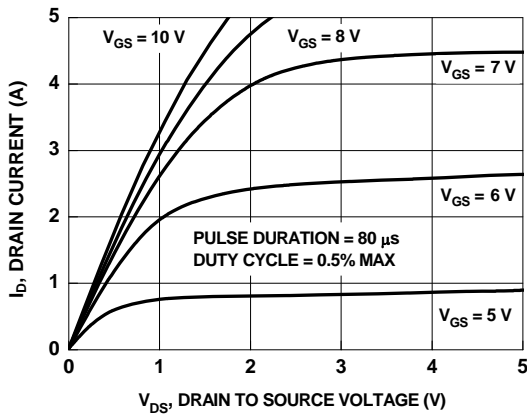

Figure 1. On Region Characteristics

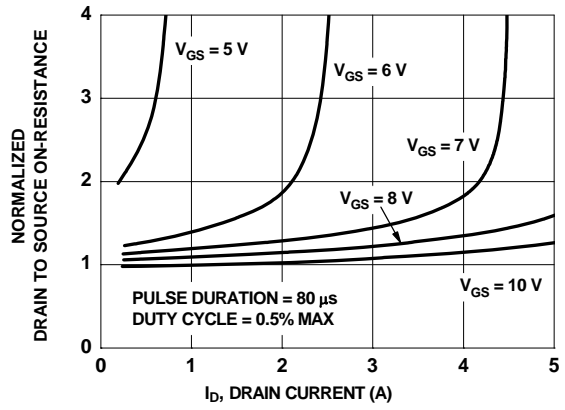

Figure 2. Normalized On-Resistance vs Drain Current and Gate Voltage

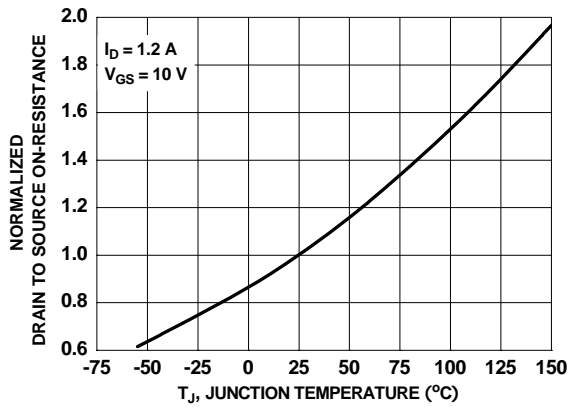

Figure 3. Normalized On Resistance vs Junction Temperature

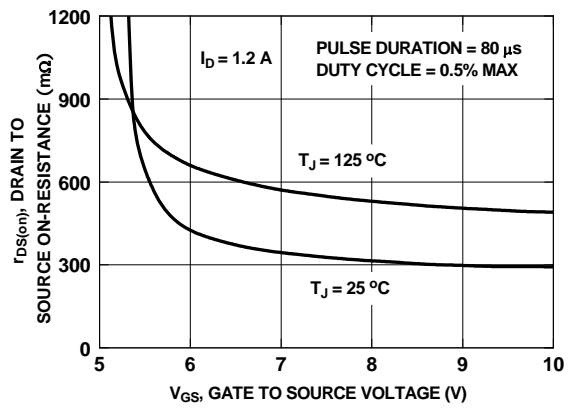

Figure 4. On-Resistance vs Gate to Source Voltage

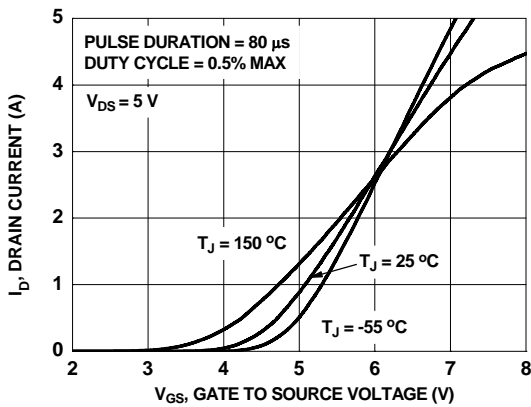

Figure 5. Transfer Characteristics

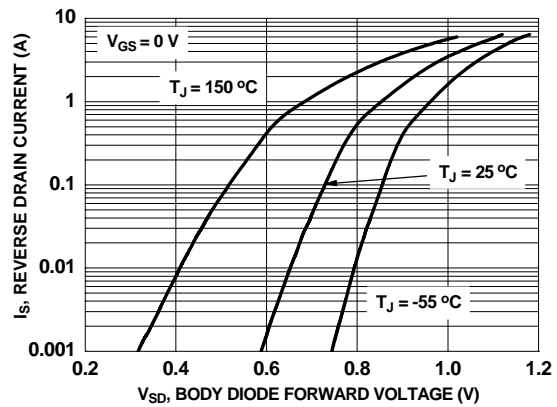

Figure 6. Source to Drain Diode Forward Voltage vs Source Current

Typical Characteristics $T_J = 25\text{ }^\circ\text{C}$ unless otherwise noted

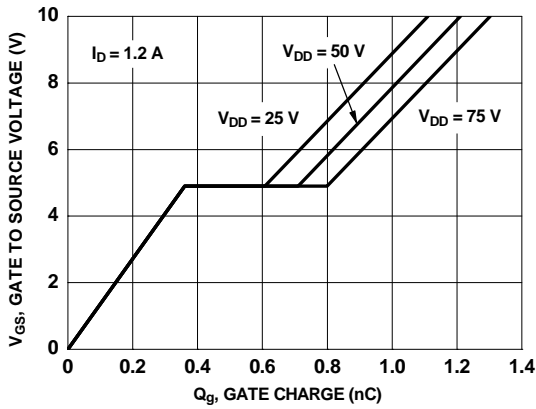

Figure 7. Gate Charge Characteristics

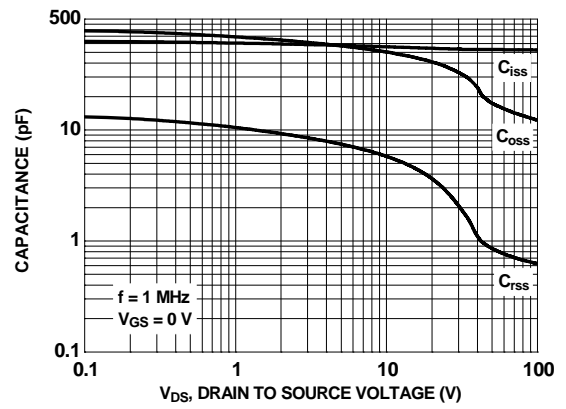

Figure 8. Capacitance vs Drain to Source Voltage

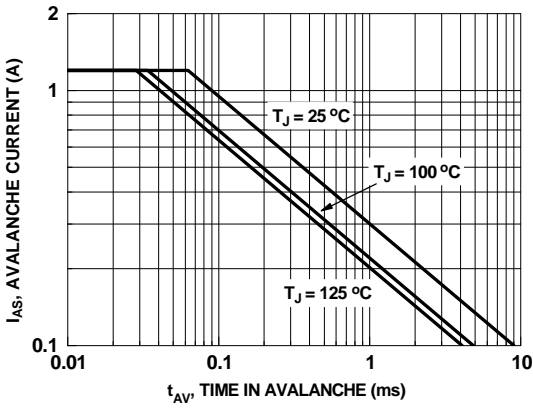

Figure 9. Unclamped Inductive Switching Capability

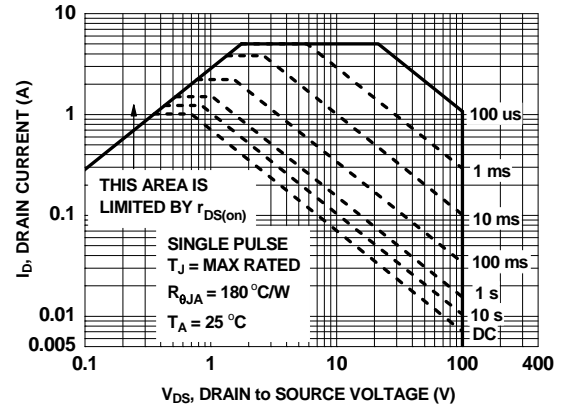

Figure 10. Forward Bias Safe Operating Area

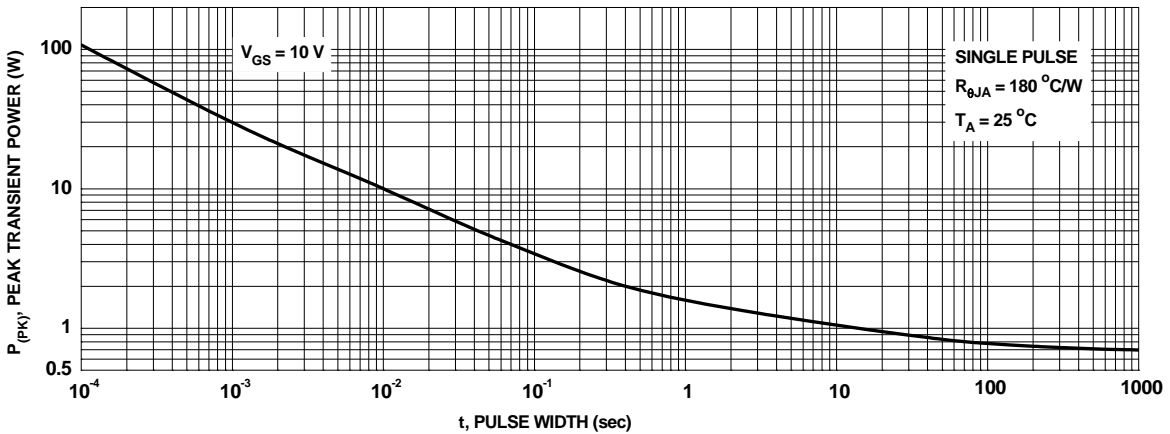

Figure 11. Single Pulse Maximum Power Dissipation

Typical Characteristics $T_J = 25\text{ }^\circ\text{C}$ unless otherwise noted

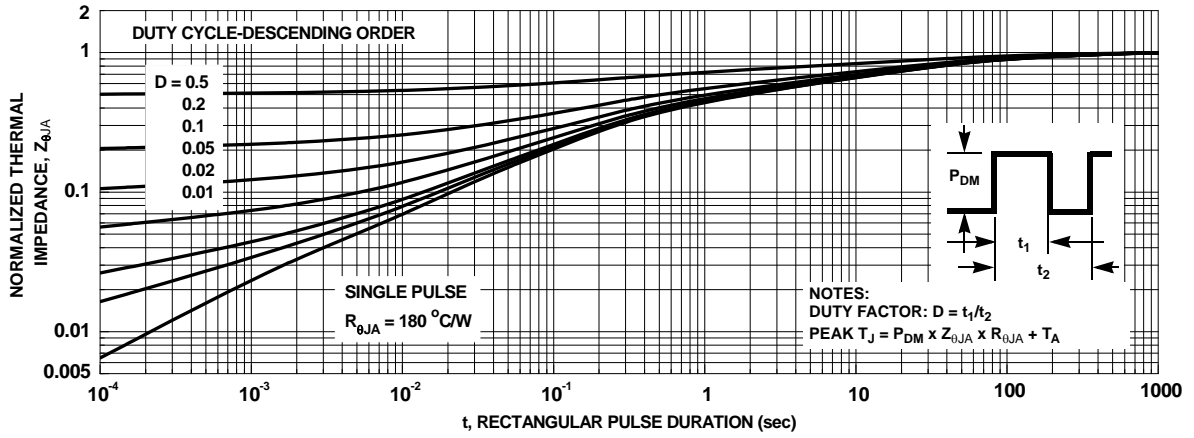
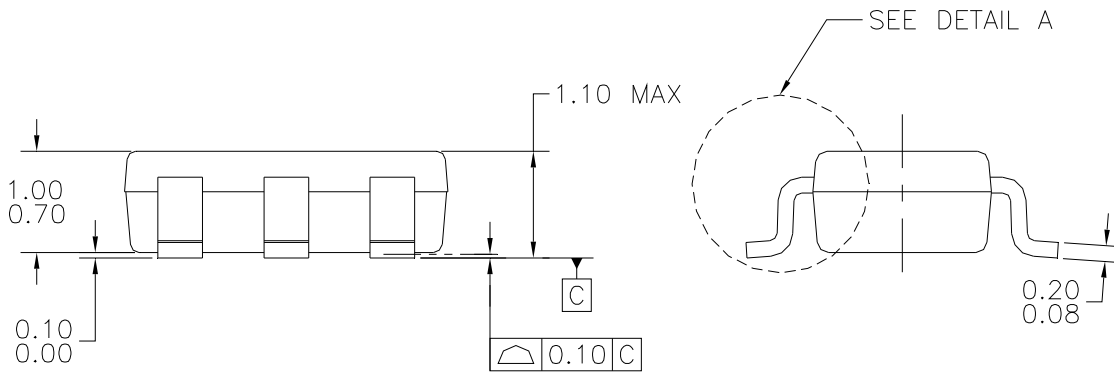
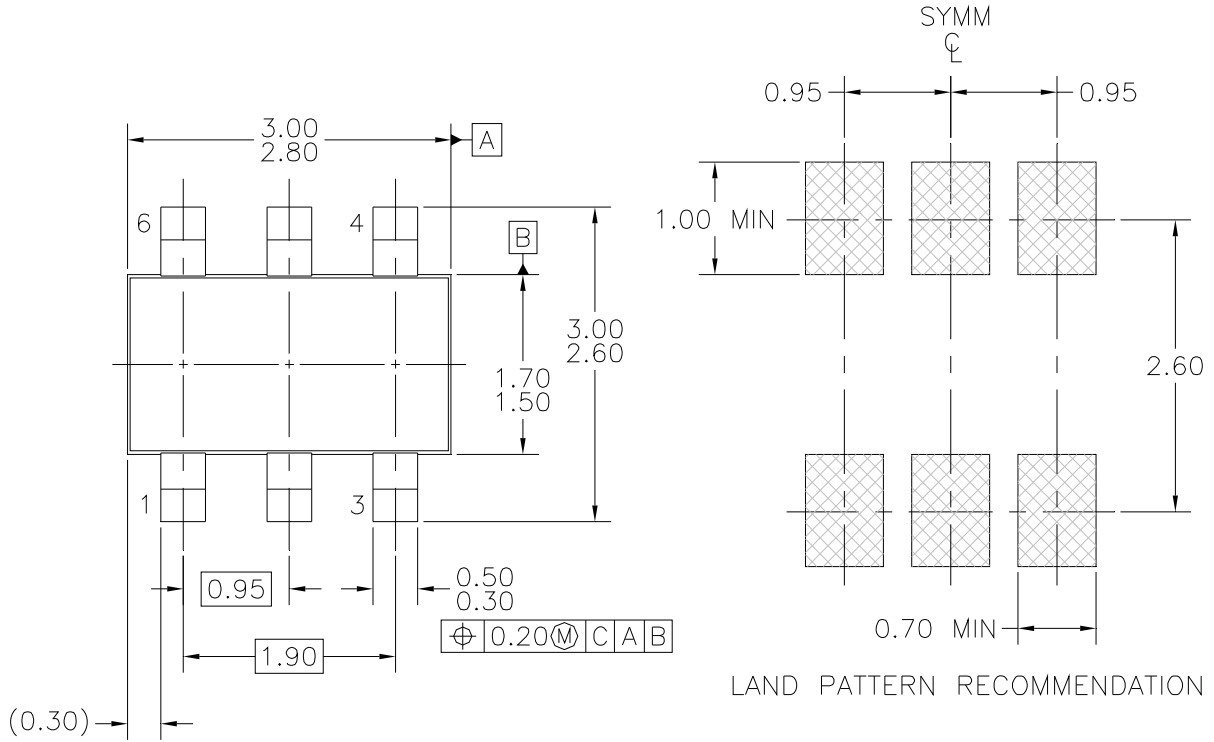

Figure 12. Junction-to-Ambient Transient Thermal Response Curve

Dimensional Outline and Pad Layout



NOTES: UNLESS OTHERWISE SPECIFIED

- A) THIS PACKAGE CONFORMS TO JEDEC MO-193. VAR. AA, ISSUE C, DATED JANUARY 2000.
- B) ALL DIMENSIONS ARE IN MILLIMETERS.

DETAIL A
SCALE: 50X

MA06AREVD



TRADEMARKS

The following includes registered and unregistered trademarks and service marks, owned by Fairchild Semiconductor and/or its global subsidiaries, and is not intended to be an exhaustive list of all such trademarks.

- | | | | |
|---|---|---------------------------------------|------------------|
| 2Cool™ | FPST™ | PowerTrench® | Sync-Lock™ |
| AccuPower™ | F-PFST™ | PowerXST™ | SYSTEM GENERAL®* |
| AX-CAP®* | FRFET® | Programmable Active Droop™ | TinyBoost™ |
| BitSiC™ | Global Power Resource SM | QFET® | TinyBuck™ |
| Build it Now™ | Green Bridge™ | QS™ | TinyCalc™ |
| CorePLUS™ | Green FPS™ | Quiet Series™ | TinyLogic® |
| CorePOWER™ | Green FPS™ e-Series™ | RapidConfigure™ | TINYOPTO™ |
| CROSSVOLT™ | Gmax™ | Saving our world, 1mW/W/kW at a time™ | TinyPower™ |
| CTL™ | GTO™ | SignalWise™ | TinyPWM™ |
| Current Transfer Logic™ | IntelliMAX™ | SmartMax™ | TinyWire™ |
| DEUXPEED® | ISOPLANAR™ | SMART START™ | TranSiC® |
| Dual Cool™ | Marking Small Speakers Sound Louder and Better™ | Solutions for Your Success™ | TriFault Detect™ |
| EcoSPARK® | MegaBuck™ | SPM® | TRUECURRENT®* |
| EfficientMax™ | MICROCOUPLER™ | STEALTH™ | µSerDes™ |
| ESBC™ | MicroFET™ | SuperFET® | UHC® |
|  | MicroPak™ | SuperSOT™-3 | Ultra FRFET™ |
| Fairchild® | MicroPak2™ | SuperSOT™-6 | UniFET™ |
| Fairchild Semiconductor® | MillerDrive™ | SuperSOT™-8 | VCX™ |
| FACT Quiet Series™ | MotionMax™ | SupreMOS® | VisualMax™ |
| FACT® | mWSaver™ | SyncFET™ | VoltagePlus™ |
| FAST® | OptoHiT™ | | XS™ |
| FastvCore™ | OPTOLOGIC® | | |
| FETBench™ | OPTOPLANAR® | | |

*Trademarks of System General Corporation, used under license by Fairchild Semiconductor.

DISCLAIMER

FAIRCHILD SEMICONDUCTOR RESERVES THE RIGHT TO MAKE CHANGES WITHOUT FURTHER NOTICE TO ANY PRODUCTS HEREIN TO IMPROVE RELIABILITY, FUNCTION, OR DESIGN. FAIRCHILD DOES NOT ASSUME ANY LIABILITY ARISING OUT OF THE APPLICATION OR USE OF ANY PRODUCT OR CIRCUIT DESCRIBED HEREIN; NEITHER DOES IT CONVEY ANY LICENSE UNDER ITS PATENT RIGHTS, NOR THE RIGHTS OF OTHERS. THESE SPECIFICATIONS DO NOT EXPAND THE TERMS OF FAIRCHILD'S WORLDWIDE TERMS AND CONDITIONS, SPECIFICALLY THE WARRANTY THEREIN, WHICH COVERS THESE PRODUCTS.

LIFE SUPPORT POLICY

FAIRCHILD'S PRODUCTS ARE NOT AUTHORIZED FOR USE AS CRITICAL COMPONENTS IN LIFE SUPPORT DEVICES OR SYSTEMS WITHOUT THE EXPRESS WRITTEN APPROVAL OF FAIRCHILD SEMICONDUCTOR CORPORATION.

As used here in:

- Life support devices or systems are devices or systems which, (a) are intended for surgical implant into the body or (b) support or sustain life, and (c) whose failure to perform when properly used in accordance with instructions for use provided in the labeling, can be reasonably expected to result in a significant injury of the user.
- A critical component in any component of a life support, device, or system whose failure to perform can be reasonably expected to cause the failure of the life support device or system, or to affect its safety or effectiveness.

ANTI-COUNTERFEITING POLICY

Fairchild Semiconductor Corporation's Anti-Counterfeiting Policy. Fairchild's Anti-Counterfeiting Policy is also stated on our external website, www.Fairchildsemi.com, under Sales Support. Counterfeiting of semiconductor parts is a growing problem in the industry. All manufactures of semiconductor products are experiencing counterfeiting of their parts. Customers who inadvertently purchase counterfeit parts experience many problems such as loss of brand reputation, substandard performance, failed application, and increased cost of production and manufacturing delays. Fairchild is taking strong measures to protect ourselves and our customers from the proliferation of counterfeit parts. Fairchild strongly encourages customers to purchase Fairchild parts either directly from Fairchild or from Authorized Fairchild Distributors who are listed by country on our web page cited above. Products customers buy either from Fairchild directly or from Authorized Fairchild Distributors are genuine parts, have full traceability, meet Fairchild's quality standards for handling and storage and provide access to Fairchild's full range of up-to-date technical and product information. Fairchild and our Authorized Distributors will stand behind all warranties and will appropriately address and warranty issues that may arise. Fairchild will not provide any warranty coverage or other assistance for parts bought from Unauthorized Sources. Fairchild is committed to combat this global problem and encourage our customers to do their part in stopping this practice by buying direct or from authorized distributors.

PRODUCT STATUS DEFINITIONS

Definition of Terms

Datasheet Identification	Product Status	Definition
Advance Information	Formative / In Design	Datasheet contains the design specifications for product development. Specifications may change in any manner without notice.
Preliminary	First Production	Datasheet contains preliminary data; supplementary data will be published at a later date. Fairchild Semiconductor reserves the right to make changes at any time without notice to improve design.
No Identification Needed	Full Production	Datasheet contains final specifications. Fairchild Semiconductor reserves the right to make changes at any time without notice to improve the design.
Obsolete	Not In Production	Datasheet contains specifications on a product that is discontinued by Fairchild Semiconductor. The datasheet is for reference information only.

ON Semiconductor and  are trademarks of Semiconductor Components Industries, LLC dba ON Semiconductor or its subsidiaries in the United States and/or other countries. ON Semiconductor owns the rights to a number of patents, trademarks, copyrights, trade secrets, and other intellectual property. A listing of ON Semiconductor's product/patent coverage may be accessed at www.onsemi.com/site/pdf/Patent-Marking.pdf. ON Semiconductor reserves the right to make changes without further notice to any products herein. ON Semiconductor makes no warranty, representation or guarantee regarding the suitability of its products for any particular purpose, nor does ON Semiconductor assume any liability arising out of the application or use of any product or circuit, and specifically disclaims any and all liability, including without limitation special, consequential or incidental damages. Buyer is responsible for its products and applications using ON Semiconductor products, including compliance with all laws, regulations and safety requirements or standards, regardless of any support or applications information provided by ON Semiconductor. "Typical" parameters which may be provided in ON Semiconductor data sheets and/or specifications can and do vary in different applications and actual performance may vary over time. All operating parameters, including "Typicals" must be validated for each customer application by customer's technical experts. ON Semiconductor does not convey any license under its patent rights nor the rights of others. ON Semiconductor products are not designed, intended, or authorized for use as a critical component in life support systems or any FDA Class 3 medical devices or medical devices with a same or similar classification in a foreign jurisdiction or any devices intended for implantation in the human body. Should Buyer purchase or use ON Semiconductor products for any such unintended or unauthorized application, Buyer shall indemnify and hold ON Semiconductor and its officers, employees, subsidiaries, affiliates, and distributors harmless against all claims, costs, damages, and expenses, and reasonable attorney fees arising out of, directly or indirectly, any claim of personal injury or death associated with such unintended or unauthorized use, even if such claim alleges that ON Semiconductor was negligent regarding the design or manufacture of the part. ON Semiconductor is an Equal Opportunity/Affirmative Action Employer. This literature is subject to all applicable copyright laws and is not for resale in any manner.

PUBLICATION ORDERING INFORMATION

LITERATURE FULFILLMENT:

Literature Distribution Center for ON Semiconductor
19521 E. 32nd Pkwy, Aurora, Colorado 80011 USA
Phone: 303-675-2175 or 800-344-3860 Toll Free USA/Canada
Fax: 303-675-2176 or 800-344-3867 Toll Free USA/Canada
Email: orderlit@onsemi.com

N. American Technical Support: 800-282-9855 Toll Free
USA/Canada
Europe, Middle East and Africa Technical Support:
Phone: 421 33 790 2910
Japan Customer Focus Center
Phone: 81-3-5817-1050

ON Semiconductor Website: www.onsemi.com
Order Literature: <http://www.onsemi.com/orderlit>
For additional information, please contact your local
Sales Representative