

# MOSFET – N-Channel, SUPERFET® II, FRFET®

650 V, 76 A, 41 mΩ

## FCH041N65F

### Description

SUPERFET II MOSFET is ON Semiconductor's brand-new high voltage super-junction (SJ) MOSFET family that is utilizing charge balance technology for outstanding low on-resistance and lower gate charge performance. This technology is tailored to minimize conduction loss, provide superior switching performance, dv/dt rate and higher avalanche energy. Consequently, SUPERFET II MOSFET is very suitable for the switching power applications such as PFC, server/telecom power, FPD TV power, ATX power and industrial power applications. SUPERFET II FRFET MOSFET's optimized body diode reverse recovery performance can remove additional component and improve system reliability.

### Features

- 700 V @  $T_J = 150^\circ\text{C}$
- Typ.  $R_{DS(on)} = 36\text{ m}\Omega$
- Ultra Low Gate Charge (Typ.  $Q_g = 226\text{ nC}$ )
- Low Effective Output Capacitance (Typ.  $C_{oss(eff.)} = 1278\text{ pF}$ )
- 100% Avalanche Tested
- This Device is Pb-Free and is RoHS Compliant

### Applications

- LCD, LED, PDP TV
- Solar Inverter
- Telecom, Server Power Supplies
- AC-DC Power Supply



ON Semiconductor®

[www.onsemi.com](http://www.onsemi.com)

$V_{DS}$	$R_{DS(on)}\text{ MAX}$	$I_D\text{ MAX}$
650 V	41 mΩ @ 10 V	76 A

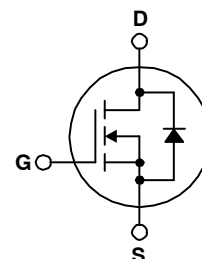

N-CHANNEL MOSFET

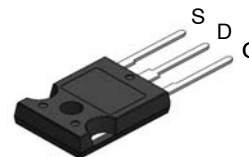

TO-247-3LD  
CASE 340CH

### MARKING DIAGRAM

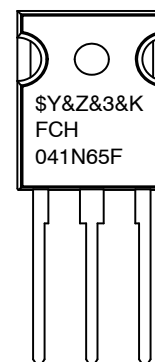

\$Y	= ON Semiconductor Logo
&Z	= Assembly Plant Code
&3	= Numeric Date Code
&K	= Lot Code
FCH041N65F	= Specific Device Code

### ORDERING INFORMATION

See detailed ordering and shipping information on page 2 of this data sheet.

# FCH041N65F

## ABSOLUTE MAXIMUM RATINGS (T<sub>C</sub> = 25°C unless otherwise noted)

Symbol	Parameter	FCH041N65F-F155	Unit
V <sub>DSS</sub>	Drain to Source Voltage	650	V
V <sub>GSS</sub>	Gate to Source Voltage	-DC	±20
		-AC (f > 1 Hz)	±30
I <sub>D</sub>	Drain Current	-Continuous (T <sub>C</sub> = 25°C)	76
		-Continuous (T <sub>C</sub> = 100°C)	48.1
I <sub>DM</sub>	Drain Current	-Pulsed (Note 1)	228
E <sub>AS</sub>	Single Pulsed Avalanche Energy (Note 2)	2025	mJ
I <sub>AR</sub>	Avalanche Current (Note 1)	15	A
E <sub>AR</sub>	Repetitive Avalanche Energy (Note 1)	5.95	mJ
dv/dt	MOSFET dv/dt	100	V/ns
	Peak Diode Recovery dv/dt (Note 3)	50	
P <sub>D</sub>	Power Dissipation	(T <sub>C</sub> = 25°C)	595
		-Derate Above 25°C	4.76
T <sub>J</sub> , T <sub>STG</sub>	Operating and Storage Temperature Range	-55 to + 150	°C
T <sub>L</sub>	Maximum Lead Temperature for Soldering, 1/8 from Case for 5 Seconds	300	°C

Stresses exceeding those listed in the Maximum Ratings table may damage the device. If any of these limits are exceeded, device functionality should not be assumed, damage may occur and reliability may be affected.

1. Repetitive Rating: Pulse width limited by maximum junction temperature.
2. I<sub>AS</sub> = 15 A, R<sub>G</sub> = 25 Ω, Starting T<sub>J</sub> = 25°C
3. I<sub>SD</sub> ≤ 38 A, di/dt ≤ 200 A/μs, V<sub>DD</sub> ≤ 380 V, Starting T<sub>J</sub> = 25 °C.

## PACKAGE MARKING AND ORDERING INFORMATION

Part Number	Top Mark	Package	Packing Method	Reel Size	Tape Width	Quantity
FCH041N65F-F155	FCH041N65F	TO-247-3LD	Tube	N/A	N/A	30 Units

## THERMAL CHARACTERISTICS

Symbol	Parameter	FCH041N65F-F155	Unit
R <sub>θJC</sub>	Thermal Resistance, Junction to Case, Max.	0.21	°C/W
R <sub>θJA</sub>	Thermal Resistance, Junction to Ambient, Max.	40	

# FCH041N65F

## ELECTRICAL CHARACTERISTICS (T<sub>C</sub> = 25°C unless otherwise noted)

Symbol	Parameter	Test Condition	Min.	Typ.	Max.	Unit
--------	-----------	----------------	------	------	------	------

### OFF CHARACTERISTICS

BV <sub>DSS</sub>	Drain to Source Breakdown Voltage	V <sub>GS</sub> = 0 V, I <sub>D</sub> = 10 mA, T <sub>J</sub> = 25°C	650	-	-	V
		V <sub>GS</sub> = 0 V, I <sub>D</sub> = 10 mA, T <sub>J</sub> = 150°C	700	-	-	
ΔBV <sub>DSS</sub> /ΔT <sub>J</sub>	Breakdown Voltage Temperature Coefficient	I <sub>D</sub> = 10 mA, Referenced to 25°C	-	0.72	-	V/°C
I <sub>DSS</sub>	Zero Gate Voltage Drain Current	V <sub>DS</sub> = 650 V, V <sub>GS</sub> = 0 V	-	-	10	μA
		V <sub>DS</sub> = 520 V, T <sub>C</sub> = 125°C	-	232	-	
I <sub>GSS</sub>	Gate to Body Leakage Current	V <sub>GS</sub> = ±20 V, V <sub>DS</sub> = 0 V	-	-	±100	nA

### ON CHARACTERISTICS

V <sub>GS(th)</sub>	Gate Threshold Voltage	V <sub>GS</sub> = V <sub>DS</sub> , I <sub>D</sub> = 7.6 mA	3	-	5	V
R <sub>DS(on)</sub>	Static Drain to Source On Resistance	V <sub>GS</sub> = 10 V, I <sub>D</sub> = 38 A	-	36	41	mΩ
g <sub>FS</sub>	Forward Transconductance	V <sub>DS</sub> = 20 V, I <sub>D</sub> = 38 A	-	18	-	S

### DYNAMIC CHARACTERISTICS

C <sub>iss</sub>	Input Capacitance	V <sub>DS</sub> = 100 V, V <sub>GS</sub> = 0 V, f = 1 MHz	-	9790	13020	pF
C <sub>oss</sub>	Output Capacitance		-	355	470	pF
C <sub>rss</sub>	Reverse Transfer Capacitance		-	32	-	pF
C <sub>oss</sub>	Output Capacitance	V <sub>DS</sub> = 380 V, V <sub>GS</sub> = 0 V, f = 1 MHz	-	192	-	pF
C <sub>oss(eff.)</sub>	Effective Output Capacitance	V <sub>DS</sub> = 0 V to 400 V, V <sub>GS</sub> = 0 V	-	1278	-	pF
Q <sub>g(tot)</sub>	Total Gate Charge at 10 V	V <sub>DD</sub> = 380 V, I <sub>D</sub> = 38 A, V <sub>GS</sub> = 10 V (Note 4)	-	226	294	nC
Q <sub>gs</sub>	Gate to Source Gate Charge		-	50	-	nC
Q <sub>gd</sub>	Gate to Drain "Miller" Charge		-	90	-	nC
ESR	Equivalent Series Resistance	f = 1 MHz	-	0.6	-	Ω

### SWITCHING CHARACTERISTICS

t <sub>d(on)</sub>	Turn-On Delay Time	V <sub>DD</sub> = 380 V, I <sub>D</sub> = 38 A, V <sub>GS</sub> = 10 V, R <sub>G</sub> = 4.7 Ω (Note 4)	-	60	130	ns
t <sub>r</sub>	Turn-On Rise Time		-	47	104	ns
t <sub>d(off)</sub>	Turn-Off Delay Time		-	190	390	ns
t <sub>f</sub>	Turn-Off Fall Time		-	6.5	23	ns

### DRAIN-SOURCE DIODE CHARACTERISTICS

I <sub>S</sub>	Maximum Continuous Drain to Source Diode Forward Current	-	-	76	A	
I <sub>SM</sub>	Maximum Pulsed Drain to Source Diode Forward Current	-	-	228	A	
V <sub>SD</sub>	Drain to Source Diode Forward Voltage	V <sub>GS</sub> = 0 V, I <sub>SD</sub> = 38 A	-	-	1.2	V
t <sub>rr</sub>	Reverse Recovery Time	V <sub>GS</sub> = 0 V, I <sub>SD</sub> = 38 A, dI <sub>F</sub> /dt = 100 A/μs	-	213	-	ns
Q <sub>rr</sub>	Reverse Recovery Charge		-	1.3	-	μC

Product parametric performance is indicated in the Electrical Characteristics for the listed test conditions, unless otherwise noted. Product performance may not be indicated by the Electrical Characteristics if operated under different conditions.

4. Essentially independent of operating temperature typical characteristics.

TYPICAL PERFORMANCE CHARACTERISTICS

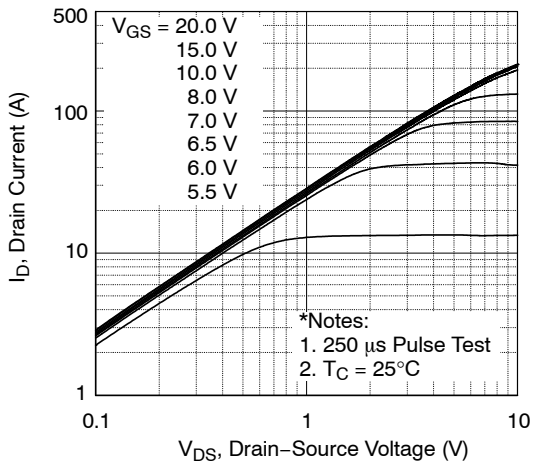

Figure 1. On-Region Characteristics

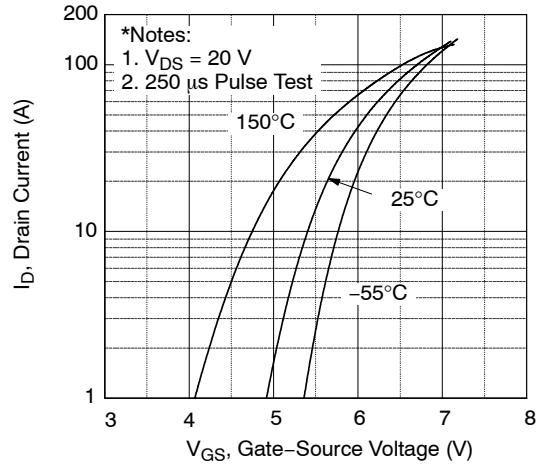

Figure 2. Transfer Characteristics

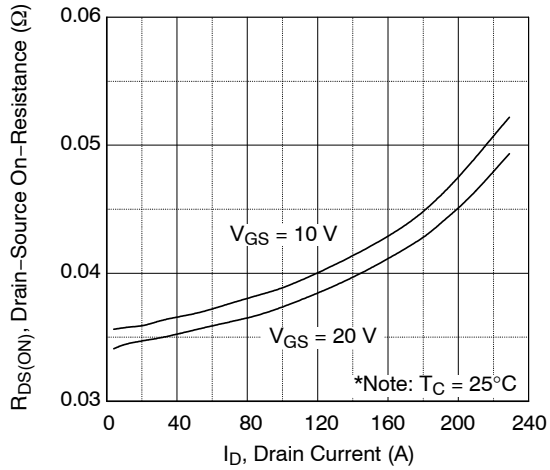

Figure 3. On-Resistance Variation vs. Drain Current and Gate Voltage

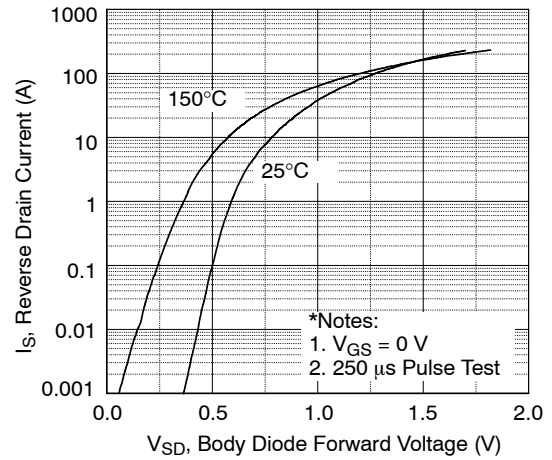

Figure 4. Body Diode Forward Voltage Variation vs. Source Current and Temperature

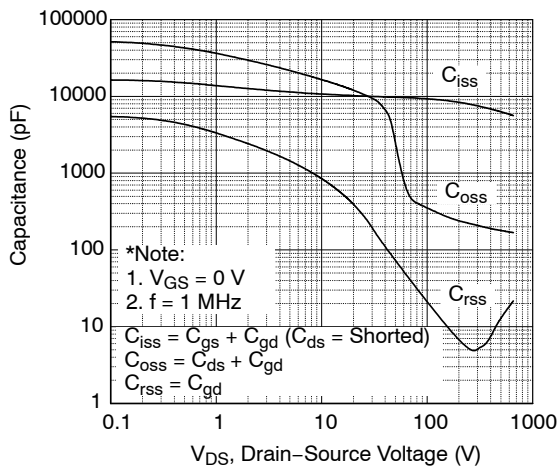

Figure 5. Capacitance Characteristics

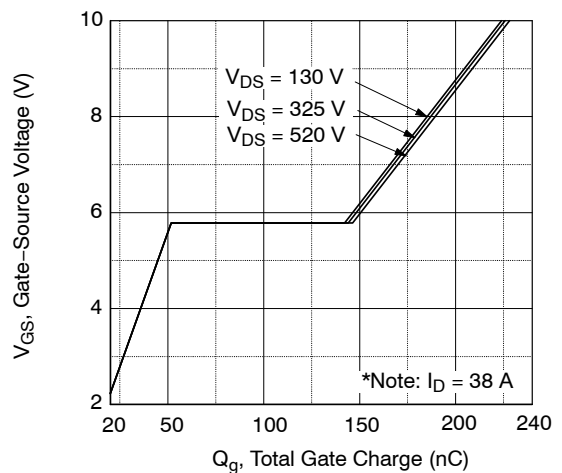

Figure 6. Gate Charge Characteristics

TYPICAL PERFORMANCE CHARACTERISTICS (continued)

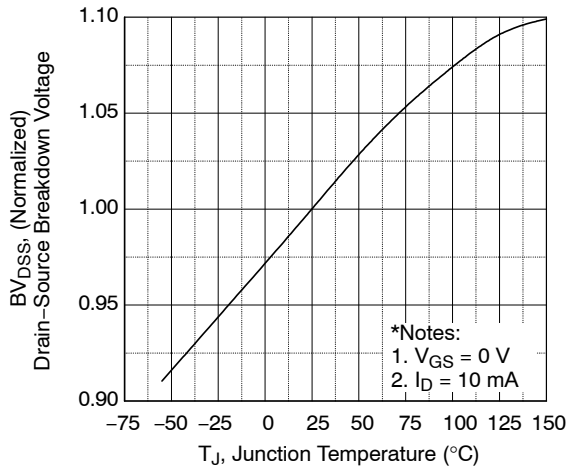

Figure 7. Breakdown Voltage Variation vs. Temperature

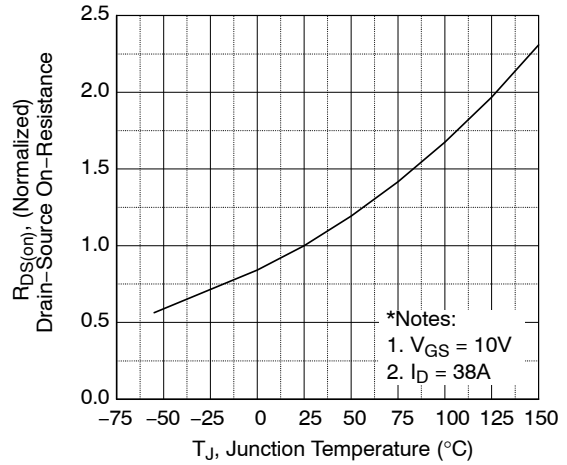

Figure 8. On-Resistance Variation vs. Temperature

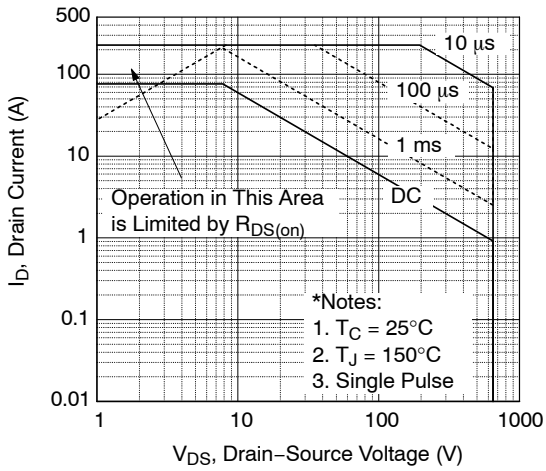

Figure 9. Maximum Safe Operating Area

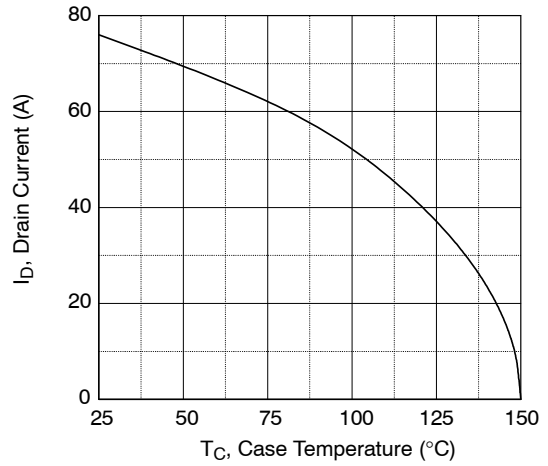

Figure 10. Maximum Drain Current vs. Case Temperature

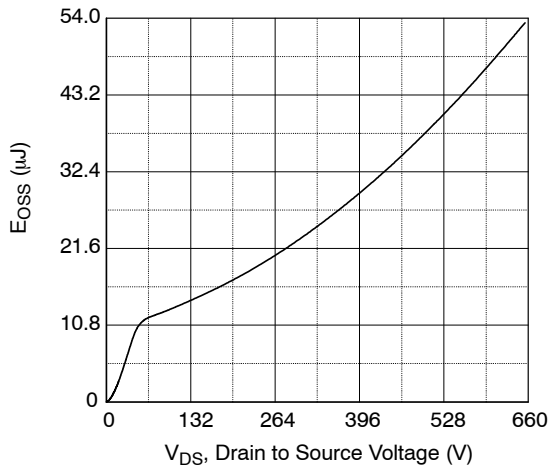

Figure 11.  $E_{OSS}$  vs. Drain to Source Voltage

# FCH041N65F

## TYPICAL PERFORMANCE CHARACTERISTICS (continued)

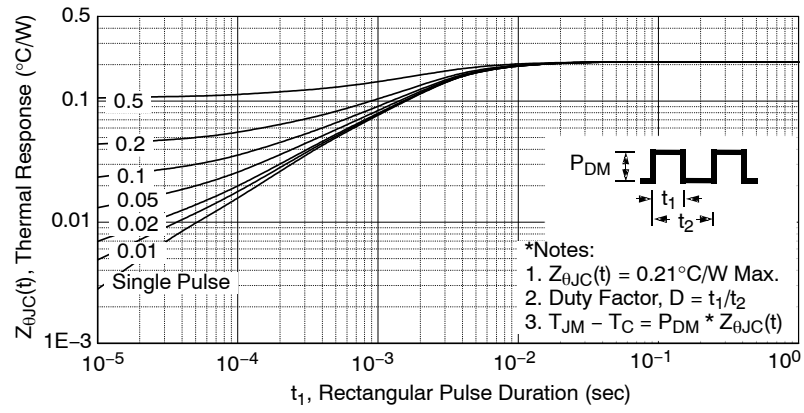

Figure 12. Transient Thermal Response Curve

# FCH041N65F

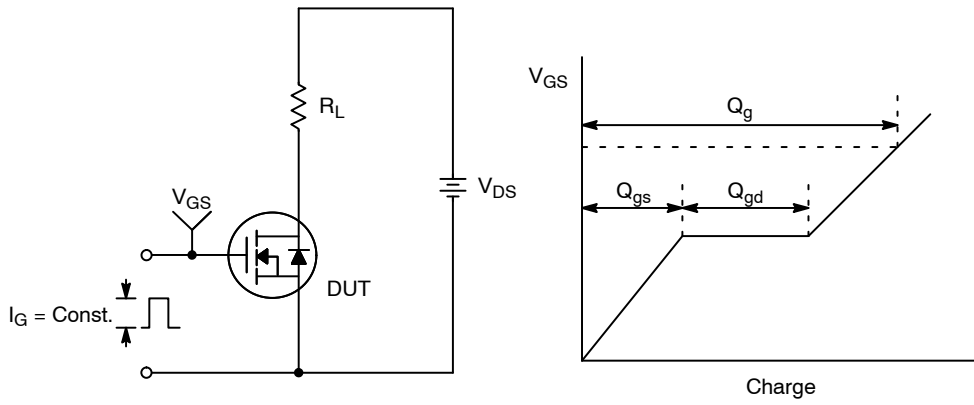

Figure 13. Gate Charge Test Circuit & Waveform

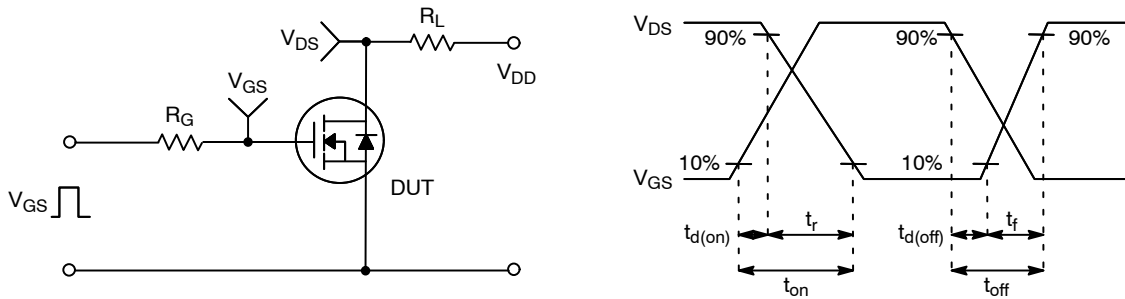

Figure 14. Resistive Switching Test Circuit & Waveforms

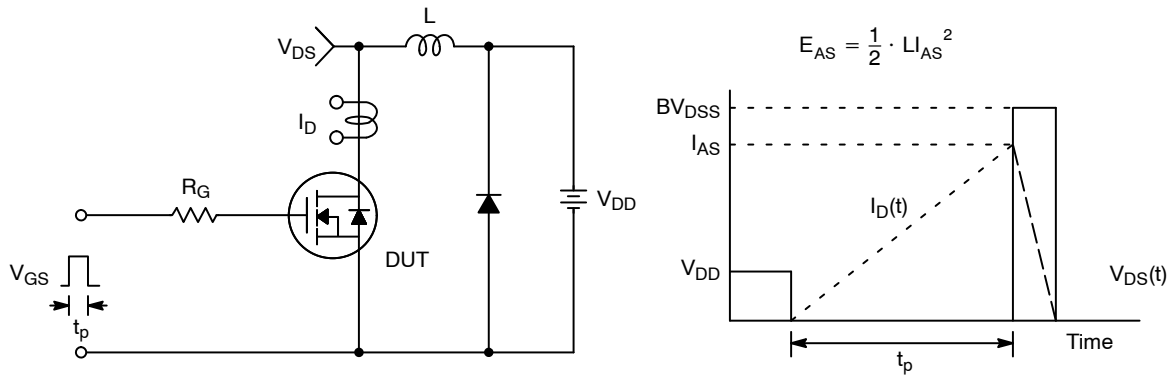
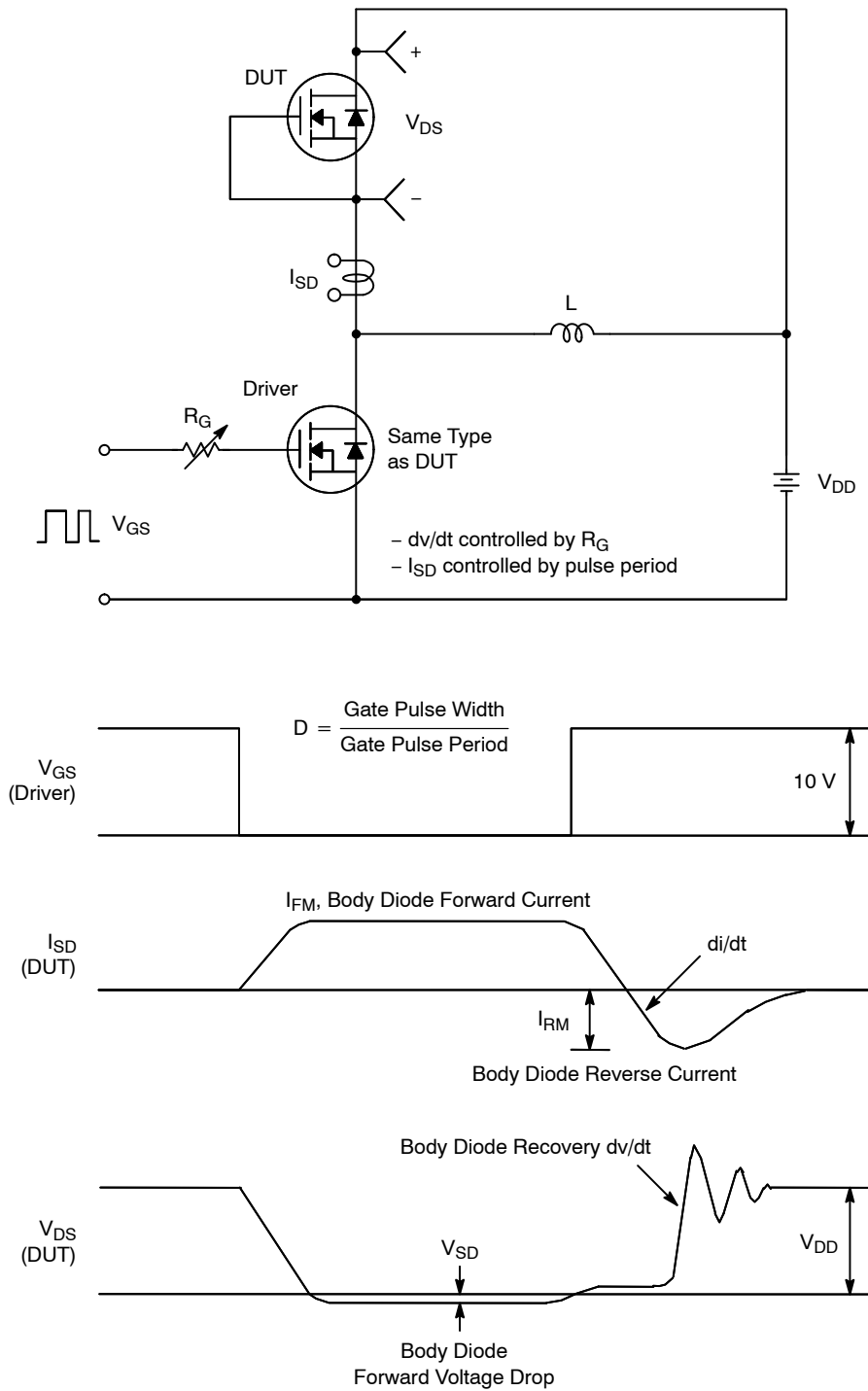

Figure 15. Unclamped Inductive Switching Test Circuit & Waveforms

# FCH041N65F



**Figure 16. Peak Diode Recovery  $dv/dt$  Test Circuit & Waveforms**

SUPERFET is a registered trademark of Semiconductor Components Industries, LLC (SCILLC) or its subsidiaries in the United States and/or other countries.

FRFET is a registered trademark of Semiconductor Components Industries, LLC (SCILLC) or its subsidiaries in the United States and/or other countries.



# MECHANICAL CASE OUTLINE PACKAGE DIMENSIONS

ON Semiconductor®



TO-247-3LD  
CASE 340CH  
ISSUE A

DATE 09 OCT 2019



NOTES: UNLESS OTHERWISE SPECIFIED.

- A. DIMENSIONS ARE EXCLUSIVE OF BURRS, MOLD FLASH, AND TIE BAR EXTRUSIONS.
- B. ALL DIMENSIONS ARE IN MILLIMETERS.
- C. DRAWING CONFORMS TO ASME Y14.5 - 2009.
- D. DIMENSION A1 TO BE MEASURED IN THE REGION DEFINED BY L1.
- E. LEAD FINISH IS UNCONTROLLED IN THE REGION DEFINED BY L1.

### GENERIC MARKING DIAGRAM\*

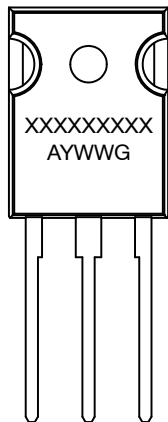

XXXX = Specific Device Code  
A = Assembly Location  
Y = Year  
WW = Work Week  
G = Pb-Free Package

\*This information is generic. Please refer to device data sheet for actual part marking. Pb-Free indicator, "G" or microdot "•", may or may not be present. Some products may not follow the Generic Marking.

DIM	MILLIMETERS		
	MIN	NOM	MAX
A	4.58	4.70	4.82
A1	2.29	2.475	2.66
A2	1.40	1.50	1.60
D	20.32	20.57	20.82
E	15.37	15.62	15.87
E2	4.96	5.08	5.20
e	~	5.56	~
L	19.75	20.00	20.25
L1	3.69	3.81	3.93
∅P	3.51	3.58	3.65
Q	5.34	5.46	5.58
S	5.34	5.46	5.58
b	1.17	1.26	1.35
b2	1.53	1.65	1.77
b4	2.42	2.54	2.66
c	0.51	0.61	0.71
D1	13.08	~	~
D2	0.51	0.93	1.35
E1	12.81	~	~
∅P1	6.61	6.73	6.85

DOCUMENT NUMBER:	98AON13853G	Electronic versions are uncontrolled except when accessed directly from the Document Repository. Printed versions are uncontrolled except when stamped "CONTROLLED COPY" in red.
DESCRIPTION:	TO-247-3LD	PAGE 1 OF 1

ON Semiconductor and are trademarks of Semiconductor Components Industries, LLC dba ON Semiconductor or its subsidiaries in the United States and/or other countries. ON Semiconductor reserves the right to make changes without further notice to any products herein. ON Semiconductor makes no warranty, representation or guarantee regarding the suitability of its products for any particular purpose, nor does ON Semiconductor assume any liability arising out of the application or use of any product or circuit, and specifically disclaims any and all liability, including without limitation special, consequential or incidental damages. ON Semiconductor does not convey any license under its patent rights nor the rights of others.

**onsemi**, **Onsemi**, and other names, marks, and brands are registered and/or common law trademarks of Semiconductor Components Industries, LLC dba "**onsemi**" or its affiliates and/or subsidiaries in the United States and/or other countries. **onsemi** owns the rights to a number of patents, trademarks, copyrights, trade secrets, and other intellectual property. A listing of **onsemi**'s product/patent coverage may be accessed at [www.onsemi.com/site/pdf/Patent-Marking.pdf](http://www.onsemi.com/site/pdf/Patent-Marking.pdf). **onsemi** reserves the right to make changes at any time to any products or information herein, without notice. The information herein is provided "as-is" and **onsemi** makes no warranty, representation or guarantee regarding the accuracy of the information, product features, availability, functionality, or suitability of its products for any particular purpose, nor does **onsemi** assume any liability arising out of the application or use of any product or circuit, and specifically disclaims any and all liability, including without limitation special, consequential or incidental damages. Buyer is responsible for its products and applications using **onsemi** products, including compliance with all laws, regulations and safety requirements or standards, regardless of any support or applications information provided by **onsemi**. "Typical" parameters which may be provided in **onsemi** data sheets and/or specifications can and do vary in different applications and actual performance may vary over time. All operating parameters, including "Typicals" must be validated for each customer application by customer's technical experts. **onsemi** does not convey any license under any of its intellectual property rights nor the rights of others. **onsemi** products are not designed, intended, or authorized for use as a critical component in life support systems or any FDA Class 3 medical devices or medical devices with a same or similar classification in a foreign jurisdiction or any devices intended for implantation in the human body. Should Buyer purchase or use **onsemi** products for any such unintended or unauthorized application, Buyer shall indemnify and hold **onsemi** and its officers, employees, subsidiaries, affiliates, and distributors harmless against all claims, costs, damages, and expenses, and reasonable attorney fees arising out of, directly or indirectly, any claim of personal injury or death associated with such unintended or unauthorized use, even if such claim alleges that **onsemi** was negligent regarding the design or manufacture of the part. **onsemi** is an Equal Opportunity/Affirmative Action Employer. This literature is subject to all applicable copyright laws and is not for resale in any manner.

## PUBLICATION ORDERING INFORMATION

### LITERATURE FULFILLMENT:

Email Requests to: [orderlit@onsemi.com](mailto:orderlit@onsemi.com)

**onsemi Website:** [www.onsemi.com](http://www.onsemi.com)

### TECHNICAL SUPPORT

**North American Technical Support:**

Voice Mail: 1 800-282-9855 Toll Free USA/Canada

Phone: 011 421 33 790 2910

**Europe, Middle East and Africa Technical Support:**

Phone: 00421 33 790 2910

For additional information, please contact your local Sales Representative