

EMI9408

PRAETORIAN® L-C LCD and Camera EMI Array with ESD Protection

Functional Description

The EMI9408 is an inductor-based (L-C) EMI filter array with ESD protection, which integrates eight filters in a uDFN package with 0.40 mm pitch. Each EMI filter channel of the EMI9408 is implemented with the component value of 1.8 pF–35 nH–4.7 pF–35 nH–6 pF. The cut-off frequency at 3dB attenuation is 300MHz and can be used in applications where the data rates are as high as 160 Mbps, while providing greater than –35 dB attenuation over the 800 MHz to 2.7 GHz frequency range. The parts include ESD diodes on every I/O pin and provide a high level of protection against electrostatic discharge (ESD). The ESD protection diodes connected to the external filter ports are designed and characterized to safely dissipate ESD strikes of ±14 kV, which is beyond the maximum requirement of the IEC61000–4–2 international standard.

This device is particularly well suited for wireless handsets, mobile LCD modules and PDAs because of its small package format and easy-to-use pin assignments. In particular, the EMI9408 is ideal for EMI filtering and protecting data and control lines for the LCD display and camera interface in mobile handsets.

The EMI9408 is housed in space saving, low profile, 0.40 mm pitch uDFN packages in a RoHS compliant, Pb-Free format.

Features

- Eight Channels of EMI Filtering with Integrated ESD Protection
- Pi-Style EMI Filters in a Capacitor-Inductor-Capacitor (C-L-C) Network
- ±14 kV ESD Protection (IEC 61000–4–2 Level 4, Contact Discharge) at External Pin
- Greater than –35 dB Attenuation (Typical) at 1 GHz
- uDFN Pb-Free Package with 0.40 mm Lead Pitch: 8-ch. = 16-lead uDFN
- uDFN Package Size: 16-Lead: 3.30 mm x 1.35 mm
- Increased Robustness Against Vertical Impacts During Manufacturing Process
- These Devices are Pb-Free and are RoHS Compliant

Applications

- LCD and Camera Data Lines in Mobile Handsets
- I/O Port Protection for Mobile Handsets, Notebook Computers, PDAs, etc.
- EMI Filtering for Data Ports in Cell Phones, PDAs or Notebook Computer
- Wireless Handsets
- Handheld PCs/PDAs
- LCD and Camera Modules



ON Semiconductor®

<http://onsemi.com>

MARKING DIAGRAMS

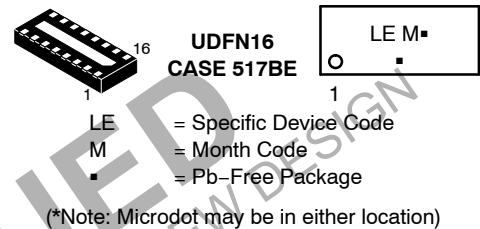

PINOUTS

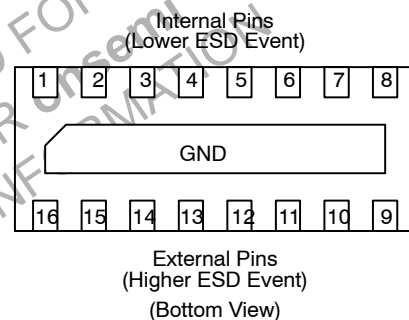

ORDERING INFORMATION

See detailed ordering and shipping information in the package dimensions section on page 3 of this data sheet.

EMI9408

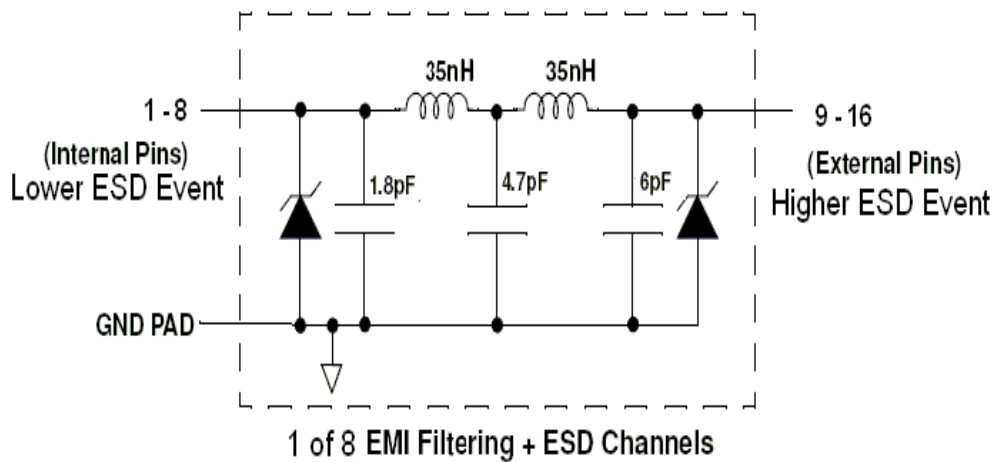

Figure 1. Electrical Schematic

Table 1. PIN DESCRIPTIONS

Pin #	Name	Description
1	FILTER1	Filter + ESD Channel 1 (Internal)
2	FILTER2	Filter + ESD Channel 2 (Internal)
3	FILTER3	Filter + ESD Channel 3 (Internal)
4	FILTER4	Filter + ESD Channel 4 (Internal)
5	FILTER5	Filter + ESD Channel 5 (Internal)
6	FILTER6	Filter + ESD Channel 6 (Internal)
7	FILTER7	Filter + ESD Channel 7 (Internal)
8	FILTER8	Filter + ESD Channel 8 (Internal)
9	FILTER8	Filter + ESD Channel 8 (External)
10	FILTER7	Filter + ESD Channel 7 (External)
11	FILTER6	Filter + ESD Channel 6 (External)
12	FILTER5	Filter + ESD Channel 5 (External)
13	FILTER4	Filter + ESD Channel 4 (External)
14	FILTER3	Filter + ESD Channel 3 (External)
15	FILTER2	Filter + ESD Channel 2 (External)
16	FILTER1	Filter + ESD Channel 1 (External)
GND PAD	GND	Device Ground

SPECIFICATIONS

MAXIMUM RATINGS

Parameter	Value	Unit
Storage Temperature Range	-65 to +150	°C
Current per Inductor	15	mA
DC Package Power Rating	500	mW

Stresses exceeding Maximum Ratings may damage the device. Maximum Ratings are stress ratings only. Functional operation above the Recommended Operating Conditions is not implied. Extended exposure to stresses above the Recommended Operating Conditions may affect device reliability.

STANDARD OPERATING CONDITIONS

Parameter	Rating	Unit
Operating Temperature Range	-40 to +85	°C

EMI9408

ELECTRICAL OPERATING CHARACTERISTICS (Note 1)

Symbol	Parameter	Conditions	Min	Typ	Max	Unit
L_{TOT}	Total Channel Inductance			70		nH
R_{TOT}	Total Channel DC Resistance			45		Ω
C_{TOT_0V}	Total Channel Capacitance, 0 V bias	0 V dc; 1 MHz, 30 mV _{rms}		17.5	24	pF
$C_{TOT_2.5V}$	Total Channel Capacitance, 2.5 V bias	2.5 V dc; 1 MHz, 30 mV _{rms}		11.5		pF
V_{ST}	Stand-off Voltage	$I = 10 \mu A$	5.5			V
I_{LEAK}	Diode Leakage Current	$V_{IN} = +3.3 V$		0.1	0.5	μA
V_{SIG}	Signal Clamp Voltage Positive Clamp Negative Clamp	$I_{LOAD} = 10 mA$ $I_{LOAD} = -10 mA$	5.6 -1.5	6.8 -0.8	9.0 -0.4	V
V_{ESD}	In-system ESD Withstand Voltage a) Contact discharge per IEC 61000-4-2 standard, Level 4 (External Pins) b) Contact discharge per IEC 61000-4-2 standard, Level 4 (Internal Pins) c) Air Discharge per IEC61000-4-2 standard, Level 4 (External Pins)	Notes 2 and 3	± 14 ± 2 ± 16			kV
V_C	Clamping Voltage TLP (Note 4) See Figures 4 through 7	$I_{PP} = 8 A$ $I_{PP} = 16 A$ $I_{PP} = -8 A$ $I_{PP} = -16 A$		13.7 20 -4.4 -7.6		V
f_c	Cut-off frequency $Z_{SOURCE} = 50 \Omega$, $Z_{LOAD} = 50 \Omega$			345		MHz

- $T_A = 25^\circ C$ unless otherwise specified.
- ESD applied to input and output pins with respect to GND, one at a time.
- Unused pins are left open.
- ANSI/ESD STM5.5.1 – Electrostatic Discharge Sensitivity Testing using Transmission Line Pulse (TLP) Model.
TLP conditions: $Z_0 = 50 \Omega$, $t_p = 100 ns$, $t_r = 4 ns$, averaging window; $t_1 = 30 ns$ to $t_2 = 60 ns$.

PERFORMANCE INFORMATION

TYPICAL FILTER PERFORMANCE

($T_A = 25^\circ C$, DC Bias = 0 V, 50 Ω Environment)

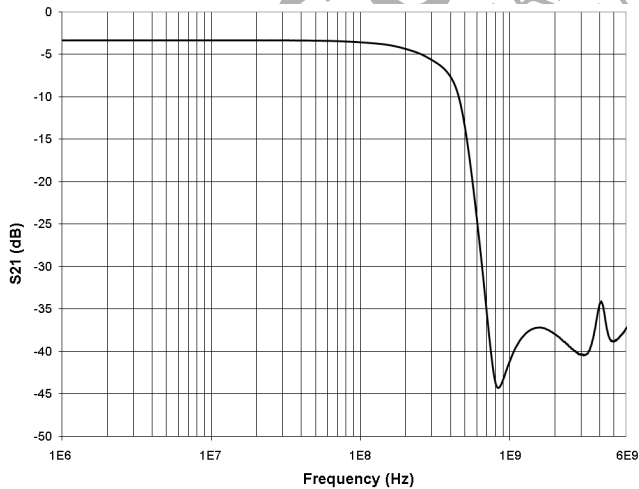

Figure 2. Typical Filter Insertion Loss

TYPICAL DIODE CAPACITANCE VS. INPUT VOLTAGE

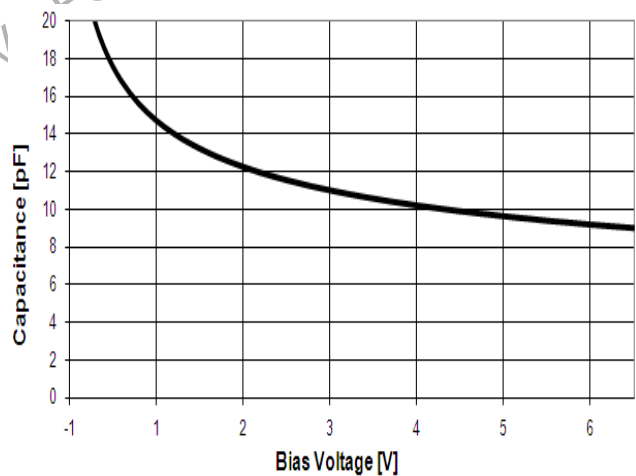

Figure 3. Filter Capacitance vs. Input Voltage (Normalized to Capacitance at 0 VDC and 25°C)

ORDERING INFORMATION

Device	Pins	Marking	Package	Shipping [†]
EMI9408MUTAG	16	LE	UDFN16 (Pb-Free)	3000 / Tape & Reel

[†]For information on tape and reel specifications, including part orientation and tape sizes, please refer to our Tape and Reel Packaging Specifications Brochure, BRD8011/D.

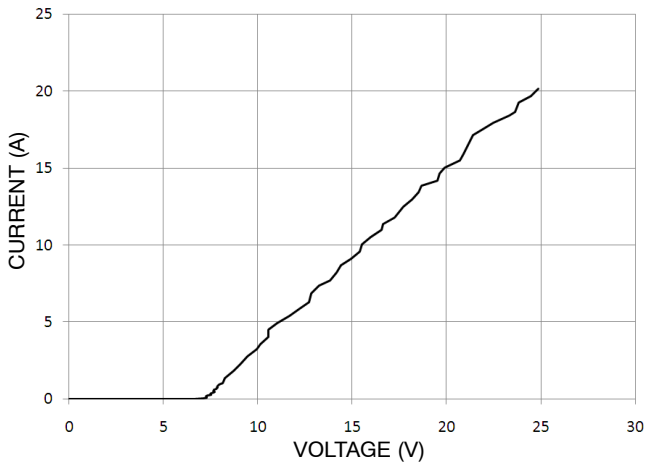

Figure 4. Positive TLP I-V Curve

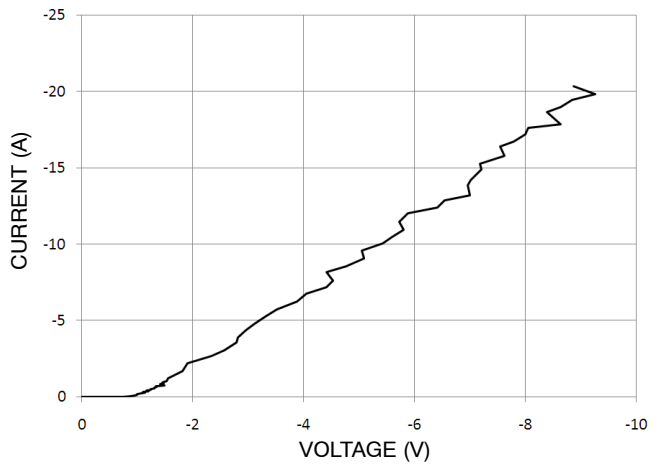

Figure 5. Negative TLP I-V Curve

Transmission Line Pulse (TLP) Measurement

Transmission Line Pulse (TLP) provides current versus voltage (I-V) curves in which each data point is obtained from a 100 ns long rectangular pulse from a charged transmission line. A simplified schematic of a typical TLP system is shown in Figure 6. TLP I-V curves of ESD protection devices accurately demonstrate the product’s ESD capability because the 10s of amps current levels and under 100 ns time scale match those of an ESD event. This is illustrated in Figure 7 where an 8 kV IEC 61000-4-2 current waveform into a short is compared with TLP current pulses at 8 A and 16 A, also into a short. A TLP I-V curve shows the voltage at which the device turns on, as well as how well the device clamps voltage over a range of current levels. Typical TLP I-V curves for the EMI9404 are shown in Figures 4 and 5 for positive and negative stress respectively. Application note AND9007/D gives more

detail on TLP datasheet parameters, while application note AND9006/D provides a more complete explanation of the use of TLP for understanding protection product characteristics.

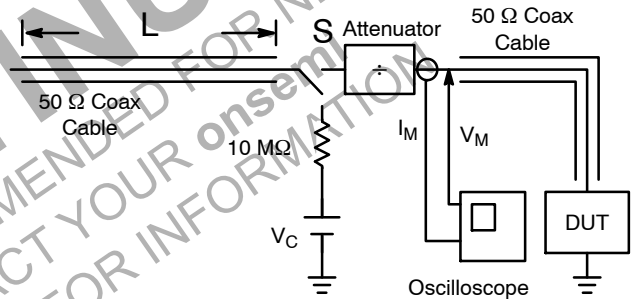

Figure 6. Simplified Schematic of a Typical TLP System

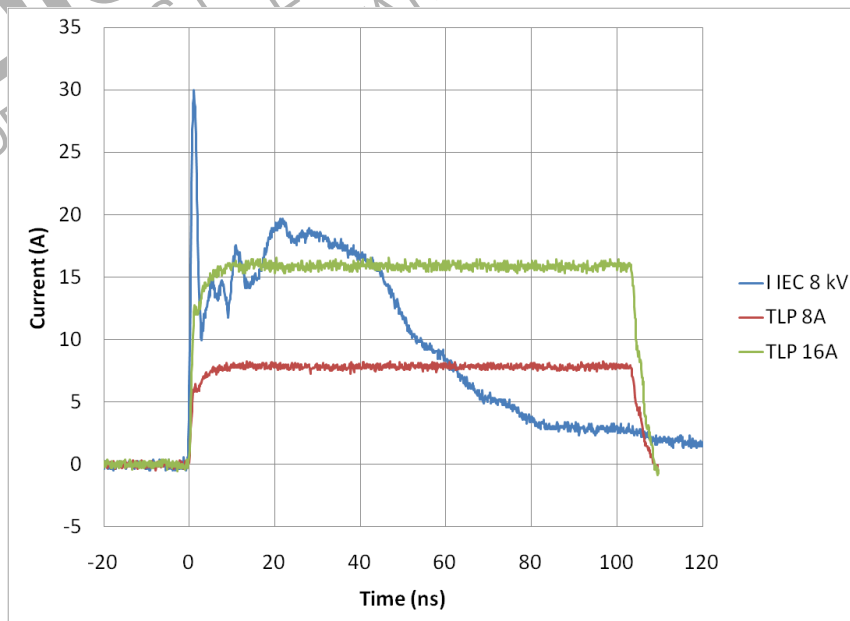
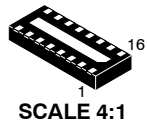
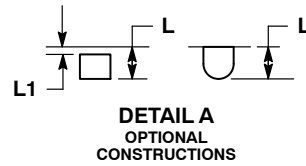
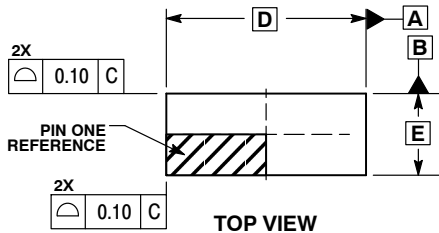

Figure 7. Comparison Between 8 kV IEC 61000-4-2 and 8 A and 16 A TLP Waveforms



UDFN16, 3.3x1.35, 0.4P
CASE 517BE
ISSUE O

DATE 18 NOV 2009



- NOTES:
1. DIMENSIONING AND TOLERANCING PER ASME Y14.5M, 1994.
 2. CONTROLLING DIMENSION: MILLIMETERS.
 3. DIMENSION b APPLIES TO PLATED TERMINAL AND IS MEASURED BETWEEN 0.15 AND 0.25 mm FROM THE TERMINAL TIP.
 4. COPLANARITY APPLIES TO THE EXPOSED PAD AS WELL AS THE TERMINALS.

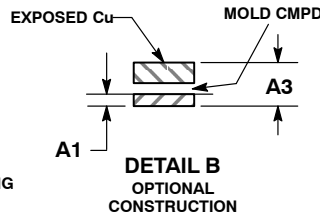
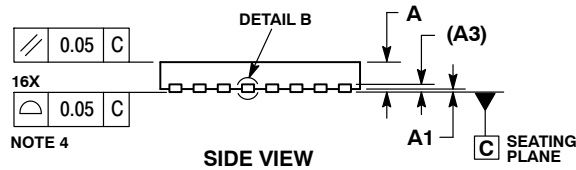

MILLIMETERS		
DIM	MIN	MAX
A	0.45	0.55
A1	0.00	0.05
A3	0.13	REF
b	0.15	0.25
D	3.30	BSC
D2	2.70	2.90
E	1.35	BSC
E2	0.30	0.50
e	0.40	BSC
K	0.15	---
L	0.20	0.30
L1	---	0.05

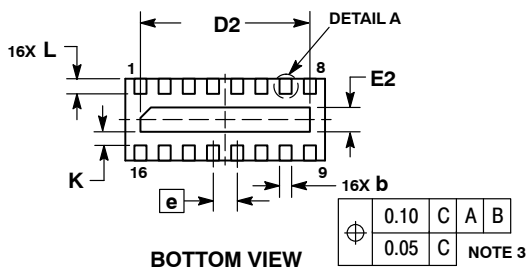

GENERIC MARKING DIAGRAM*

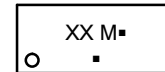

1

- XX = Specific Device Code
M = Month Code
▪ = Pb-Free Package

(Note: Microdot may be in either location)

*This information is generic. Please refer to device data sheet for actual part marking.

Pb-Free indicator, "G" or microdot "▪", may or may not be present.

RECOMMENDED SOLDERING FOOTPRINT*

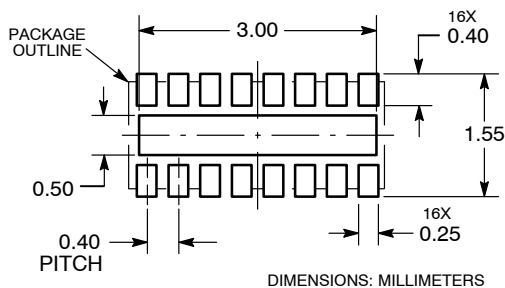

*For additional information on our Pb-Free strategy and soldering details, please download the **onsemi** Soldering and Mounting Techniques Reference Manual, SOLDERRM/D.

DOCUMENT NUMBER:	98AON47062E	Electronic versions are uncontrolled except when accessed directly from the Document Repository. Printed versions are uncontrolled except when stamped "CONTROLLED COPY" in red.
DESCRIPTION:	UDFN16, 3.3X1.35, 0.4P	PAGE 1 OF 1

onsemi and **ONsemi** are trademarks of Semiconductor Components Industries, LLC dba **onsemi** or its subsidiaries in the United States and/or other countries. **onsemi** reserves the right to make changes without further notice to any products herein. **onsemi** makes no warranty, representation or guarantee regarding the suitability of its products for any particular purpose, nor does **onsemi** assume any liability arising out of the application or use of any product or circuit, and specifically disclaims any and all liability, including without limitation special, consequential or incidental damages. **onsemi** does not convey any license under its patent rights nor the rights of others.

onsemi, **Onsemi**, and other names, marks, and brands are registered and/or common law trademarks of Semiconductor Components Industries, LLC dba "**onsemi**" or its affiliates and/or subsidiaries in the United States and/or other countries. **onsemi** owns the rights to a number of patents, trademarks, copyrights, trade secrets, and other intellectual property. A listing of **onsemi**'s product/patent coverage may be accessed at www.onsemi.com/site/pdf/Patent-Marking.pdf. **onsemi** reserves the right to make changes at any time to any products or information herein, without notice. The information herein is provided "as-is" and **onsemi** makes no warranty, representation or guarantee regarding the accuracy of the information, product features, availability, functionality, or suitability of its products for any particular purpose, nor does **onsemi** assume any liability arising out of the application or use of any product or circuit, and specifically disclaims any and all liability, including without limitation special, consequential or incidental damages. Buyer is responsible for its products and applications using **onsemi** products, including compliance with all laws, regulations and safety requirements or standards, regardless of any support or applications information provided by **onsemi**. "Typical" parameters which may be provided in **onsemi** data sheets and/or specifications can and do vary in different applications and actual performance may vary over time. All operating parameters, including "Typicals" must be validated for each customer application by customer's technical experts. **onsemi** does not convey any license under any of its intellectual property rights nor the rights of others. **onsemi** products are not designed, intended, or authorized for use as a critical component in life support systems or any FDA Class 3 medical devices or medical devices with a same or similar classification in a foreign jurisdiction or any devices intended for implantation in the human body. Should Buyer purchase or use **onsemi** products for any such unintended or unauthorized application, Buyer shall indemnify and hold **onsemi** and its officers, employees, subsidiaries, affiliates, and distributors harmless against all claims, costs, damages, and expenses, and reasonable attorney fees arising out of, directly or indirectly, any claim of personal injury or death associated with such unintended or unauthorized use, even if such claim alleges that **onsemi** was negligent regarding the design or manufacture of the part. **onsemi** is an Equal Opportunity/Affirmative Action Employer. This literature is subject to all applicable copyright laws and is not for resale in any manner.

ADDITIONAL INFORMATION

TECHNICAL PUBLICATIONS:

Technical Library: www.onsemi.com/design/resources/technical-documentation
onsemi Website: www.onsemi.com

ONLINE SUPPORT: www.onsemi.com/support

For additional information, please contact your local Sales Representative at www.onsemi.com/support/sales