

EMI5204MU, EMI5206MU, EMI5208MU



ON Semiconductor®

<http://onsemi.com>

Four-Six-Eight-Channel EMI Filter with Integrated ESD Protection

The EMI520xMU Series are a 4, 6, 8-channel (C-R-C) Pi-style EMI filter array with integrated ESD protection. Its typical component values of $R = 100 \Omega$ and $C = 7 \text{ pF}$ deliver a cutoff frequency of 250 MHz and stop band attenuation greater than 20 dB from 800 MHz to 5.0 GHz.

This performance makes the part ideal for parallel interfaces with data rates up to 167 Mbps in applications where wireless interference must be minimized. The specified attenuation range is very effective in minimizing interference from 2G/3G, GPS, Bluetooth® and WLAN signals.

The EMI520xMU Series is available in the low-profile 4, 6, 8-lead, 0.5mm thick UDFN packages with 0.4mm lead pitch.

Features/Benefits

- $\pm 8.0 \text{ kV}$ ESD Protection on each channel (IEC61000-4-2 Level 4, Contact Discharge)
- R/C Values of 100Ω and 7 pF deliver Exceptional S21 Performance Characteristics of 250 MHz $f_{3\text{dB}}$ and 20 dB Stop Band Attenuation from 800 MHz to 5.0 GHz
- Integrated EMI/ESD System Solution in UDFN Package Offers Exceptional Cost, System Reliability and Space Savings
- This is a Pb-Free Device

Applications

- EMI Filtering for LCD and Camera Data Lines
- EMI Filtering and Protection for I/O Ports and Keypads

MARKING DIAGRAMS



UDFN8
CASE 517BC

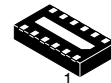
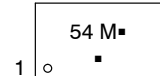

UDFN12
CASE 517BD

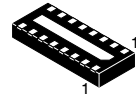
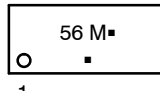

UDFN16
CASE 517BE

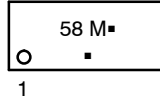

XX = Specific Device Code
M = Date Code
▪ = Pb-Free Package

(*Note: Microdot may be in either location)

ORDERING INFORMATION

See detailed ordering and shipping information in the package dimensions section on page 4 of this data sheet.

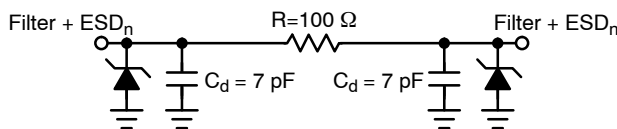

See Table 1 for pin description

Figure 1. Electrical Schematic

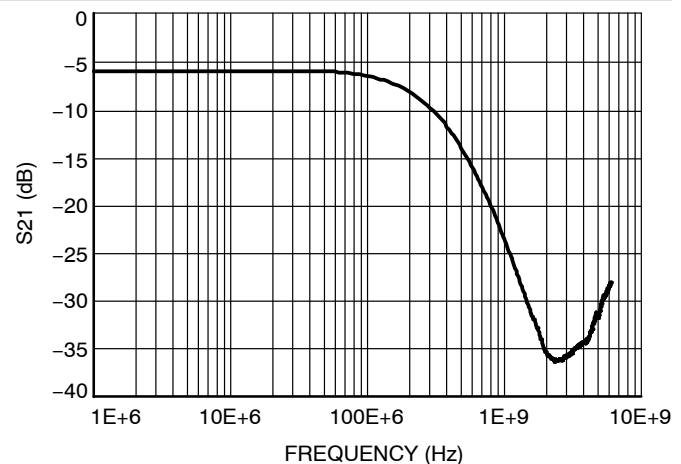

Figure 2. Typical Insertion Loss Curve

EMI5204MU, EMI5206MU, EMI5208MU

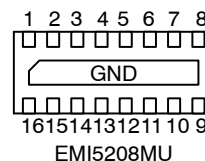
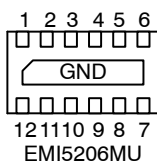
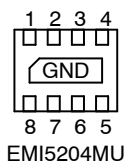

Figure 3. Pin Diagram
(Bottom View)

Table 1. FUNCTIONAL PIN DESCRIPTION

Filter	Device Pins			Description
	EMI5204MU	EMI5206MU	EMI5208MU	
Filter 1	1 & 8	1 & 12	1 & 16	Filter + ESD Channel 1
Filter 2	2 & 7	2 & 11	2 & 15	Filter + ESD Channel 2
Filter 3	3 & 6	3 & 10	3 & 14	Filter + ESD Channel 3
Filter 4	4 & 5	4 & 9	4 & 13	Filter + ESD Channel 4
Filter 5		5 & 8	5 & 12	Filter + ESD Channel 5
Filter 6		6 & 7	6 & 11	Filter + ESD Channel 6
Filter 7			7 & 10	Filter + ESD Channel 7
Filter 8			8 & 9	Filter + ESD Channel 8
Ground Pad	GND	GND	GND	Ground

MAXIMUM RATINGS

Parameter	Symbol	Value	Unit
ESD Discharge IEC61000-4-2 Contact Discharge	V_{PP}	8.0	kV
Operating Temperature Range	T_{OP}	-40 to 85	°C
Storage Temperature Range	T_{STG}	-55 to 150	°C
Maximum Lead Temperature for Soldering Purposes (1.8 in from case for 10 seconds)	T_L	260	°C

Stresses exceeding Maximum Ratings may damage the device. Maximum Ratings are stress ratings only. Functional operation above the Recommended Operating Conditions is not implied. Extended exposure to stresses above the Recommended Operating Conditions may affect device reliability.

ELECTRICAL CHARACTERISTICS ($T_J = 25^\circ\text{C}$ unless otherwise noted)

Parameter	Symbol	Test Conditions	Min	Typ	Max	Unit
Maximum Reverse Working Voltage	V_{RWM}				5.0	V
Breakdown Voltage	V_{BR}	$I_R = 1.0 \text{ mA}$	6.0	7.0	8.0	V
Leakage Current	I_R	$V_{RWM} = 3.3 \text{ V}$			100	nA
Resistance	R_A	$I_R = 10 \text{ mA}$	85	100	115	Ω
Diode Capacitance	C_d	$V_R = 2.5 \text{ V}, f = 1.0 \text{ MHz}$		7.0	11	pF
Line Capacitance	C_L	$V_R = 2.5 \text{ V}, f = 1.0 \text{ MHz}$		14	22	pF
3 dB Cut-Off Frequency (Note 1)	f_{3dB}	Above this frequency, appreciable attenuation occurs		250		MHz

1. 50 Ω source and 50 Ω load termination.

Theory of Operation

The EMI520x combines ESD protection and EMI filtering conveniently into a small package for today’s size constrained applications. The capacitance inherent to a typical protection diode is utilized to provide the capacitance value necessary to create the desired frequency response based upon the series resistance in the filter. By combining this functionality into one device, a large number of discrete components are integrated into one small package saving valuable board space and reducing BOM count and cost in the application.

Application Example

The accepted practice for specifying bandwidth in a filter is to use the 3 dB cutoff frequency. Utilizing points such as the 6 dB or 9 dB cutoff frequencies results in signal degradation in an application. This can be illustrated in an application example. A typical application would include EMI filtering of data lines in a camera or display interface. In such an example it is important to first understand the signal and its spectral content. By understanding these things, an appropriate filter can be selected for the desired application. A typical data signal is pattern of 1’s and 0’s transmitted over a line in a form similar to a square wave. The maximum frequency of such a signal would be the pattern 1–0–1–0 such that for a signal with a data rate of 100 Mbps, the maximum frequency component would be 50 MHz. The next item to consider is the spectral content of the signal, which can be understood with the Fourier series approximation of a square wave, shown below in Equations 1 and 2 in the Fourier series approximation.

From this it can be seen that a square wave consists of odd order harmonics and to fully construct a square wave n must go to infinity. However, to retain an acceptable portion of the waveform, the first two terms are generally sufficient. These two terms contain about 85% of the signal amplitude and allow a reasonable square wave to be reconstructed. Therefore, to reasonably pass a square wave of frequency x the minimum filter bandwidth necessary is 3x. All ON Semiconductor EMI filters are rated according to this principle. Attempting to violate this principle will result in significant rounding of the waveform and cause problems in transmitting the correct data. For example, take the filter with the response shown in Figure 4 and apply three different data waveforms. To calculate these three different frequencies, the 3 dB, 6 dB, and 9 dB bandwidths will be used.

Equation 1:

$$x(t) = \frac{1}{2} + \frac{2}{\pi} \sum_{n=1}^{\infty} \left[\frac{1}{2n-1} \sin((2n-1)\omega_0 t) \right] \quad (\text{eq. 1})$$

Equation 2 (Simplified form of Equation 1):

$$x(t) = \frac{1}{2} + \frac{2}{\pi} \left[\frac{\sin(\omega_0 t)}{1} + p20 \frac{\sin(3\omega_0 t)}{3} + p20 \frac{\sin(5\omega_0 t)}{5} + \dots \right] \quad (\text{eq. 2})$$

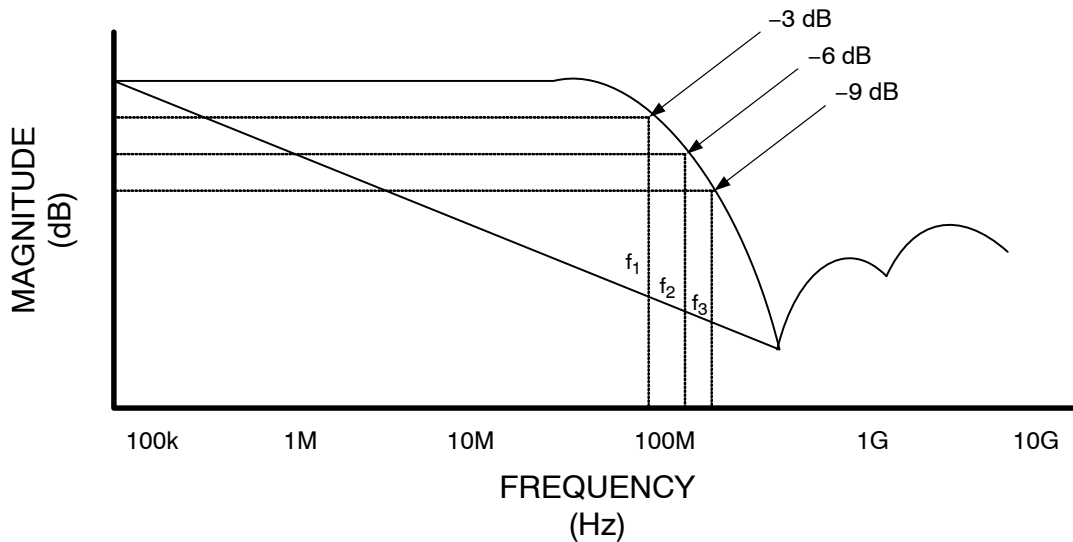

Figure 4. Filter Bandwidth

From the above paragraphs it is shown that the maximum supported frequency of a waveform that can be passed through the filter can be found by dividing the bandwidth by a factor of three (to obtain the corresponding data rate

multiply the result by two). The following table gives the bandwidth values and the corresponding maximum supported frequencies and the third harmonic frequencies.

EMI5204MU, EMI5206MU, EMI5208MU

Table 2. FREQUENCY CHART

Bandwidth	Maximum Supported Frequency	Third Harmonic Frequency
3 dB – 100 MHz	33.33 MHz (f_1)	100 MHz
6 dB – 200 MHz	66.67 MHz (f_2)	200 MHz
9 dB – 300 MHz	100 MHz (f_3)	300 MHz

Considering that 85% of the amplitude of the square is in the first two terms of the Fourier series approximation most of the signal content is at the fundamental (maximum supported) frequency and the third harmonic frequency. If a signal with a frequency of 33.33 MHz is input to this filter, the first two terms are sufficiently passed such that the signal is only mildly affected, as is shown in Figure 5a. If a signal with a frequency of 66.67 MHz is input to this same filter,

the third harmonic term is significantly attenuated. This serves to round the signal edges and skew the waveform, as is shown in Figure 5b. In the case that a 100 MHz signal is input to this filter, the third harmonic term is attenuated even further and results in even more rounding of the signal edges as is shown in Figure 5c. The result is the degradation of the data being transmitted making the digital data (1's and 0's) more difficult to discern. This does not include effects of other components such as interconnect and other path losses which could further serve to degrade the signal integrity. While some filter products may specify the 6 dB or 9 dB bandwidths, actually using these to calculate supported frequencies (and corresponding data rates) results in significant signal degradation. To ensure the best signal integrity possible, it is best to use the 3 dB bandwidth to calculate the achievable data rate.

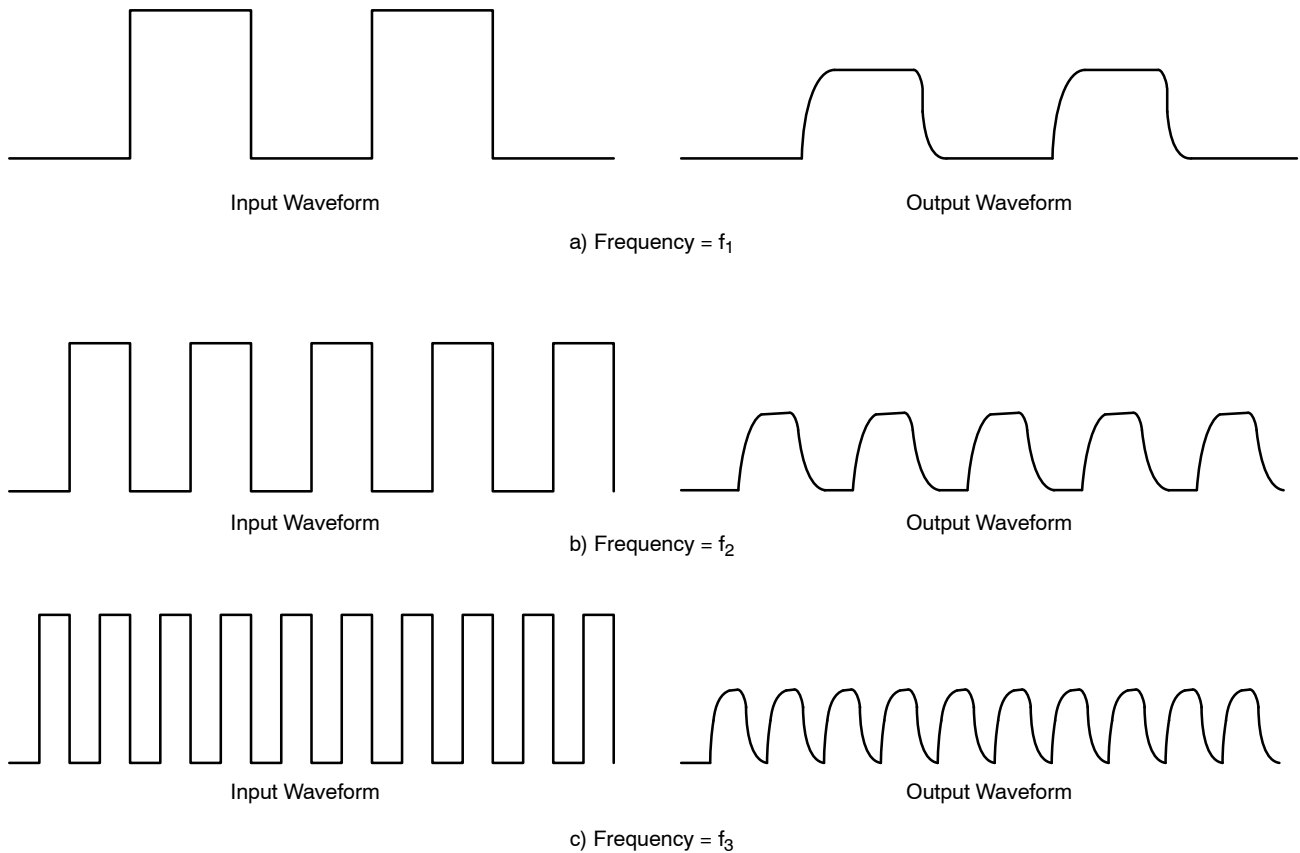

Figure 5. Input and Output Waveforms of Filter

ORDERING INFORMATION

Device	Package	Shipping†
EMI5204MUTAG	UDFN8 (Pb-Free)	3000 / Tape & Reel
EMI5206MUTAG	UDFN12 (Pb-Free)	3000 / Tape & Reel
EMI5208MUTAG	UDFN16 (Pb-Free)	3000 / Tape & Reel

†For information on tape and reel specifications, including part orientation and tape sizes, please refer to our Tape and Reel Packaging Specifications Brochure, BRD8011/D.

MECHANICAL CASE OUTLINE

PACKAGE DIMENSIONS

ON Semiconductor®

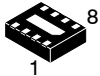

SCALE 4:1

UDFN8, 1.7x1.35, 0.4P
CASE 517BC-01
ISSUE O

DATE 17 NOV 2009

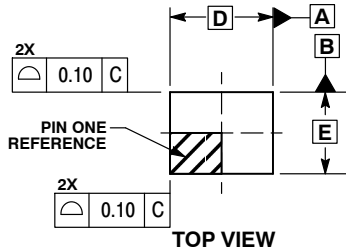

TOP VIEW

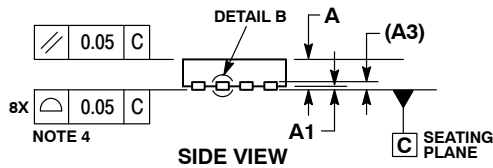

SIDE VIEW

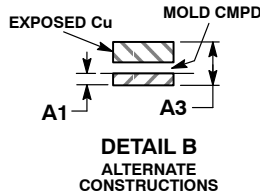

DETAIL B
ALTERNATE
CONSTRUCTIONS

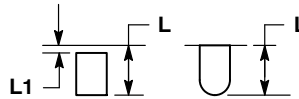

DETAIL A
ALTERNATE TERMINAL
CONSTRUCTIONS

NOTES:

1. DIMENSIONING AND TOLERANCING PER ASME Y14.5M, 1994.
2. CONTROLLING DIMENSION: MILLIMETERS.
3. DIMENSION b APPLIES TO PLATED TERMINAL AND IS MEASURED BETWEEN 0.15 AND 0.25 mm FROM THE TERMINAL TIP.
4. COPLANARITY APPLIES TO THE EXPOSED PAD AS WELL AS THE TERMINALS.

MILLIMETERS		
DIM	MIN	MAX
A	0.45	0.55
A1	0.00	0.05
A3	0.13	REF
b	0.15	0.25
D	1.70	BSC
D2	1.10	1.30
E	1.35	BSC
E2	0.30	0.50
e	0.40	BSC
K	0.15	---
L	0.20	0.30
L1	---	0.05

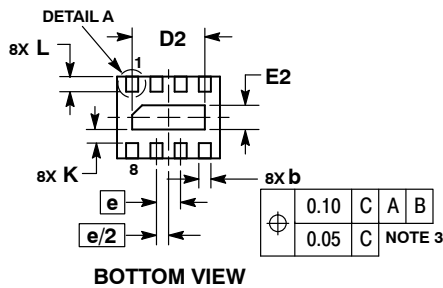

BOTTOM VIEW

RECOMMENDED
SOLDERING FOOTPRINT*

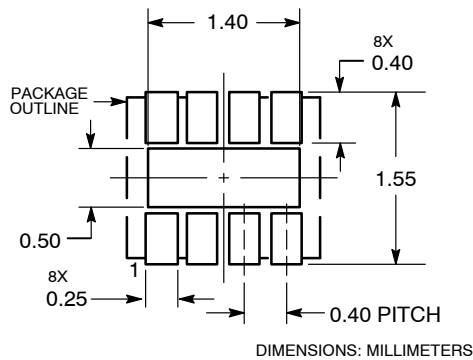

GENERIC
MARKING DIAGRAM*

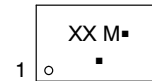

- XX = Specific Device Code
- M = Date Code
- = Pb-Free Package

(Note: Microdot may be in either location)

*This information is generic. Please refer to device data sheet for actual part marking. Pb-Free indicator, "G", may or not be present.

*For additional information on our Pb-Free strategy and soldering details, please download the ON Semiconductor Soldering and Mounting Techniques Reference Manual, SOLDERRM/D.

DOCUMENT NUMBER:	98AON47060E	Electronic versions are uncontrolled except when accessed directly from the Document Repository. Printed versions are uncontrolled except when stamped "CONTROLLED COPY" in red.
DESCRIPTION:	8 PIN UDFN, 1.7X1.35, 0.4P	PAGE 1 OF 1

ON Semiconductor and ON are trademarks of Semiconductor Components Industries, LLC dba ON Semiconductor or its subsidiaries in the United States and/or other countries. ON Semiconductor reserves the right to make changes without further notice to any products herein. ON Semiconductor makes no warranty, representation or guarantee regarding the suitability of its products for any particular purpose, nor does ON Semiconductor assume any liability arising out of the application or use of any product or circuit, and specifically disclaims any and all liability, including without limitation special, consequential or incidental damages. ON Semiconductor does not convey any license under its patent rights nor the rights of others.

MECHANICAL CASE OUTLINE

PACKAGE DIMENSIONS

ON Semiconductor®

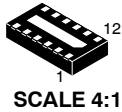

UDFN12, 2.5x1.35, 0.4P CASE 517BD-01 ISSUE O

DATE 18 NOV 2009

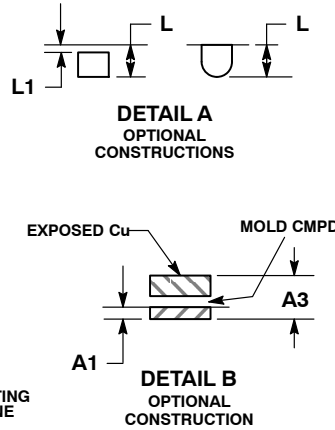
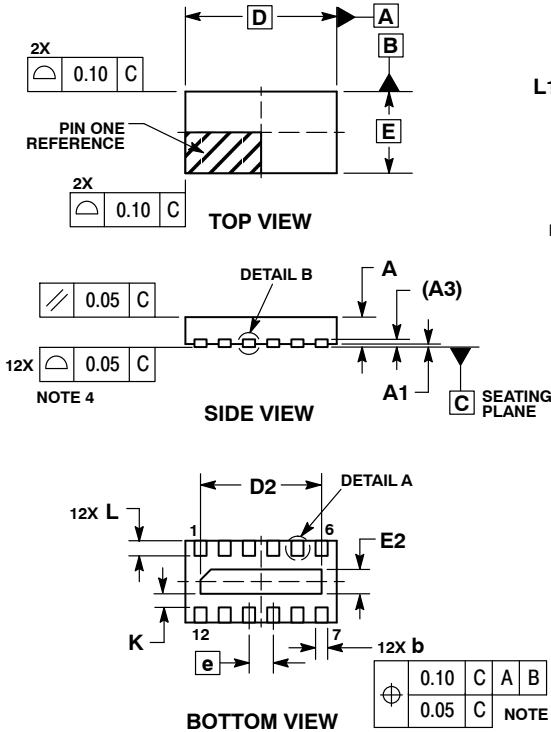

- NOTES:
1. DIMENSIONING AND TOLERANCING PER ASME Y14.5M, 1994.
 2. CONTROLLING DIMENSION: MILLIMETERS.
 3. DIMENSION b APPLIES TO PLATED TERMINAL AND IS MEASURED BETWEEN 0.15 AND 0.25 mm FROM THE TERMINAL TIP.
 4. COPLANARITY APPLIES TO THE EXPOSED PAD AS WELL AS THE TERMINALS.

MILLIMETERS		
DIM	MIN	MAX
A	0.45	0.55
A1	0.00	0.05
A3	0.13	REF
b	0.15	0.25
D	2.50	BSC
D2	1.90	2.10
E	1.35	BSC
E2	0.30	0.50
e	0.40	BSC
K	0.15	---
L	0.20	0.30
L1	---	0.05

GENERIC MARKING DIAGRAM*

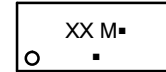

1

- XX = Specific Device Code
- M = Month Code
- = Pb-Free Package

(Note: Microdot may be in either location)

*This information is generic. Please refer to device data sheet for actual part marking.

Pb-Free indicator, "G" or microdot "■", may or may not be present.

RECOMMENDED SOLDERING FOOTPRINT*

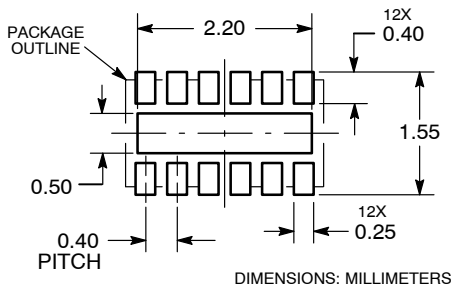

*For additional information on our Pb-Free strategy and soldering details, please download the ON Semiconductor Soldering and Mounting Techniques Reference Manual, SOLDERRM/D.

DOCUMENT NUMBER:	98AON47061E	Electronic versions are uncontrolled except when accessed directly from the Document Repository. Printed versions are uncontrolled except when stamped "CONTROLLED COPY" in red.
DESCRIPTION:	UDFN12, 2.5X1.35, 0.4P	PAGE 1 OF 1

ON Semiconductor and ON are trademarks of Semiconductor Components Industries, LLC dba ON Semiconductor or its subsidiaries in the United States and/or other countries. ON Semiconductor reserves the right to make changes without further notice to any products herein. ON Semiconductor makes no warranty, representation or guarantee regarding the suitability of its products for any particular purpose, nor does ON Semiconductor assume any liability arising out of the application or use of any product or circuit, and specifically disclaims any and all liability, including without limitation special, consequential or incidental damages. ON Semiconductor does not convey any license under its patent rights nor the rights of others.

MECHANICAL CASE OUTLINE

PACKAGE DIMENSIONS

ON Semiconductor®

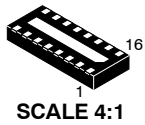

UDFN16, 3.3x1.35, 0.4P
CASE 517BE-01
ISSUE O

DATE 18 NOV 2009

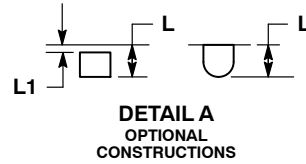
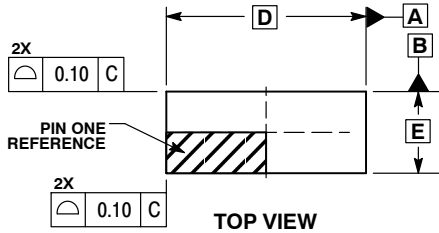

- NOTES:
1. DIMENSIONING AND TOLERANCING PER ASME Y14.5M, 1994.
 2. CONTROLLING DIMENSION: MILLIMETERS.
 3. DIMENSION b APPLIES TO PLATED TERMINAL AND IS MEASURED BETWEEN 0.15 AND 0.25 mm FROM THE TERMINAL TIP.
 4. COPLANARITY APPLIES TO THE EXPOSED PAD AS WELL AS THE TERMINALS.

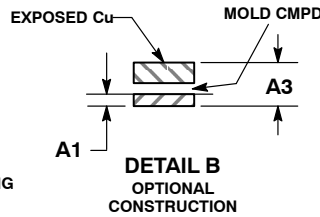
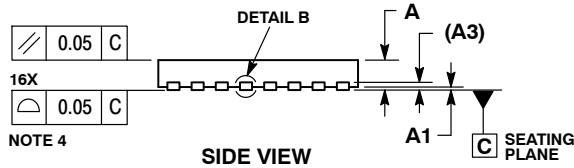

MILLIMETERS		
DIM	MIN	MAX
A	0.45	0.55
A1	0.00	0.05
A3	0.13	REF
b	0.15	0.25
D	3.30	BSC
D2	2.70	2.90
E	1.35	BSC
E2	0.30	0.50
e	0.40	BSC
K	0.15	---
L	0.20	0.30
L1	---	0.05

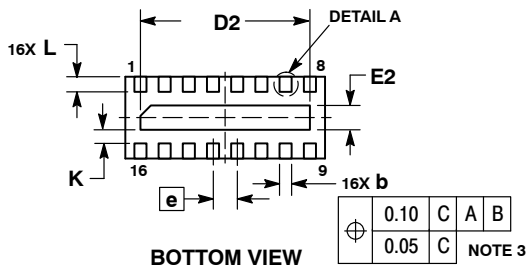

GENERIC MARKING DIAGRAM*

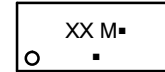

1

- XX = Specific Device Code
- M = Month Code
- = Pb-Free Package

(Note: Microdot may be in either location)

*This information is generic. Please refer to device data sheet for actual part marking.

Pb-Free indicator, "G" or microdot "▪", may or may not be present.

RECOMMENDED SOLDERING FOOTPRINT*

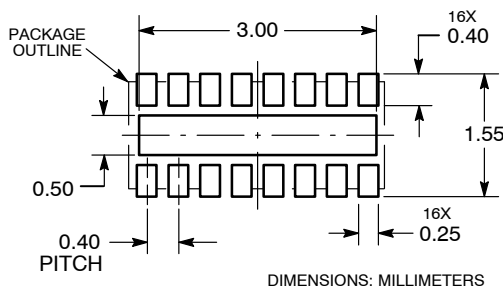

*For additional information on our Pb-Free strategy and soldering details, please download the ON Semiconductor Soldering and Mounting Techniques Reference Manual, SOLDERRM/D.

DOCUMENT NUMBER:	98AON47062E	Electronic versions are uncontrolled except when accessed directly from the Document Repository. Printed versions are uncontrolled except when stamped "CONTROLLED COPY" in red.
DESCRIPTION:	UDFN16, 3.3X1.35, 0.4P	PAGE 1 OF 1

ON Semiconductor and are trademarks of Semiconductor Components Industries, LLC dba ON Semiconductor or its subsidiaries in the United States and/or other countries. ON Semiconductor reserves the right to make changes without further notice to any products herein. ON Semiconductor makes no warranty, representation or guarantee regarding the suitability of its products for any particular purpose, nor does ON Semiconductor assume any liability arising out of the application or use of any product or circuit, and specifically disclaims any and all liability, including without limitation special, consequential or incidental damages. ON Semiconductor does not convey any license under its patent rights nor the rights of others.

ON Semiconductor and  are trademarks of Semiconductor Components Industries, LLC dba ON Semiconductor or its subsidiaries in the United States and/or other countries. ON Semiconductor owns the rights to a number of patents, trademarks, copyrights, trade secrets, and other intellectual property. A listing of ON Semiconductor's product/patent coverage may be accessed at www.onsemi.com/site/pdf/Patent-Marking.pdf. ON Semiconductor reserves the right to make changes without further notice to any products herein. ON Semiconductor makes no warranty, representation or guarantee regarding the suitability of its products for any particular purpose, nor does ON Semiconductor assume any liability arising out of the application or use of any product or circuit, and specifically disclaims any and all liability, including without limitation special, consequential or incidental damages. Buyer is responsible for its products and applications using ON Semiconductor products, including compliance with all laws, regulations and safety requirements or standards, regardless of any support or applications information provided by ON Semiconductor. "Typical" parameters which may be provided in ON Semiconductor data sheets and/or specifications can and do vary in different applications and actual performance may vary over time. All operating parameters, including "Typicals" must be validated for each customer application by customer's technical experts. ON Semiconductor does not convey any license under its patent rights nor the rights of others. ON Semiconductor products are not designed, intended, or authorized for use as a critical component in life support systems or any FDA Class 3 medical devices or medical devices with a same or similar classification in a foreign jurisdiction or any devices intended for implantation in the human body. Should Buyer purchase or use ON Semiconductor products for any such unintended or unauthorized application, Buyer shall indemnify and hold ON Semiconductor and its officers, employees, subsidiaries, affiliates, and distributors harmless against all claims, costs, damages, and expenses, and reasonable attorney fees arising out of, directly or indirectly, any claim of personal injury or death associated with such unintended or unauthorized use, even if such claim alleges that ON Semiconductor was negligent regarding the design or manufacture of the part. ON Semiconductor is an Equal Opportunity/Affirmative Action Employer. This literature is subject to all applicable copyright laws and is not for resale in any manner.

PUBLICATION ORDERING INFORMATION

LITERATURE FULFILLMENT:

Email Requests to: orderlit@onsemi.com

ON Semiconductor Website: www.onsemi.com

TECHNICAL SUPPORT

North American Technical Support:
Voice Mail: 1 800-282-9855 Toll Free USA/Canada
Phone: 011 421 33 790 2910

Europe, Middle East and Africa Technical Support:

Phone: 00421 33 790 2910

For additional information, please contact your local Sales Representative