

MUN2134, MMUN2134L, MUN5134, DTA124XE, DTA124XM3, NSBA124XF3

Digital Transistors (BRT) R1 = 22 kΩ, R2 = 47 kΩ

PNP Transistors with Monolithic Bias Resistor Network

This series of digital transistors is designed to replace a single device and its external resistor bias network. The Bias Resistor Transistor (BRT) contains a single transistor with a monolithic bias network consisting of two resistors; a series base resistor and a base-emitter resistor. The BRT eliminates these individual components by integrating them into a single device. The use of a BRT can reduce both system cost and board space.

Features

- Simplifies Circuit Design
- Reduces Board Space
- Reduces Component Count
- S and NSV Prefix for Automotive and Other Applications Requiring Unique Site and Control Change Requirements; AEC-Q101 Qualified and PPAP Capable
- These Devices are Pb-Free, Halogen Free/BFR Free and are RoHS Compliant

MAXIMUM RATINGS (T_A = 25°C)

Rating	Symbol	Max	Unit
Collector-Base Voltage	V _{CBO}	50	Vdc
Collector-Emitter Voltage	V _{CEO}	50	Vdc
Collector Current - Continuous	I _C	100	mAdc
Input Forward Voltage	V _{IN(fwd)}	40	Vdc
Input Reverse Voltage	V _{IN(rev)}	7	Vdc

Stresses exceeding those listed in the Maximum Ratings table may damage the device. If any of these limits are exceeded, device functionality should not be assumed, damage may occur and reliability may be affected.



ON Semiconductor®

www.onsemi.com

PIN CONNECTIONS

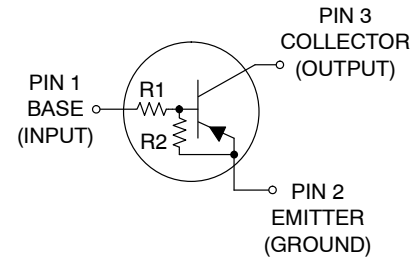

MARKING DIAGRAMS

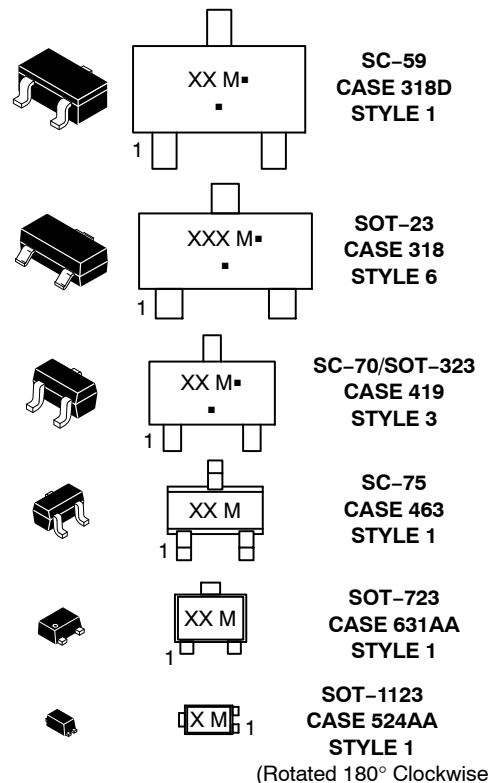

XXX = Specific Device Code
M = Date Code*
▪ = Pb-Free Package

(Note: Microdot may be in either location)

*Date Code orientation may vary depending upon manufacturing location.

ORDERING INFORMATION

See detailed ordering, marking, and shipping information in the package dimensions section on page 2 of this data sheet.

MUN2134, MMUN2134L, MUN5134, DTA124XE, DTA124XM3, NSBA124XF3

Table 1. ORDERING INFORMATION

Device	Part Marking	Package	Shipping†
MUN2134T1G	6L	SC-59 (Pb-Free)	3000 / Tape & Reel
MMUN2134LT1G, SMMUN2134LT1G*	A6L	SOT-23 (Pb-Free)	3000 / Tape & Reel
MUN5134T1G, NSVMUN5134T1G*	6L	SC-70/SOT-323 (Pb-Free)	3000 / Tape & Reel
DTA124XET1G	6L	SC-75 (Pb-Free)	3000 / Tape & Reel
DTA124XM3T5G	6L	SOT-723 (Pb-Free)	8000 / Tape & Reel
NSBA124XF3T5G	R (180°)**	SOT-1123 (Pb-Free)	8000 / Tape & Reel

†For information on tape and reel specifications, including part orientation and tape sizes, please refer to our Tape and Reel Packaging Specifications Brochure, BRD8011/D.

** (xx°) = Degree rotation in the clockwise direction.

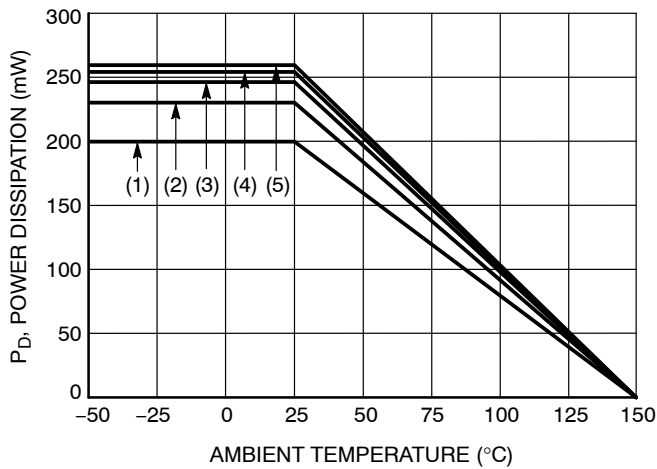

- (1) SC-75 and SC-70/SOT323; Minimum Pad
- (2) SC-59; Minimum Pad
- (3) SOT-23; Minimum Pad
- (4) SOT-1123; 100 mm², 1 oz. copper trace
- (5) SOT-723; Minimum Pad

Figure 1. Derating Curve

MUN2134, MMUN2134L, MUN5134, DTA124XE, DTA124XM3, NSBA124XF3

Table 2. THERMAL CHARACTERISTICS

Characteristic	Symbol	Max	Unit
THERMAL CHARACTERISTICS (SC-59) (MUN2134)			
Total Device Dissipation $T_A = 25^\circ\text{C}$ Derate above 25°C	(Note 1) (Note 2) (Note 1) (Note 2)	P_D 230 338 1.8 2.7	mW mW/ $^\circ\text{C}$
Thermal Resistance, Junction to Ambient	(Note 1) (Note 2)	$R_{\theta JA}$ 540 370	$^\circ\text{C/W}$
Thermal Resistance, Junction to Lead	(Note 1) (Note 2)	$R_{\theta JL}$ 264 287	$^\circ\text{C/W}$
Junction and Storage Temperature Range	T_J, T_{stg}	-55 to +150	$^\circ\text{C}$
THERMAL CHARACTERISTICS (SOT-23) (MMUN2134L)			
Total Device Dissipation $T_A = 25^\circ\text{C}$ Derate above 25°C	(Note 1) (Note 2) (Note 1) (Note 2)	P_D 246 400 2.0 3.2	mW mW/ $^\circ\text{C}$
Thermal Resistance, Junction to Ambient	(Note 1) (Note 2)	$R_{\theta JA}$ 508 311	$^\circ\text{C/W}$
Thermal Resistance, Junction to Lead	(Note 1) (Note 2)	$R_{\theta JL}$ 174 208	$^\circ\text{C/W}$
Junction and Storage Temperature Range	T_J, T_{stg}	-55 to +150	$^\circ\text{C}$
THERMAL CHARACTERISTICS (SC-70/SOT-323) (MUN5134)			
Total Device Dissipation $T_A = 25^\circ\text{C}$ Derate above 25°C	(Note 1) (Note 2) (Note 1) (Note 2)	P_D 202 310 1.6 2.5	mW mW/ $^\circ\text{C}$
Thermal Resistance, Junction to Ambient	(Note 1) (Note 2)	$R_{\theta JA}$ 618 403	$^\circ\text{C/W}$
Thermal Resistance, Junction to Lead	(Note 1) (Note 2)	$R_{\theta JL}$ 280 332	$^\circ\text{C/W}$
Junction and Storage Temperature Range	T_J, T_{stg}	-55 to +150	$^\circ\text{C}$
THERMAL CHARACTERISTICS (SC-75) (DTA124XE)			
Total Device Dissipation $T_A = 25^\circ\text{C}$ Derate above 25°C	(Note 1) (Note 2) (Note 1) (Note 2)	P_D 200 300 1.6 2.4	mW mW/ $^\circ\text{C}$
Thermal Resistance, Junction to Ambient	(Note 1) (Note 2)	$R_{\theta JA}$ 600 400	$^\circ\text{C/W}$
Junction and Storage Temperature Range	T_J, T_{stg}	-55 to +150	$^\circ\text{C}$
THERMAL CHARACTERISTICS (SOT-723) (DTA124XM3)			
Total Device Dissipation $T_A = 25^\circ\text{C}$ Derate above 25°C	(Note 1) (Note 2) (Note 1) (Note 2)	P_D 260 600 2.0 4.8	mW mW/ $^\circ\text{C}$
Thermal Resistance, Junction to Ambient	(Note 1) (Note 2)	$R_{\theta JA}$ 480 205	$^\circ\text{C/W}$
Junction and Storage Temperature Range	T_J, T_{stg}	-55 to +150	$^\circ\text{C}$

- FR-4 @ Minimum Pad.
- FR-4 @ 1.0 x 1.0 Inch Pad.
- FR-4 @ 100 mm², 1 oz. copper traces, still air.
- FR-4 @ 500 mm², 1 oz. copper traces, still air.

MUN2134, MMUN2134L, MUN5134, DTA124XE, DTA124XM3, NSBA124XF3

Table 2. THERMAL CHARACTERISTICS

Characteristic	Symbol	Max	Unit
THERMAL CHARACTERISTICS (SOT-1123) (NSBA124XF3)			
Total Device Dissipation $T_A = 25^\circ\text{C}$	P_D	254 297	mW
Derate above 25°C		2.0 2.4	mW/ $^\circ\text{C}$
Thermal Resistance, Junction to Ambient	$R_{\theta JA}$	493 421	$^\circ\text{C}/\text{W}$
Thermal Resistance, Junction to Lead	$R_{\theta JL}$	193	$^\circ\text{C}/\text{W}$
Junction and Storage Temperature Range	T_J, T_{stg}	-55 to +150	$^\circ\text{C}$

- FR-4 @ Minimum Pad.
- FR-4 @ 1.0 x 1.0 Inch Pad.
- FR-4 @ 100 mm², 1 oz. copper traces, still air.
- FR-4 @ 500 mm², 1 oz. copper traces, still air.

Table 3. ELECTRICAL CHARACTERISTICS ($T_A = 25^\circ\text{C}$, unless otherwise noted)

Characteristic	Symbol	Min	Typ	Max	Unit
OFF CHARACTERISTICS					
Collector-Base Cutoff Current ($V_{CB} = 50\text{ V}, I_E = 0$)	I_{CBO}	-	-	100	nAdc
Collector-Emitter Cutoff Current ($V_{CE} = 50\text{ V}, I_B = 0$)	I_{CEO}	-	-	500	nAdc
Emitter-Base Cutoff Current ($V_{EB} = 6.0\text{ V}, I_C = 0$)	I_{EBO}	-	-	0.13	mAdc
Collector-Base Breakdown Voltage ($I_C = 10\ \mu\text{A}, I_E = 0$)	$V_{(BR)CBO}$	50	-	-	Vdc
Collector-Emitter Breakdown Voltage (Note 5) ($I_C = 2.0\text{ mA}, I_B = 0$)	$V_{(BR)CEO}$	50	-	-	Vdc
ON CHARACTERISTICS					
DC Current Gain (Note 5) ($I_C = 5.0\text{ mA}, V_{CE} = 10\text{ V}$)	h_{FE}	80	130	-	
Collector - Emitter Saturation Voltage (Note 5) ($I_C = 10\text{ mA}, I_B = 1.0\text{ mA}$)	$V_{CE(sat)}$	-	-	0.25	Vdc
Input Voltage (off) ($V_{CE} = 5.0\text{ V}, I_C = 100\ \mu\text{A}$)	$V_{i(off)}$	-	0.9	0.5	Vdc
Input Voltage (on) ($V_{CE} = 0.3\text{ V}, I_C = 2.0\text{ mA}$)	$V_{i(on)}$	2.0	1.2	-	Vdc
Output Voltage (on) ($V_{CC} = 5.0\text{ V}, V_B = 2.5\text{ V}, R_L = 1.0\text{ k}\Omega$)	V_{OL}	-	-	0.2	Vdc
Output Voltage (off) ($V_{CC} = 5.0\text{ V}, V_B = 0.5\text{ V}, R_L = 1.0\text{ k}\Omega$)	V_{OH}	4.9	-	-	Vdc
Input Resistor	R_1	15.4	22	28.6	k Ω
Resistor Ratio	R_1/R_2	0.38	0.47	0.56	

Product parametric performance is indicated in the Electrical Characteristics for the listed test conditions, unless otherwise noted. Product performance may not be indicated by the Electrical Characteristics if operated under different conditions.

- Pulsed Condition: Pulse Width = 300 msec, Duty Cycle \leq 2%.

TYPICAL CHARACTERISTICS
MUN2134, MMUN2134L, MUN5134, DTA124XE, DTA124XM3

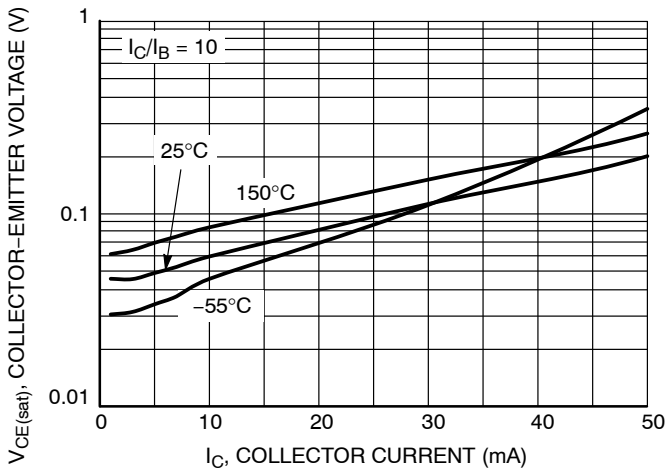

Figure 2. $V_{CE(sat)}$ vs. I_C

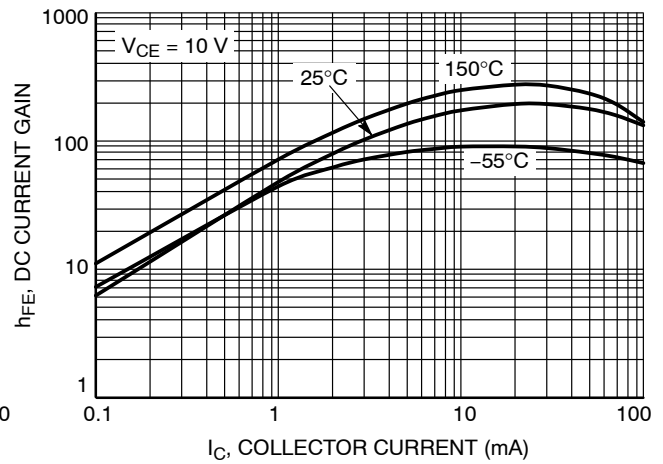

Figure 3. DC Current Gain

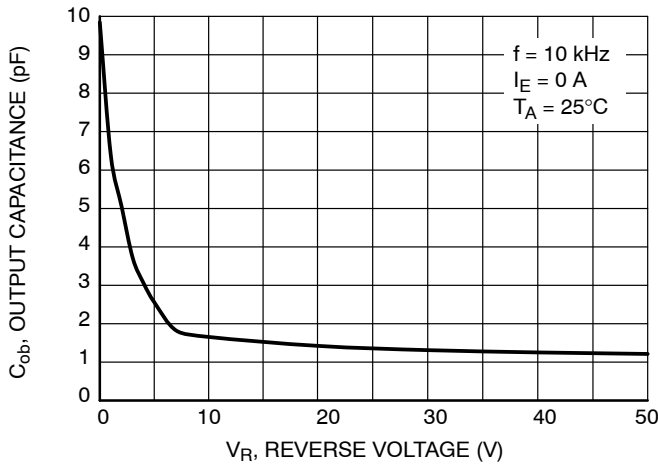

Figure 4. Output Capacitance

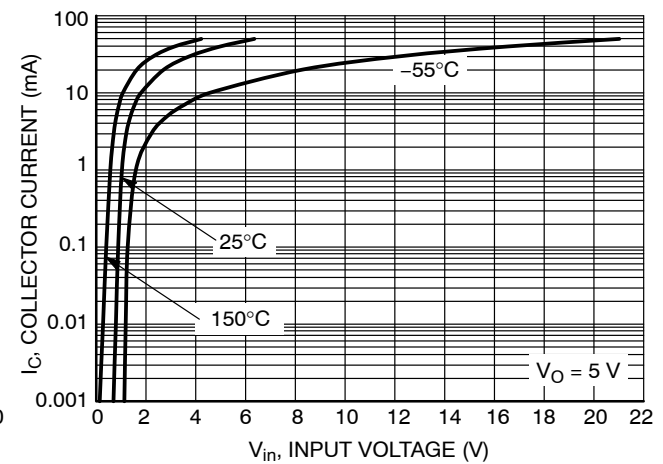

Figure 5. Output Current vs. Input Voltage

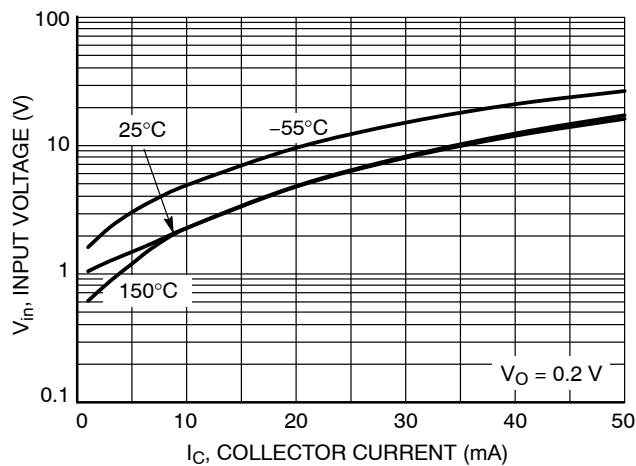

Figure 6. Input Voltage vs. Output Current

MECHANICAL CASE OUTLINE

PACKAGE DIMENSIONS

ON Semiconductor®



SOT-23 (TO-236) CASE 318-08 ISSUE AS

DATE 30 JAN 2018

SCALE 4:1



NOTES:

1. DIMENSIONING AND TOLERANCING PER ASME Y14.5M, 1994.
2. CONTROLLING DIMENSION: MILLIMETERS.
3. MAXIMUM LEAD THICKNESS INCLUDES LEAD FINISH. MINIMUM LEAD THICKNESS IS THE MINIMUM THICKNESS OF THE BASE MATERIAL.
4. DIMENSIONS D AND E DO NOT INCLUDE MOLD FLASH, PROTRUSIONS, OR GATE BURRS.

DIM	MILLIMETERS			INCHES		
	MIN	NOM	MAX	MIN	NOM	MAX
A	0.89	1.00	1.11	0.035	0.039	0.044
A1	0.01	0.06	0.10	0.000	0.002	0.004
b	0.37	0.44	0.50	0.015	0.017	0.020
c	0.08	0.14	0.20	0.003	0.006	0.008
D	2.80	2.90	3.04	0.110	0.114	0.120
E	1.20	1.30	1.40	0.047	0.051	0.055
e	1.78	1.90	2.04	0.070	0.075	0.080
L	0.30	0.43	0.55	0.012	0.017	0.022
L1	0.35	0.54	0.69	0.014	0.021	0.027
HE	2.10	2.40	2.64	0.083	0.094	0.104
T	0°	---	10°	0°	---	10°

RECOMMENDED SOLDERING FOOTPRINT



GENERIC MARKING DIAGRAM*



XXX = Specific Device Code
M = Date Code
▪ = Pb-Free Package

*This information is generic. Please refer to device data sheet for actual part marking. Pb-Free indicator, "G" or microdot "▪", may or may not be present.

STYLE 1 THRU 5:
CANCELLED

STYLE 6:
PIN 1. BASE
2. EMITTER
3. COLLECTOR

STYLE 7:
PIN 1. EMITTER
2. BASE
3. COLLECTOR

STYLE 8:
PIN 1. ANODE
2. NO CONNECTION
3. CATHODE

STYLE 9:
PIN 1. ANODE
2. ANODE
3. CATHODE

STYLE 10:
PIN 1. DRAIN
2. SOURCE
3. GATE

STYLE 11:
PIN 1. ANODE
2. CATHODE
3. CATHODE-ANODE

STYLE 12:
PIN 1. CATHODE
2. CATHODE
3. ANODE

STYLE 13:
PIN 1. SOURCE
2. DRAIN
3. GATE

STYLE 14:
PIN 1. CATHODE
2. GATE
3. ANODE

STYLE 15:
PIN 1. GATE
2. CATHODE
3. ANODE

STYLE 16:
PIN 1. ANODE
2. CATHODE
3. CATHODE

STYLE 17:
PIN 1. NO CONNECTION
2. ANODE
3. CATHODE

STYLE 18:
PIN 1. NO CONNECTION
2. CATHODE
3. ANODE

STYLE 19:
PIN 1. CATHODE
2. ANODE
3. CATHODE-ANODE

STYLE 20:
PIN 1. CATHODE
2. ANODE
3. GATE

STYLE 21:
PIN 1. GATE
2. SOURCE
3. DRAIN

STYLE 22:
PIN 1. RETURN
2. OUTPUT
3. INPUT

STYLE 23:
PIN 1. ANODE
2. ANODE
3. CATHODE

STYLE 24:
PIN 1. GATE
2. DRAIN
3. SOURCE

STYLE 25:
PIN 1. ANODE
2. CATHODE
3. GATE

STYLE 26:
PIN 1. CATHODE
2. ANODE
3. NO CONNECTION

STYLE 27:
PIN 1. CATHODE
2. CATHODE
3. CATHODE

STYLE 28:
PIN 1. ANODE
2. ANODE
3. ANODE

DOCUMENT NUMBER:	98ASB42226B	Electronic versions are uncontrolled except when accessed directly from the Document Repository. Printed versions are uncontrolled except when stamped "CONTROLLED COPY" in red.
DESCRIPTION:	SOT-23 (TO-236)	PAGE 1 OF 1

ON Semiconductor and are trademarks of Semiconductor Components Industries, LLC dba ON Semiconductor or its subsidiaries in the United States and/or other countries. ON Semiconductor reserves the right to make changes without further notice to any products herein. ON Semiconductor makes no warranty, representation or guarantee regarding the suitability of its products for any particular purpose, nor does ON Semiconductor assume any liability arising out of the application or use of any product or circuit, and specifically disclaims any and all liability, including without limitation special, consequential or incidental damages. ON Semiconductor does not convey any license under its patent rights nor the rights of others.

MECHANICAL CASE OUTLINE

PACKAGE DIMENSIONS

ON Semiconductor®



SC-59
CASE 318D-04
ISSUE H

DATE 28 JUN 2012

SCALE 2:1



SOLDERING FOOTPRINT*



*For additional information on our Pb-Free strategy and soldering details, please download the ON Semiconductor Soldering and Mounting Techniques Reference Manual, SOLDERRM/D.

NOTES:
1. DIMENSIONING AND TOLERANCING PER ANSI Y14.5M, 1982.
2. CONTROLLING DIMENSION: MILLIMETER.

DIM	MILLIMETERS			INCHES		
	MIN	NOM	MAX	MIN	NOM	MAX
A	1.00	1.15	1.30	0.039	0.045	0.051
A1	0.01	0.06	0.10	0.001	0.002	0.004
b	0.35	0.43	0.50	0.014	0.017	0.020
c	0.09	0.14	0.18	0.003	0.005	0.007
D	2.70	2.90	3.10	0.106	0.114	0.122
E	1.30	1.50	1.70	0.051	0.059	0.067
e	1.70	1.90	2.10	0.067	0.075	0.083
L	0.20	0.40	0.60	0.008	0.016	0.024
HE	2.50	2.80	3.00	0.099	0.110	0.118

GENERIC MARKING DIAGRAM



XXX = Specific Device Code
M = Date Code
▪ = Pb-Free Package*

(*Note: Microdot may be in either location)

*This information is generic. Please refer to device data sheet for actual part marking. Pb-Free indicator, "G" or microdot "▪", may or may not be present.

STYLE 1: PIN 1. BASE
2. EMITTER
3. COLLECTOR

STYLE 2: PIN 1. ANODE
2. N.C.
3. CATHODE

STYLE 3: PIN 1. ANODE
2. ANODE
3. CATHODE

STYLE 4: PIN 1. CATHODE
2. N.C.
3. ANODE

STYLE 5: PIN 1. CATHODE
2. CATHODE
3. ANODE

STYLE 6: PIN 1. ANODE
2. CATHODE
3. ANODE/CATHODE

DOCUMENT NUMBER:	98ASB42664B	Electronic versions are uncontrolled except when accessed directly from the Document Repository. Printed versions are uncontrolled except when stamped "CONTROLLED COPY" in red.
DESCRIPTION:	SC-59	PAGE 1 OF 1

ON Semiconductor and ON are trademarks of Semiconductor Components Industries, LLC dba ON Semiconductor or its subsidiaries in the United States and/or other countries. ON Semiconductor reserves the right to make changes without further notice to any products herein. ON Semiconductor makes no warranty, representation or guarantee regarding the suitability of its products for any particular purpose, nor does ON Semiconductor assume any liability arising out of the application or use of any product or circuit, and specifically disclaims any and all liability, including without limitation special, consequential or incidental damages. ON Semiconductor does not convey any license under its patent rights nor the rights of others.

MECHANICAL CASE OUTLINE

PACKAGE DIMENSIONS

ON Semiconductor®

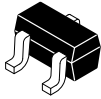

SCALE 4:1

SC-70 (SOT-323)
CASE 419-04
ISSUE N

DATE 11 NOV 2008

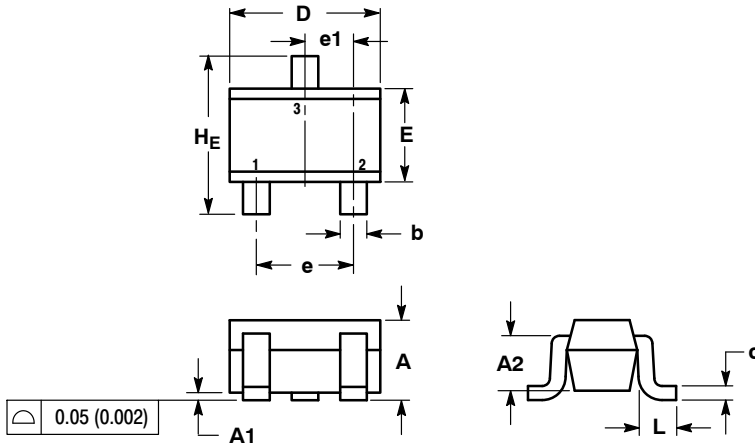

NOTES:

1. DIMENSIONING AND TOLERANCING PER ANSI Y14.5M, 1982.
2. CONTROLLING DIMENSION: INCH.

DIM	MILLIMETERS			INCHES		
	MIN	NOM	MAX	MIN	NOM	MAX
A	0.80	0.90	1.00	0.032	0.035	0.040
A1	0.00	0.05	0.10	0.000	0.002	0.004
A2	0.70 REF			0.028 REF		
b	0.30	0.35	0.40	0.012	0.014	0.016
c	0.10	0.18	0.25	0.004	0.007	0.010
D	1.80	2.10	2.20	0.071	0.083	0.087
E	1.15	1.24	1.35	0.045	0.049	0.053
e	1.20	1.30	1.40	0.047	0.051	0.055
e1	0.65 BSC			0.026 BSC		
L	0.20	0.38	0.56	0.008	0.015	0.022
HE	2.00	2.10	2.40	0.079	0.083	0.095

GENERIC MARKING DIAGRAM

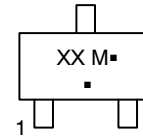

- XX = Specific Device Code
- M = Date Code
- = Pb-Free Package

*This information is generic. Please refer to device data sheet for actual part marking. Pb-Free indicator, "G" or microdot "▪", may or may not be present.

SOLDERING FOOTPRINT*

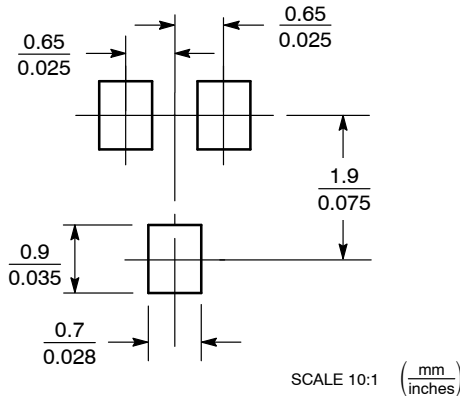

*For additional information on our Pb-Free strategy and soldering details, please download the ON Semiconductor Soldering and Mounting Techniques Reference Manual, SOLDERRM/D.

STYLE 1: CANCELLED	STYLE 2: PIN 1. ANODE 2. N.C. 3. CATHODE	STYLE 3: PIN 1. BASE 2. EMITTER 3. COLLECTOR	STYLE 4: PIN 1. CATHODE 2. CATHODE 3. ANODE	STYLE 5: PIN 1. ANODE 2. ANODE 3. CATHODE	
STYLE 6: PIN 1. EMITTER 2. BASE 3. COLLECTOR	STYLE 7: PIN 1. BASE 2. EMITTER 3. COLLECTOR	STYLE 8: PIN 1. GATE 2. SOURCE 3. DRAIN	STYLE 9: PIN 1. ANODE 2. CATHODE 3. CATHODE-ANODE	STYLE 10: PIN 1. CATHODE 2. ANODE 3. ANODE-CATHODE	STYLE 11: PIN 1. CATHODE 2. CATHODE 3. CATHODE

DOCUMENT NUMBER:	98ASB42819B	Electronic versions are uncontrolled except when accessed directly from the Document Repository. Printed versions are uncontrolled except when stamped "CONTROLLED COPY" in red.
DESCRIPTION:	SC-70 (SOT-323)	PAGE 1 OF 1

ON Semiconductor and ON are trademarks of Semiconductor Components Industries, LLC dba ON Semiconductor or its subsidiaries in the United States and/or other countries. ON Semiconductor reserves the right to make changes without further notice to any products herein. ON Semiconductor makes no warranty, representation or guarantee regarding the suitability of its products for any particular purpose, nor does ON Semiconductor assume any liability arising out of the application or use of any product or circuit, and specifically disclaims any and all liability, including without limitation special, consequential or incidental damages. ON Semiconductor does not convey any license under its patent rights nor the rights of others.

MECHANICAL CASE OUTLINE

PACKAGE DIMENSIONS

ON Semiconductor®



SC-75/SOT-416
CASE 463-01
ISSUE G

DATE 07 AUG 2015

SCALE 4:1

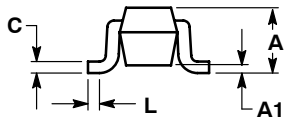

STYLE 1:
PIN 1. BASE
2. EMITTER
3. COLLECTOR

STYLE 2:
PIN 1. ANODE
2. N/C
3. CATHODE

STYLE 3:
PIN 1. ANODE
2. ANODE
3. CATHODE

STYLE 4:
PIN 1. CATHODE
2. CATHODE
3. ANODE

STYLE 5:
PIN 1. GATE
2. SOURCE
3. DRAIN

NOTES:

1. DIMENSIONING AND TOLERANCING PER ANSI Y14.5M, 1982.
2. CONTROLLING DIMENSION: MILLIMETER.

DIM	MILLIMETERS			INCHES		
	MIN	NOM	MAX	MIN	NOM	MAX
A	0.70	0.80	0.90	0.027	0.031	0.035
A1	0.00	0.05	0.10	0.000	0.002	0.004
b	0.15	0.20	0.30	0.006	0.008	0.012
C	0.10	0.15	0.25	0.004	0.006	0.010
D	1.55	1.60	1.65	0.061	0.063	0.065
E	0.70	0.80	0.90	0.027	0.031	0.035
e	1.00 BSC			0.04 BSC		
L	0.10	0.15	0.20	0.004	0.006	0.008
HE	1.50	1.60	1.70	0.060	0.063	0.067

GENERIC MARKING DIAGRAM*

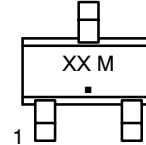

- XX = Specific Device Code
- M = Date Code
- = Pb-Free Package

*This information is generic. Please refer to device data sheet for actual part marking. Pb-Free indicator, "G" or microdot "■", may or may not be present.

SOLDERING FOOTPRINT*

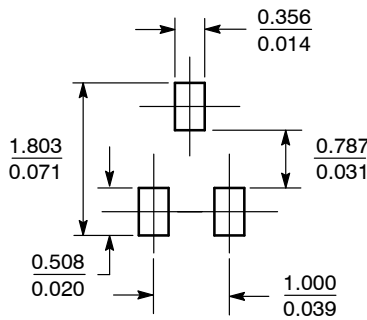

SCALE 10:1 (mm/inches)

*For additional information on our Pb-Free strategy and soldering details, please download the ON Semiconductor Soldering and Mounting Techniques Reference Manual, SOLDERRM/D.

DOCUMENT NUMBER:	98ASB15184C	Electronic versions are uncontrolled except when accessed directly from the Document Repository. Printed versions are uncontrolled except when stamped "CONTROLLED COPY" in red.
DESCRIPTION:	SC-75/SOT-416	PAGE 1 OF 1

ON Semiconductor and are trademarks of Semiconductor Components Industries, LLC dba ON Semiconductor or its subsidiaries in the United States and/or other countries. ON Semiconductor reserves the right to make changes without further notice to any products herein. ON Semiconductor makes no warranty, representation or guarantee regarding the suitability of its products for any particular purpose, nor does ON Semiconductor assume any liability arising out of the application or use of any product or circuit, and specifically disclaims any and all liability, including without limitation special, consequential or incidental damages. ON Semiconductor does not convey any license under its patent rights nor the rights of others.

MECHANICAL CASE OUTLINE

PACKAGE DIMENSIONS

ON Semiconductor®



SCALE 8:1

SOT-1123
CASE 524AA
ISSUE C

DATE 29 NOV 2011

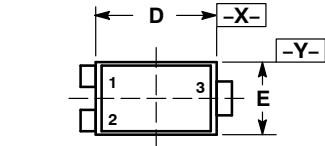

TOP VIEW

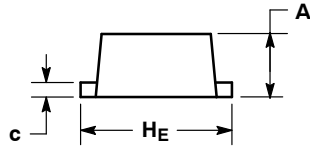

SIDE VIEW

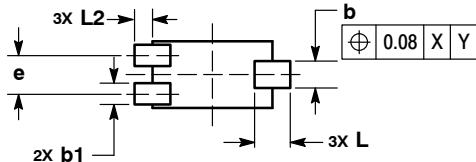

BOTTOM VIEW

SOLDERING FOOTPRINT*

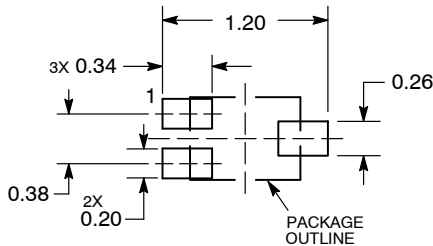

DIMENSIONS: MILLIMETERS

NOTES:

1. DIMENSIONING AND TOLERANCING PER ASME Y14.5M, 1994.
2. CONTROLLING DIMENSION: MILLIMETERS.
3. MAXIMUM LEAD THICKNESS INCLUDES LEAD FINISH. MINIMUM LEAD THICKNESS IS THE MINIMUM THICKNESS OF BASE MATERIAL.
4. DIMENSIONS D AND E DO NOT INCLUDE MOLD FLASH, PROTRUSIONS, OR GATE BURRS.

DIM	MILLIMETERS	
	MIN	MAX
A	0.34	0.40
b	0.15	0.28
b1	0.10	0.20
c	0.07	0.17
D	0.75	0.85
E	0.55	0.65
e	0.35	0.40
HE	0.95	1.05
L	0.185	REF
L2	0.05	0.15

GENERIC MARKING DIAGRAM*

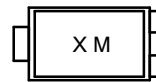

X = Specific Device Code
M = Date Code

*This information is generic. Please refer to device data sheet for actual part marking.
Pb-Free indicator, "G" or microdot "•", may or may not be present.

*For additional information on our Pb-Free strategy and soldering details, please download the ON Semiconductor Soldering and Mounting Techniques Reference Manual, SOLDERRM/D.

- | | | | | |
|---|--|--|--|--|
| STYLE 1:
PIN 1. BASE
2. EMITTER
3. COLLECTOR | STYLE 2:
PIN 1. ANODE
2. N/C
3. CATHODE | STYLE 3:
PIN 1. ANODE
2. ANODE
3. CATHODE | STYLE 4:
PIN 1. CATHODE
2. CATHODE
3. ANODE | STYLE 5:
PIN 1. GATE
2. SOURCE
3. DRAIN |
|---|--|--|--|--|

DOCUMENT NUMBER:	98AON23134D	Electronic versions are uncontrolled except when accessed directly from the Document Repository. Printed versions are uncontrolled except when stamped "CONTROLLED COPY" in red.
DESCRIPTION:	SOT-1123, 3-LEAD, 1.0X0.6X0.37, 0.35P	PAGE 1 OF 1

ON Semiconductor and are trademarks of Semiconductor Components Industries, LLC dba ON Semiconductor or its subsidiaries in the United States and/or other countries. ON Semiconductor reserves the right to make changes without further notice to any products herein. ON Semiconductor makes no warranty, representation or guarantee regarding the suitability of its products for any particular purpose, nor does ON Semiconductor assume any liability arising out of the application or use of any product or circuit, and specifically disclaims any and all liability, including without limitation special, consequential or incidental damages. ON Semiconductor does not convey any license under its patent rights nor the rights of others.

MECHANICAL CASE OUTLINE

PACKAGE DIMENSIONS

ON Semiconductor®



SCALE 4:1

SOT-723
CASE 631AA-01
ISSUE D

DATE 10 AUG 2009

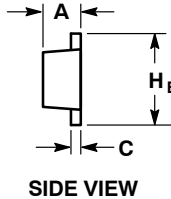

NOTES:

1. DIMENSIONING AND TOLERANCING PER ASME Y14.5M, 1994.
2. CONTROLLING DIMENSION: MILLIMETERS.
3. MAXIMUM LEAD THICKNESS INCLUDES LEAD FINISH. MINIMUM LEAD THICKNESS IS THE MINIMUM THICKNESS OF BASE MATERIAL.
4. DIMENSIONS D AND E DO NOT INCLUDE MOLD FLASH, PROTRUSIONS OR GATE BURRS.

MILLIMETERS			
DIM	MIN	NOM	MAX
A	0.45	0.50	0.55
b	0.15	0.21	0.27
b1	0.25	0.31	0.37
C	0.07	0.12	0.17
D	1.15	1.20	1.25
E	0.75	0.80	0.85
e	0.40 BSC		
H E	1.15	1.20	1.25
L	0.29 REF		
L2	0.15	0.20	0.25

GENERIC MARKING DIAGRAM*

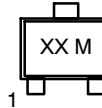

XX = Specific Device Code
M = Date Code

- | | | | | |
|---|--|--|--|--|
| STYLE 1:
PIN 1. BASE
2. EMITTER
3. COLLECTOR | STYLE 2:
PIN 1. ANODE
2. N/C
3. CATHODE | STYLE 3:
PIN 1. ANODE
2. ANODE
3. CATHODE | STYLE 4:
PIN 1. CATHODE
2. CATHODE
3. ANODE | STYLE 5:
PIN 1. GATE
2. SOURCE
3. DRAIN |
|---|--|--|--|--|

RECOMMENDED SOLDERING FOOTPRINT*



*This information is generic. Please refer to device data sheet for actual part marking. Pb-Free indicator, "G", may or not be present.

*For additional information on our Pb-Free strategy and soldering details, please download the ON Semiconductor Soldering and Mounting Techniques Reference Manual, SOLDERRM/D.

DOCUMENT NUMBER:	98AON12989D	Electronic versions are uncontrolled except when accessed directly from the Document Repository. Printed versions are uncontrolled except when stamped "CONTROLLED COPY" in red.
DESCRIPTION:	SOT-723	PAGE 1 OF 1

ON Semiconductor and are trademarks of Semiconductor Components Industries, LLC dba ON Semiconductor or its subsidiaries in the United States and/or other countries. ON Semiconductor reserves the right to make changes without further notice to any products herein. ON Semiconductor makes no warranty, representation or guarantee regarding the suitability of its products for any particular purpose, nor does ON Semiconductor assume any liability arising out of the application or use of any product or circuit, and specifically disclaims any and all liability, including without limitation special, consequential or incidental damages. ON Semiconductor does not convey any license under its patent rights nor the rights of others.

onsemi, **Onsemi**, and other names, marks, and brands are registered and/or common law trademarks of Semiconductor Components Industries, LLC dba "**onsemi**" or its affiliates and/or subsidiaries in the United States and/or other countries. **onsemi** owns the rights to a number of patents, trademarks, copyrights, trade secrets, and other intellectual property. A listing of **onsemi**'s product/patent coverage may be accessed at www.onsemi.com/site/pdf/Patent-Marking.pdf. **onsemi** reserves the right to make changes at any time to any products or information herein, without notice. The information herein is provided "as-is" and **onsemi** makes no warranty, representation or guarantee regarding the accuracy of the information, product features, availability, functionality, or suitability of its products for any particular purpose, nor does **onsemi** assume any liability arising out of the application or use of any product or circuit, and specifically disclaims any and all liability, including without limitation special, consequential or incidental damages. Buyer is responsible for its products and applications using **onsemi** products, including compliance with all laws, regulations and safety requirements or standards, regardless of any support or applications information provided by **onsemi**. "Typical" parameters which may be provided in **onsemi** data sheets and/or specifications can and do vary in different applications and actual performance may vary over time. All operating parameters, including "Typicals" must be validated for each customer application by customer's technical experts. **onsemi** does not convey any license under any of its intellectual property rights nor the rights of others. **onsemi** products are not designed, intended, or authorized for use as a critical component in life support systems or any FDA Class 3 medical devices or medical devices with a same or similar classification in a foreign jurisdiction or any devices intended for implantation in the human body. Should Buyer purchase or use **onsemi** products for any such unintended or unauthorized application, Buyer shall indemnify and hold **onsemi** and its officers, employees, subsidiaries, affiliates, and distributors harmless against all claims, costs, damages, and expenses, and reasonable attorney fees arising out of, directly or indirectly, any claim of personal injury or death associated with such unintended or unauthorized use, even if such claim alleges that **onsemi** was negligent regarding the design or manufacture of the part. **onsemi** is an Equal Opportunity/Affirmative Action Employer. This literature is subject to all applicable copyright laws and is not for resale in any manner.

PUBLICATION ORDERING INFORMATION

LITERATURE FULFILLMENT:

Email Requests to: orderlit@onsemi.com

onsemi Website: www.onsemi.com

TECHNICAL SUPPORT

North American Technical Support:

Voice Mail: 1 800-282-9855 Toll Free USA/Canada

Phone: 011 421 33 790 2910

Europe, Middle East and Africa Technical Support:

Phone: 00421 33 790 2910

For additional information, please contact your local Sales Representative