

CAT4101

1 A Constant-Current LED Driver with PWM Dimming

Description

The CAT4101 is a constant-current sink driving a string of high-brightness LEDs up to 1 A with very low dropout of 0.5 V at full load. It requires no inductor, provides a low noise operation and minimizes the number of components. The LED current is set by an external resistor connected to the RSET pin. The LED pin is compatible with high voltage up to 25 V, allowing the driving of long strings of LEDs. The device ensures an accurate and regulated current in the LEDs independent of supply and LED forward voltage variation.

The PWM/EN input allows the device shutdown and the LED brightness adjustment by using an external pulse width modulation (PWM) signal.

The driver features a thermal shutdown protection that becomes active whenever the die temperature exceeds 150°C.

The device is available in a high-power, 5-lead TO-263 package offering excellent thermal dissipation characteristics.

Features

- Accurate 1 A Current Sink
- Up to 25 V Operation on LED Pin
- Low Dropout 500 mV at 1 A
- LED Current Set by External Resistor
- High Resolution PWM Dimming via EN/PWM
- “Zero” Current Shutdown Mode
- Thermal Shutdown Protection
- TO-263 (D²PAK) 5-lead Package
- This Device is Pb-Free, Halogen Free/BFR Free and is RoHS Compliant

Applications

- High Power LED up to 1 A
- Architectural and General Lighting
- Automotive Lighting

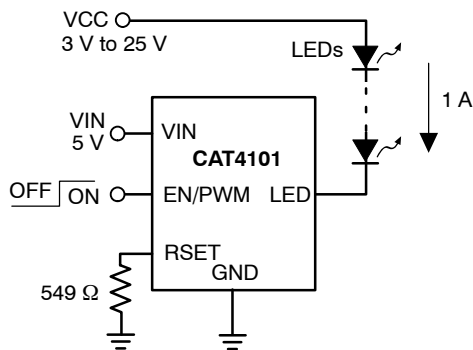
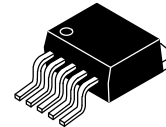

Figure 1. Typical Application Circuit



ON Semiconductor®

<http://onsemi.com>



D²PAK 5
(TO-263, 5 LEAD)
TV SUFFIX
CASE 418AH

PIN CONNECTIONS

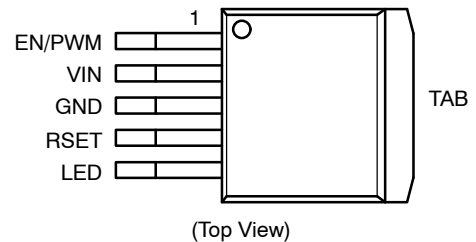

MARKING DIAGRAM

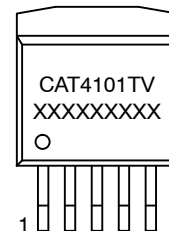

CAT4101TV = Specific Device Code
XXXXXXXXXX = Internal Traceability

ORDERING INFORMATION

Device	Package	Shipping†
CAT4101TV-T75	TO-263 (D ² PAK, 5 Lead) (Pb-Free)	750 / Tape & Reel

†For information on tape and reel specifications, including part orientation and tape sizes, please refer to our Tape and Reel Packaging Specification Brochure, BRD8011/D.

CAT4101

Table 1. ABSOLUTE MAXIMUM RATINGS

Parameter	Rating	Units
VIN, RSET, EN/PWM Voltages	6	V
LED Voltage	25	V
Storage Temperature Range	-65 to +150	°C
Junction Temperature Range	-40 to +150	°C
Lead Temperature	300	°C

Stresses exceeding Maximum Ratings may damage the device. Maximum Ratings are stress ratings only. Functional operation above the Recommended Operating Conditions is not implied. Extended exposure to stresses above the Recommended Operating Conditions may affect device reliability.

Table 2. RECOMMENDED OPERATING CONDITIONS

Parameter	Rating	Units
VIN Voltage	3.0 to 5.5	V
LED Pin Voltage device enabled, continuous operation device disabled or transient when enabled	Up to 6 Up to 25	V
Ambient Temperature Range	-40 to +85	°C
LED Pin Current	Up to 1	A

NOTE: Typical application circuit with external components is shown on page 1.

1. For additional temperature options, please contact your nearest ON Semiconductor Sales office.

Table 3. ELECTRICAL OPERATING CHARACTERISTICS (Min and Max values in **bold** are over recommended operating conditions unless specified otherwise. Typical values are at VIN = 5.0 V, TAMB = 25°C)

Symbol	Parameter	Conditions	Min	Typ	Max	Units
ILED-ACC	LED Current Accuracy	VLED = 1 V, RSET = 1.47 kΩ	315	350	385	mA
		VLED = 1 V, RSET = 750 Ω		700		
		VLED = 1 V, RSET = 549 Ω		1000		
VDOUT	Dropout Voltage	ILED = 1 A		500		mV
VRSET	RSET Pin Voltage		1.17	1.20	1.23	V
IQ	Quiescent Current	No LED, RSET = Floating		0.8		mA
		No LED, RSET = 549 Ω		8.0		
IQSHDN	Shutdown Current	VEN = 0 V			1	μA
REN/PWM VHI VLO	EN/PWM Pin		1.3	200		kΩ V V
	- Pull-down resistance					
	- Logic High Level					
	- Logic Low Level				0.4	
TSD	Thermal Shutdown			150		°C
THYS	Thermal Hysteresis			20		°C
ILED/IRSET	RSET to LED Current gain ratio	100 mA LED current		400		
VUVLO	Undervoltage lockout (UVLO) Threshold			2.0		V

CAT4101

Table 4. RECOMMENDED EN/PWM TIMING

(For $3.0\text{ V} \leq V_{IN} \leq 5.5\text{ V}$, over full ambient temperature range -40°C to $+85^{\circ}\text{C}$.)

Symbol	Name	Conditions	Min	Typ	Max	Units
T_{PS}	Turn-On time, EN/PWM rising to I_{LED} from Shutdown	$I_{LED} = 1\text{ A}$ $I_{LED} = 350\text{ mA}$		1.6 1.1		μs
T_{P1}	Turn-On time, EN/PWM rising to I_{LED}	$I_{LED} = 1\text{ A}$ $I_{LED} = 350\text{ mA}$		920 620		ns
T_{P2}	Turn-Off time, EN/PWM falling to I_{LED}	$I_{LED} = 1\text{ A}$ $I_{LED} = 350\text{ mA}$		440 310		ns
T_R	LED rise time	$I_{LED} = 1\text{ A}$ $I_{LED} = 350\text{ mA}$		840 390		ns
T_F	LED fall time	$I_{LED} = 1\text{ A}$ $I_{LED} = 350\text{ mA}$		470 350		ns
T_{LO}	EN/PWM low time		1			μs
T_{HI}	EN/PWM high time		5			μs
T_{PWRDWN}	EN/PWM low time to shutdown delay				8	ms

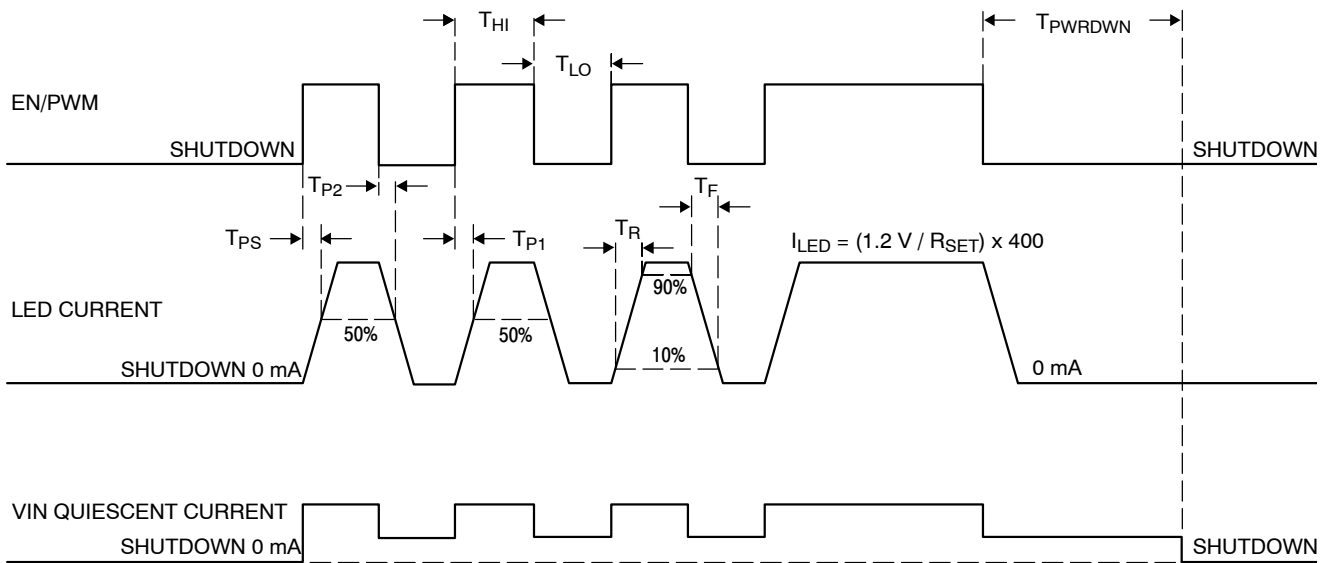

Figure 2. CAT4101 EN/PWM Timing

EN/PWM Operation

The EN/PWM pin has two primary functions. One function enables and disables the device. The other function turns the LED channel on and off for PWM dimming control. The device has a very fast turn-on time (from EN/PWM rising to LED on) and allows “instant on” when dimming LED using a PWM signal.

Accurate linear dimming is compatible with PWM frequencies from 100 Hz to 5 kHz for PWM duty cycle down to 1%. PWM frequencies up to 50 kHz can be supported for duty cycles greater than 10%.

When performing a combination of low frequencies and small duty cycles, the device may enter shutdown mode. This has no effect on the dimming accuracy, because the turn-on time T_{PS} is very short, in the range of 1 μs .

To ensure that PWM pulses are recognized, pulse width low time T_{LO} should be longer than 1 μs . The CAT4101 enters a “zero current” shutdown mode after a 5 ms delay (typical) when EN/PWM is held low.

CAT4101

TYPICAL PERFORMANCE CHARACTERISTICS

($V_{IN} = 5\text{ V}$, $V_{CC} = 5\text{ V}$, $V_F = 3.5\text{ V}$, $I_{LED} = 1\text{ A}$ (1 LED), $C_{IN} = 1\ \mu\text{F}$, $T_{AMB} = 25^\circ\text{C}$ unless otherwise specified.)

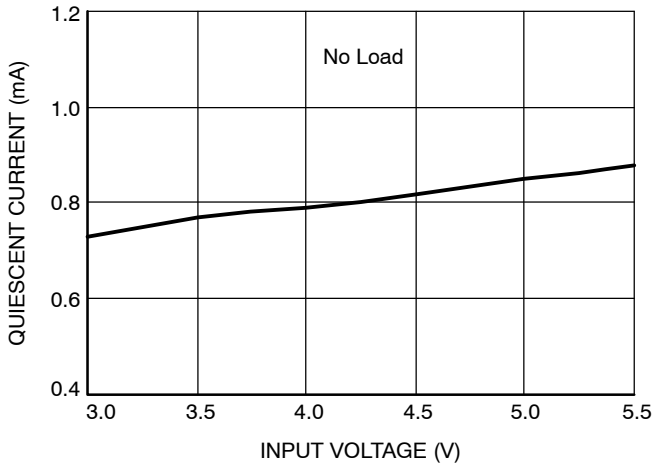

Figure 3. Quiescent Current vs. VIN Voltage ($I_{LED} = 0\text{ mA}$)

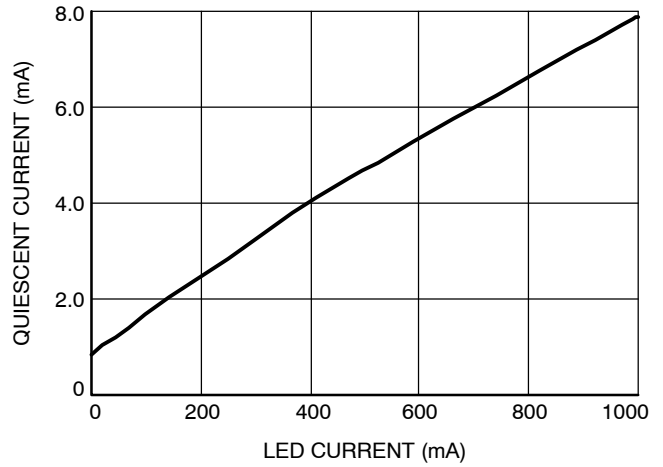

Figure 4. Quiescent Current vs. LED Current

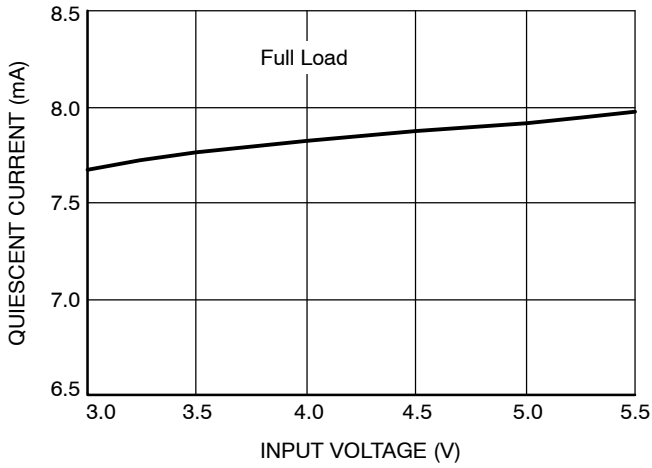

Figure 5. Quiescent Current vs. VIN Voltage (Full Load)

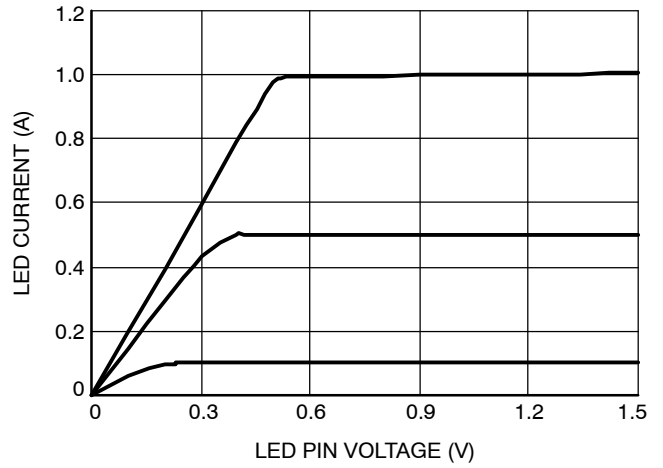

Figure 6. LED Current vs. LED Pin Voltage

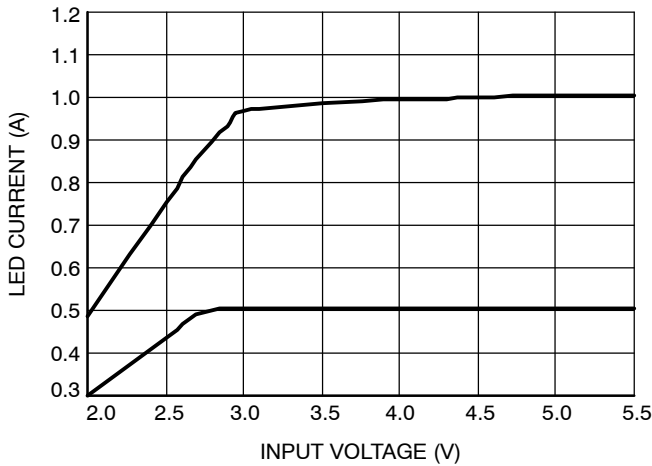

Figure 7. LED Current Change vs. VIN Voltage

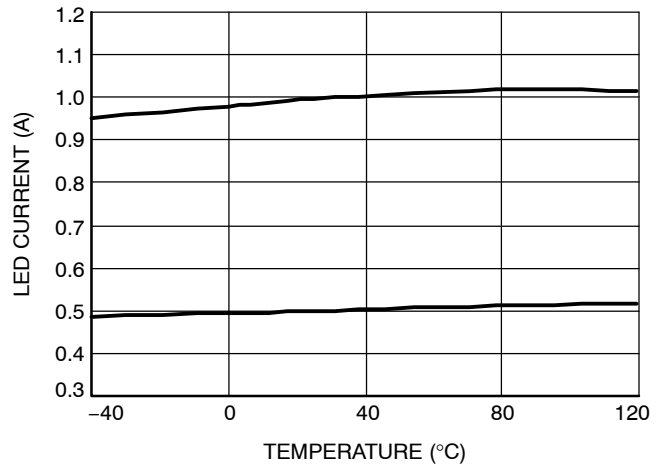

Figure 8. LED Current Change vs. Temperature

CAT4101

TYPICAL PERFORMANCE CHARACTERISTICS

($V_{IN} = 5\text{ V}$, $V_{CC} = 5\text{ V}$, $V_F = 3.5\text{ V}$, $I_{LED} = 1\text{ A}$ (1 LED), $C_{IN} = 1\text{ }\mu\text{F}$, $T_{AMB} = 25^\circ\text{C}$ unless otherwise specified.)

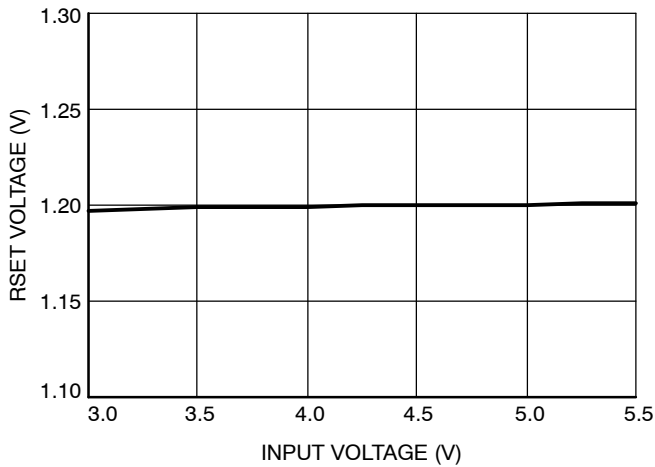

Figure 9. RSET Pin Voltage vs. VIN Voltage

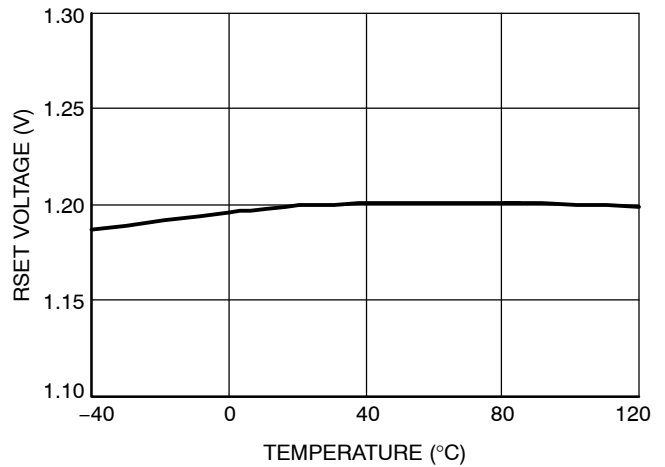

Figure 10. RSET Pin Voltage vs. Temperature

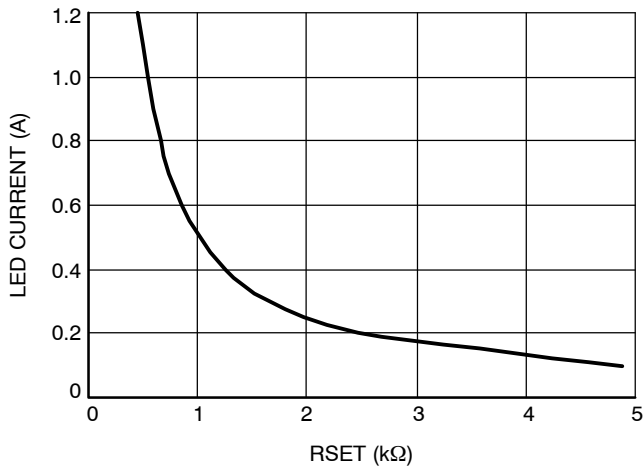

Figure 11. LED Current vs. RSET Resistor

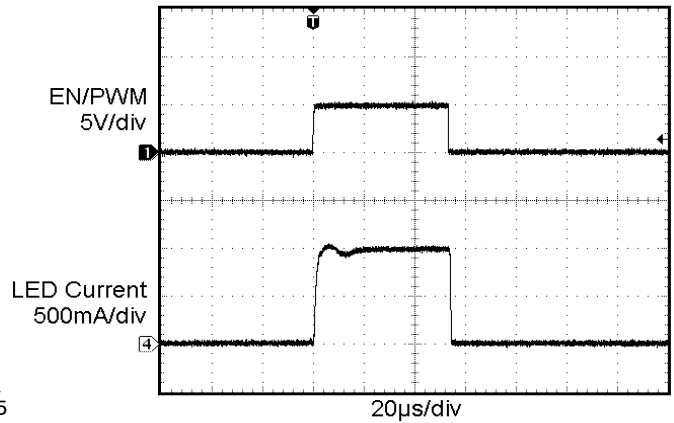

Figure 12. PWM 200 Hz, 1% Duty Cycle

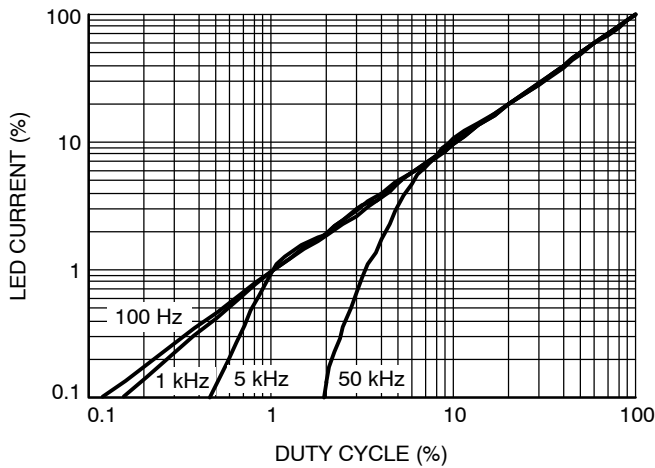

Figure 13. LED Current vs. PWM Duty Cycle

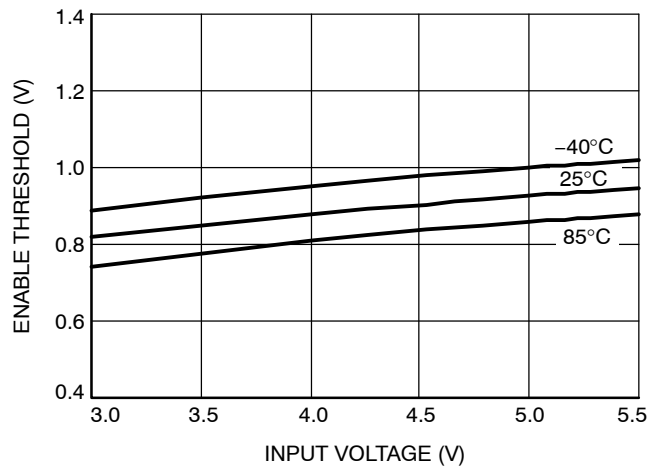

Figure 14. EN/PWM Threshold vs. VIN

CAT4101

Table 5. PIN DESCRIPTIONS

Name	Pin	Function
EN/PWM	1	Device enable (active high) and PWM control.
VIN	2	Device supply input, connect to battery or supply.
GND	3	Ground reference.
RSET	4	A resistor connected between this pin and ground sets the LED current.
LED	5	Bottom LED cathode terminal.
TAB	–	Connect TAB to the Ground plane.

Pin Function

VIN is the supply pin for the device. A small 0.1 μF ceramic bypass capacitor is optional for noisy environments. The maximum operating voltage is 6.0 V. Whenever the input supply falls below the under-voltage threshold, the current sink will automatically be disabled.

EN/PWM is the enable and one wire dimming input for the LED channel. Guaranteed levels of logic high and logic low are set at 1.3 V and 0.4 V respectively. When EN/PWM is initially taken high, the device becomes enabled and the LED current is set at a gain of 400 times the current in RSET. To place the device into zero current shutdown mode, the EN/PWM pin must be held low for 5 ms typical.

LED pin is connected to the bottom LED cathode and provides a regulated current sink. The pin enters a

high-impedance zero-current state whenever the device is placed in shutdown mode.

RSET pin is connected to an external resistor to set the LED current. The ground side of the external resistor should be star connected to the GND of the PCB. The pin source current mirrors the current to the LED sink. The voltage at this pin is regulated to 1.2 V.

GND is the ground reference for the device. The pin must be connected to the ground plane on the PCB.

TAB is the exposed pad underneath the package. For best thermal performance, the tab should be soldered to the PCB and connected to the ground plane.

CAT4101

Block Diagram

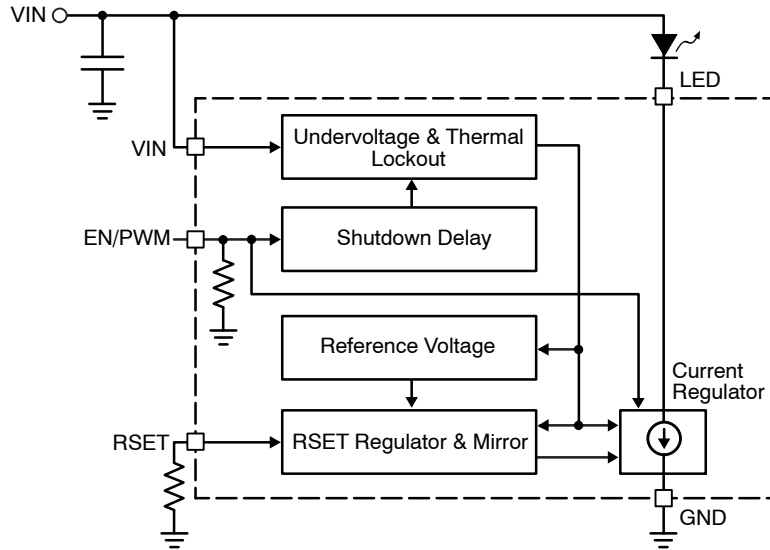

Figure 15. CAT4101 Functional Block Diagram

Basic Operation

The CAT4101 has one highly accurate LED current sink to regulate LED current in a string of LEDs. The LED current is mirrored from the current flowing from the RSET pin. Table 6 lists various RSET resistor values for LED current in 100 mA increments.

The LED channel needs a minimum of 500 mV headroom to sink constant regulated current. If the input supply falls below 2 V, the under-voltage lockout circuit disables the LED channel.

For applications requiring current higher than 1 A, several CAT4101 devices can be connected in parallel.

The LED channel can withstand and operate at voltages up to 25 V. This makes the device ideal for driving long strings of high power LEDs from a high voltage source.

Table 6. RSET RESISTOR SETTINGS

LED Current [mA]	RSET [Ω]
100	4990
200	2490
300	1690
400	1270
500	1050
600	866
700	768
800	680
900	604
1000	549

Application Information

Single 12 V Supply

The circuit shown in Figure 16 shows how to power three LEDs in series from a single 12 V supply using the CAT4101. The CAT4101 can not be driven directly from 12 V, three components are needed to create a lower voltage for the VIN pin (below 5.5 V). Resistor R2 and zener diode D provide a regulated voltage while the quiescent current runs through the N-Channel transistor M. Suitable parts for this circuit are the ON Semiconductor MM3Z6V2 zener diode and the 2N7002L N-channel transistor (SOT23 package).

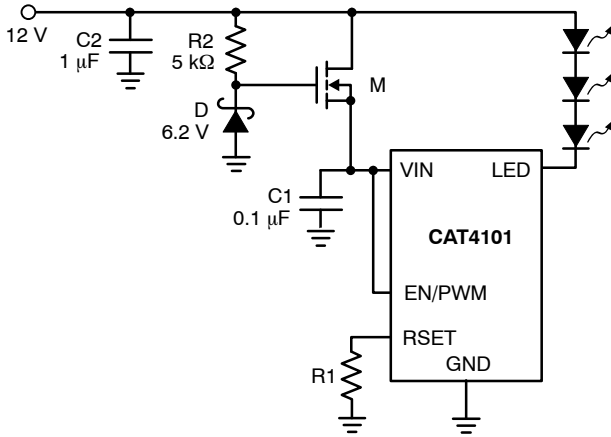

Figure 16. Single Supply Driving Three LEDs

Power Dissipation

The power dissipation (P_D) of the CAT4101 can be calculated as follows:

$$P_D = (V_{IN} \times I_{IN}) + (V_{LED} \times I_{LED})$$

where V_{LED} is the voltage at the LED pin. Combinations of high V_{LED} voltage or high ambient temperature can cause the CAT4101 to enter thermal shutdown. In applications where V_{LED} is high, a resistor can be inserted in series with the LED string to lower P_D .

Thermal dissipation of the junction heat consists primarily of two paths in series. The first path is the junction to the case (θ_{JC}) thermal resistance which is defined by the package style, and the second path is the case to ambient (θ_{CA}) thermal resistance, which is dependent on board layout. The overall junction to ambient (θ_{JA}) thermal resistance is equal to:

$$\theta_{JA} = \theta_{JC} + \theta_{CA}$$

For a given package style and board layout, the operating junction temperature T_J is a function of the power dissipation P_D , and the ambient temperature, resulting in the following equation:

$$T_J = T_{AMB} + P_D(\theta_{JC} + \theta_{CA}) = T_{AMB} + P_D \theta_{JA}$$

The CAT4101 TO-263 5-lead package provides a thermal resistance when the ground tab is soldered down to the PCB. When mounted on a double-sided printed circuit board with two square inches of copper allocated for “heat spreading”, the resulting θ_{JA} is about 30°C/W.

For example, at 60°C ambient temperature, the maximum power dissipation is calculated as follow:

$$P_{Dmax} = \frac{T_{Jmax} - T_{AMB}}{\theta_{JA}} = \frac{150 - 60}{30} = 3 \text{ W}$$

Recommended Layout

The board layout should provide good thermal dissipation through the PCB. Multiple via can be used to connect the tab of the CAT4101 to a large ground plane underneath the package.

Input capacitor C1 should be placed as close to the driver IC as possible. The RSET resistor should have a Kelvin connection to the GND pin of the CAT4101.

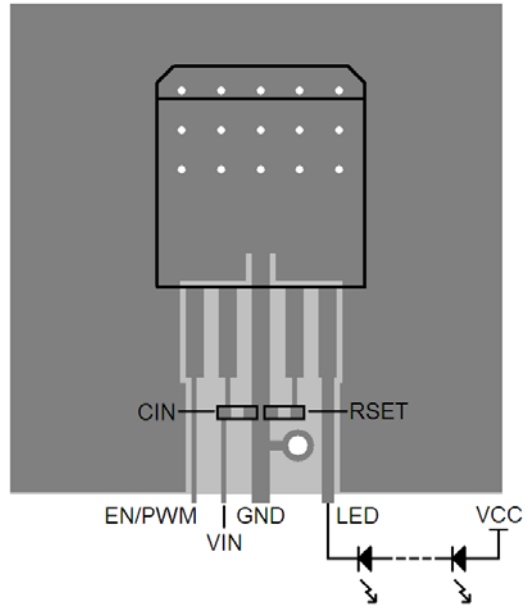

Figure 17. CAT4101 Recommended Layout

MECHANICAL CASE OUTLINE

PACKAGE DIMENSIONS

ON Semiconductor®



TO-263, 5 Lead
CASE 221AE-01
ISSUE O

DATE 19 DEC 2008

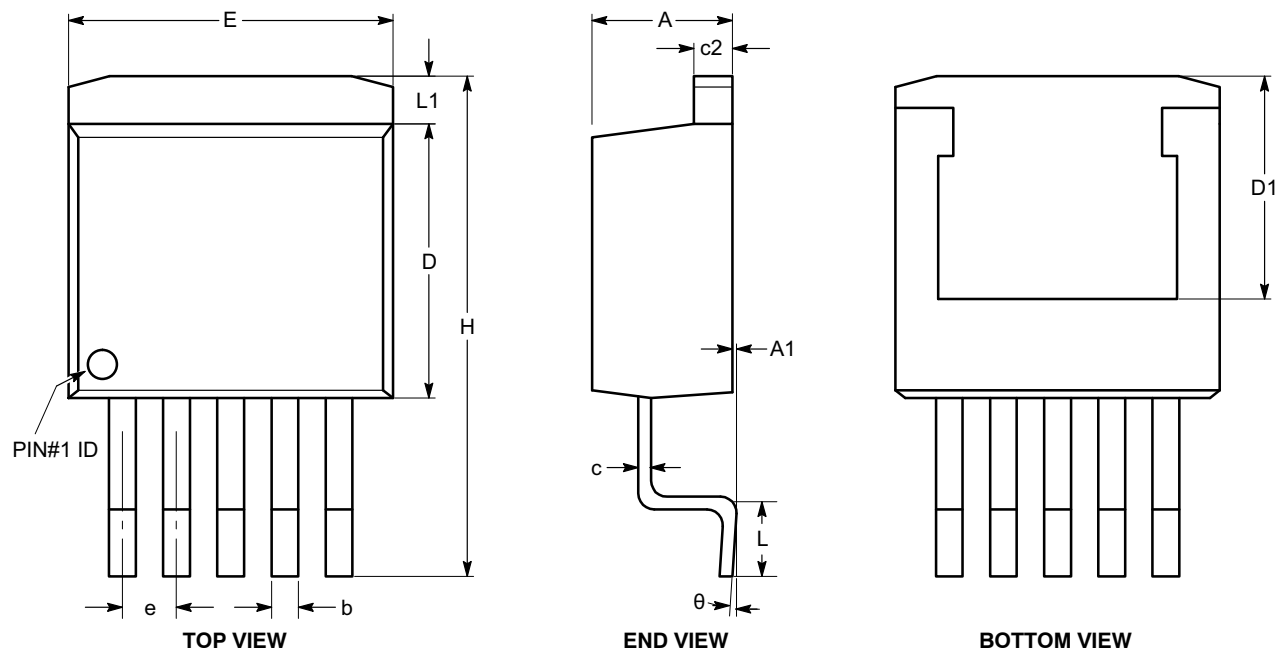

SYMBOL	MIN	NOM	MAX
A	4.20		4.80
A1	0.00		0.25
b	0.60		0.88
c	0.33		0.50
c2	1.15		1.60
D	8.40		9.60
D1	6.86		
E	9.80		10.67
e	1.70 BSC		
H	14.61		15.87
L	1.78		2.79
L1			1.67
θ	0°		8°

Notes:

- (1) All dimensions are in millimeters. Angles in degrees.
- (2) Complies with JEDEC standard TO-263.

DOCUMENT NUMBER:	98AON34372E	Electronic versions are uncontrolled except when accessed directly from the Document Repository. Printed versions are uncontrolled except when stamped "CONTROLLED COPY" in red.
DESCRIPTION:	TO-263, 5 LEAD	PAGE 1 OF 1

ON Semiconductor and are trademarks of Semiconductor Components Industries, LLC dba ON Semiconductor or its subsidiaries in the United States and/or other countries. ON Semiconductor reserves the right to make changes without further notice to any products herein. ON Semiconductor makes no warranty, representation or guarantee regarding the suitability of its products for any particular purpose, nor does ON Semiconductor assume any liability arising out of the application or use of any product or circuit, and specifically disclaims any and all liability, including without limitation special, consequential or incidental damages. ON Semiconductor does not convey any license under its patent rights nor the rights of others.

onsemi, **Onsemi**, and other names, marks, and brands are registered and/or common law trademarks of Semiconductor Components Industries, LLC dba "**onsemi**" or its affiliates and/or subsidiaries in the United States and/or other countries. **onsemi** owns the rights to a number of patents, trademarks, copyrights, trade secrets, and other intellectual property. A listing of **onsemi**'s product/patent coverage may be accessed at www.onsemi.com/site/pdf/Patent-Marking.pdf. **onsemi** reserves the right to make changes at any time to any products or information herein, without notice. The information herein is provided "as-is" and **onsemi** makes no warranty, representation or guarantee regarding the accuracy of the information, product features, availability, functionality, or suitability of its products for any particular purpose, nor does **onsemi** assume any liability arising out of the application or use of any product or circuit, and specifically disclaims any and all liability, including without limitation special, consequential or incidental damages. Buyer is responsible for its products and applications using **onsemi** products, including compliance with all laws, regulations and safety requirements or standards, regardless of any support or applications information provided by **onsemi**. "Typical" parameters which may be provided in **onsemi** data sheets and/or specifications can and do vary in different applications and actual performance may vary over time. All operating parameters, including "Typicals" must be validated for each customer application by customer's technical experts. **onsemi** does not convey any license under any of its intellectual property rights nor the rights of others. **onsemi** products are not designed, intended, or authorized for use as a critical component in life support systems or any FDA Class 3 medical devices or medical devices with a same or similar classification in a foreign jurisdiction or any devices intended for implantation in the human body. Should Buyer purchase or use **onsemi** products for any such unintended or unauthorized application, Buyer shall indemnify and hold **onsemi** and its officers, employees, subsidiaries, affiliates, and distributors harmless against all claims, costs, damages, and expenses, and reasonable attorney fees arising out of, directly or indirectly, any claim of personal injury or death associated with such unintended or unauthorized use, even if such claim alleges that **onsemi** was negligent regarding the design or manufacture of the part. **onsemi** is an Equal Opportunity/Affirmative Action Employer. This literature is subject to all applicable copyright laws and is not for resale in any manner.

ADDITIONAL INFORMATION

TECHNICAL PUBLICATIONS:

Technical Library: www.onsemi.com/design/resources/technical-documentation
onsemi Website: www.onsemi.com

ONLINE SUPPORT: www.onsemi.com/support

For additional information, please contact your local Sales Representative at www.onsemi.com/support/sales

