

CAT4004

LED Driver, Constant Current, 4-Channel with EZDim™

Description

The CAT4004 provides four matched low dropout current sources to drive LEDs. An external resistor on RSET sets the current in the LED channels. Each LED channel includes an individual control loop allowing the device to handle a wide range of LED forward voltages while still maintaining tight current matching.

The EN/DIM logic inputs supports device enable and a digital dimming interface for current setting of all LEDs. Six different current dimming ratios are available.

The device is aimed at “direct drive” battery applications. It is required that the battery or voltage source have enough headroom to drive the LED forward voltage and current sink (>150 mV).

The device is available in a tiny-l8ad TDFN 2 mm x 3 mm package with a max height of 0.8 mm.

Features

- Four LED Current Sinks with Tight Matching
- Low Dropout Driver 130 mV at 30 mA
- No Switching Noise
- Shutdown Current < 1 μ A
- LED Current set by External Resistor
- Dimming via 1-wire EZDim™ Interface
- Thermal Shutdown Protection
- 8-lead 2 mm x 3 mm TDFN Package
- These Devices are Pb-Free, Halogen Free/BFR Free and are RoHS Compliant

Applications

- LCD Display Backlight
- Cellular Phones
- Digital Still Cameras
- Handheld Devices

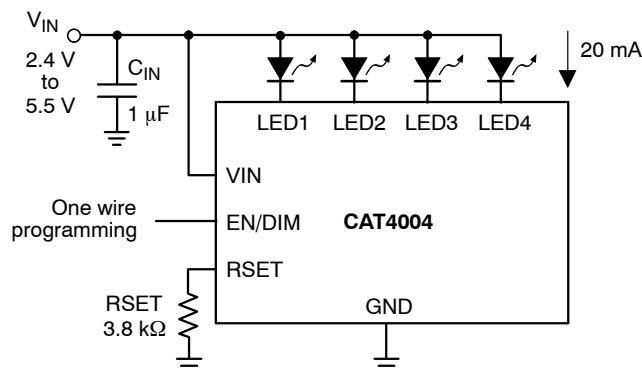

Figure 1. Typical Application Circuit



ON Semiconductor®

<http://onsemi.com>



TDFN-8
VP2 SUFFIX
CASE 511AK

PIN CONNECTIONS

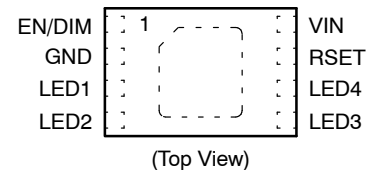

MARKING DIAGRAMS

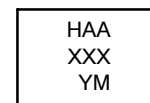
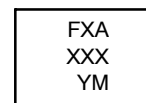

FX = CAT4004VP2-T3
HA = CAT4004VP2-GT3
A = Assembly Location
XXX = Last Three Digits of Assembly Lot Number
Y = Production Year (Last Digit)
M = Production Month (1-9, A, B, C)

ORDERING INFORMATION

Device	Package	Shipping
CAT4004VP2-T3 (Note 1)	TDFN-8 (Pb-Free)	3,000/ Tape & Reel
CAT4004VP2-GT3 (Note 2)	TDFN-8 (Pb-Free)	3,000/ Tape & Reel

1. Matte-Tin Plated Finish (RoHS-compliant).
2. NiPdAu Plated Finish (RoHS-compliant).

CAT4004

Table 1. ABSOLUTE MAXIMUM RATINGS

Parameter	Rating	Unit
V _{IN} , LED _x , RSET	6	V
EN/DIM Voltage	V _{IN} + 0.7	V
Storage Temperature Range	-65 to +160	°C
Junction Temperature Range	-40 to +150	°C
Lead Temperature	300	°C

Stresses exceeding Maximum Ratings may damage the device. Maximum Ratings are stress ratings only. Functional operation above the Recommended Operating Conditions is not implied. Extended exposure to stresses above the Recommended Operating Conditions may affect device reliability.

Table 2. RECOMMENDED OPERATING CONDITIONS

Parameter	Rating	Unit
V _{IN}	2.4 to 5.5	V
Ambient Temperature Range	-40 to +85	°C
I _{LED} per LED pin	0 to 40	mA

NOTE: Typical application circuit with external components is shown on page 1.

Table 3. ELECTRICAL OPERATING CHARACTERISTICS

(over recommended operating conditions unless specified otherwise) V_{IN} = 4.0 V, EN = High, T_{AMB} = 25°C

Symbol	Name	Conditions	Min	Typ	Max	Units
I _Q	Quiescent Current	No load, RSET = Float No load, RSET = 4.8 kΩ		0.6 1.0		mA
I _{QSHDN}	Shutdown Current	V _{EN} = 0 V			1	μA
I _{LED-ACC}	LED Current Accuracy	1 mA ≤ I _{LED} ≤ 40 mA		±1		%
I _{LED-DEV}	LED Channel Matching	$\frac{I_{LED} - I_{LEDAVG}}{I_{LED}}$	-5	±1	+5	%
V _{DOUT}	Dropout Voltage	I _{LED} = 30 mA		130		mV
R _{EN/DIM} V _{HI} V _{LO}	EN/DIM Pin – Internal pull-down resistor – Logic High Level – Logic Low Level		1.3	100	0.4	kΩ V V
T _{SD}	Thermal Shutdown			150		°C
T _{HYS}	Thermal Hysteresis			20		°C
V _{UVLO}	Undervoltage lockout (UVLO) threshold			1.8		V

CAT4004

Table 4. RECOMMENDED EN/DIM TIMING

(For $2.4 \leq V_{IN} \leq 5.5$ V, over full ambient temperature range -40°C to $+85^{\circ}\text{C}$.)

Symbol	Name	Conditions	Min	Typ	Max	Units
T_{SETUP}	EN/DIM setup from shutdown		10			μs
T_{LO}	EN/DIM program low time		0.2		100	μs
T_{HI}	EN/DIM program high time		0.2			μs
T_{PWRDWN}	EN/DIM low time to shutdown		1.5			ms
T_{LED}	LED current settling time			40		μs

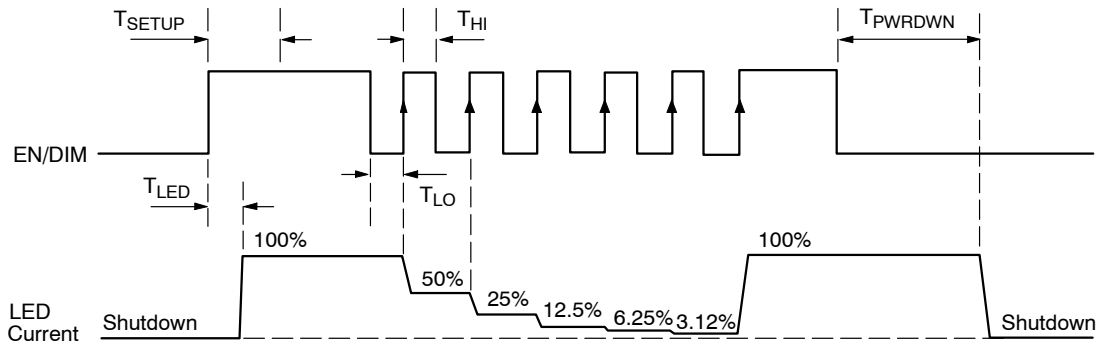

Figure 2. EN/DIM Dimming Timing Diagram

EN/DIM Number of Pulses (Note 3)	R _{SET} Gain	LED Current
LOW	Shutdown mode	Zero
Transitions HIGH	132	$132 \times 0.6 \text{ V/R}_{\text{SET}}$
1 st	66	$66 \times 0.6 \text{ V/R}_{\text{SET}}$
2 nd	33	$33 \times 0.6 \text{ V/R}_{\text{SET}}$
3 rd	16.5	$16.5 \times 0.6 \text{ V/R}_{\text{SET}}$
4 th	8.25	$8.25 \times 0.6 \text{ V/R}_{\text{SET}}$
5 th	4.125	$4.125 \times 0.6 \text{ V/R}_{\text{SET}}$
6 th	132	$132 \times 0.6 \text{ V/R}_{\text{SET}}$
x th	Device will keep cycling through gain selection	$\text{GAIN} \times 0.6 \text{ V/R}_{\text{SET}}$

3. The gain is changed on the rising edges of the EN/DIM input.

LED Current Selection

At power-up, the initial LED current is set to full scale (100% brightness) by the external resistor R_{SET} as follows:

$$\text{LED current} = 132 \times \frac{0.6 \text{ V}}{\text{R}_{\text{SET}}}$$

The EN/DIM pin has two primary functions. One function enables and disables the device. The other function is LED current dimming with six different levels by pulsing the

input signal, as shown on Figure 2. On each consecutive pulse rising edge, the LED current is divided by half to 50%, then 25%, 12.5%, 6.25% and 3.125% dimming levels. Pulses faster than the minimum T_{LO} may be ignored and filtered by the device. Pulses longer than the maximum T_{LO} may shutdown the device.

The LED driver enters a “zero current” shutdown mode if EN/DIM is held low for 1.5 ms or more.

CAT4004

TYPICAL PERFORMANCE CHARACTERISTICS

($V_{IN} = 4\text{ V}$, $V_F = 3.3\text{ V}$, $I_{OUT} = 80\text{ mA}$ (4 LEDs at 20 mA), $C_{IN} = 1\text{ }\mu\text{F}$, $T_{AMB} = 25^\circ\text{C}$ unless otherwise specified.)

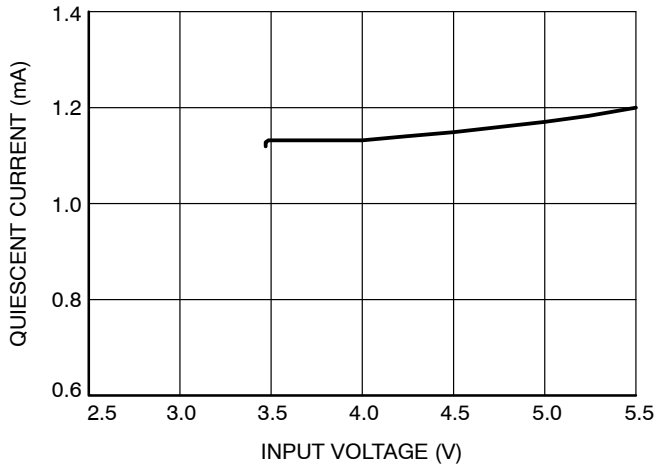

Figure 3. Quiescent Current vs. Input Voltage

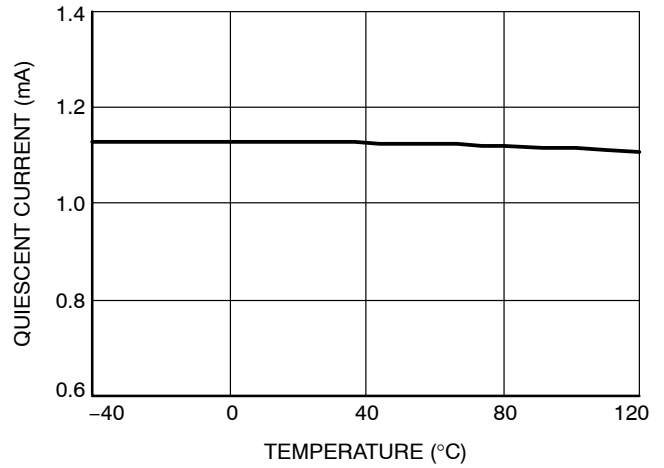

Figure 4. Quiescent Current vs. Temperature

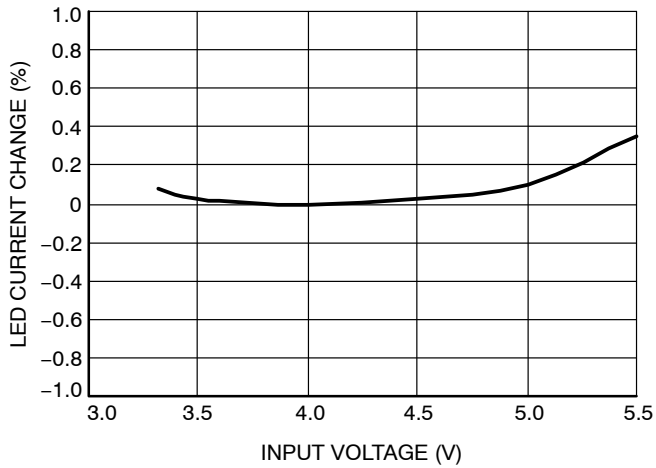

Figure 5. LED Current Change vs. Input Voltage

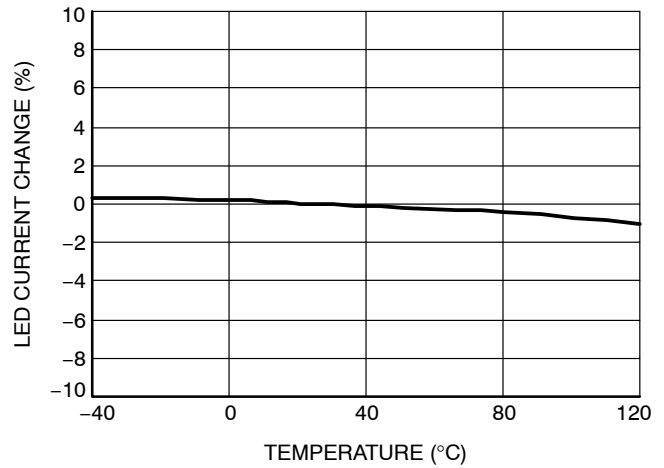

Figure 6. LED Current Change vs. Temperature

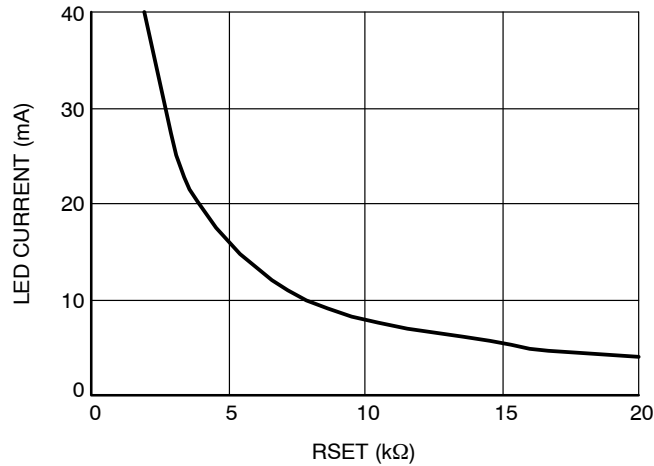

Figure 7. LED Current vs. RSET Resistor

CAT4004

TYPICAL PERFORMANCE CHARACTERISTICS

($V_{IN} = 4\text{ V}$, $V_F = 3.3\text{ V}$, $I_{OUT} = 80\text{ mA}$ (4 LEDs at 20 mA), $C_{IN} = 1\text{ }\mu\text{F}$, $T_{AMB} = 25^\circ\text{C}$ unless otherwise specified.)

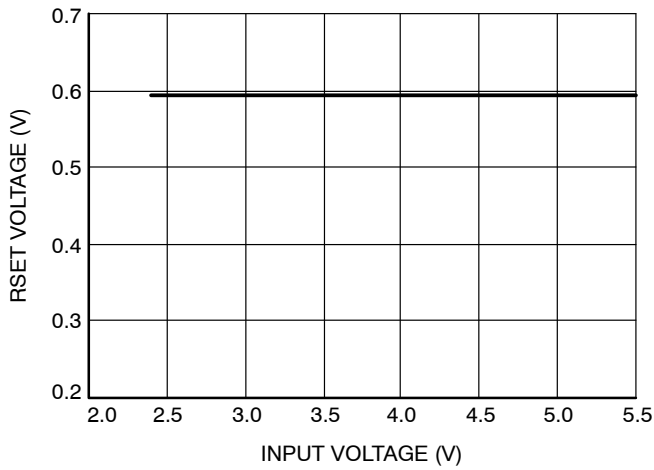

Figure 8. RSET Pin Voltage vs. Input Voltage

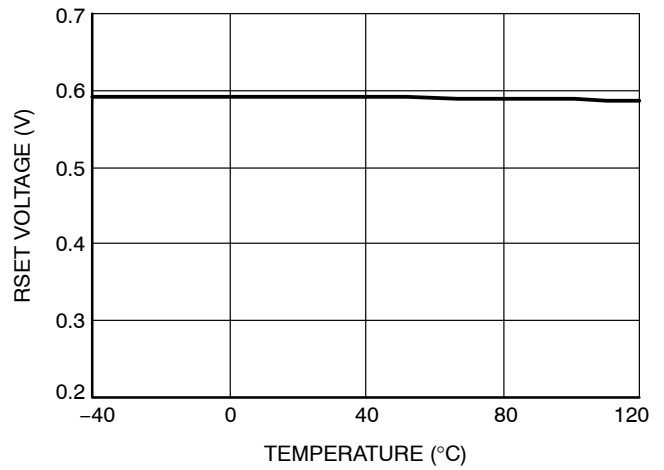

Figure 9. RSET Pin Voltage vs. Temperature

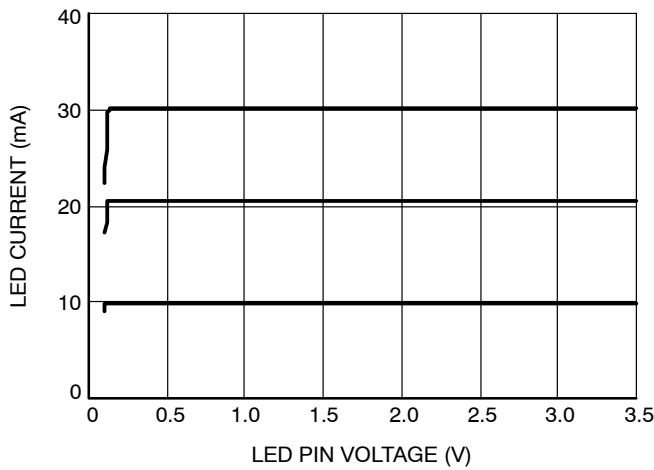

Figure 10. LED Current vs. LED Pin Voltage

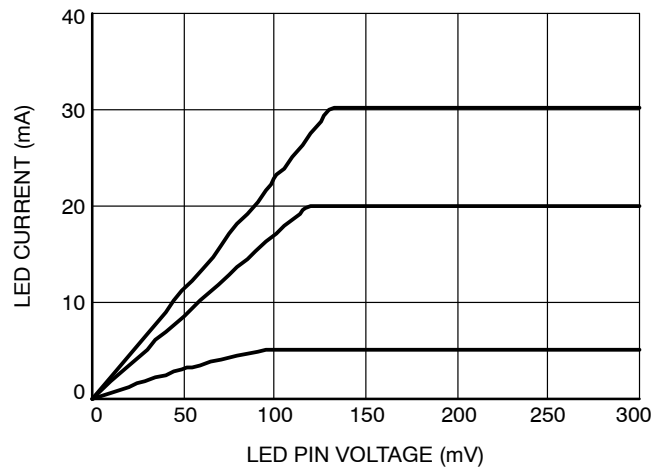

Figure 11. Dropout Characteristics

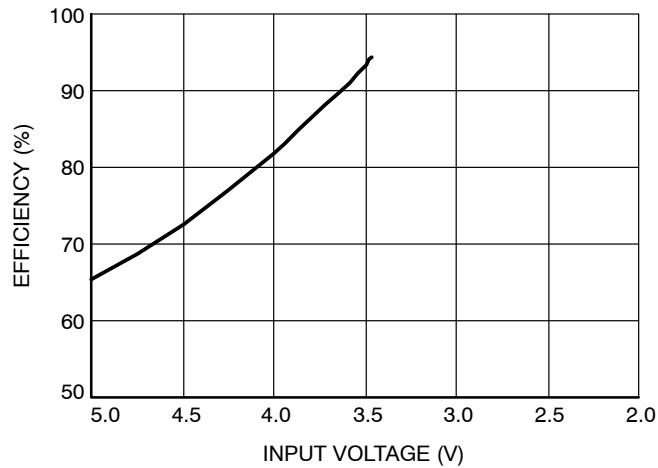

Figure 12. Efficiency vs. Input Voltage

CAT4004

TYPICAL PERFORMANCE CHARACTERISTICS

($V_{IN} = 4\text{ V}$, $V_F = 3.3\text{ V}$, $I_{OUT} = 80\text{ mA}$ (4 LEDs at 20 mA), $C_{IN} = 1\text{ }\mu\text{F}$, $T_{AMB} = 25^\circ\text{C}$ unless otherwise specified.)

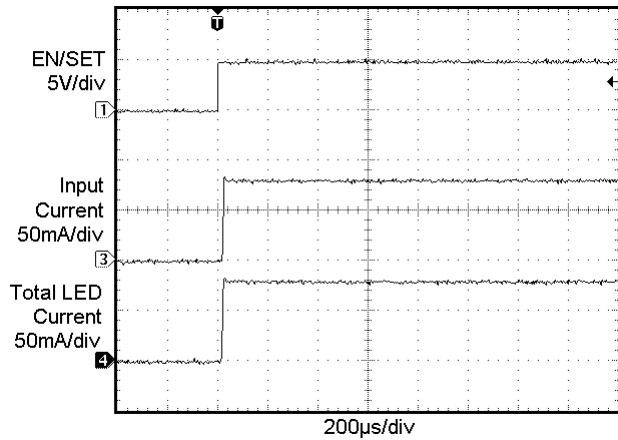

Figure 13. Power Up Waveform

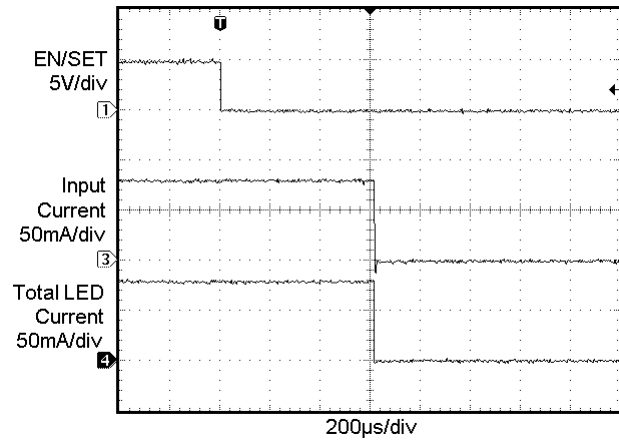

Figure 14. Power Down Waveform

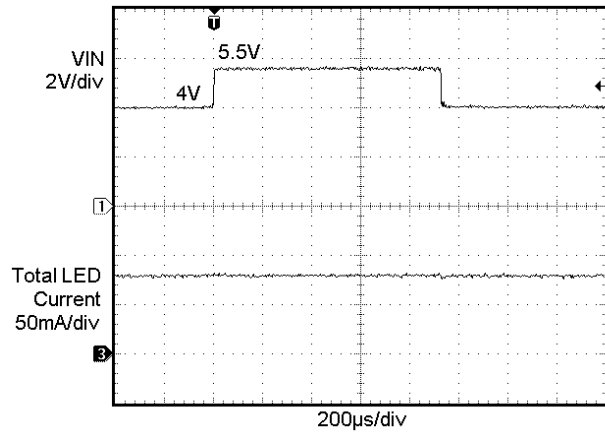

Figure 15. Line Transient Waveform
4 V to 5.5 V

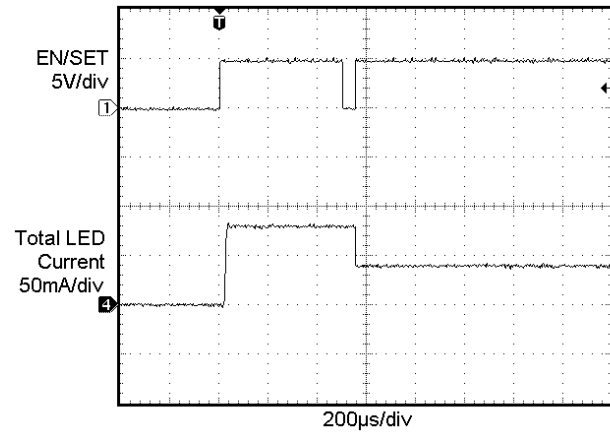

Figure 16. Dimming Waveform 80 mA to 40 mA

Table 5. PIN DESCRIPTIONS

Pin #	Name	Function
1	EN/DIM	Device enable (active high) and dimming control
2	GND	Ground reference
3	LED1	LED1 cathode terminal
4	LED2	LED2 cathode terminal
5	LED3	LED3 cathode terminal
6	LED4	LED4 cathode terminal
7	RSET	RSET external LED mirror gain 128
8	VIN	Device supply input, connect to battery or supply
TAB	TAB	Connect to GND on the PCB

Pin Function

VIN is the supply pin for the device logic. A small 1 μ F ceramic bypass capacitor is required between the VIN pin and ground near the device. The operating input voltage range is from 2.5 V to 5.5 V. Whenever the input supply falls below the under-voltage threshold (1.8 V), all the LED channels are disabled and the device enters shutdown mode.

EN/DIM is the enable and one wire dimming input for all LED channels. Levels of logic high and logic low are set at 1.3 V and 0.4 V respectively. When EN/DIM is initially taken high, the device becomes enabled and all LED currents are set to the full scale according to the resistor RSET. To place the device into “zero current” shutdown mode, the EN/DIM pin must be held low for at least 1.5 ms.

LED1 to LED4 provide the internal regulated current for each of the LED cathodes. These pins enter a high

impedance zero current state whenever the device is placed in shutdown mode.

RSET is connected to the resistor (RSET) to set the full scale current for the LEDs. The voltage at this pin is regulated to 0.6 V. The ground side of the external resistor should be star connected back to the GND of the PCB. In shutdown mode, RSET becomes high impedance.

GND is the ground reference for the device. The pin must be connected to the ground plane on the PCB.

TAB is the exposed pad underneath the package. For best thermal performance, the tab should be soldered to the PCB and connected to the ground plane.

CAT4004

Block Diagram

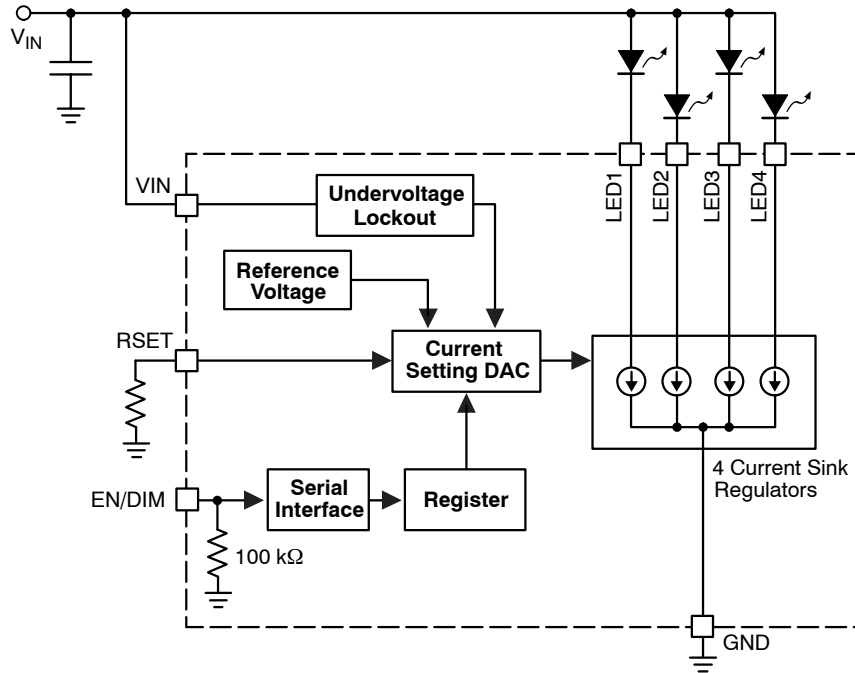

Figure 17. CAT4004 Functional Block Diagram

Basic Operation

The CAT4004 uses four tightly matched current sinks to accurately regulate LED current in each channel proportional to the current sourced from the RSET pin.

$$I_{LED} = GAIN \times \frac{0.6 V}{R_{SET}}$$

There are six different gain settings for LED brightness that can be set through the EN/DIM pin. The default gain on

power-up is 132. Tight current regulation for all channels is possible over a wide range of input and LED voltages due to independent current sensing circuitry on each channel.

Each LED channel needs a minimum of 150 mV headroom to sink constant regulated current. If the input supply falls below 1.8 V, the under-voltage lockout circuit disables all LED channels and resets the circuit to default values. Any unused LED channels should be left open.

CAT4004

Example of Ordering Information (Note 6)

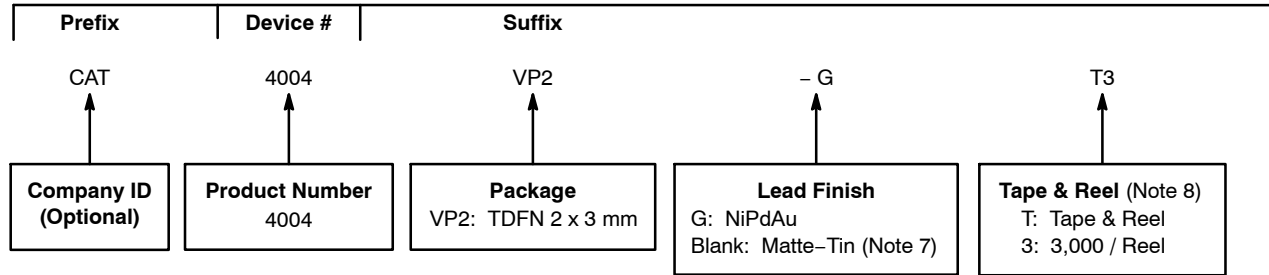

4. All packages are RoHS-compliant (Lead-free, Halogen-free).
5. The standard lead finish is NiPdAu.
6. The device used in the above example is a CAT4004VP2-GT3 (TDFN, NiPdAu Plated Finish, Tape & Reel, 3,000/Reel).
7. For Matte-Tin package option, please contact your nearest ON Semiconductor Sales office.
8. For information on tape and reel specifications, including part orientation and tape sizes, please refer to our Tape and Reel Packaging Specifications Brochure, BRD8011/D.

MECHANICAL CASE OUTLINE

PACKAGE DIMENSIONS

ON Semiconductor®



SCALE 2:1

TDFN8, 2x3, 0.5P
CASE 511AK
ISSUE B

DATE 18 MAR 2015

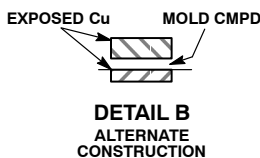
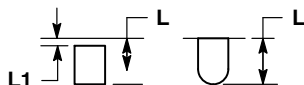
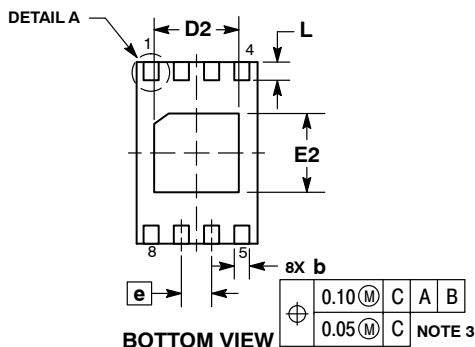
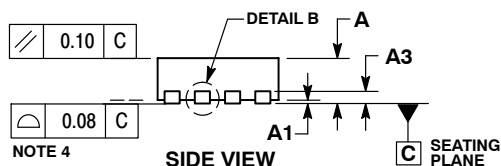
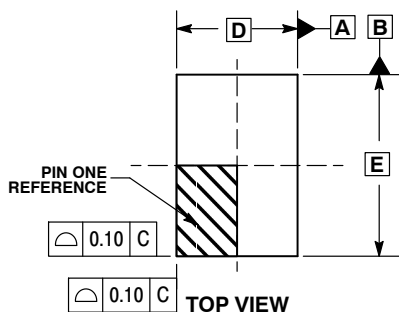

NOTES:

1. DIMENSIONING AND TOLERANCING PER ASME Y14.5M, 1994.
2. CONTROLLING DIMENSION: MILLIMETERS.
3. DIMENSION b APPLIES TO PLATED TERMINAL AND IS MEASURED BETWEEN 0.15 AND 0.25MM FROM THE TERMINAL TIP.
4. COPLANARITY APPLIES TO THE EXPOSED PAD AS WELL AS THE TERMINALS.

DIM	MILLIMETERS	
	MIN	MAX
A	0.70	0.80
A1	0.00	0.05
A3	0.20 REF	
b	0.20	0.30
D	2.00 BSC	
D2	1.30	1.50
E	3.00 BSC	
E2	1.20	1.40
e	0.50 BSC	
L	0.20	0.40
L1	---	0.15

GENERIC MARKING DIAGRAM*

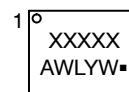

- XXXXX = Specific Device Code
- A = Assembly Location
- WL = Wafer Lot
- Y = Year
- W = Work Week
- = Pb-Free Package

*This information is generic. Please refer to device data sheet for actual part marking. Pb-Free indicator, "G" or microdot "▪", may or may not be present.

RECOMMENDED SOLDERING FOOTPRINT*

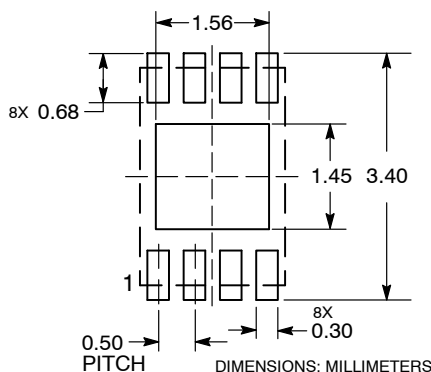

*For additional information on our Pb-Free strategy and soldering details, please download the ON Semiconductor Soldering and Mounting Techniques Reference Manual, SOLDERRM/D.

DOCUMENT NUMBER:	98AON34336E	Electronic versions are uncontrolled except when accessed directly from the Document Repository. Printed versions are uncontrolled except when stamped "CONTROLLED COPY" in red.
DESCRIPTION:	TDFN8, 2X3, 0.5P	PAGE 1 OF 1

ON Semiconductor and ON are trademarks of Semiconductor Components Industries, LLC dba ON Semiconductor or its subsidiaries in the United States and/or other countries. ON Semiconductor reserves the right to make changes without further notice to any products herein. ON Semiconductor makes no warranty, representation or guarantee regarding the suitability of its products for any particular purpose, nor does ON Semiconductor assume any liability arising out of the application or use of any product or circuit, and specifically disclaims any and all liability, including without limitation special, consequential or incidental damages. ON Semiconductor does not convey any license under its patent rights nor the rights of others.

onsemi, **Onsemi**, and other names, marks, and brands are registered and/or common law trademarks of Semiconductor Components Industries, LLC dba "**onsemi**" or its affiliates and/or subsidiaries in the United States and/or other countries. **onsemi** owns the rights to a number of patents, trademarks, copyrights, trade secrets, and other intellectual property. A listing of **onsemi**'s product/patent coverage may be accessed at www.onsemi.com/site/pdf/Patent-Marking.pdf. **onsemi** reserves the right to make changes at any time to any products or information herein, without notice. The information herein is provided "as-is" and **onsemi** makes no warranty, representation or guarantee regarding the accuracy of the information, product features, availability, functionality, or suitability of its products for any particular purpose, nor does **onsemi** assume any liability arising out of the application or use of any product or circuit, and specifically disclaims any and all liability, including without limitation special, consequential or incidental damages. Buyer is responsible for its products and applications using **onsemi** products, including compliance with all laws, regulations and safety requirements or standards, regardless of any support or applications information provided by **onsemi**. "Typical" parameters which may be provided in **onsemi** data sheets and/or specifications can and do vary in different applications and actual performance may vary over time. All operating parameters, including "Typicals" must be validated for each customer application by customer's technical experts. **onsemi** does not convey any license under any of its intellectual property rights nor the rights of others. **onsemi** products are not designed, intended, or authorized for use as a critical component in life support systems or any FDA Class 3 medical devices or medical devices with a same or similar classification in a foreign jurisdiction or any devices intended for implantation in the human body. Should Buyer purchase or use **onsemi** products for any such unintended or unauthorized application, Buyer shall indemnify and hold **onsemi** and its officers, employees, subsidiaries, affiliates, and distributors harmless against all claims, costs, damages, and expenses, and reasonable attorney fees arising out of, directly or indirectly, any claim of personal injury or death associated with such unintended or unauthorized use, even if such claim alleges that **onsemi** was negligent regarding the design or manufacture of the part. **onsemi** is an Equal Opportunity/Affirmative Action Employer. This literature is subject to all applicable copyright laws and is not for resale in any manner.

ADDITIONAL INFORMATION

TECHNICAL PUBLICATIONS:

Technical Library: www.onsemi.com/design/resources/technical-documentation
onsemi Website: www.onsemi.com

ONLINE SUPPORT: www.onsemi.com/support

For additional information, please contact your local Sales Representative at www.onsemi.com/support/sales