

CAT3603

3-Channel LED Driver in 3 x 3 mm Package

Description

The CAT3603 is a charge pump LED driver operating in either 1x (LDO) mode or 1.5x fractional mode regulating current through each of the 3 LED pins. Operation at a constant switching frequency of 1 MHz allows the use of very small value ceramic capacitors.

The CAT3603 drives 3 white LEDs in parallel and provides tightly matched regulated current to achieve uniform brightness in LCD backlighting applications. An external resistor, RSET, controls the output current level. The device can deliver up to 30 mA over an input voltage supply range from 3 V to 5.5 V, making it ideal for battery-powered applications.

LED dimming can be accomplished using several methods; using a DC voltage to set the RSET pin current, applying a PWM signal on the EN pin, or adding a switched resistor in parallel with RSET. The EN input pin allows the device to be placed in power-down mode with “near-zero” quiescent current.

The device is available in the tiny 12-lead thin DFN 3 mm x 3 mm package with a max height of 0.8 mm.

Features

- Drives up to 3 LEDs
- Current Setting Resistor
- Compatible with Supply Voltage of 3 V to 5.5 V
- Power Efficiency up to 91%
- Output Current up to 30 mA per LED
- Fractional Pump 1x/1.5x
- Low Noise Input Ripple
- Fixed High Frequency Operation 1 MHz
- “Zero” Current Shutdown Mode
- Soft Start and Current Limiting
- Short Circuit Protection
- 12-lead TDFN 3 mm x 3 mm Package
- This Device is Pb-Free, Halogen Free/BFR Free and RoHS Compliant

Applications

- LCD Display Backlight
- Cellular Phones
- Digital Still Cameras
- Handheld Devices



ON Semiconductor®

<http://onsemi.com>

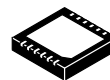

TDFN-12
HV2 SUFFIX
CASE 511AN

PIN CONNECTIONS

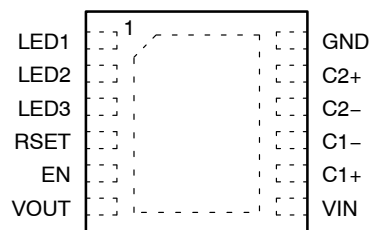

(Top View)

MARKING DIAGRAM



HABB = CAT3603 Device Code

ORDERING INFORMATION

Device	Package	Shipping
CAT3603HV2	TDFN-12 (Pb-Free) Green*	2,000/Tape & Reel

* Lead Finish Matte-Tin

CAT3603

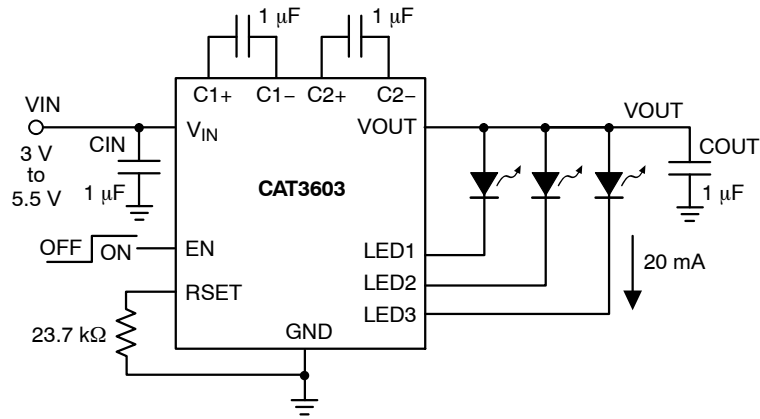

Note: Unused LED channels must be connected to VOUT.

Figure 1. Typical Application Circuit

Table 1. ABSOLUTE MAXIMUM RATINGS

Parameter	Rating	Unit
VIN, VOUT, LEDx voltage	-0.3 to 7.0	V
EN voltage	-0.3 to VIN	V
RSET voltage	-0.3 to VIN	V
Junction Temperature Range	-40 to +150	°C
Storage Temperature Range	-65 to +160	°C
Lead Temperature	300	°C
ESD Rating HBM (Human Body Model)	2,000	V
ESD Rating MM (Machine Model)	200	V

Stresses exceeding Maximum Ratings may damage the device. Maximum Ratings are stress ratings only. Functional operation above the Recommended Operating Conditions is not implied. Extended exposure to stresses above the Recommended Operating Conditions may affect device reliability.

Table 2. RECOMMENDED OPERATING CONDITIONS

Parameter	Range	Unit
VIN	3 to 5.5	V
Ambient Temperature Range	-40 to +85	°C
Input, Output, Bucket Capacitors	1 ±20% typical	µF
I _{LED} per LED pin	0 to 30	mA

1. Typical application circuit with external components is shown above.

CAT3603

Table 3. ELECTRICAL OPERATING CHARACTERISTICS

(VIN = 3.6 V, EN = High, TAMB = 25°C over recommended operating conditions unless otherwise stated.)

Symbol	Parameter	Conditions	Min	Typ	Max	Units
IQ	Quiescent Current	V _{EN} = 0 V, shutdown mode		0.1	1	μA
		1x Mode, No Load		0.4	1	mA
		1.5x Mode, No Load		2.7	5	mA
V _{RSET}	RSET Regulated Voltage		1.17	1.2	1.23	V
I _{LED}	Programmed LED Current	I _{RSET} = 5 μA		2.4		mA
		I _{RSET} = 37 μA		15.0		
		I _{RSET} = 78 μA		30.0		
I _{LED-ACC}	LED Current Accuracy	0.5 mA ≤ I _{LED} ≤ 3 mA 3 mA ≤ I _{LED} ≤ 30 mA		±15 ±5		%
I _{LED-DEV}	LED Channel Matching	(I _{LED} - I _{LEDAVG}) / I _{LEDAVG}		±3		%
R _{OUT}	Output Resistance (Open Loop)	1x Mode		1.4	2.5	Ω
		1.5x Mode, I _{OUT} = 100 mA		6.5	10	
f _{OSC}	Charge Pump Frequency		0.8	1.0	1.3	MHz
T _{DROPOUT}	1x to 1.5x Mode Transition Dropout Delay		0.4	0.6	0.9	ms
I _{EN}	Input Leakage Current	On Input EN			1	μA
V _{EN}	High Detect Threshold Low Detect Threshold	On Input EN		0.8 0.7	1.3	V
			0.4			
I _{SC}	Short Circuit Output Current	V _{OUT} = GND	30	45	60	mA
I _{LIM}	Maximum Input Current	V _{OUT} > 1 V	200	400	600	mA
T _{SD}	Thermal Shutdown			150		°C
T _{HYS}	Thermal Hysteresis			20		°C
V _{UVLO}	Undervoltage lock out (UVLO) threshold			2		V

CAT3603

TYPICAL CHARACTERISTICS

(VIN = 3.6 V, IOUT = 60 mA (3 LEDs at 20 mA), C1 = C2 = CIN = COUT = 1 μF, TAMB = 25°C unless otherwise specified.)

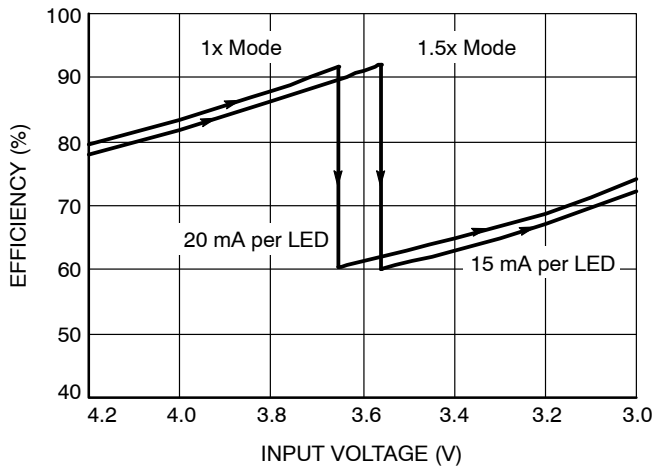

Figure 2. Efficiency vs. Input Voltage (3 LEDs on)

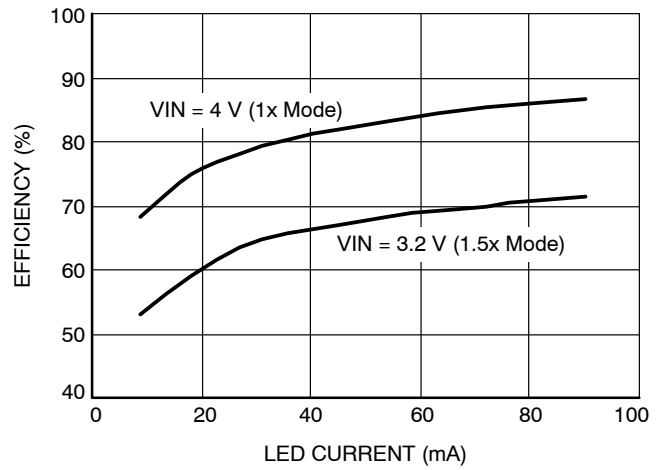

Figure 3. Efficiency vs. Total LED Current (3 LEDs)

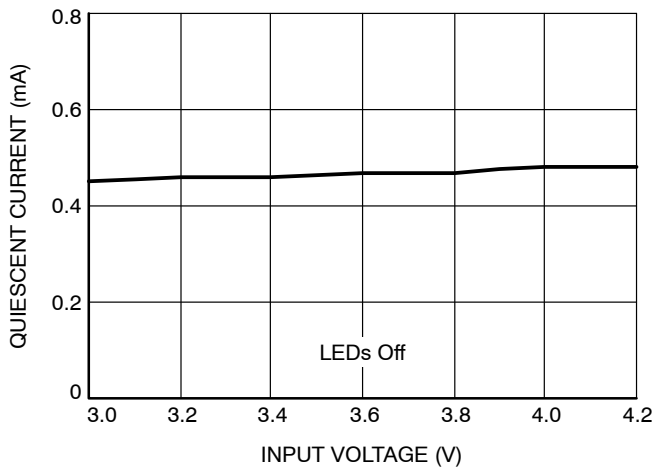

Figure 4. Quiescent Current vs. Input Voltage (1x Mode)

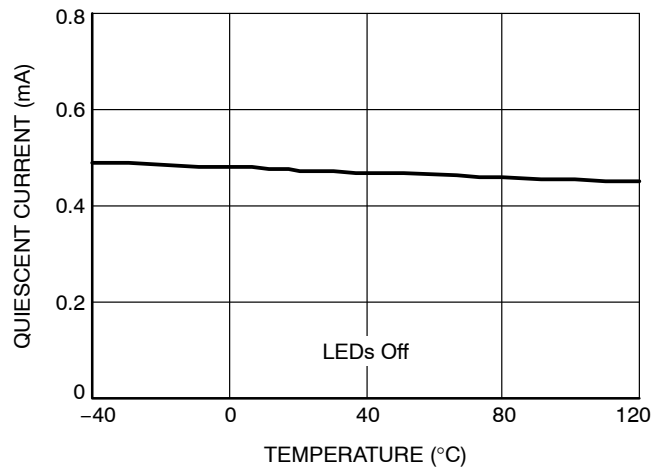

Figure 5. Quiescent Current vs. Temperature (1x Mode)

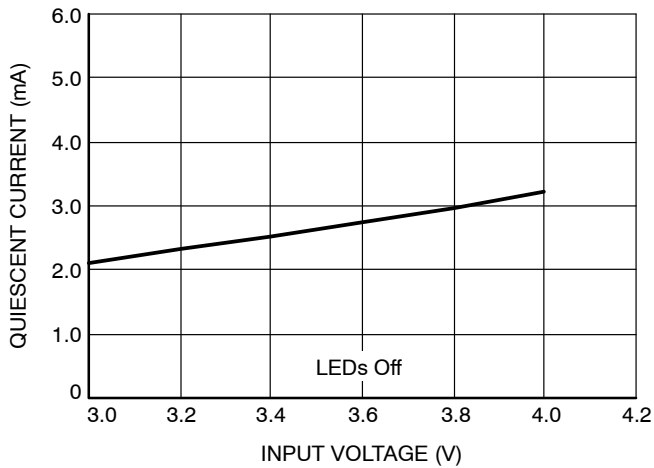

Figure 6. Quiescent Current vs. Input Voltage (1.5x Mode)

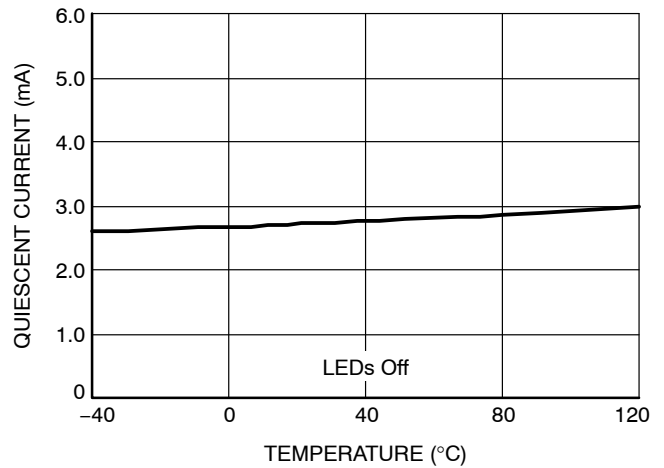

Figure 7. Quiescent Current vs. Temperature (1.5x Mode)

TYPICAL CHARACTERISTICS

(VIN = 3.6 V, IOUT = 60 mA (3 LEDs at 20 mA), C1 = C2 = CIN = COUT = 1 μF, TAMB = 25°C unless otherwise specified.)

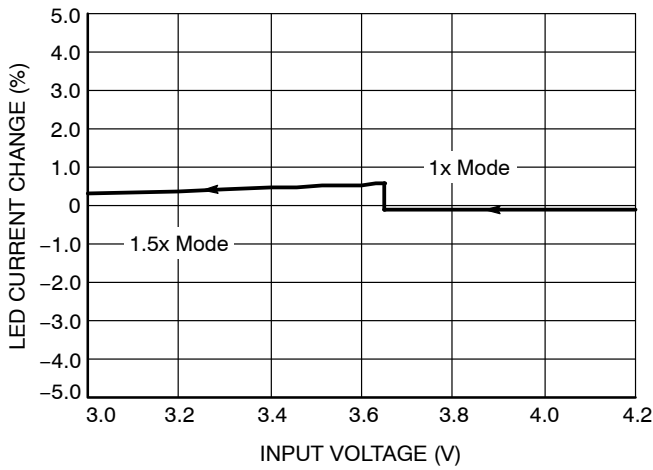

Figure 8. LED Current Change vs. Input Voltage

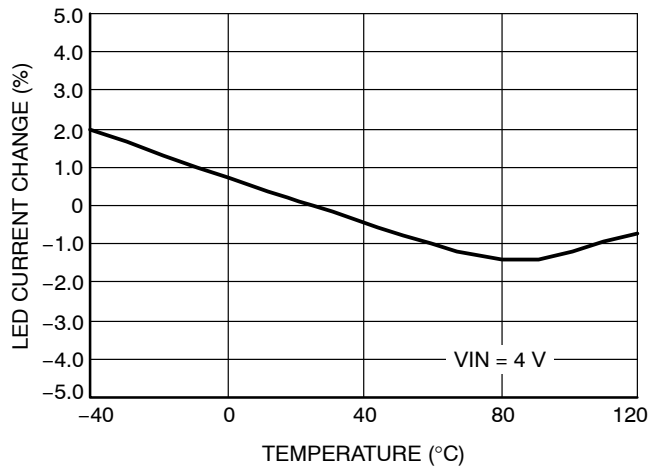

Figure 9. LED Current Change vs. Temperature

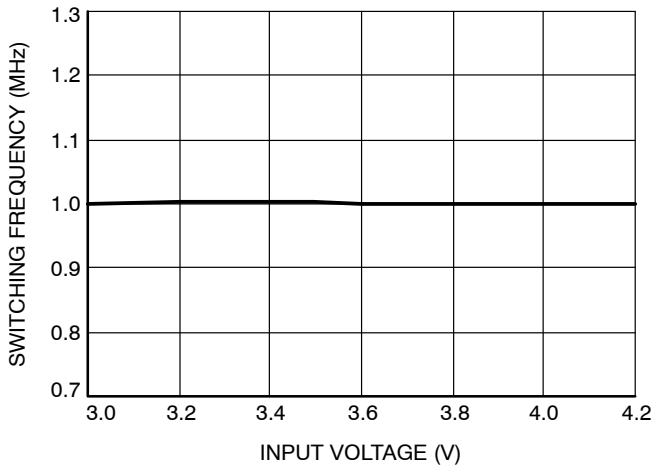

Figure 10. Switching Frequency vs. Input Voltage

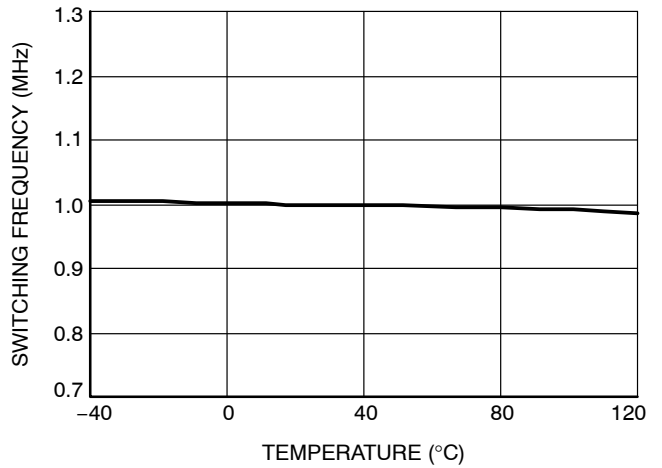

Figure 11. Switching Frequency vs. Temperature

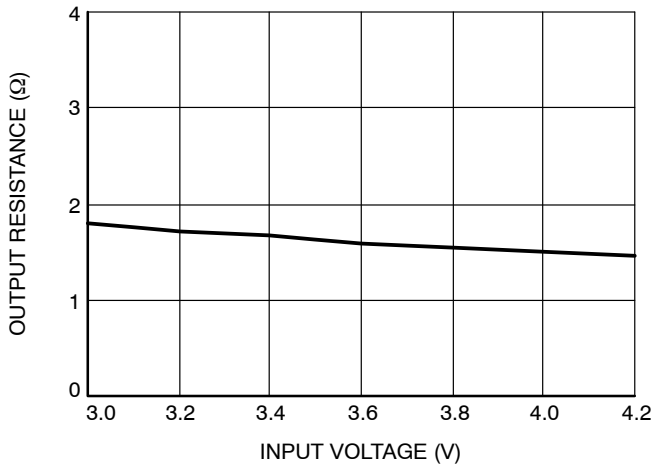

Figure 12. Output Resistance vs. Input Voltage (1x Mode)

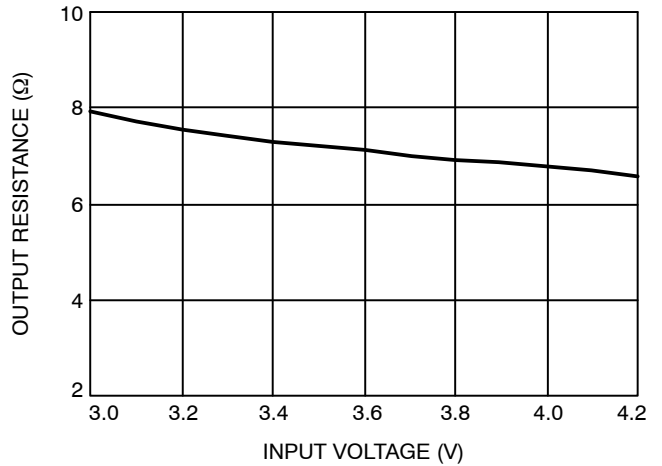

Figure 13. Output Resistance vs. Input Voltage (1.5x Mode)

CAT3603

TYPICAL CHARACTERISTICS

(VIN = 3.6 V, IOUT = 60 mA (3 LEDs at 20 mA), C1 = C2 = CIN = COUT = 1 μF, TAMB = 25°C unless otherwise specified.)

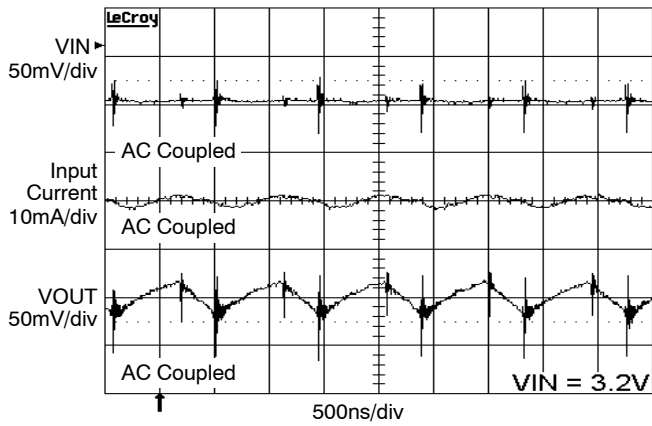

Figure 14. Switching Waveforms in 1.5x Mode

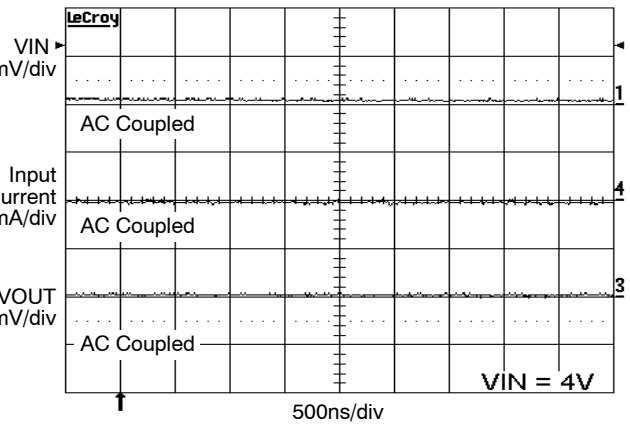

Figure 15. Operating Waveforms in 1x Mode

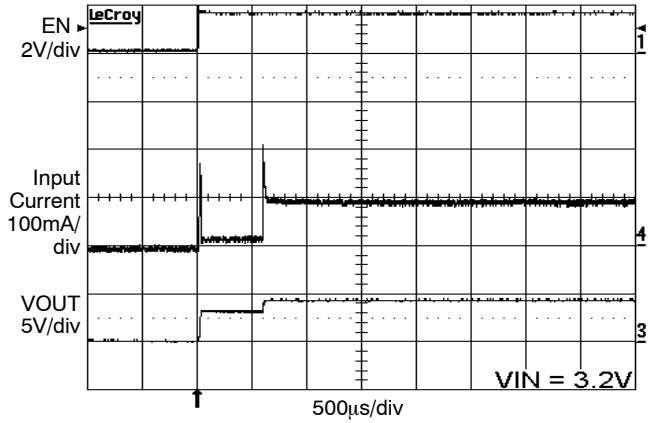

Figure 16. Power Up 3 LEDs at 20 mA, VIN = 3.2 V (1.5x Mode)

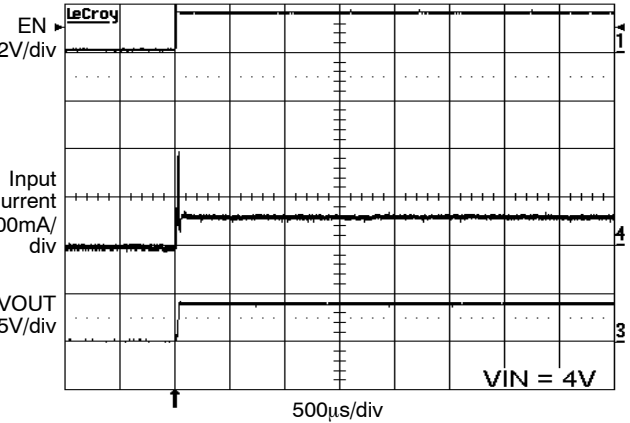

Figure 17. Power Up 3 LEDs at 20 mA, VIN = 4 V (1x Mode)

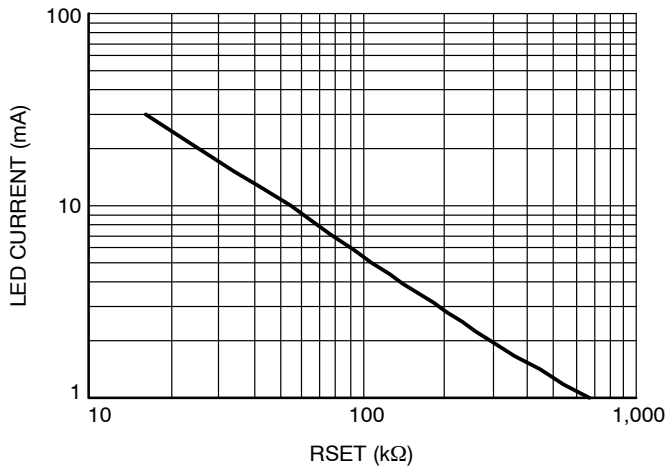

Figure 18. LED Current vs. RSET

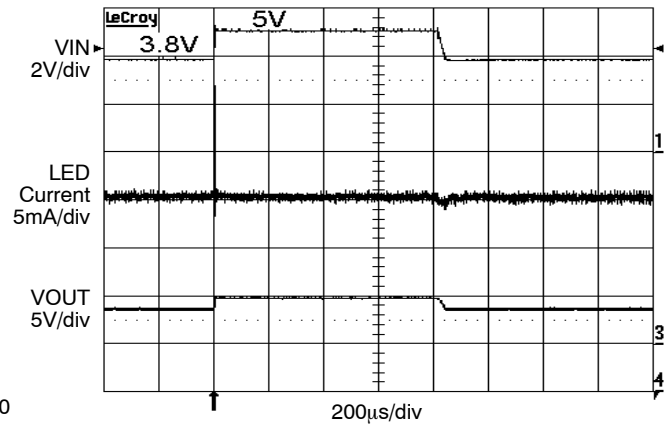

Figure 19. Line Transient Response in 1x Mode

CAT3603

TYPICAL CHARACTERISTICS

(VIN = 3.6 V, IOUT = 60 mA (3 LEDs at 20 mA), C1 = C2 = CIN = COUT = 1 μF, TAMB = 25°C unless otherwise specified.)

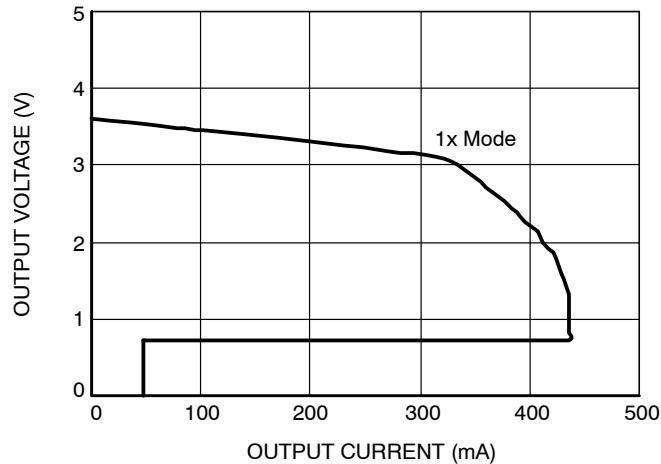

Figure 20. Foldback Current Limit

Table 4. PIN DESCRIPTION

Pin #	Name	Function
1	LED1	LED1 cathode terminal (if not used, connect to VOUT) (Note 2)
2	LED2	LED2 cathode terminal (if not used, connect to VOUT) (Note 2)
3	LED3	LED3 cathode terminal (if not used, connect to VOUT) (Note 2)
4	RSET	The LED output current is set by the current sourced out of the RSET pin
5	EN	Device enable (active high)
6	VOUT	Charge pump output connected to the LED anodes
7	VIN	Supply voltage
8	C1+	Bucket capacitor 1 terminal
9	C1-	Bucket capacitor 1 terminal
10	C2-	Bucket capacitor 2 terminal
11	C2+	Bucket capacitor 2 terminal
12	GND	Ground Reference
	TAB	Connect to GND on the PCB

2. LED1, LED2, LED3 pins should not be left floating. They should be connected to the LED cathode, or tied to VOUT pin if not used.

Pin Function

VIN is the supply pin for the charge pump. A small 1 μF ceramic bypass capacitor is required between the VIN pin and ground near the device. The operating input voltage range is from 3.0 V to 5.5 V.

EN is the enable control logic input for all LED channels. Guaranteed levels of logic high and logic low are set at 1.3 V and 0.4 V respectively.

RSET pin is regulated at 1.2 V. An external resistor RSET connected from the RSET pin to GND sets the LED current.

VOUT is the charge pump output that is connected to the LED anodes. A small 1 μF ceramic bypass capacitor is required between the VOUT pin and ground near the device.

GND is the ground reference for the charge pump. The pin must be connected to the ground plane on the PCB.

C1+, C1- are connected to each side of the 1 μF ceramic bucket capacitor C1.

C2+, C2- are connected to each side of the 1 μF ceramic bucket capacitor C2.

LED1 to LED3 provide the internal regulated current for each of the LED cathodes. These pins enter a high impedance, zero current state whenever the device is placed in shutdown mode. In applications using less than three LEDs, all unused channels should be wired directly to VOUT. This ensures the channel is automatically disabled dissipating less than 200 μA.

TAB is the exposed pad underneath the package. For best thermal performance, the tab should be soldered to the PCB and connected to the ground plane.

CAT3603

Block Diagram

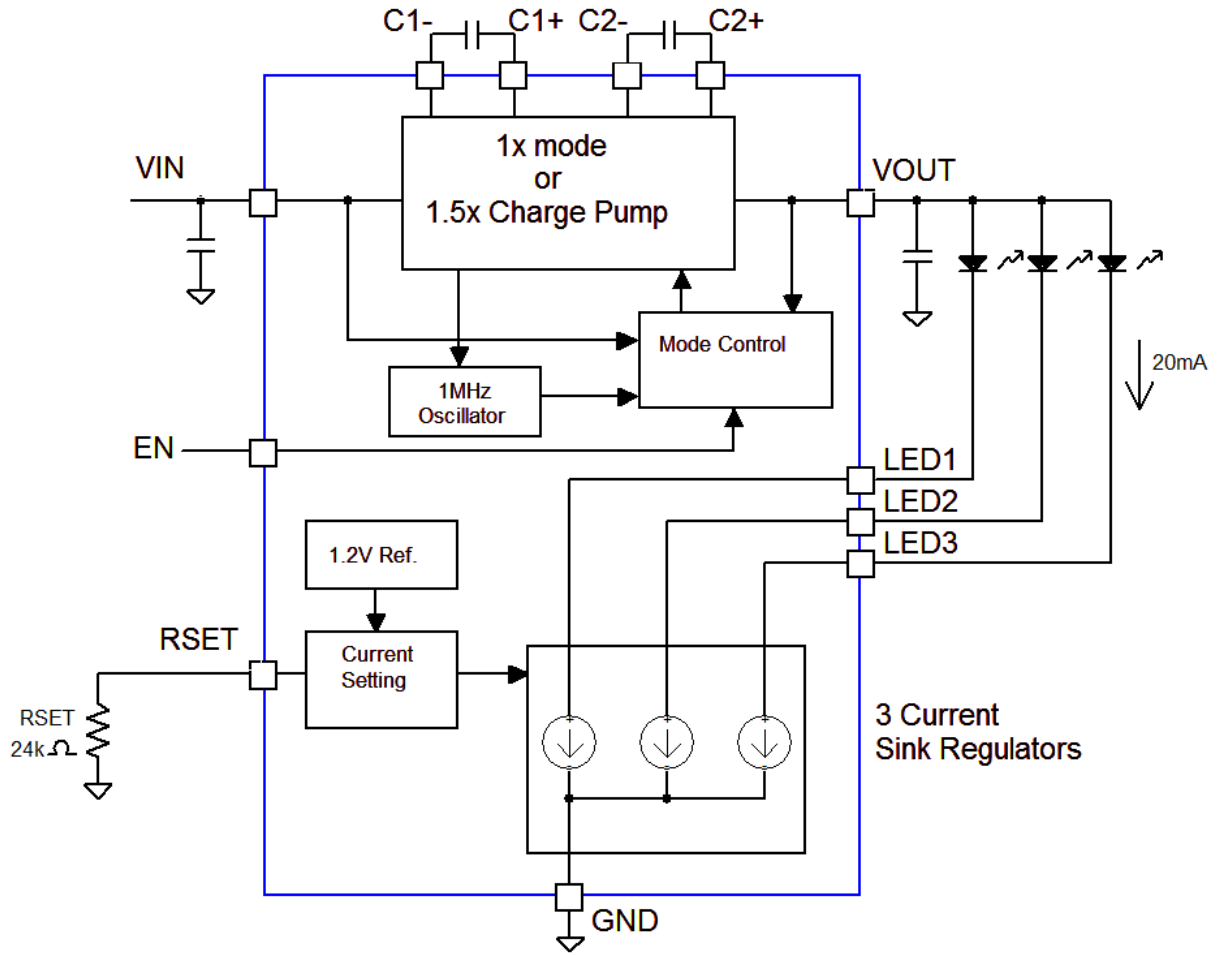

Figure 21. CAT3603 Functional Block Diagram

Basic Operation

At power-up, the CAT3603 starts operating in 1x mode where the output will be approximately equal to the input supply voltage (minus any internal voltage losses). If the output voltage is sufficient to regulate all LED currents, the device remains in 1x operating mode.

If the input voltage falls to a level where the regulated currents cannot be maintained, the device automatically switches into 1.5x mode.

In 1.5x mode, the output is approximately equal to 1.5 times the input supply voltage (minus any internal voltage losses), and high enough to achieve the nominal LED current.

The above sequence is reinitialized every time the chip is powered-up or is taken out of shutdown mode (via EN pin).

LED Current Setting

The LED current is set by the external resistor R_{SET} connected between the RSET pin and ground. Table 5 lists various LED currents and the associated R_{SET} resistor value for standard 1% precision surface mount resistors.

Table 5. RSET Resistor Selection

LED Current [mA]	R _{SET} [kΩ]
1	649
2	287
5	102
10	49.9
15	32.4
20	23.7
30	15.4

The unused LED channels must be disabled by connecting the respective LED pins to VOUT. A disabled channel sinks only 0.2 mA typical. When the following equation is true on any channel, the driver turns off the LED channel:

$$V_{OUT} - V_{LED} \leq 1 \text{ V (LED channel OFF)}$$

Note: The CAT3603 is designed to drive LEDs with forward voltage greater than 1 V and is not compatible with resistive loads less than 5 kΩ.

External Components

The driver requires a total of four external 1 μF ceramic capacitors: two for decoupling input and output, and two for the charge pump. Both capacitor types X5R and X7R are recommended for the LED driver application. In the 1.5x charge pump mode, the input current ripple is kept very low by design, and an input bypass capacitor of 1 μF is sufficient. In 1x mode, the device operating in linear mode does not introduce switching noise back onto the supply.

Recommended Layout

In 1.5x charge pump mode, the driver switches internally at a high frequency of 1 MHz. It is recommended to minimize trace length to all four capacitors. A ground plane should cover the area under the driver IC as well as the bypass capacitors. Short connection to ground on capacitors C_{IN} and C_{OUT} can be implemented with the use of multiple via. A copper area matching the TDFN exposed pad (GND) must be connected to the ground plane underneath. The use of multiple via improves the package heat dissipation.

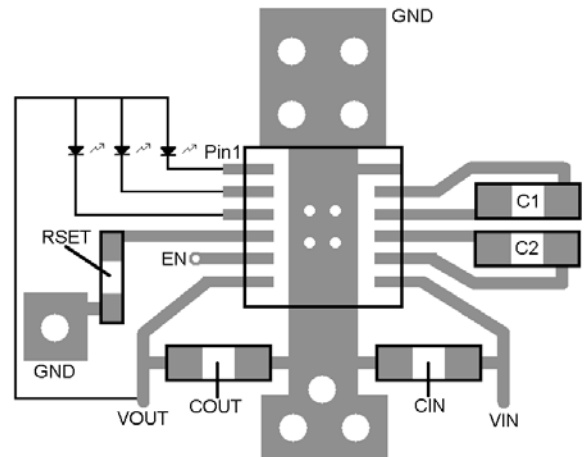
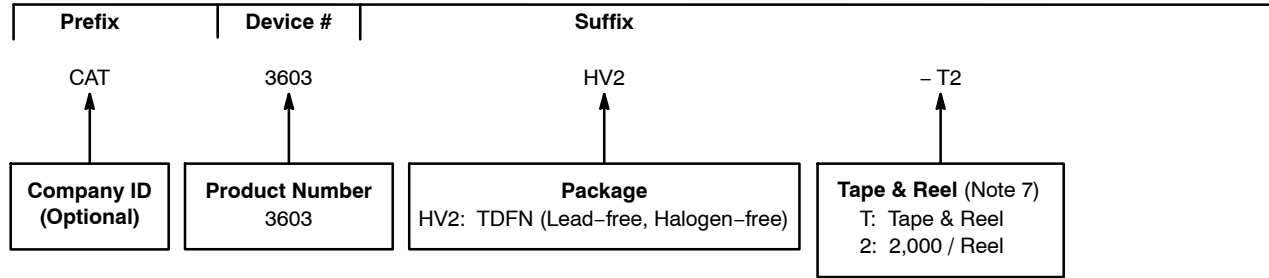

Figure 22. Recommended Layout

CAT3603

Example of Ordering Information (Notes 3, 4)



3. The device used in the above example is a CAT3603HV2-T2 (TDFN, Tape & Reel, 2,000/Reel).
4. All packages are RoHS-compliant (Lead-free, Halogen-free).
5. The standard lead finish is Matte-Tin.
6. For additional package and temperature options, please contact your nearest ON Semiconductor Sales office.
7. For information on tape and reel specifications, including part orientation and tape sizes, please refer to our Tape and Reel Packaging Specifications Brochure, BRD8011/D.



TDFN12, 3x3
CASE 511AN-01
ISSUE A

DATE 18 MAR 2009

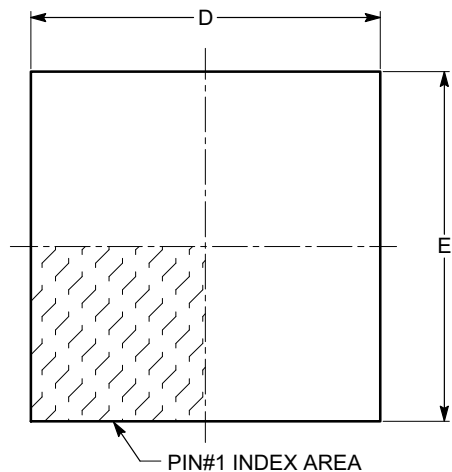

TOP VIEW

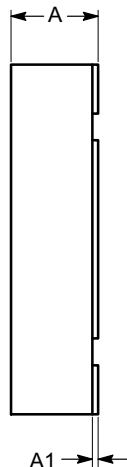

SIDE VIEW

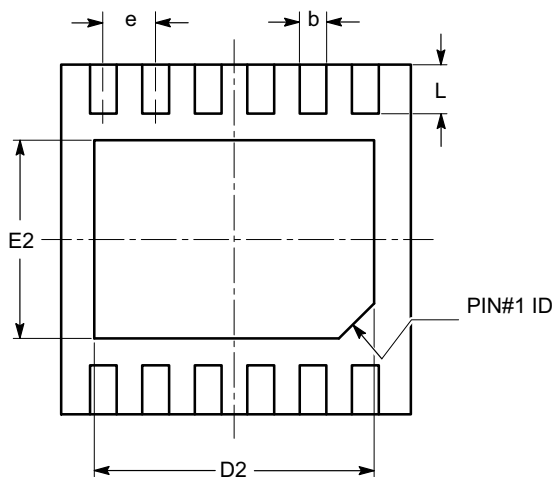

BOTTOM VIEW

SYMBOL	MIN	NOM	MAX
A	0.70	0.75	0.80
A1	0.00	0.02	0.05
A3	0.178	0.203	0.228
b	0.18	0.23	0.30
D	2.90	3.00	3.10
D2	2.30	2.40	2.50
E	2.90	3.00	3.10
E2	1.55	1.70	1.75
e	0.45 BSC		
L	0.30	0.40	0.50
M	0.25	0.30	0.35
N	0.60	0.70	0.80
P	2.70	3.00	3.10
R	2.25 TYP		

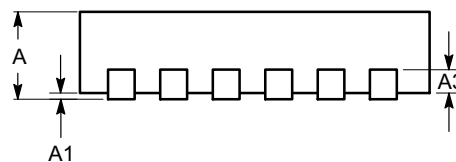

FRONT VIEW

RECOMMENDED LAND PATTERN

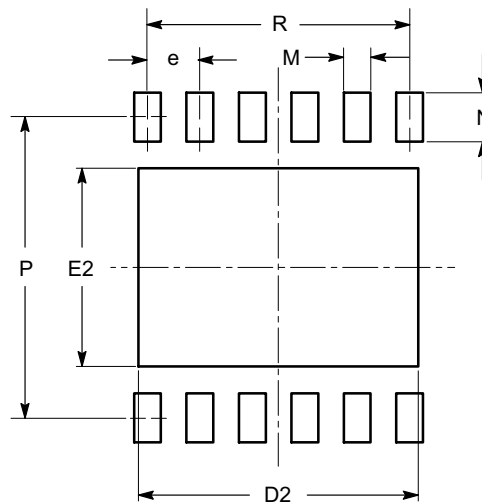

Notes:

- (1) All dimensions are in millimeters.
- (2) Complies with JEDEC MO-229.

DOCUMENT NUMBER:	98AON34357E	Electronic versions are uncontrolled except when accessed directly from the Document Repository. Printed versions are uncontrolled except when stamped "CONTROLLED COPY" in red.
DESCRIPTION:	TDFN12, 3X3	PAGE 1 OF 1

ON Semiconductor and are trademarks of Semiconductor Components Industries, LLC dba ON Semiconductor or its subsidiaries in the United States and/or other countries. ON Semiconductor reserves the right to make changes without further notice to any products herein. ON Semiconductor makes no warranty, representation or guarantee regarding the suitability of its products for any particular purpose, nor does ON Semiconductor assume any liability arising out of the application or use of any product or circuit, and specifically disclaims any and all liability, including without limitation special, consequential or incidental damages. ON Semiconductor does not convey any license under its patent rights nor the rights of others.

onsemi, **Onsemi**, and other names, marks, and brands are registered and/or common law trademarks of Semiconductor Components Industries, LLC dba "**onsemi**" or its affiliates and/or subsidiaries in the United States and/or other countries. **onsemi** owns the rights to a number of patents, trademarks, copyrights, trade secrets, and other intellectual property. A listing of **onsemi**'s product/patent coverage may be accessed at www.onsemi.com/site/pdf/Patent-Marking.pdf. **onsemi** reserves the right to make changes at any time to any products or information herein, without notice. The information herein is provided "as-is" and **onsemi** makes no warranty, representation or guarantee regarding the accuracy of the information, product features, availability, functionality, or suitability of its products for any particular purpose, nor does **onsemi** assume any liability arising out of the application or use of any product or circuit, and specifically disclaims any and all liability, including without limitation special, consequential or incidental damages. Buyer is responsible for its products and applications using **onsemi** products, including compliance with all laws, regulations and safety requirements or standards, regardless of any support or applications information provided by **onsemi**. "Typical" parameters which may be provided in **onsemi** data sheets and/or specifications can and do vary in different applications and actual performance may vary over time. All operating parameters, including "Typicals" must be validated for each customer application by customer's technical experts. **onsemi** does not convey any license under any of its intellectual property rights nor the rights of others. **onsemi** products are not designed, intended, or authorized for use as a critical component in life support systems or any FDA Class 3 medical devices or medical devices with a same or similar classification in a foreign jurisdiction or any devices intended for implantation in the human body. Should Buyer purchase or use **onsemi** products for any such unintended or unauthorized application, Buyer shall indemnify and hold **onsemi** and its officers, employees, subsidiaries, affiliates, and distributors harmless against all claims, costs, damages, and expenses, and reasonable attorney fees arising out of, directly or indirectly, any claim of personal injury or death associated with such unintended or unauthorized use, even if such claim alleges that **onsemi** was negligent regarding the design or manufacture of the part. **onsemi** is an Equal Opportunity/Affirmative Action Employer. This literature is subject to all applicable copyright laws and is not for resale in any manner.

PUBLICATION ORDERING INFORMATION

LITERATURE FULFILLMENT:

Email Requests to: orderlit@onsemi.com

onsemi Website: www.onsemi.com

TECHNICAL SUPPORT

North American Technical Support:
Voice Mail: 1 800-282-9855 Toll Free USA/Canada
Phone: 011 421 33 790 2910

Europe, Middle East and Africa Technical Support:

Phone: 00421 33 790 2910

For additional information, please contact your local Sales Representative