

# Dual General Purpose Transistors

## NPN/PNP Duals (Complementary)

### BC846BPDW1, BC847BPDW1, BC848CPDW1 Series

These transistors are designed for general purpose amplifier applications. They are housed in the SOT-363/SC-88 which is designed for low power surface mount applications.

#### Features

- S Prefix for Automotive and Other Applications Requiring Unique Site and Control Change Requirements; AEC-Q101 Qualified and PPAP Capable
- These Devices are Pb-Free, Halogen Free/BFR Free and are RoHS Compliant

#### MAXIMUM RATINGS – NPN

Rating	Symbol	Value	Unit
Collector-Emitter Voltage BC846 BC847 BC848	$V_{CEO}$	65 45 30	V
Collector-Base Voltage BC846 BC847 BC848	$V_{CBO}$	80 50 30	V
Emitter-Base Voltage	$V_{EBO}$	6.0	V
Collector Current – Continuous	$I_C$	100	mAdc
Collector Current – Peak	$I_{CM}$	200	mAdc

#### MAXIMUM RATINGS – PNP

Rating	Symbol	Value	Unit
Collector-Emitter Voltage BC846 BC847 BC848	$V_{CEO}$	-65 -45 -30	V
Collector-Base Voltage BC846 BC847 BC848	$V_{CBO}$	-80 -50 -30	V
Emitter-Base Voltage	$V_{EBO}$	-6.0	V
Collector Current – Continuous	$I_C$	-100	mAdc
Collector Current – Peak	$I_{CM}$	-200	mAdc

Stresses exceeding those listed in the Maximum Ratings table may damage the device. If any of these limits are exceeded, device functionality should not be assumed, damage may occur and reliability may be affected.

SOT-363  
CASE 419B  
STYLE 1

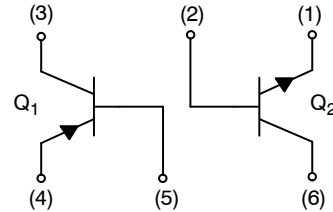

#### MARKING DIAGRAM

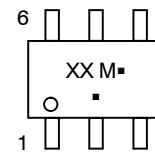

XX = Device Code  
M = Date Code  
▪ = Pb-Free Package

(Note: Microdot may be in either location)

#### ORDERING INFORMATION

Device	Mark	Package	Shipping <sup>†</sup>
BC846BPDW1T1G, SBC846BPDW1T1G	BB	SOT-363 (Pb-Free)	3,000 / Tape & Reel
SBC846BPDW1T2G	BB	SOT-363 (Pb-Free)	3,000 / Tape & Reel
SBC846BPDW1T3G	BB	SOT-363 (Pb-Free)	10,000 / Tape & Reel
BC847BPDW1T1G	BF	SOT-363 (Pb-Free)	3,000 / Tape & Reel
SBC847BPDW1T1G	BF	SOT-363 (Pb-Free)	3,000 / Tape & Reel
SBC847BPDW1T3G	BF	SOT-363 (Pb-Free)	10,000 / Tape & Reel
BC847BPDW1T2G	BF	SOT-363 (Pb-Free)	3,000 / Tape & Reel
BC848CPDW1T1G	BL	SOT-363 (Pb-Free)	3,000 / Tape & Reel

<sup>†</sup>For information on tape and reel specifications, including part orientation and tape sizes, please refer to our Tape and Reel Packaging Specification Brochure, BRD8011/D.

# BC846BPDW1, BC847BPDW1, BC848CPDW1 Series

## THERMAL CHARACTERISTICS

Characteristic	Symbol	Max	Unit
Total Device Dissipation Per Device FR-5 Board (Note 1) $T_A = 25^\circ\text{C}$ Derate above $25^\circ\text{C}$	$P_D$	380 250 3.0	mW mW/ $^\circ\text{C}$ mW/ $^\circ\text{C}$
Thermal Resistance, Junction-to-Ambient	$R_{\theta JA}$	328	$^\circ\text{C/W}$
Junction and Storage Temperature	$T_J, T_{stg}$	-55 to +150	$^\circ\text{C}$

1. FR-5 = 1.0 x 0.75 x 0.062 in.

## ELECTRICAL CHARACTERISTICS (NPN) ( $T_A = 25^\circ\text{C}$ unless otherwise noted)

Characteristic	Symbol	Min	Typ	Max	Unit
----------------	--------	-----	-----	-----	------

### OFF CHARACTERISTICS

Collector - Emitter Breakdown Voltage ( $I_C = 10\text{ mA}$ ) BC846 BC847 BC848	$V_{(BR)CEO}$	65 45 30	- - -	- - -	V
Collector - Emitter Breakdown Voltage ( $I_C = 10\ \mu\text{A}, V_{EB} = 0$ ) BC846 BC847B BC848	$V_{(BR)CES}$	80 50 30	- - -	- - -	V
Collector - Base Breakdown Voltage ( $I_C = 10\ \mu\text{A}$ ) BC846 BC847 BC848	$V_{(BR)CBO}$	80 50 30	- - -	- - -	V
Emitter - Base Breakdown Voltage ( $I_E = 1.0\ \mu\text{A}$ ) BC846 BC847 BC848	$V_{(BR)EBO}$	6.0 6.0 6.0	- - -	- - -	V
Collector Cutoff Current ( $V_{CB} = 30\text{ V}$ ) ( $V_{CB} = 30\text{ V}, T_A = 150^\circ\text{C}$ )	$I_{CBO}$	- -	- -	15 5.0	nA $\mu\text{A}$

### ON CHARACTERISTICS

DC Current Gain ( $I_C = 10\ \mu\text{A}, V_{CE} = 5.0\text{ V}$ ) BC846B, BC847B BC848C ( $I_C = 2.0\text{ mA}, V_{CE} = 5.0\text{ V}$ ) BC846B, BC847B BC848C	$h_{FE}$	- - 200 420	150 270 290 520	- - 475 800	-
Collector - Emitter Saturation Voltage ( $I_C = 10\text{ mA}, I_B = 0.5\text{ mA}$ ) All devices except SBC847BPDW1T1G SBC847BPDW1T1G only ( $I_C = 100\text{ mA}, I_B = 5.0\text{ mA}$ ) All devices ( $I_C = 2\text{ mA}, I_B = 0.5\text{ mA}$ ) SBC847BPDW1T1G only	$V_{CE(sat)}$	- - - -	- - - 0.024	0.25 0.1 0.6 -	V
Base - Emitter Saturation Voltage ( $I_C = 10\text{ mA}, I_B = 0.5\text{ mA}$ ) ( $I_C = 100\text{ mA}, I_B = 5.0\text{ mA}$ )	$V_{BE(sat)}$	- -	0.7 0.9	- -	V
Base - Emitter Voltage ( $I_C = 2.0\text{ mA}, V_{CE} = 5.0\text{ V}$ ) ( $I_C = 10\text{ mA}, V_{CE} = 5.0\text{ V}$ )	$V_{BE(on)}$	580 -	660 -	700 770	mV

### SMALL-SIGNAL CHARACTERISTICS

Current - Gain - Bandwidth Product ( $I_C = 10\text{ mA}, V_{CE} = 5.0\text{ Vdc}, f = 100\text{ MHz}$ )	$f_T$	100	-	-	MHz
Output Capacitance ( $V_{CB} = 10\text{ V}, f = 1.0\text{ MHz}$ )	$C_{obo}$	-	-	4.5	pF
Noise Figure ( $I_C = 0.2\text{ mA}, V_{CE} = 5.0\text{ Vdc}, R_S = 2.0\text{ k}\Omega, f = 1.0\text{ kHz}, BW = 200\text{ Hz}$ )	NF	-	-	10	dB

## BC846BPDW1, BC847BPDW1, BC848CPDW1 Series

### ELECTRICAL CHARACTERISTICS (PNP) ( $T_A = 25^\circ\text{C}$ unless otherwise noted)

Characteristic	Symbol	Min	Typ	Max	Unit
<b>OFF CHARACTERISTICS</b>					
Collector – Emitter Breakdown Voltage ( $I_C = -10\text{ mA}$ ) BC846 BC847 BC848	$V_{(BR)CEO}$	-65 -45 -30	-	-	V
Collector – Emitter Breakdown Voltage ( $I_C = -10\ \mu\text{A}$ , $V_{EB} = 0$ ) BC846 BC847 BC848	$V_{(BR)CES}$	-80 -50 -30	-	-	V
Collector – Base Breakdown Voltage ( $I_C = -10\ \mu\text{A}$ ) BC846 BC847 BC848	$V_{(BR)CBO}$	-80 -50 -30	-	-	V
Emitter – Base Breakdown Voltage ( $I_E = -1.0\ \mu\text{A}$ ) BC846 BC847 BC848	$V_{(BR)EBO}$	-6.0 -6.0 -6.0	-	-	V
Collector Cutoff Current ( $V_{CB} = -30\text{ V}$ ) ( $V_{CB} = -30\text{ V}$ , $T_A = 150^\circ\text{C}$ )	$I_{CBO}$	- -	- -	-15 -4.0	nA $\mu\text{A}$
<b>ON CHARACTERISTICS</b>					
DC Current Gain ( $I_C = -10\ \mu\text{A}$ , $V_{CE} = -5.0\text{ V}$ ) BC846B, BC847B BC848C ( $I_C = -2.0\text{ mA}$ , $V_{CE} = -5.0\text{ V}$ ) BC846B, BC847B BC848C	$h_{FE}$	- - 200 420	150 270 290 520	- - 475 800	-
Collector – Emitter Saturation Voltage ( $I_C = -10\text{ mA}$ , $I_B = -0.5\text{ mA}$ ) All devices except SBC847BPDW1T1G SBC847BPDW1T1G only ( $I_C = -100\text{ mA}$ , $I_B = -5.0\text{ mA}$ ) All devices ( $I_C = -2\text{ mA}$ , $I_B = -0.5\text{ mA}$ ) SBC847BPDW1T1G only	$V_{CE(sat)}$	- - - -	- - - -0.024	-0.3 -0.1 -0.65 -	V
Base – Emitter Saturation Voltage ( $I_C = -10\text{ mA}$ , $I_B = -0.5\text{ mA}$ ) ( $I_C = -100\text{ mA}$ , $I_B = -5.0\text{ mA}$ )	$V_{BE(sat)}$	- -	-0.7 -0.9	- -	V
Base – Emitter On Voltage ( $I_C = -2.0\text{ mA}$ , $V_{CE} = -5.0\text{ V}$ ) ( $I_C = -10\text{ mA}$ , $V_{CE} = -5.0\text{ V}$ )	$V_{BE(on)}$	-0.6 -	- -	-0.75 -0.82	V
<b>SMALL – SIGNAL CHARACTERISTICS</b>					
Current – Gain – Bandwidth Product ( $I_C = -10\text{ mA}$ , $V_{CE} = -5.0\text{ Vdc}$ , $f = 100\text{ MHz}$ )	$f_T$	100	-	-	MHz
Output Capacitance ( $V_{CB} = -10\text{ V}$ , $f = 1.0\text{ MHz}$ )	$C_{ob}$	-	-	4.5	pF
Noise Figure ( $I_C = -0.2\text{ mA}$ , $V_{CE} = -5.0\text{ Vdc}$ , $R_S = 2.0\text{ k}\Omega$ , $f = 1.0\text{ kHz}$ , $BW = 200\text{ Hz}$ )	NF	-	-	10	dB

TYPICAL NPN CHARACTERISTICS – BC846

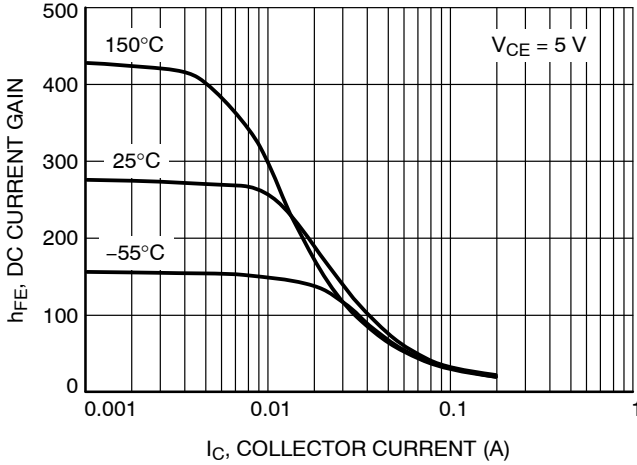

Figure 1. DC Current Gain vs. Collector Current

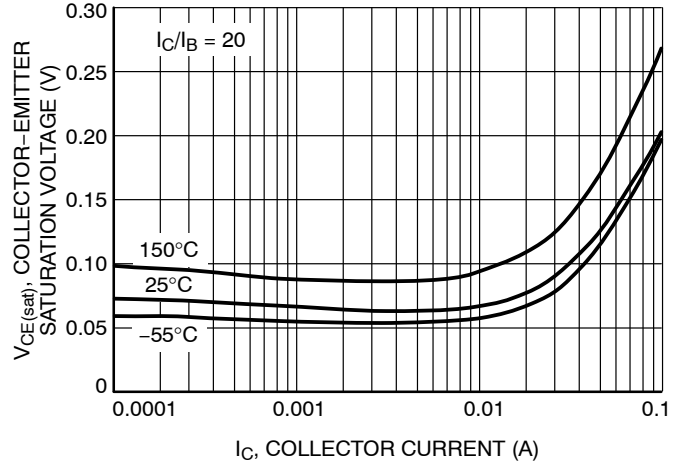

Figure 2. Collector Emitter Saturation Voltage vs. Collector Current

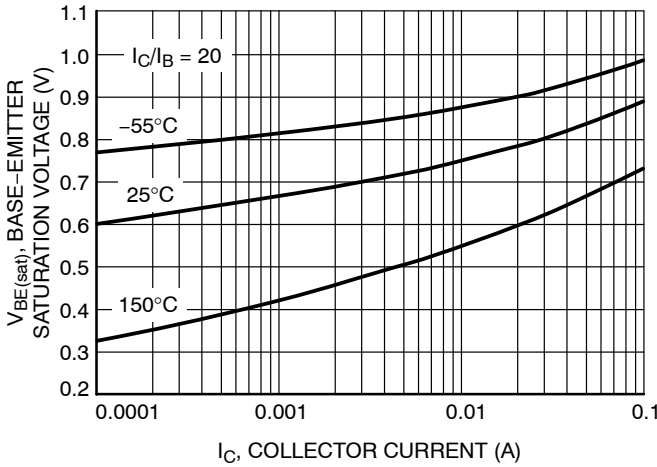

Figure 3. Base Emitter Saturation Voltage vs. Collector Current

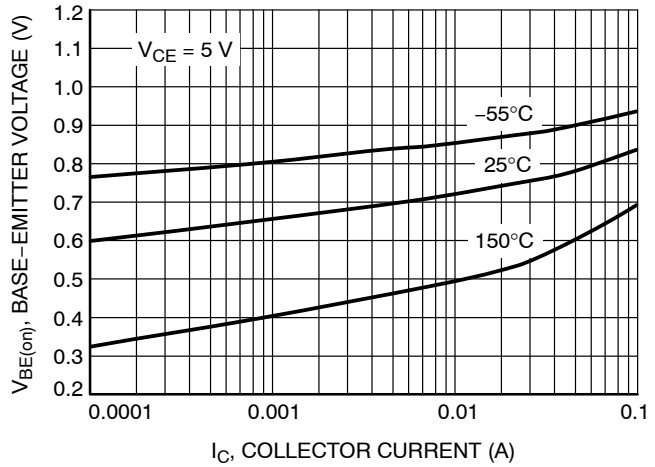

Figure 4. Base Emitter Voltage vs. Collector Current

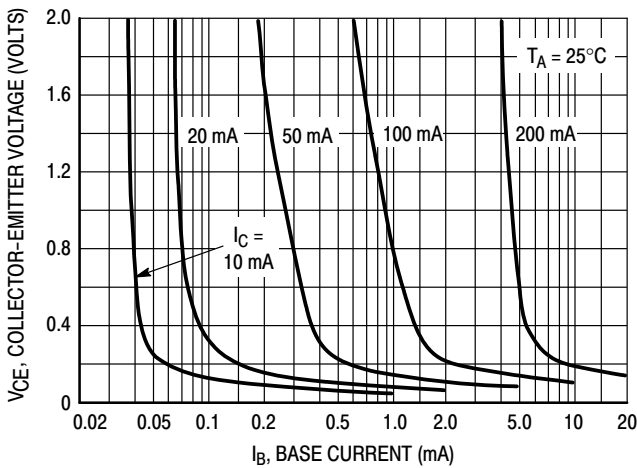

Figure 5. Collector Saturation Region

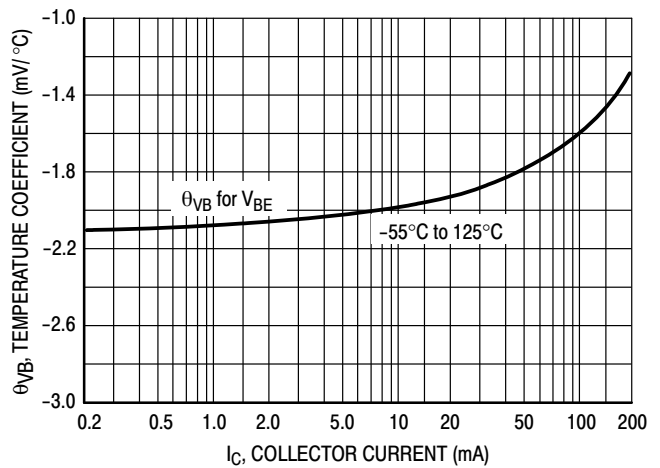

Figure 6. Base-Emitter Temperature Coefficient

# BC846BPDW1, BC847BPDW1, BC848CPDW1 Series

## TYPICAL NPN CHARACTERISTICS – BC846

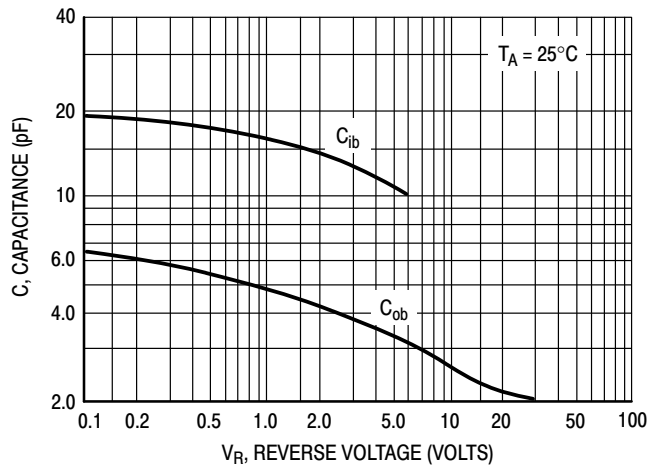

Figure 7. Capacitance

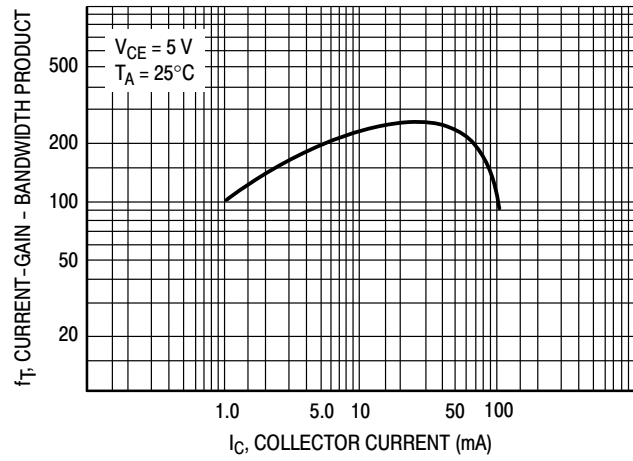

Figure 8. Current-Gain - Bandwidth Product

TYPICAL PNP CHARACTERISTICS — BC846

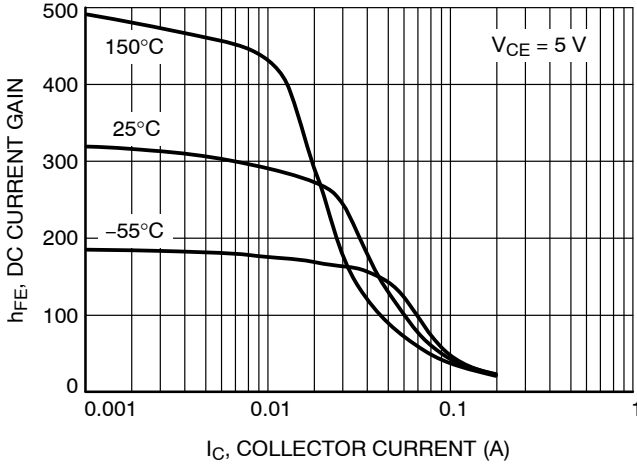

Figure 9. DC Current Gain vs. Collector Current

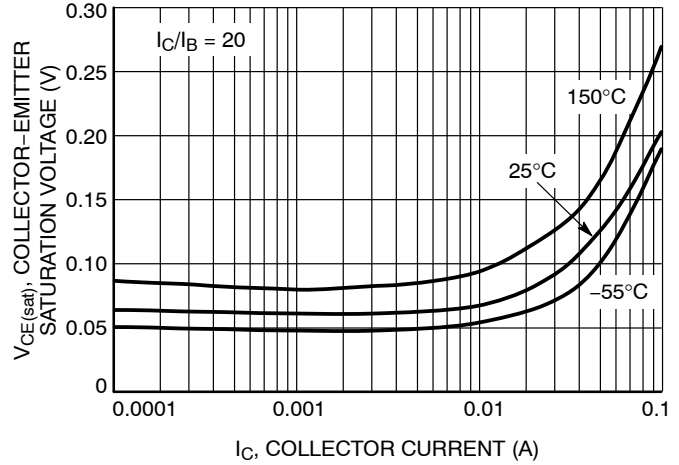

Figure 10. Collector Emitter Saturation Voltage vs. Collector Current

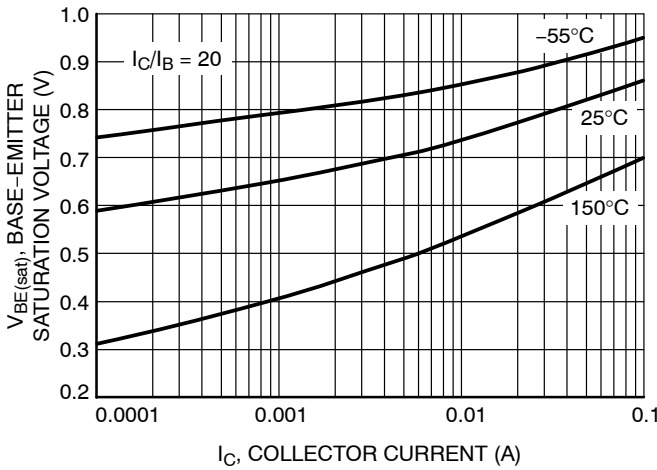

Figure 11. Base Emitter Saturation Voltage vs. Collector Current

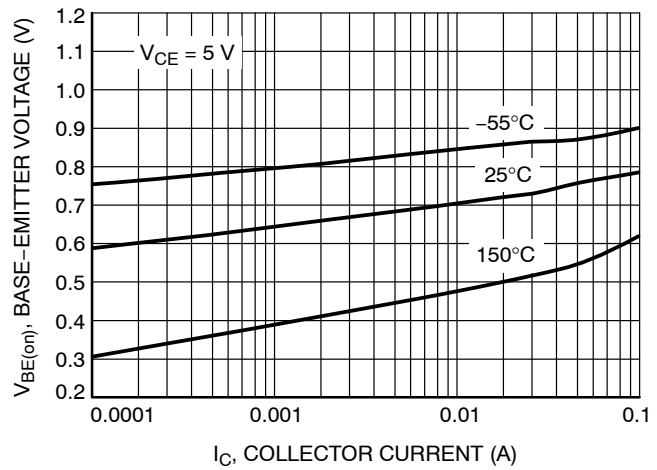

Figure 12. Base Emitter Voltage vs. Collector Current

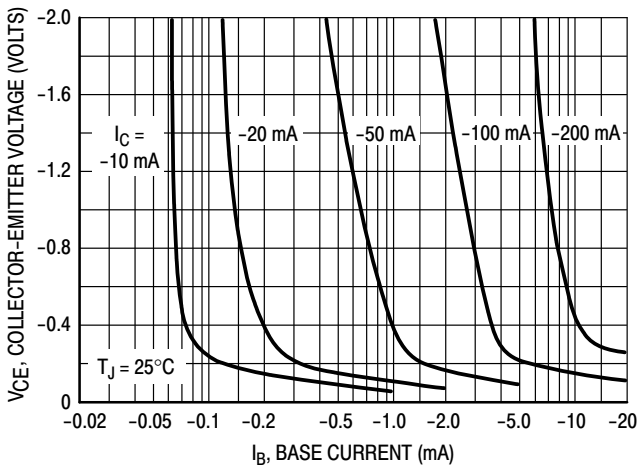

Figure 13. Collector Saturation Region

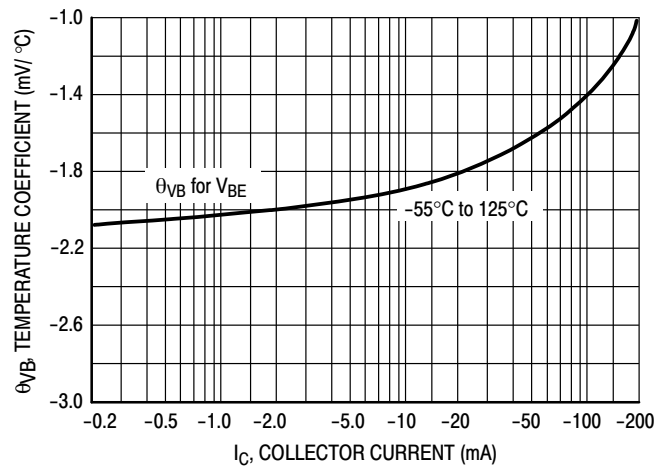

Figure 14. Base-Emitter Temperature Coefficient

# BC846BPDW1, BC847BPDW1, BC848CPDW1 Series

## TYPICAL PNP CHARACTERISTICS — BC846

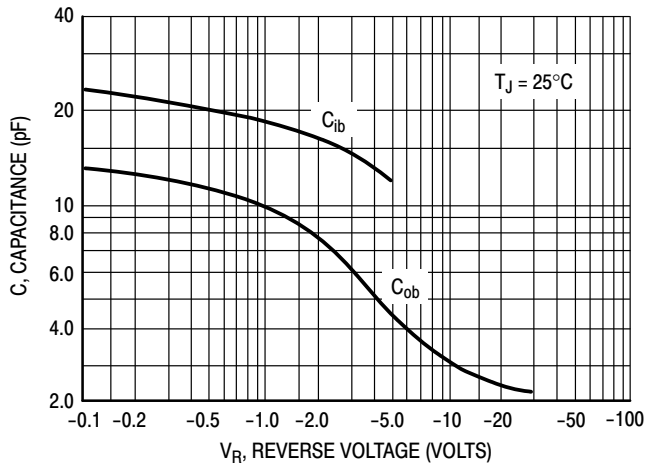

Figure 15. Capacitance

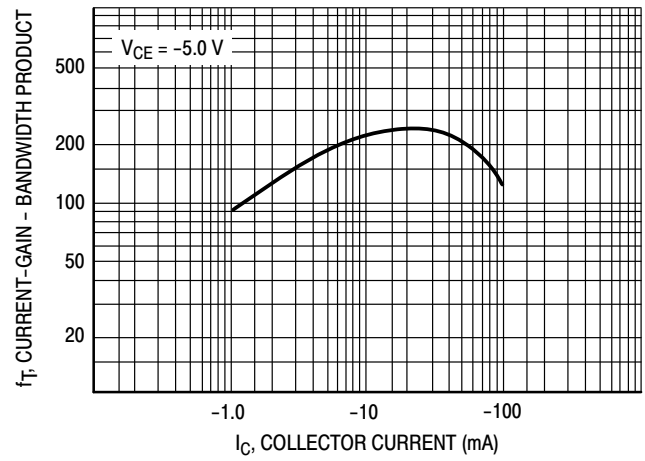
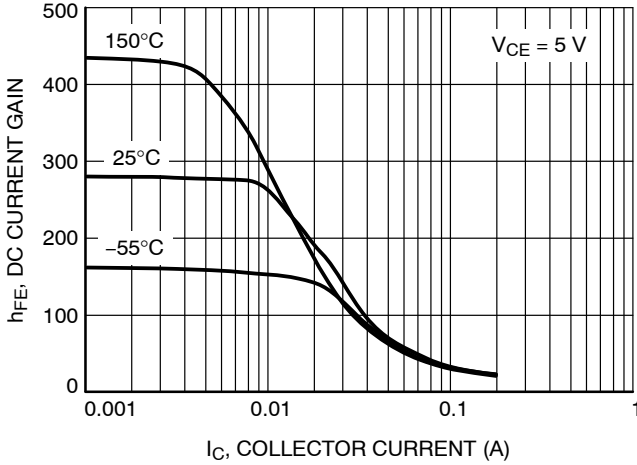

Figure 16. Current-Gain - Bandwidth Product

# BC846BPDW1, BC847BPDW1, BC848CPDW1 Series

## TYPICAL NPN CHARACTERISTICS – BC847



**Figure 17. DC Current Gain vs. Collector Current**

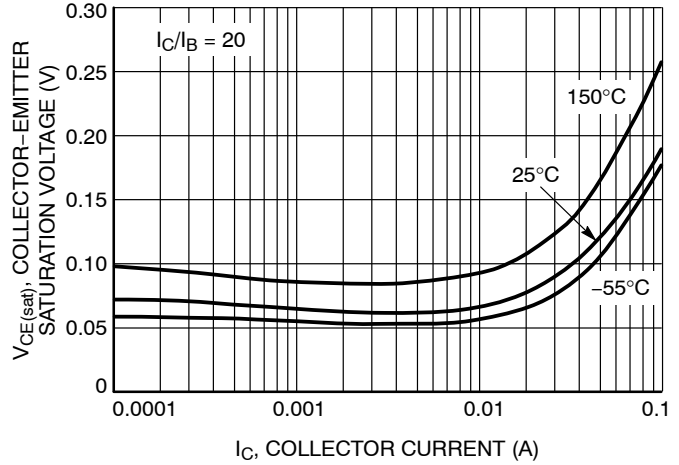

**Figure 18. Collector Emitter Saturation Voltage vs. Collector Current**

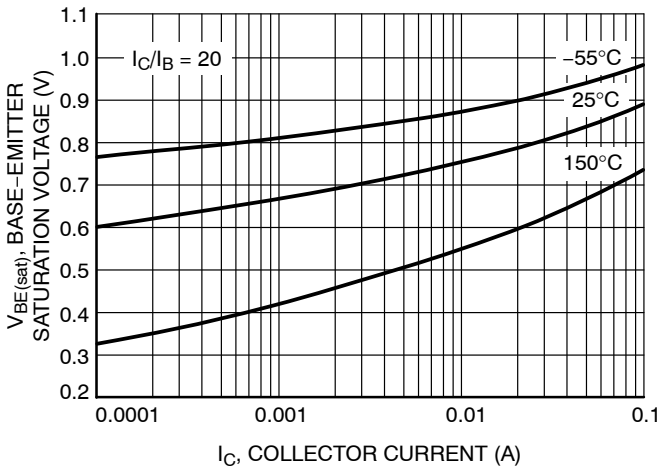

**Figure 19. Base Emitter Saturation Voltage vs. Collector Current**

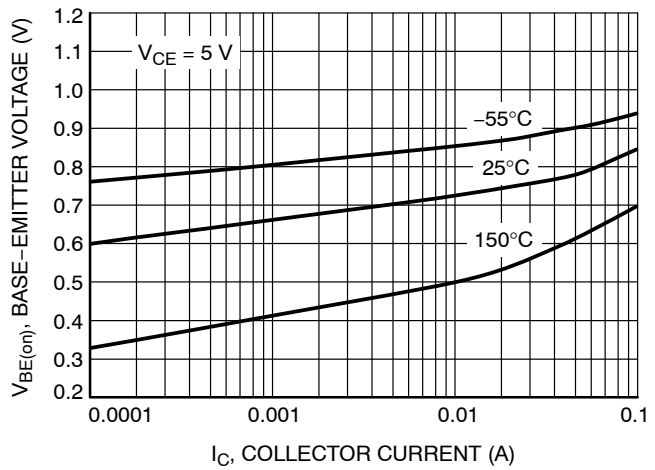

**Figure 20. Base Emitter Voltage vs. Collector Current**

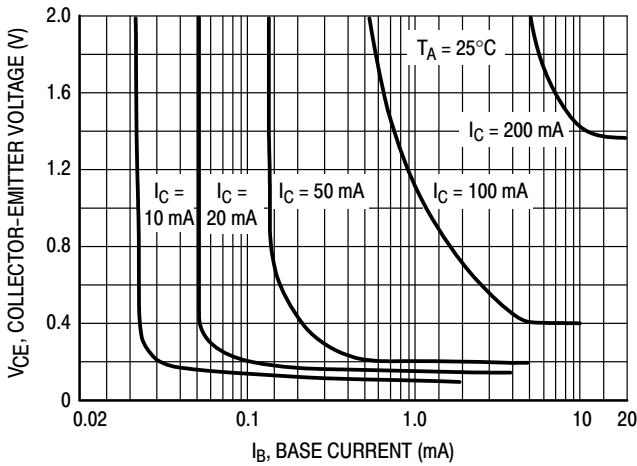

**Figure 21. Collector Saturation Region**

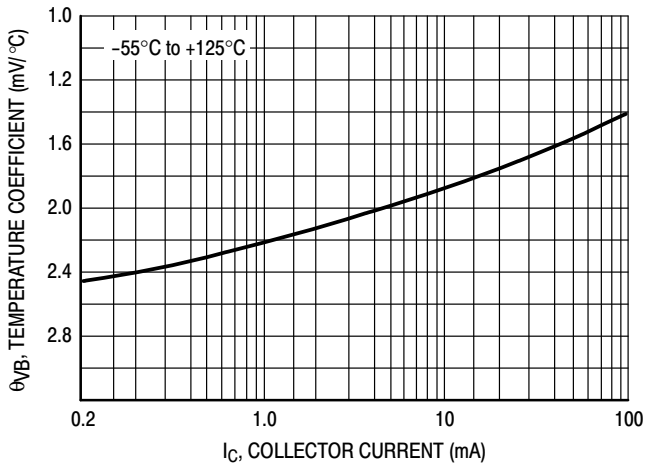

**Figure 22. Base-Emitter Temperature Coefficient**



# BC846BPDW1, BC847BPDW1, BC848CPDW1 Series

## TYPICAL NPN CHARACTERISTICS – BC847

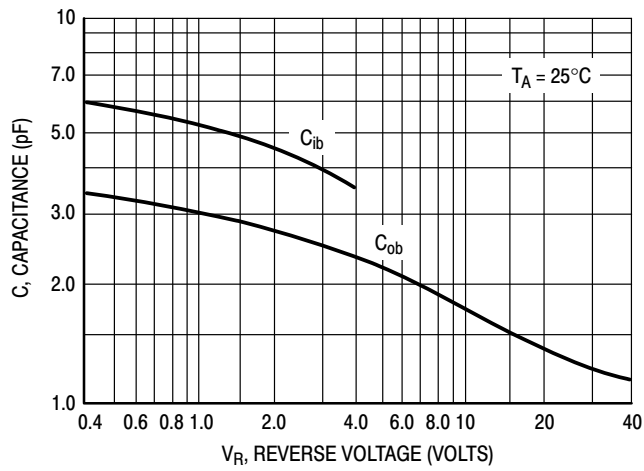

Figure 23. Capacitances

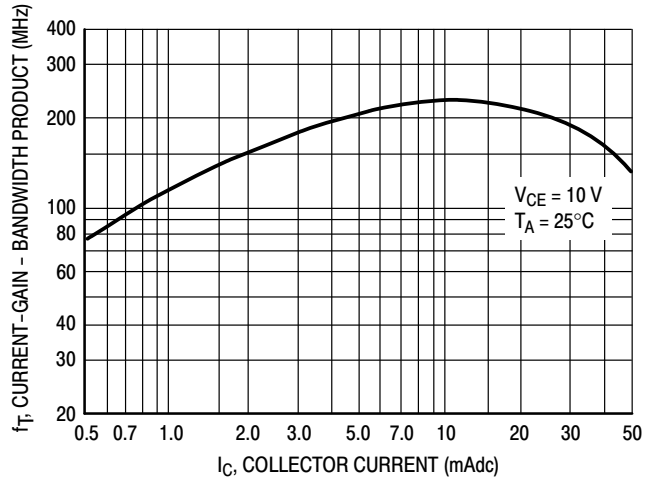
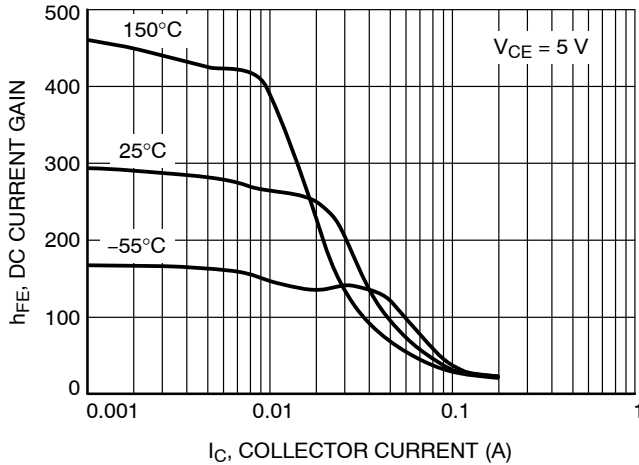

Figure 24. Current-Gain - Bandwidth Product

# BC846BPDW1, BC847BPDW1, BC848CPDW1 Series

## TYPICAL PNP CHARACTERISTICS – BC847



**Figure 25. DC Current Gain vs. Collector Current**

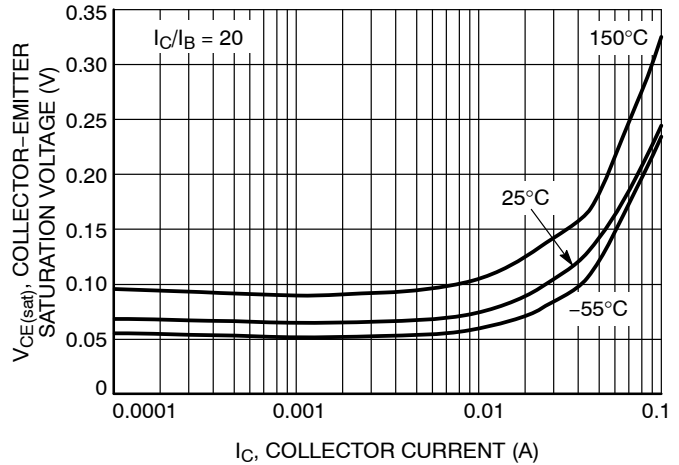

**Figure 26. Collector Emitter Saturation Voltage vs. Collector Current**

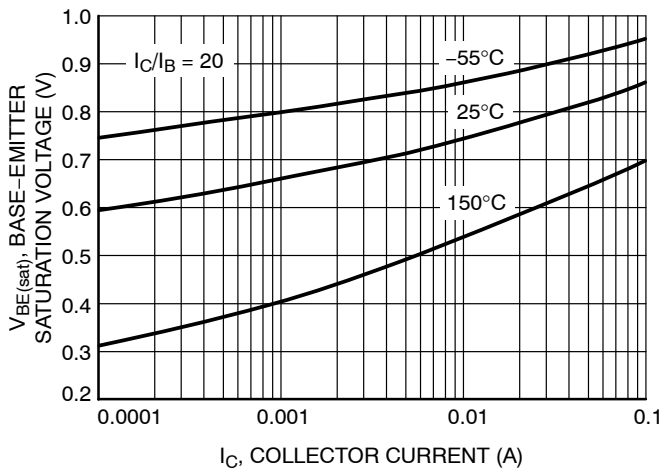

**Figure 27. Base Emitter Saturation Voltage vs. Collector Current**

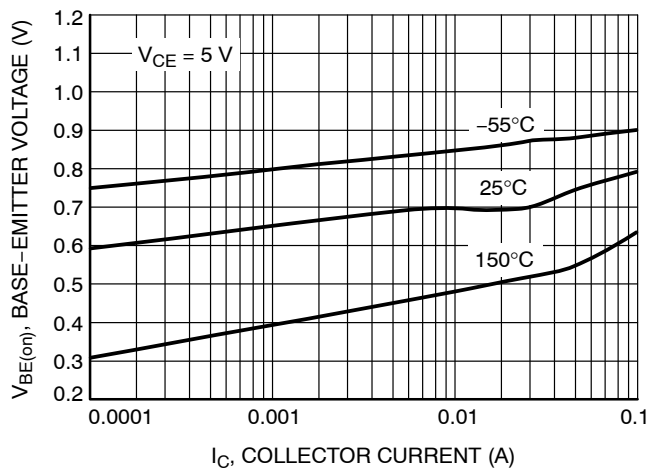

**Figure 28. Base Emitter Voltage vs. Collector Current**

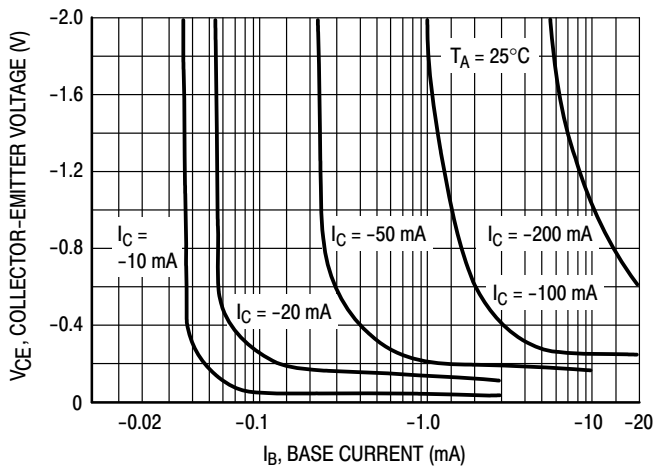

**Figure 29. Collector Saturation Region**

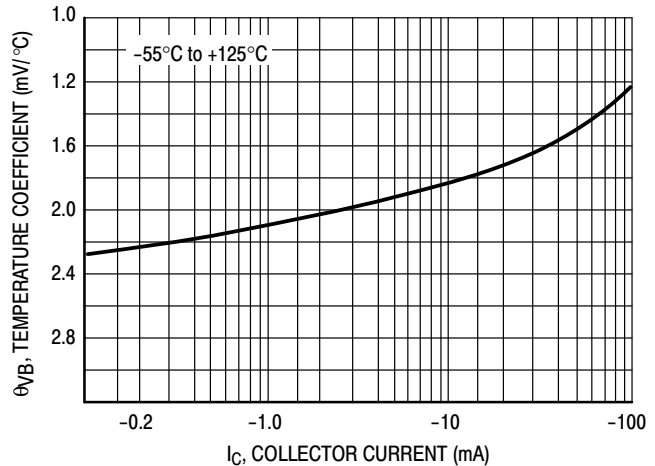

**Figure 30. Base-Emitter Temperature Coefficient**

# BC846BPDW1, BC847BPDW1, BC848CPDW1 Series

## TYPICAL PNP CHARACTERISTICS – BC847

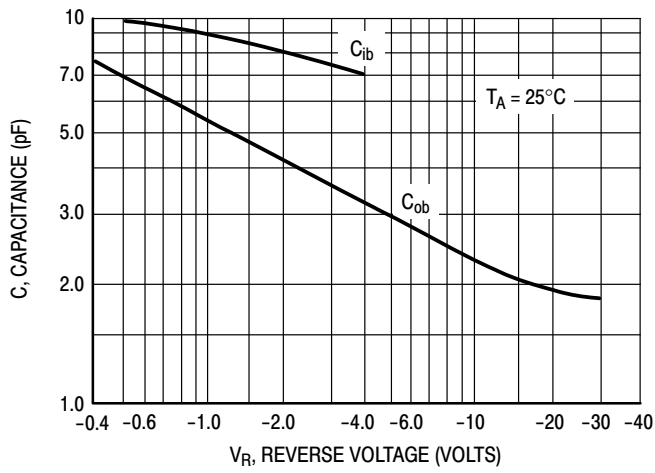

Figure 31. Capacitances

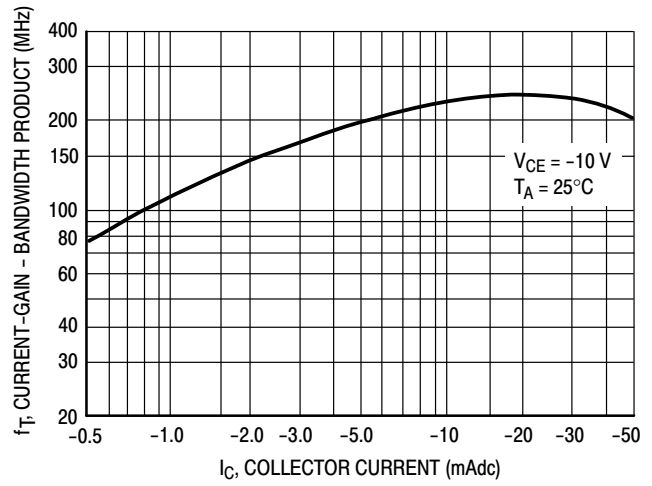
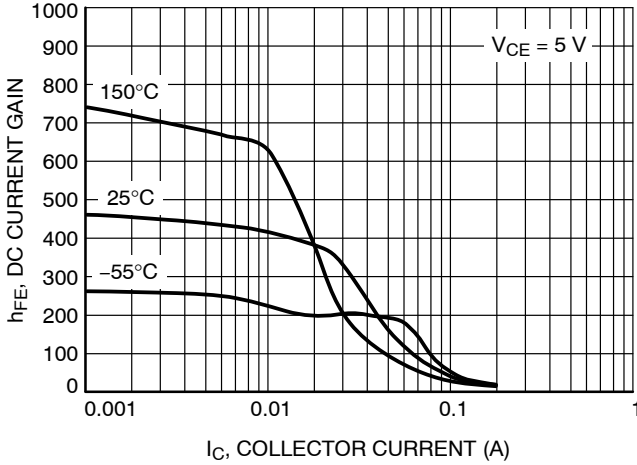

Figure 32. Current-Gain - Bandwidth Product

# BC846BPDW1, BC847BPDW1, BC848CPDW1 Series

## TYPICAL NPN CHARACTERISTICS – BC848



**Figure 33. DC Current Gain vs. Collector Current**

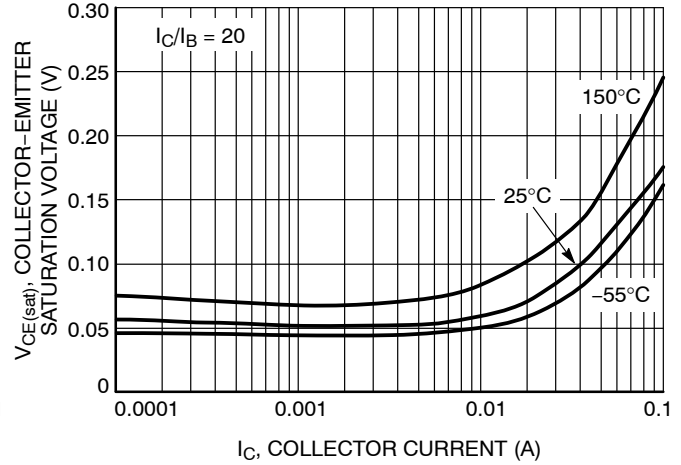

**Figure 34. Collector Emitter Saturation Voltage vs. Collector Current**

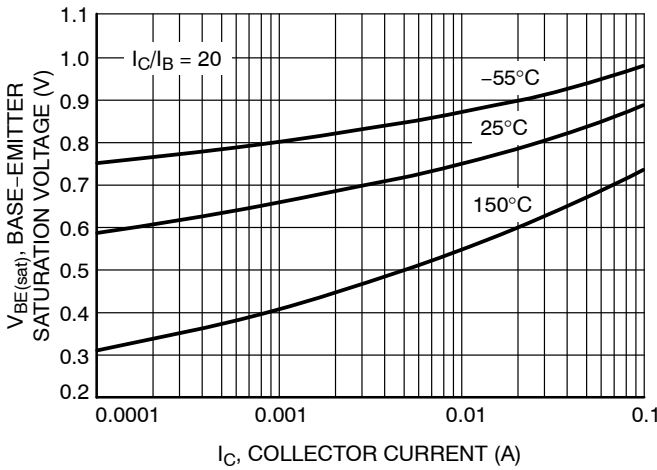

**Figure 35. Base Emitter Saturation Voltage vs. Collector Current**

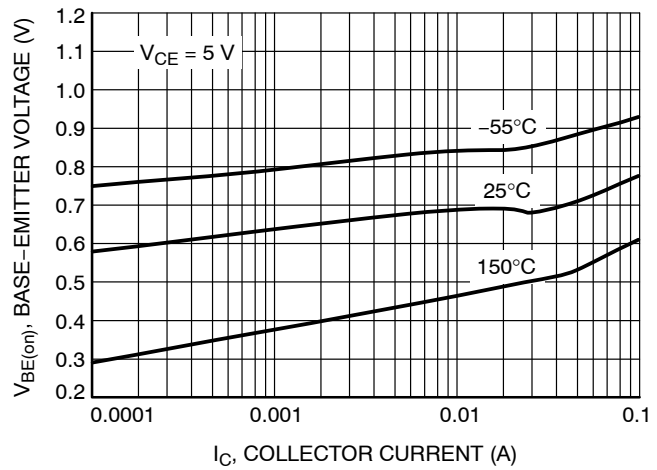

**Figure 36. Base Emitter Voltage vs. Collector Current**

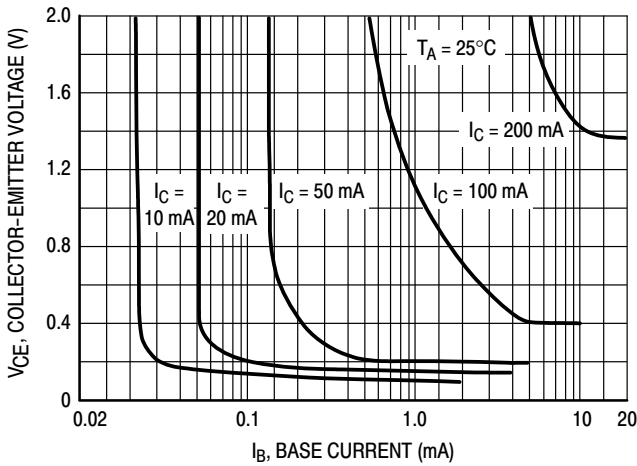

**Figure 37. Collector Saturation Region**

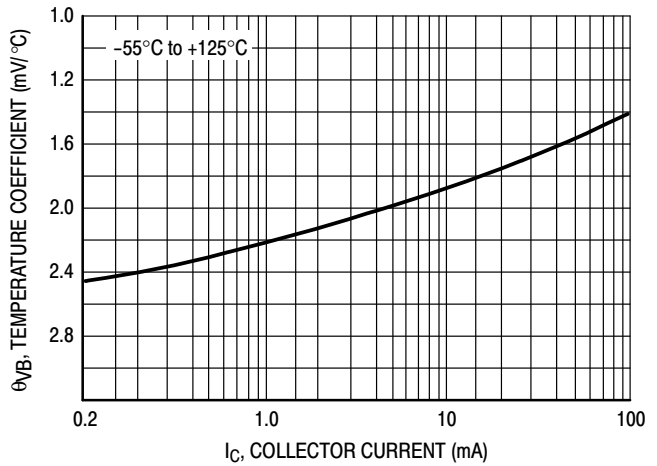

**Figure 38. Base-Emitter Temperature Coefficient**

# BC846BPDW1, BC847BPDW1, BC848CPDW1 Series

## TYPICAL NPN CHARACTERISTICS – BC848

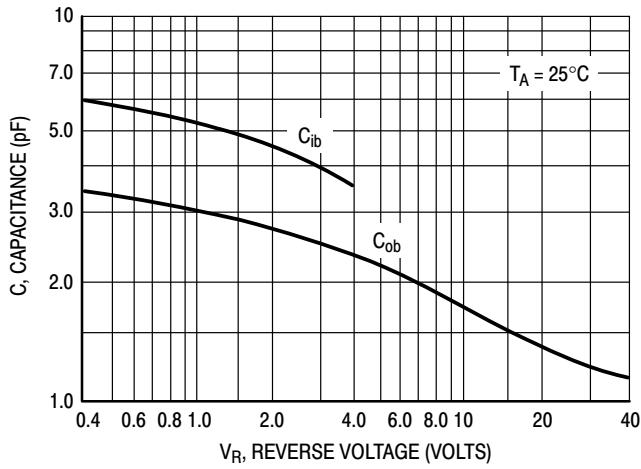

Figure 39. Capacitances

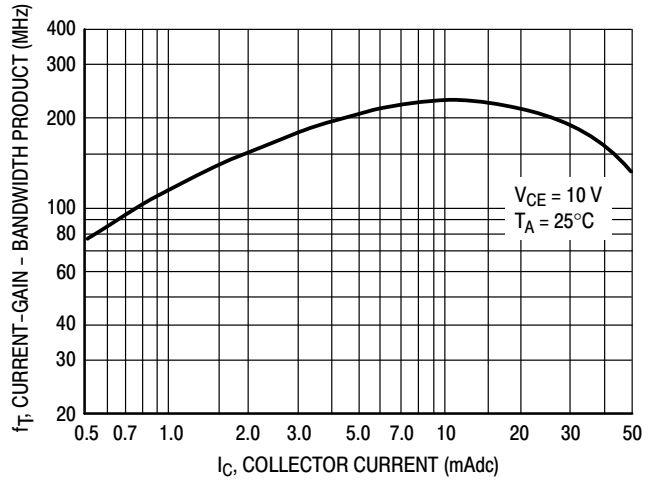
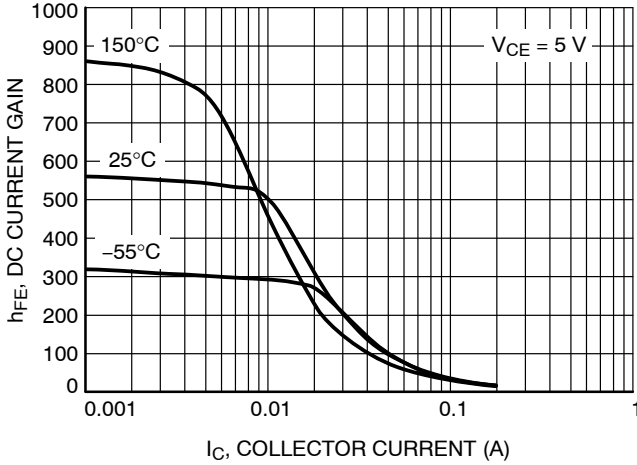

Figure 40. Current-Gain - Bandwidth Product

# BC846BPDW1, BC847BPDW1, BC848CPDW1 Series

## TYPICAL PNP CHARACTERISTICS – BC848



**Figure 41. DC Current Gain vs. Collector Current**

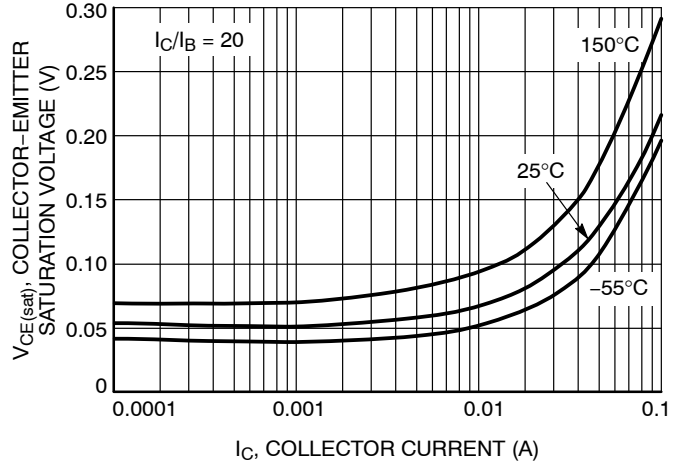

**Figure 42. Collector Emitter Saturation Voltage vs. Collector Current**

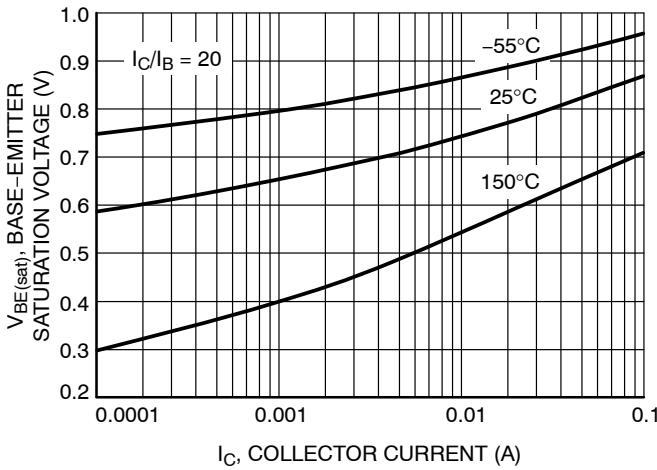

**Figure 43. Base Emitter Saturation Voltage vs. Collector Current**

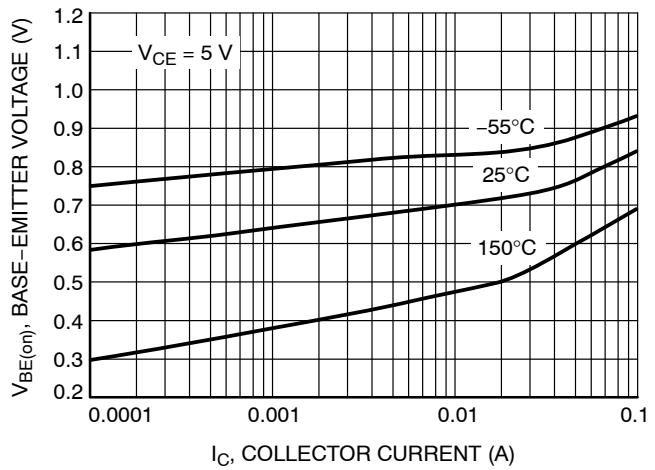

**Figure 44. Base Emitter Voltage vs. Collector Current**

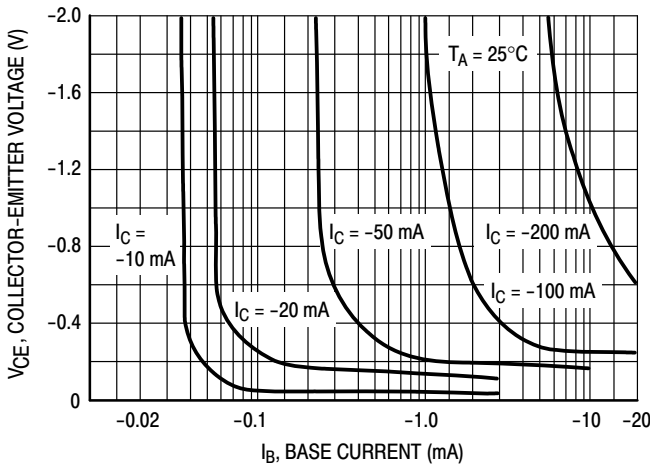

**Figure 45. Collector Saturation Region**

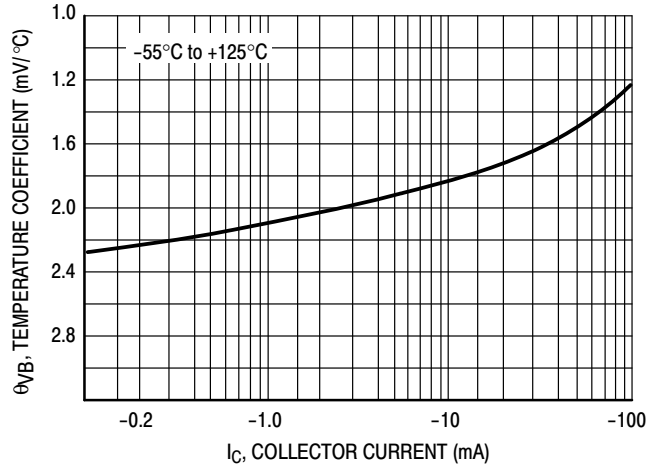

**Figure 46. Base-Emitter Temperature Coefficient**

# BC846BPDW1, BC847BPDW1, BC848CPDW1 Series

## TYPICAL PNP CHARACTERISTICS – BC848

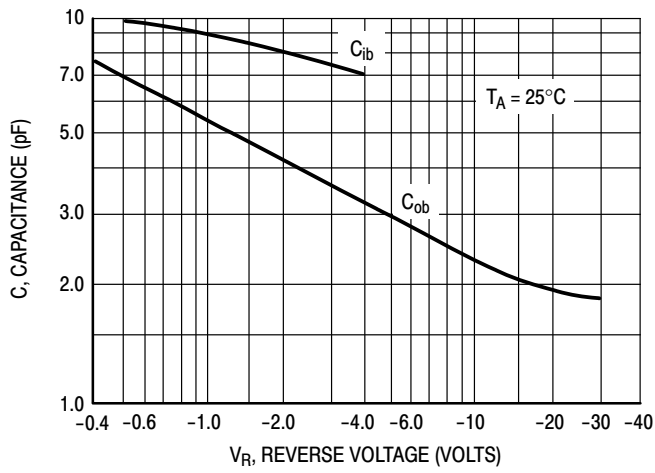

Figure 47. Capacitances

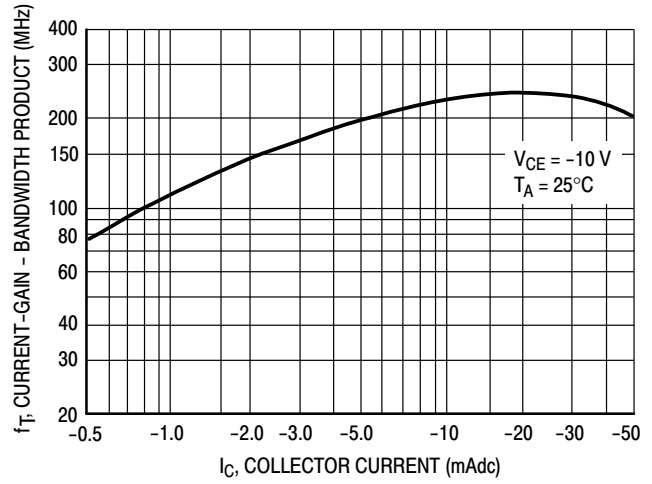

Figure 48. Current-Gain - Bandwidth Product

# BC846BPDW1, BC847BPDW1, BC848CPDW1 Series

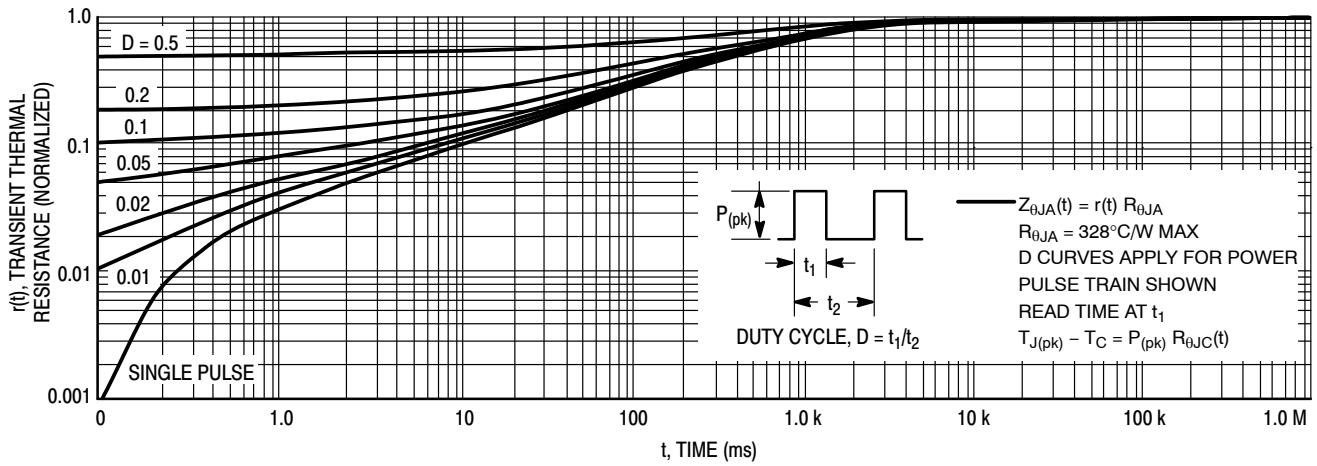

Figure 49. Thermal Response

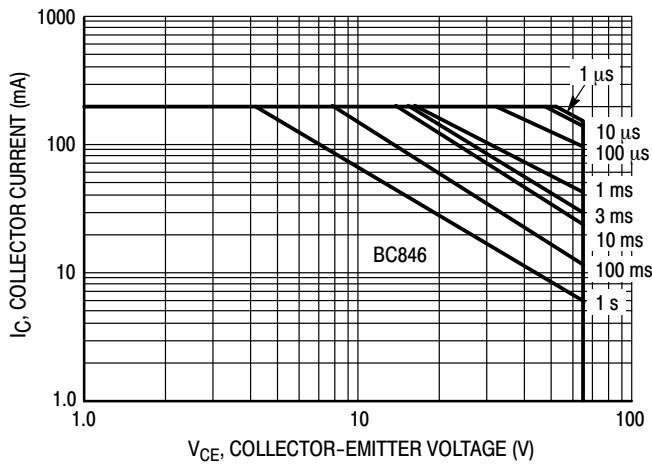

Figure 50. Safe Operating Area – BC846

The safe operating area curves indicate  $I_C$ - $V_{CE}$  limits of the transistor that must be observed for reliable operation. Collector load lines for specific circuits must fall below the limits indicated by the applicable curve.

The data of Figure 50 is based upon  $T_{J(pk)} = 150^\circ\text{C}$ ;  $T_C$  or  $T_A$  is variable depending upon conditions. Pulse curves are valid for duty cycles to 10% provided  $T_{J(pk)} \leq 150^\circ\text{C}$ .  $T_{J(pk)}$  may be calculated from the data in Figure 49. At high case or ambient temperatures, thermal limitations will reduce the power that can be handled to values less than the limitations imposed by the secondary breakdown.

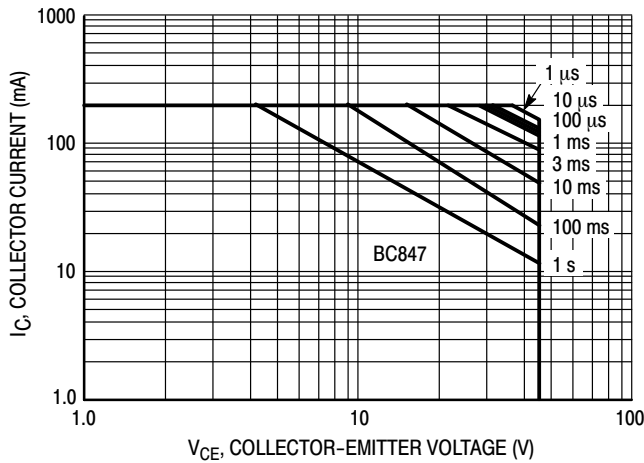

Figure 51. Safe Operating Area – BC847

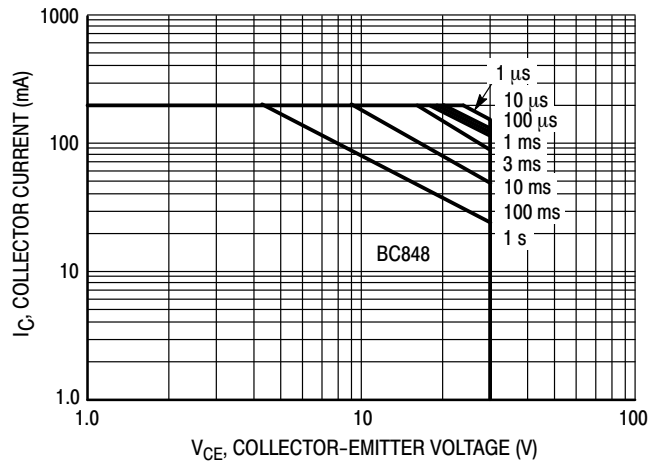

Figure 52. Safe Operating Area – BC848



# MECHANICAL CASE OUTLINE PACKAGE DIMENSIONS



1  
SCALE 2:1

SC-88/SC70-6/SOT-363  
CASE 419B-02  
ISSUE Y

DATE 11 DEC 2012

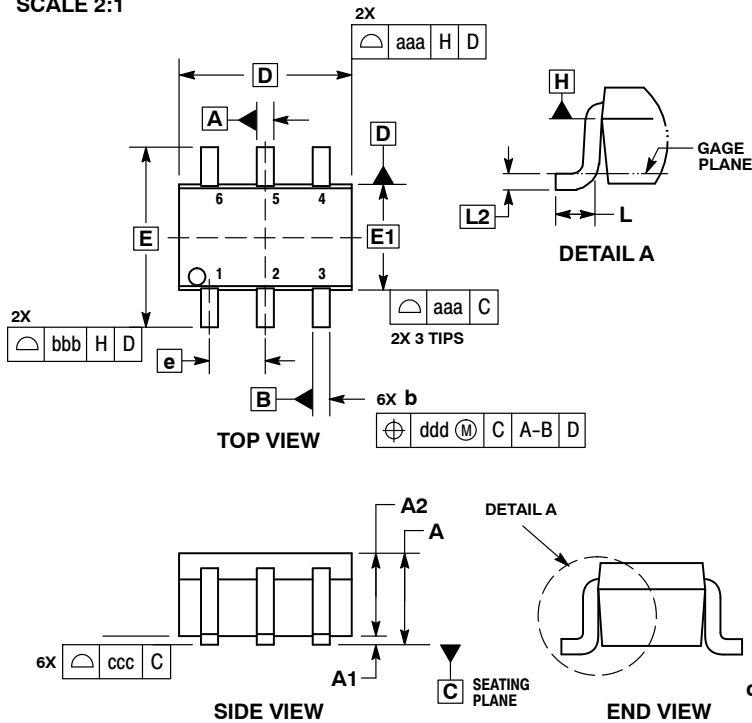

- NOTES:
1. DIMENSIONING AND TOLERANCING PER ASME Y14.5M, 1994.
  2. CONTROLLING DIMENSION: MILLIMETERS.
  3. DIMENSIONS D AND E1 DO NOT INCLUDE MOLD FLASH, PROTRUSIONS, OR GATE BURRS. MOLD FLASH, PROTRUSIONS, OR GATE BURRS SHALL NOT EXCEED 0.20 PER END.
  4. DIMENSIONS D AND E1 AT THE OUTERMOST EXTREMES OF THE PLASTIC BODY AND DATUM H.
  5. DATUMS A AND B ARE DETERMINED AT DATUM H.
  6. DIMENSIONS b AND c APPLY TO THE FLAT SECTION OF THE LEAD BETWEEN 0.08 AND 0.15 FROM THE TIP.
  7. DIMENSION b DOES NOT INCLUDE DAMBAR PROTRUSION. ALLOWABLE DAMBAR PROTRUSION SHALL BE 0.08 TOTAL IN EXCESS OF DIMENSION b AT MAXIMUM MATERIAL CONDITION. THE DAMBAR CANNOT BE LOCATED ON THE LOWER RADIUS OF THE FOOT.

DIM	MILLIMETERS			INCHES		
	MIN	NOM	MAX	MIN	NOM	MAX
A	---	---	1.10	---	---	0.043
A1	0.00	---	0.10	0.000	---	0.004
A2	0.70	0.90	1.00	0.027	0.035	0.039
b	0.15	0.20	0.25	0.006	0.008	0.010
C	0.08	0.15	0.22	0.003	0.006	0.009
D	1.80	2.00	2.20	0.070	0.078	0.086
E	2.00	2.10	2.20	0.078	0.082	0.086
E1	1.15	1.25	1.35	0.045	0.049	0.053
e	0.65 BSC			0.026 BSC		
L	0.26	0.36	0.46	0.010	0.014	0.018
L2	0.15 BSC			0.006 BSC		
aaa	0.15			0.006		
bbb	0.30			0.012		
ccc	0.10			0.004		
ddd	0.10			0.004		

### GENERIC MARKING DIAGRAM\*

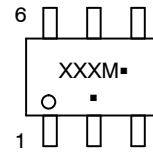

- XXX = Specific Device Code
- M = Date Code\*
- = Pb-Free Package

(Note: Microdot may be in either location)

\*Date Code orientation and/or position may vary depending upon manufacturing location.

\*This information is generic. Please refer to device data sheet for actual part marking. Pb-Free indicator, "G" or microdot "▪", may or may not be present. Some products may not follow the Generic Marking.

### RECOMMENDED SOLDERING FOOTPRINT\*

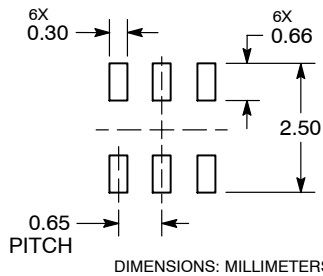

\*For additional information on our Pb-Free strategy and soldering details, please download the ON Semiconductor Soldering and Mounting Techniques Reference Manual, SOLDERRM/D.

### STYLES ON PAGE 2

DOCUMENT NUMBER:	98ASB42985B	Electronic versions are uncontrolled except when accessed directly from the Document Repository. Printed versions are uncontrolled except when stamped "CONTROLLED COPY" in red.
DESCRIPTION:	SC-88/SC70-6/SOT-363	PAGE 1 OF 2

onsemi and onsemi are trademarks of Semiconductor Components Industries, LLC dba onsemi or its subsidiaries in the United States and/or other countries. onsemi reserves the right to make changes without further notice to any products herein. onsemi makes no warranty, representation or guarantee regarding the suitability of its products for any particular purpose, nor does onsemi assume any liability arising out of the application or use of any product or circuit, and specifically disclaims any and all liability, including without limitation special, consequential or incidental damages. onsemi does not convey any license under its patent rights nor the rights of others.

**SC-88/SC70-6/SOT-363**  
**CASE 419B-02**  
**ISSUE Y**

DATE 11 DEC 2012

<b>STYLE 1:</b> PIN 1. EMITTER 2 2. BASE 2 3. COLLECTOR 1 4. EMITTER 1 5. BASE 1 6. COLLECTOR 2	<b>STYLE 2:</b> CANCELLED	<b>STYLE 3:</b> CANCELLED	<b>STYLE 4:</b> PIN 1. CATHODE 2. CATHODE 3. COLLECTOR 4. EMITTER 5. BASE 6. ANODE	<b>STYLE 5:</b> PIN 1. ANODE 2. ANODE 3. COLLECTOR 4. EMITTER 5. BASE 6. CATHODE	<b>STYLE 6:</b> PIN 1. ANODE 2 2. N/C 3. CATHODE 1 4. ANODE 1 5. N/C 6. CATHODE 2
<b>STYLE 7:</b> PIN 1. SOURCE 2 2. DRAIN 2 3. GATE 1 4. SOURCE 1 5. DRAIN 1 6. GATE 2	<b>STYLE 8:</b> CANCELLED	<b>STYLE 9:</b> PIN 1. EMITTER 2 2. EMITTER 1 3. COLLECTOR 1 4. BASE 1 5. BASE 2 6. COLLECTOR 2	<b>STYLE 10:</b> PIN 1. SOURCE 2 2. SOURCE 1 3. GATE 1 4. DRAIN 1 5. DRAIN 2 6. GATE 2	<b>STYLE 11:</b> PIN 1. CATHODE 2 2. CATHODE 2 3. ANODE 1 4. CATHODE 1 5. CATHODE 1 6. ANODE 2	<b>STYLE 12:</b> PIN 1. ANODE 2 2. ANODE 2 3. CATHODE 1 4. ANODE 1 5. ANODE 1 6. CATHODE 2
<b>STYLE 13:</b> PIN 1. ANODE 2. N/C 3. COLLECTOR 4. EMITTER 5. BASE 6. CATHODE	<b>STYLE 14:</b> PIN 1. VREF 2. GND 3. GND 4. IOUT 5. VEN 6. VCC	<b>STYLE 15:</b> PIN 1. ANODE 1 2. ANODE 2 3. ANODE 3 4. CATHODE 3 5. CATHODE 2 6. CATHODE 1	<b>STYLE 16:</b> PIN 1. BASE 1 2. EMITTER 2 3. COLLECTOR 2 4. BASE 2 5. EMITTER 1 6. COLLECTOR 1	<b>STYLE 17:</b> PIN 1. BASE 1 2. EMITTER 1 3. COLLECTOR 2 4. BASE 2 5. EMITTER 2 6. COLLECTOR 1	<b>STYLE 18:</b> PIN 1. VIN1 2. VCC 3. VOUT2 4. VIN2 5. GND 6. VOUT1
<b>STYLE 19:</b> PIN 1. IOUT 2. GND 3. GND 4. V CC 5. V EN 6. V REF	<b>STYLE 20:</b> PIN 1. COLLECTOR 2. COLLECTOR 3. BASE 4. EMITTER 5. COLLECTOR 6. COLLECTOR	<b>STYLE 21:</b> PIN 1. ANODE 1 2. N/C 3. ANODE 2 4. CATHODE 2 5. N/C 6. CATHODE 1	<b>STYLE 22:</b> PIN 1. D1 (i) 2. GND 3. D2 (j) 4. D2 (c) 5. VBUS 6. D1 (c)	<b>STYLE 23:</b> PIN 1. Vn 2. CH1 3. Vp 4. N/C 5. CH2 6. N/C	<b>STYLE 24:</b> PIN 1. CATHODE 2. ANODE 3. CATHODE 4. CATHODE 5. CATHODE 6. CATHODE
<b>STYLE 25:</b> PIN 1. BASE 1 2. CATHODE 3. COLLECTOR 2 4. BASE 2 5. EMITTER 6. COLLECTOR 1	<b>STYLE 26:</b> PIN 1. SOURCE 1 2. GATE 1 3. DRAIN 2 4. SOURCE 2 5. GATE 2 6. DRAIN 1	<b>STYLE 27:</b> PIN 1. BASE 2 2. BASE 1 3. COLLECTOR 1 4. EMITTER 1 5. EMITTER 2 6. COLLECTOR 2	<b>STYLE 28:</b> PIN 1. DRAIN 2. DRAIN 3. GATE 4. SOURCE 5. DRAIN 6. DRAIN	<b>STYLE 29:</b> PIN 1. ANODE 2. ANODE 3. COLLECTOR 4. EMITTER 5. BASE/ANODE 6. CATHODE	<b>STYLE 30:</b> PIN 1. SOURCE 1 2. DRAIN 2 3. DRAIN 2 4. SOURCE 2 5. GATE 1 6. DRAIN 1

Note: Please refer to datasheet for style callout. If style type is not called out in the datasheet refer to the device datasheet pinout or pin assignment.

<b>DOCUMENT NUMBER:</b>	<b>98ASB42985B</b>	Electronic versions are uncontrolled except when accessed directly from the Document Repository. Printed versions are uncontrolled except when stamped "CONTROLLED COPY" in red.
<b>DESCRIPTION:</b>	<b>SC-88/SC70-6/SOT-363</b>	<b>PAGE 2 OF 2</b>

**onsemi** and **ONSEMI** are trademarks of Semiconductor Components Industries, LLC dba **onsemi** or its subsidiaries in the United States and/or other countries. **onsemi** reserves the right to make changes without further notice to any products herein. **onsemi** makes no warranty, representation or guarantee regarding the suitability of its products for any particular purpose, nor does **onsemi** assume any liability arising out of the application or use of any product or circuit, and specifically disclaims any and all liability, including without limitation special, consequential or incidental damages. **onsemi** does not convey any license under its patent rights nor the rights of others.

**onsemi**, **Onsemi**, and other names, marks, and brands are registered and/or common law trademarks of Semiconductor Components Industries, LLC dba "**onsemi**" or its affiliates and/or subsidiaries in the United States and/or other countries. **onsemi** owns the rights to a number of patents, trademarks, copyrights, trade secrets, and other intellectual property. A listing of **onsemi**'s product/patent coverage may be accessed at [www.onsemi.com/site/pdf/Patent-Marking.pdf](http://www.onsemi.com/site/pdf/Patent-Marking.pdf). **onsemi** reserves the right to make changes at any time to any products or information herein, without notice. The information herein is provided "as-is" and **onsemi** makes no warranty, representation or guarantee regarding the accuracy of the information, product features, availability, functionality, or suitability of its products for any particular purpose, nor does **onsemi** assume any liability arising out of the application or use of any product or circuit, and specifically disclaims any and all liability, including without limitation special, consequential or incidental damages. Buyer is responsible for its products and applications using **onsemi** products, including compliance with all laws, regulations and safety requirements or standards, regardless of any support or applications information provided by **onsemi**. "Typical" parameters which may be provided in **onsemi** data sheets and/or specifications can and do vary in different applications and actual performance may vary over time. All operating parameters, including "Typicals" must be validated for each customer application by customer's technical experts. **onsemi** does not convey any license under any of its intellectual property rights nor the rights of others. **onsemi** products are not designed, intended, or authorized for use as a critical component in life support systems or any FDA Class 3 medical devices or medical devices with a same or similar classification in a foreign jurisdiction or any devices intended for implantation in the human body. Should Buyer purchase or use **onsemi** products for any such unintended or unauthorized application, Buyer shall indemnify and hold **onsemi** and its officers, employees, subsidiaries, affiliates, and distributors harmless against all claims, costs, damages, and expenses, and reasonable attorney fees arising out of, directly or indirectly, any claim of personal injury or death associated with such unintended or unauthorized use, even if such claim alleges that **onsemi** was negligent regarding the design or manufacture of the part. **onsemi** is an Equal Opportunity/Affirmative Action Employer. This literature is subject to all applicable copyright laws and is not for resale in any manner.

## ADDITIONAL INFORMATION

### TECHNICAL PUBLICATIONS:

Technical Library: [www.onsemi.com/design/resources/technical-documentation](http://www.onsemi.com/design/resources/technical-documentation)  
onsemi Website: [www.onsemi.com](http://www.onsemi.com)

### ONLINE SUPPORT: [www.onsemi.com/support](http://www.onsemi.com/support)

For additional information, please contact your local Sales Representative at [www.onsemi.com/support/sales](http://www.onsemi.com/support/sales)