

74FST3257

Quad 2:1 Multiplexer/ Demultiplexer Bus Switch

The ON Semiconductor 74FST3257 is a quad 2:1, high performance multiplexer/demultiplexer bus switch. The device is CMOS TTL compatible when operating between 4 and 5.5 Volts. The device exhibits extremely low R_{ON} and adds nearly zero propagation delay. The device adds no noise or ground bounce to the system.

Features

- $R_{ON} < 4 \Omega$ Typical
- Less Than 0.25 ns–Max Delay Through Switch
- Nearly Zero Standby Current
- No Circuit Bounce
- Control Inputs are TTL/CMOS Compatible
- Pin–For–Pin Compatible With QS3257, FST3257, CBT3257
- All Popular Packages: SOIC–16, TSSOP–16, QFN16
- NLV Prefix for Automotive and Other Applications Requiring Unique Site and Control Change Requirements; AEC–Q100 Qualified and PPAP Capable
- These Devices are Pb–Free, Halogen Free/BFR Free and are RoHS Compliant

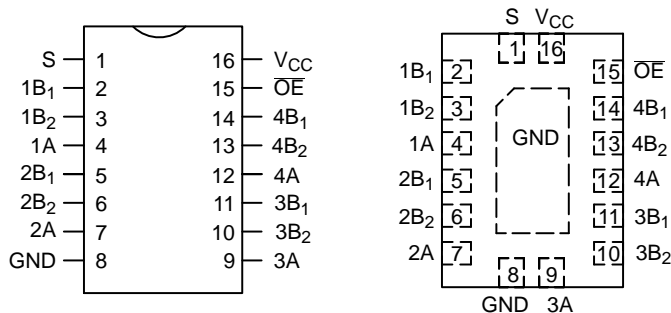

Figure 1. 16–Lead Pinout Diagrams

S	\overline{OE}	Function
X	H	Disconnect
L	L	A = B ₁
H	L	A = B ₂

Figure 2. Truth Table



ON Semiconductor®

www.onsemi.com

MARKING DIAGRAMS

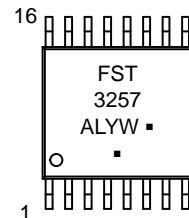
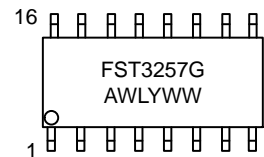

QFN16
MN SUFFIX
CASE 485AW

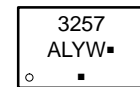

A = Assembly Location
WL, L = Wafer Lot
Y = Year
WW, W = Work Week
G or ■ = Pb–Free Package

(Note: Microdot may be in either location)

PIN NAMES

Pin	Description
$\overline{OE}_1, \overline{OE}_2$	Bus Switch Enables
S ₀ , S ₁	Select Inputs
A	Bus A
B ₁ , B ₂ , B ₃ , B ₄	Bus B

ORDERING INFORMATION

See detailed ordering and shipping information in the package dimensions section on page 2 of this data sheet.

74FST3257

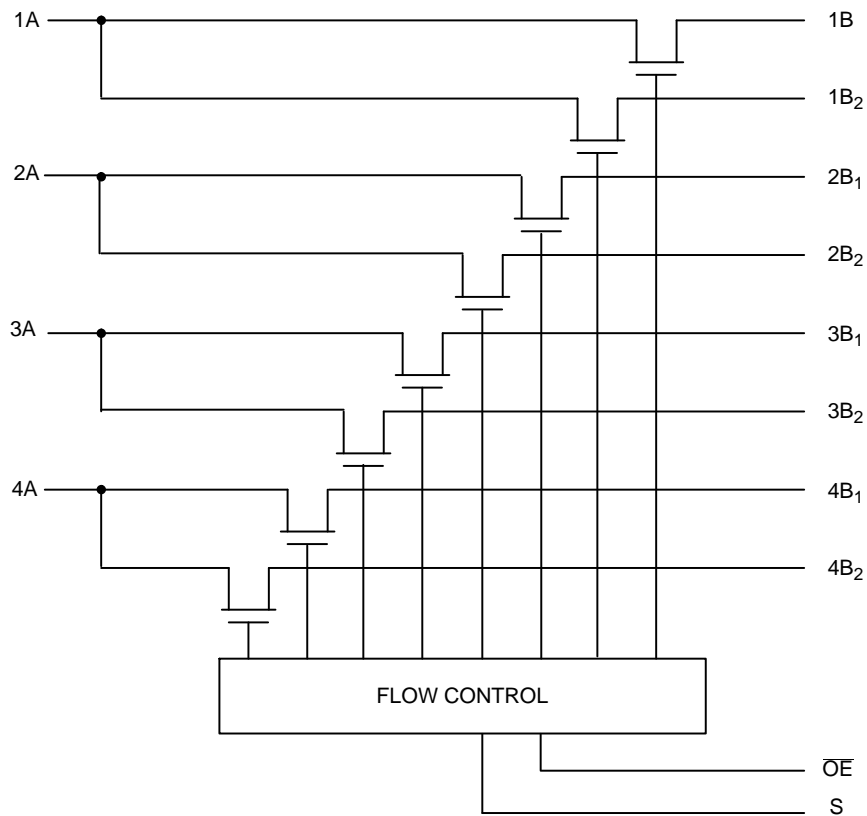

Figure 3. Logic Diagram

ORDERING INFORMATION

Device Order Number	Package	Shipping†
74FST3257DR2G	SOIC-16 (Pb-Free)	2500 Units / Tape & Reel
NLV74FST3257DR2G*		
74FST3257DTR2G	TSSOP-16 (Pb-Free)	2500 Units / Tape & Reel
74FST3257MNTWG	QFN16 (Pb-Free)	3000 Units / Tape & Reel

†For information on tape and reel specifications, including part orientation and tape sizes, please refer to our Tape and Reel Packaging Specifications Brochure, BRD8011/D.

*NLV Prefix for Automotive and Other Applications Requiring Unique Site and Control Change Requirements; AEC-Q100 Qualified and PPAP Capable.

MAXIMUM RATINGS

Symbol	Parameter	Value	Units
V_{CC}	DC Supply Voltage	-0.5 to +7.0	V
V_I	DC Input Voltage	-0.5 to +7.0	V
V_O	DC Output Voltage	-0.5 to +7.0	V
I_{IK}	DC Input Diode Current $V_I < GND$	-50	mA
I_{OK}	DC Output Diode Current $V_O < GND$	-50	mA
I_O	DC Output Sink Current	128	mA
I_{CC}	DC Supply Current per Supply Pin	± 100	mA
I_{GND}	DC Ground Current per Ground Pin	± 100	mA
T_{STG}	Storage Temperature Range	-65 to +150	$^{\circ}C$
T_L	Lead Temperature, 1 mm from Case for 10 Seconds	260	$^{\circ}C$
T_J	Junction Temperature Under Bias	+150	$^{\circ}C$
θ_{JA}	Thermal Resistance SOIC TSSOP QFN	125 170 N/A	$^{\circ}C/W$
MSL	Moisture Sensitivity	Level 1	
F_R	Flammability Rating Oxygen Index: 28 to 34	UL 94 V-0 @ 0.125 in	
V_{ESD}	ESD Withstand Voltage Human Body Model (Note 1) Machine Model (Note 2) Charged Device Model (Note 3)	> 2000 > 200 N/A	V
$I_{Latchup}$	Latchup Performance Above V_{CC} and Below GND at 85 $^{\circ}C$ (Note 4)	± 500	mA

Stresses exceeding those listed in the Maximum Ratings table may damage the device. If any of these limits are exceeded, device functionality should not be assumed, damage may occur and reliability may be affected.

1. Tested to EIA/JESD22-A114-A.
2. Tested to EIA/JESD22-A115-A.
3. Tested to JESD22-C101-A.
4. Tested to EIA/JESD78.

RECOMMENDED OPERATING CONDITIONS

Symbol	Parameter	Min	Max	Units
V_{CC}	Supply Voltage Operating, Data Retention Only	4.0	5.5	V
V_I	Input Voltage (Note 5)	0	5.5	V
V_O	Output Voltage (HIGH or LOW State)	0	5.5	V
T_A	Operating Free-Air Temperature	-40	+85	$^{\circ}C$
$\Delta t/\Delta V$	Input Transition Rise or Fall Rate Switch I/O		DC 5	ns/V
	Switch Control Input $V_{CC} = 5.0 V \pm 0.5 V$	0		

5. Unused control inputs may not be left open. All control inputs must be tied to a high or low logic input voltage level.

74FST3257

DC ELECTRICAL CHARACTERISTICS

Symbol	Parameter	Conditions	V _{CC} (V)	T _A = -40°C to +85°C			Units
				Min	Typ*	Max	
V _{IK}	Clamp Diode Voltage	I _{IN} = -18 mA	4.5			-1.2	V
V _{IH}	High-Level Input Voltage		4.0 to 5.5	2.0			V
V _{IL}	Low-Level Input Voltage		4.0 to 5.5			0.8	V
I _I	Input Leakage Current	0 ≤ V _{IN} ≤ 5.5 V	5.5			±1.0	μA
I _{OZ}	Off-State Leakage Current	0 ≤ A, B ≤ V _{CC}	5.5			±1.0	μA
R _{ON}	Switch On Resistance (Note 6)	V _{IN} = 0 V, I _{IN} = 64 mA	4.5		4	7	Ω
		V _{IN} = 0 V, I _{IN} = 30 mA	4.5		4	7	
		V _{IN} = 2.4 V, I _{IN} = 15 mA	4.5		8	15	
		V _{IN} = 2.4 V, I _{IN} = 15 mA	4.0		11	20	
I _{CC}	Quiescent Supply Current	V _{IN} = V _{CC} or GND, I _{OUT} = 0	5.5			3	μA
ΔI _{CC}	Increase In I _{CC} per Input	One input at 3.4 V, Other inputs at V _{CC} or GND	5.5			2.5	mA

*Typical values are at V_{CC} = 5.0 V and T_A = 25°C.

6. Measured by the voltage drop between A and B pins at the indicated current through the switch. On resistance is determined by the lower of the voltages on the two (A or B) pins.

AC ELECTRICAL CHARACTERISTICS

Symbol	Parameter	Conditions	T _A = -40°C to +85°C C _L = 50 pF, R _U = R _D = 500 Ω				Units
			V _{CC} = 4.5-5.5 V		V _{CC} = 4.0 V		
			Min	Max	Min	Max	
t _{PHL} , t _{PLH}	Prop Delay Bus to Bus (Note 7)	V _I = OPEN		0.25		0.25	ns
	Prop Delay, Select to Bus A		1.0	4.7		5.2	
t _{PZH} , t _{PZL}	Output Enable Time, Select to Bus B	V _I = 7 V for t _{PZL}	1.0	5.2		5.7	ns
	Output Enable Time, I _{OE} to Bus A, B	V _I = OPEN for t _{PZH}	1.0	5.1		5.6	
t _{PHZ} , t _{PLZ}	Output Disable Time, Select to Bus B	V _I = 7 V for t _{PLZ}	1.0	5.2		5.5	ns
	Output Disable Time, I _{OE} to Bus A, B	V _I = OPEN for t _{PHZ}	1.0	5.5		5.5	

7. This parameter is guaranteed by design but is not tested. The bus switch contributes no propagation delay other than the RC delay of the typical On resistance of the switch and the 50 pF load capacitance, when driven by an ideal voltage source (zero output impedance).

CAPACITANCE (Note 8)

Symbol	Parameter	Conditions	Typ	Max	Units
C _{IN}	Control Pin Input Capacitance	V _{CC} = 5.0 V	3		pF
C _{I/O}	A Port Input/Output Capacitance	V _{CC} , \overline{OE} = 5.0 V	7		pF
C _{I/O}	B Port Input/Output Capacitance	V _{CC} , \overline{OE} = 5.0 V	5		pF

8. T_A = +25°C, f = 1 MHz, Capacitance is characterized but not tested.

74FST3257

AC Loading and Waveforms

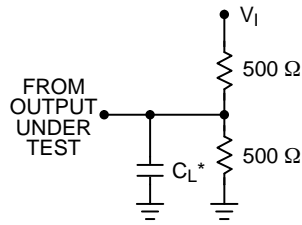

NOTES:

1. Input driven by 50 Ω source terminated in 50 Ω.
 2. CL includes load and stray capacitance.
- *CL = 50 pF

Figure 4. AC Test Circuit

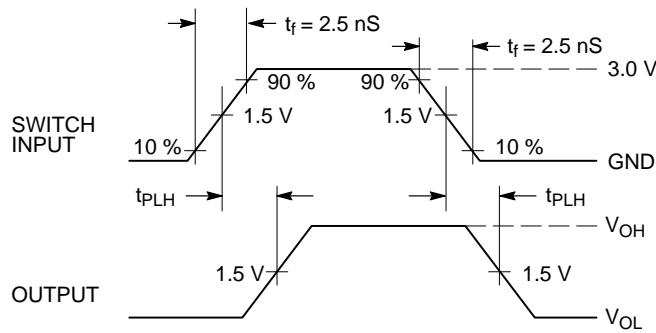

Figure 5. Propagation Delays

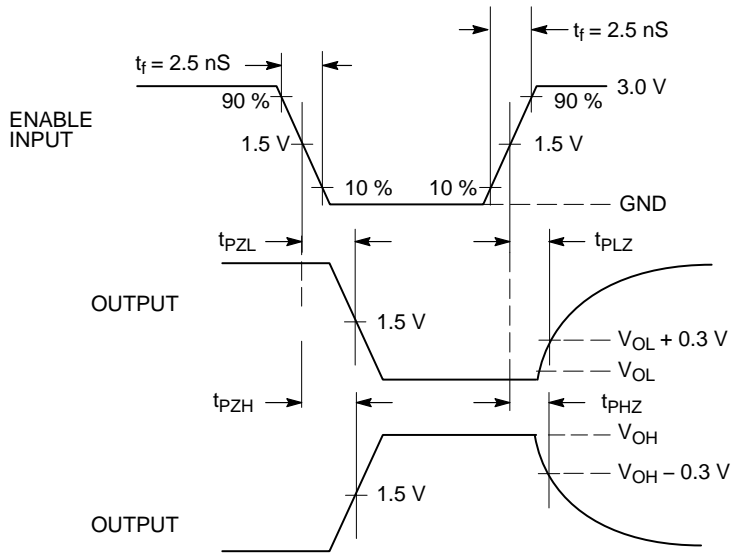

Figure 6. Enable/Disable Delays

MECHANICAL CASE OUTLINE PACKAGE DIMENSIONS

ON Semiconductor®



SCALE 1:1

SOIC-16 CASE 751B-05 ISSUE K

DATE 29 DEC 2006



NOTES:

1. DIMENSIONING AND TOLERANCING PER ANSI Y14.5M, 1982.
2. CONTROLLING DIMENSION: MILLIMETER.
3. DIMENSIONS A AND B DO NOT INCLUDE MOLD PROTRUSION.
4. MAXIMUM MOLD PROTRUSION 0.15 (0.006) PER SIDE.
5. DIMENSION D DOES NOT INCLUDE DAMBAR PROTRUSION. ALLOWABLE DAMBAR PROTRUSION SHALL BE 0.127 (0.005) TOTAL IN EXCESS OF THE D DIMENSION AT MAXIMUM MATERIAL CONDITION.

DIM	MILLIMETERS		INCHES	
	MIN	MAX	MIN	MAX
A	9.80	10.00	0.386	0.393
B	3.80	4.00	0.150	0.157
C	1.35	1.75	0.054	0.068
D	0.35	0.49	0.014	0.019
F	0.40	1.25	0.016	0.049
G	1.27 BSC		0.050 BSC	
J	0.19	0.25	0.008	0.009
K	0.10	0.25	0.004	0.009
M	0°	7°	0°	7°
P	5.80	6.20	0.229	0.244
R	0.25	0.50	0.010	0.019

- | | | | |
|----------------------------------------------------------------------------------------------------------------------------------------------------------------------------------------------------------------------------------------------------------------------------------------------------------------------------------------------------------------|--------------------------------------------------------------------------------------------------------------------------------------------------------------------------------------------------------------------------------------------------------------------------------------------------------------------------------------------|--------------------------------------------------------------------------------------------------------------------------------------------------------------------------------------------------------------------------------------------------------------------------------------------------------------------------------------------------------------------------------------------------------------------------------------------------------------------------------------------|----------------------------------------------------------------------------------------------------------------------------------------------------------------------------------------------------------------------------------------------------------------------------------------------------------------------------------------------------------------------------------------------------|
| <p>STYLE 1:</p> <p>PIN 1. COLLECTOR</p> <p>2. BASE</p> <p>3. EMITTER</p> <p>4. NO CONNECTION</p> <p>5. EMITTER</p> <p>6. BASE</p> <p>7. COLLECTOR</p> <p>8. COLLECTOR</p> <p>9. BASE</p> <p>10. EMITTER</p> <p>11. NO CONNECTION</p> <p>12. EMITTER</p> <p>13. BASE</p> <p>14. COLLECTOR</p> <p>15. EMITTER</p> <p>16. COLLECTOR</p> | <p>STYLE 2:</p> <p>PIN 1. CATHODE</p> <p>2. ANODE</p> <p>3. NO CONNECTION</p> <p>4. CATHODE</p> <p>5. CATHODE</p> <p>6. NO CONNECTION</p> <p>7. ANODE</p> <p>8. CATHODE</p> <p>9. CATHODE</p> <p>10. ANODE</p> <p>11. NO CONNECTION</p> <p>12. CATHODE</p> <p>13. CATHODE</p> <p>14. NO CONNECTION</p> <p>15. ANODE</p> <p>16. CATHODE</p> | <p>STYLE 3:</p> <p>PIN 1. COLLECTOR, DYE #1</p> <p>2. BASE, #1</p> <p>3. EMITTER, #1</p> <p>4. COLLECTOR, #1</p> <p>5. COLLECTOR, #2</p> <p>6. BASE, #2</p> <p>7. EMITTER, #2</p> <p>8. COLLECTOR, #2</p> <p>9. COLLECTOR, #3</p> <p>10. BASE, #3</p> <p>11. EMITTER, #3</p> <p>12. COLLECTOR, #3</p> <p>13. COLLECTOR, #4</p> <p>14. BASE, #4</p> <p>15. EMITTER, #4</p> <p>16. COLLECTOR, #4</p> | <p>STYLE 4:</p> <p>PIN 1. COLLECTOR, DYE #1</p> <p>2. COLLECTOR, #1</p> <p>3. COLLECTOR, #2</p> <p>4. COLLECTOR, #2</p> <p>5. COLLECTOR, #3</p> <p>6. COLLECTOR, #3</p> <p>7. COLLECTOR, #4</p> <p>8. COLLECTOR, #4</p> <p>9. BASE, #4</p> <p>10. EMITTER, #4</p> <p>11. BASE, #3</p> <p>12. EMITTER, #3</p> <p>13. BASE, #2</p> <p>14. EMITTER, #2</p> <p>15. BASE, #1</p> <p>16. EMITTER, #1</p> |
| <p>STYLE 5:</p> <p>PIN 1. DRAIN, DYE #1</p> <p>2. DRAIN, #1</p> <p>3. DRAIN, #2</p> <p>4. DRAIN, #2</p> <p>5. DRAIN, #3</p> <p>6. DRAIN, #3</p> <p>7. DRAIN, #4</p> <p>8. DRAIN, #4</p> <p>9. GATE, #4</p> <p>10. SOURCE, #4</p> <p>11. GATE, #3</p> <p>12. SOURCE, #3</p> <p>13. GATE, #2</p> <p>14. SOURCE, #2</p> <p>15. GATE, #1</p> <p>16. SOURCE, #1</p> | <p>STYLE 6:</p> <p>PIN 1. CATHODE</p> <p>2. CATHODE</p> <p>3. CATHODE</p> <p>4. CATHODE</p> <p>5. CATHODE</p> <p>6. CATHODE</p> <p>7. CATHODE</p> <p>8. CATHODE</p> <p>9. ANODE</p> <p>10. ANODE</p> <p>11. ANODE</p> <p>12. ANODE</p> <p>13. ANODE</p> <p>14. ANODE</p> <p>15. ANODE</p> <p>16. ANODE</p> | <p>STYLE 7:</p> <p>PIN 1. SOURCE N-CH</p> <p>2. COMMON DRAIN (OUTPUT)</p> <p>3. COMMON DRAIN (OUTPUT)</p> <p>4. GATE P-CH</p> <p>5. COMMON DRAIN (OUTPUT)</p> <p>6. COMMON DRAIN (OUTPUT)</p> <p>7. COMMON DRAIN (OUTPUT)</p> <p>8. SOURCE P-CH</p> <p>9. SOURCE P-CH</p> <p>10. COMMON DRAIN (OUTPUT)</p> <p>11. COMMON DRAIN (OUTPUT)</p> <p>12. COMMON DRAIN (OUTPUT)</p> <p>13. GATE N-CH</p> <p>14. COMMON DRAIN (OUTPUT)</p> <p>15. COMMON DRAIN (OUTPUT)</p> <p>16. SOURCE N-CH</p> | |

SOLDERING FOOTPRINT



DIMENSIONS: MILLIMETERS

DOCUMENT NUMBER:	98ASB42566B	Electronic versions are uncontrolled except when accessed directly from the Document Repository. Printed versions are uncontrolled except when stamped "CONTROLLED COPY" in red.
DESCRIPTION:	SOIC-16	PAGE 1 OF 1

ON Semiconductor and are trademarks of Semiconductor Components Industries, LLC dba ON Semiconductor or its subsidiaries in the United States and/or other countries. ON Semiconductor reserves the right to make changes without further notice to any products herein. ON Semiconductor makes no warranty, representation or guarantee regarding the suitability of its products for any particular purpose, nor does ON Semiconductor assume any liability arising out of the application or use of any product or circuit, and specifically disclaims any and all liability, including without limitation special, consequential or incidental damages. ON Semiconductor does not convey any license under its patent rights nor the rights of others.

MECHANICAL CASE OUTLINE

PACKAGE DIMENSIONS

ON Semiconductor®



TSSOP-16
CASE 948F-01
ISSUE B

DATE 19 OCT 2006



NOTES:

1. DIMENSIONING AND TOLERANCING PER ANSI Y14.5M, 1982.
2. CONTROLLING DIMENSION: MILLIMETER.
3. DIMENSION A DOES NOT INCLUDE MOLD FLASH. PROTRUSIONS OR GATE BURRS. MOLD FLASH OR GATE BURRS SHALL NOT EXCEED 0.15 (0.006) PER SIDE.
4. DIMENSION B DOES NOT INCLUDE INTERLEAD FLASH OR PROTRUSION. INTERLEAD FLASH OR PROTRUSION SHALL NOT EXCEED 0.25 (0.010) PER SIDE.
5. DIMENSION K DOES NOT INCLUDE DAMBAR PROTRUSION. ALLOWABLE DAMBAR PROTRUSION SHALL BE 0.08 (0.003) TOTAL IN EXCESS OF THE K DIMENSION AT MAXIMUM MATERIAL CONDITION.
6. TERMINAL NUMBERS ARE SHOWN FOR REFERENCE ONLY.
7. DIMENSION A AND B ARE TO BE DETERMINED AT DATUM PLANE -W-.

DIM	MILLIMETERS		INCHES	
	MIN	MAX	MIN	MAX
A	4.90	5.10	0.193	0.200
B	4.30	4.50	0.169	0.177
C	---	1.20	---	0.047
D	0.05	0.15	0.002	0.006
F	0.50	0.75	0.020	0.030
G	0.65 BSC		0.026 BSC	
H	0.18	0.28	0.007	0.011
J	0.09	0.20	0.004	0.008
J1	0.09	0.16	0.004	0.006
K	0.19	0.30	0.007	0.012
K1	0.19	0.25	0.007	0.010
L	6.40 BSC		0.252 BSC	
M	0°	8°	0°	8°

SOLDERING FOOTPRINT



GENERIC MARKING DIAGRAM*



- XXXX = Specific Device Code
- A = Assembly Location
- L = Wafer Lot
- Y = Year
- W = Work Week
- G or ■ = Pb-Free Package

*This information is generic. Please refer to device data sheet for actual part marking. Pb-Free indicator, "G" or microdot "■", may or may not be present.

DOCUMENT NUMBER:	98ASH70247A	Electronic versions are uncontrolled except when accessed directly from the Document Repository. Printed versions are uncontrolled except when stamped "CONTROLLED COPY" in red.
DESCRIPTION:	TSSOP-16	PAGE 1 OF 1

ON Semiconductor and ON are trademarks of Semiconductor Components Industries, LLC dba ON Semiconductor or its subsidiaries in the United States and/or other countries. ON Semiconductor reserves the right to make changes without further notice to any products herein. ON Semiconductor makes no warranty, representation or guarantee regarding the suitability of its products for any particular purpose, nor does ON Semiconductor assume any liability arising out of the application or use of any product or circuit, and specifically disclaims any and all liability, including without limitation special, consequential or incidental damages. ON Semiconductor does not convey any license under its patent rights nor the rights of others.

ON Semiconductor and  are trademarks of Semiconductor Components Industries, LLC dba ON Semiconductor or its subsidiaries in the United States and/or other countries. ON Semiconductor owns the rights to a number of patents, trademarks, copyrights, trade secrets, and other intellectual property. A listing of ON Semiconductor's product/patent coverage may be accessed at www.onsemi.com/site/pdf/Patent-Marking.pdf. ON Semiconductor reserves the right to make changes without further notice to any products herein. ON Semiconductor makes no warranty, representation or guarantee regarding the suitability of its products for any particular purpose, nor does ON Semiconductor assume any liability arising out of the application or use of any product or circuit, and specifically disclaims any and all liability, including without limitation special, consequential or incidental damages. Buyer is responsible for its products and applications using ON Semiconductor products, including compliance with all laws, regulations and safety requirements or standards, regardless of any support or applications information provided by ON Semiconductor. "Typical" parameters which may be provided in ON Semiconductor data sheets and/or specifications can and do vary in different applications and actual performance may vary over time. All operating parameters, including "Typicals" must be validated for each customer application by customer's technical experts. ON Semiconductor does not convey any license under its patent rights nor the rights of others. ON Semiconductor products are not designed, intended, or authorized for use as a critical component in life support systems or any FDA Class 3 medical devices or medical devices with a same or similar classification in a foreign jurisdiction or any devices intended for implantation in the human body. Should Buyer purchase or use ON Semiconductor products for any such unintended or unauthorized application, Buyer shall indemnify and hold ON Semiconductor and its officers, employees, subsidiaries, affiliates, and distributors harmless against all claims, costs, damages, and expenses, and reasonable attorney fees arising out of, directly or indirectly, any claim of personal injury or death associated with such unintended or unauthorized use, even if such claim alleges that ON Semiconductor was negligent regarding the design or manufacture of the part. ON Semiconductor is an Equal Opportunity/Affirmative Action Employer. This literature is subject to all applicable copyright laws and is not for resale in any manner.

PUBLICATION ORDERING INFORMATION

LITERATURE FULFILLMENT:

Email Requests to: orderlit@onsemi.com

ON Semiconductor Website: www.onsemi.com

TECHNICAL SUPPORT

North American Technical Support:
Voice Mail: 1 800-282-9855 Toll Free USA/Canada
Phone: 011 421 33 790 2910

Europe, Middle East and Africa Technical Support:

Phone: 00421 33 790 2910

For additional information, please contact your local Sales Representative