

2N6497

High Voltage NPN Silicon Power Transistors

These devices are designed for high voltage inverters, switching regulators and line-operated amplifier applications. Especially well suited for switching power supply applications.

Features

- High Collector–Emitter Sustaining Voltage –
 $V_{CEO(sus)} = 250 \text{ Vdc (Min)}$
- Excellent DC Current Gain –
 $h_{FE} = 10\text{--}75 @ I_C = 2.5 \text{ Adc}$
- Low Collector–Emitter Saturation Voltage @ $I_C = 2.5 \text{ Adc}$ –
 $V_{CE(sat)} = 1.0 \text{ Vdc (Max)}$
- Pb–Free Packages are Available*

MAXIMUM RATINGS (Note 1)

| Rating | Symbol | Value | Unit |
|---|----------------|-------------|--------------------------|
| Collector–Emitter Voltage | V_{CEO} | 250 | Vdc |
| Collector–Base Voltage | V_{CB} | 350 | Vdc |
| Emitter–Base Voltage | V_{EB} | 6.0 | Vdc |
| Collector Current – Continuous – Peak | I_C | 5.0 10 | Adc |
| Base Current | I_B | 2.0 | Adc |
| Total Power Dissipation @ $T_C = 25^\circ\text{C}$ Derate above 25°C | P_D | 80 0.64 | W W/ $^\circ\text{C}$ |
| Operating and Storage Junction Temperature Range | T_J, T_{stg} | –65 to +150 | $^\circ\text{C}$ |

THERMAL CHARACTERISTICS

| Characteristics | Symbol | Max | Unit |
|--------------------------------------|-----------------|------|--------------------|
| Thermal Resistance, Junction–to–Case | $R_{\theta JC}$ | 1.56 | $^\circ\text{C/W}$ |

Stresses exceeding Maximum Ratings may damage the device. Maximum Ratings are stress ratings only. Functional operation above the Recommended Operating Conditions is not implied. Extended exposure to stresses above the Recommended Operating Conditions may affect device reliability.

1. Indicates JEDEC Registered Data.



ON Semiconductor®

<http://onsemi.com>

**5 AMPERE
POWER TRANSISTORS
NPN SILICON
250 VOLTS – 80 WATTS**

MARKING DIAGRAM

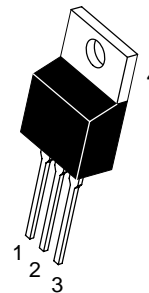

**TO-220AB
CASE 221A
STYLE 1**



2N6497 = Device Code
G = Pb–Free Package
A = Assembly Location
Y = Year
WW = Work Week

ORDERING INFORMATION

| Device | Package | Shipping |
|---------|-----------------------|-----------------|
| 2N6497 | TO-220AB | 50 Units / Rail |
| 2N6497G | TO-220AB (Pb–Free) | 50 Units / Rail |

*For additional information on our Pb–Free strategy and soldering details, please download the ON Semiconductor Soldering and Mounting Techniques Reference Manual, SOLDERRM/D.

2N6497

ELECTRICAL CHARACTERISTICS ($T_C = 25^\circ\text{C}$ unless otherwise noted) (Note 2)

| Characteristic | Symbol | Min | Typ | Max | Unit |
|--|---------------|-----------|--------|------------|---------------|
| OFF CHARACTERISTICS | | | | | |
| Collector–Emitter Sustaining Voltage (Note 3) ($I_C = 25\text{ mAdc}$, $I_B = 0$) | $V_{CE(sus)}$ | 250 | – | – | Vdc |
| Collector Cutoff Current ($V_{CE} = 350\text{ Vdc}$, $V_{BE(off)} = 1.5\text{ Vdc}$) ($V_{CE} = 175\text{ Vdc}$, $V_{BE(off)} = 1.5\text{ Vdc}$, $T_C = 100^\circ\text{C}$) | I_{CEX} | – | – | 1.0 10 | mAdc |
| Emitter Cutoff Current ($V_{BE} = 6.0\text{ Vdc}$, $I_C = 0$) | I_{EBO} | – | – | 1.0 | mAdc |
| ON CHARACTERISTICS (Note 3) | | | | | |
| DC Current Gain ($I_C = 2.5\text{ Adc}$, $V_{CE} = 10\text{ Vdc}$) ($I_C = 5.0\text{ Adc}$, $V_{CE} = 10\text{ Vdc}$) | h_{FE} | 10 3.0 | – – | 75 – | – |
| Collector–Emitter Saturation Voltage ($I_C = 2.5\text{ Adc}$, $I_B = 500\text{ mAdc}$) ($I_C = 5.0\text{ Adc}$, $I_B = 2.0\text{ Adc}$) | $V_{CE(sat)}$ | – – | – – | 1.0 5.0 | Vdc |
| Base–Emitter Saturation Voltage ($I_C = 2.5\text{ Adc}$, $I_B = 500\text{ mAdc}$) ($I_C = 5.0\text{ Adc}$, $I_B = 2.0\text{ Adc}$) | $V_{BE(sat)}$ | – – | – – | 1.5 2.5 | Vdc |
| DYNAMIC CHARACTERISTICS | | | | | |
| Current–Gain – Bandwidth Product ($I_C = 250\text{ mAdc}$, $V_{CE} = 10\text{ Vdc}$, $f = 1.0\text{ MHz}$) | f_T | 5.0 | – | – | MHz |
| Output Capacitance ($V_{CB} = 10\text{ Vdc}$, $I_E = 0$, $f = 100\text{ kHz}$) | C_{ob} | – | – | 150 | pF |
| SWITCHING CHARACTERISTICS | | | | | |
| Rise Time ($V_{CC} = 125\text{ Vdc}$, $I_C = 2.5\text{ Adc}$, $I_{B1} = 0.5\text{ Adc}$) | t_r | – | 0.4 | 1.0 | μs |
| Storage Time ($V_{CC} = 125\text{ Vdc}$, $I_C = 2.5\text{ Adc}$, $V_{BE} = 5.0\text{ Vdc}$, $I_{B1} = I_{B2} = 0.5\text{ Adc}$) | t_s | – | 1.4 | 2.5 | μs |
| Fall Time ($V_{CC} = 125\text{ Vdc}$, $I_C = 2.5\text{ Adc}$, $I_{B1} = I_{B2} = 0.5\text{ Adc}$) | t_f | – | 0.45 | 1.0 | μs |

2. Indicates JEDEC Registered Data.

3. Pulse Test: Pulse Width $\leq 300\ \mu\text{s}$, Duty Cycle $\leq 2.0\%$.

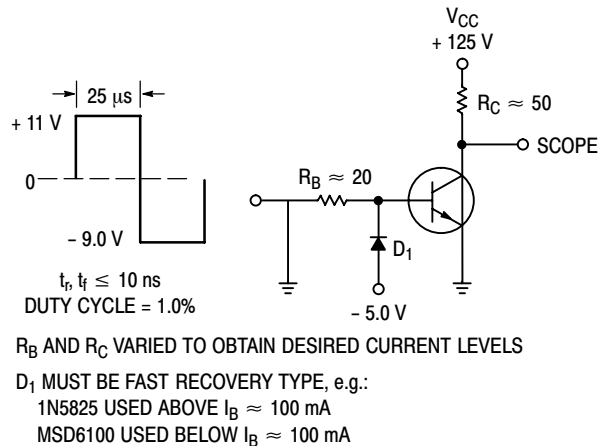

Figure 1. Switching Time Test Circuit

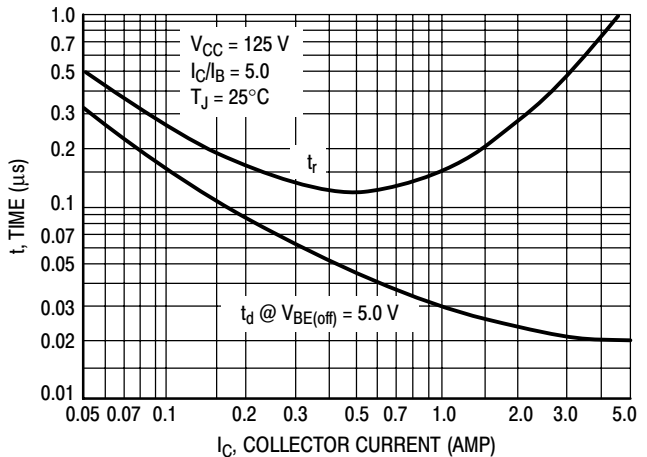

Figure 2. Turn–On Time

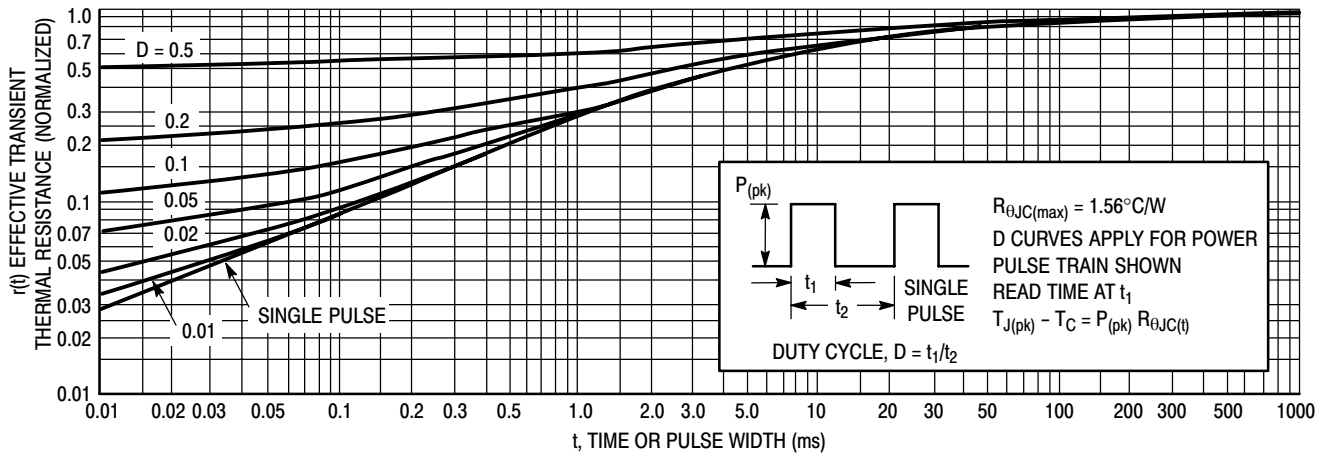

Figure 3. Thermal Response

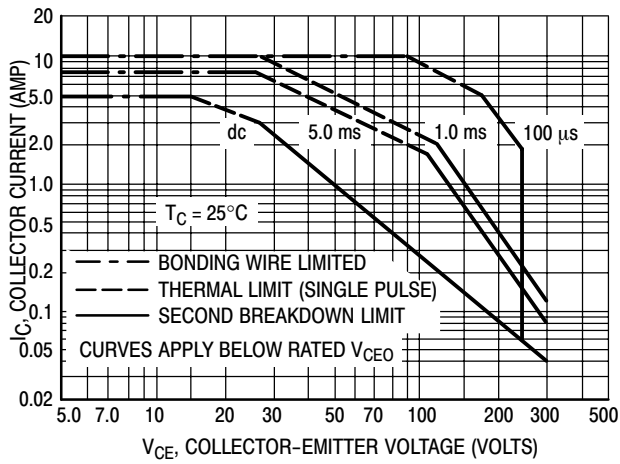

Figure 4. Active-Region Safe Operating Area

There are two limitations on the power handling ability of a transistor: average junction temperature and second breakdown. Safe operating area curves indicate $I_C - V_{CE}$ limits of the transistor that must be observed for reliable operation; i.e., the transistor must not be subjected to greater dissipation than the curves indicate.

The data of Figure 4 is based on $T_C = 25^\circ C$; $T_{J(pk)}$ is variable depending on power level. Second breakdown pulse limits are valid for duty cycles to 10% provided $T_{J(pk)} \leq 150^\circ C$. $T_{J(pk)}$ may be calculated from the data in Figure 3. At high case temperatures, thermal limitations will reduce the power that can be handled to values less than the limitations imposed by second breakdown. Second breakdown limitations do not derate the same as thermal limitations. Allowable current at the voltage shown on Figure 4 may be found at any case temperature by using the appropriate curve on Figure 6.

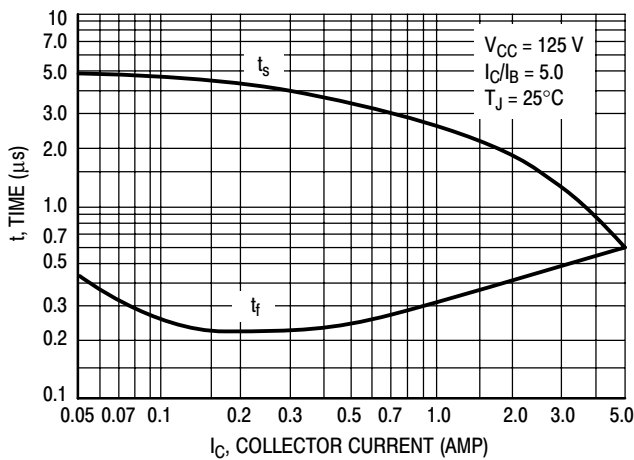

Figure 5. Turn-Off Time

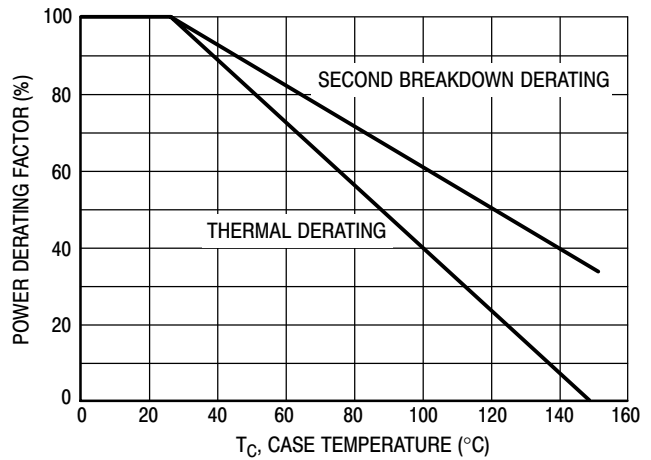

Figure 6. Power Derating

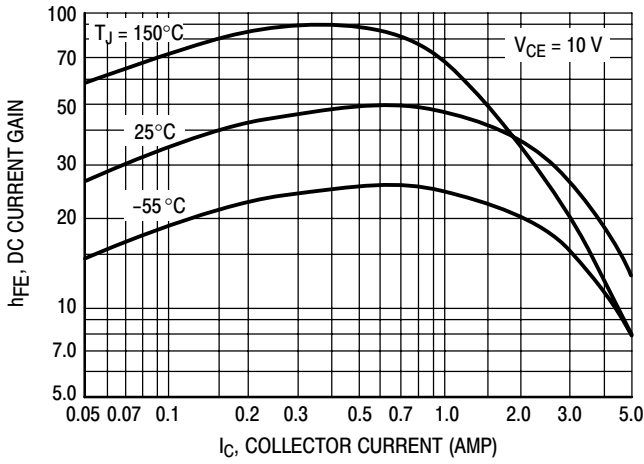

Figure 7. DC Current Gain

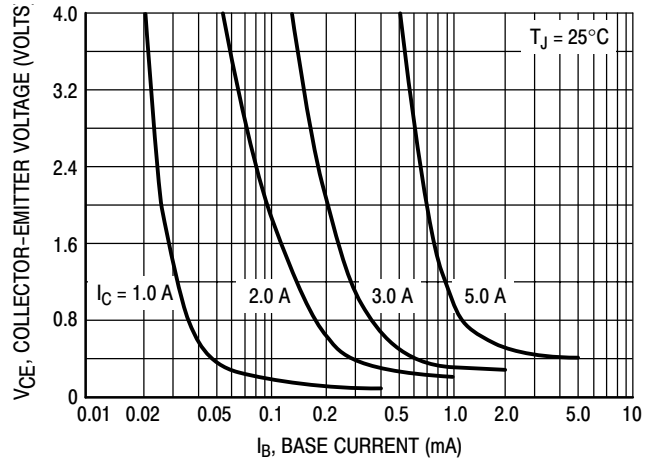

Figure 8. Collector Saturation Region

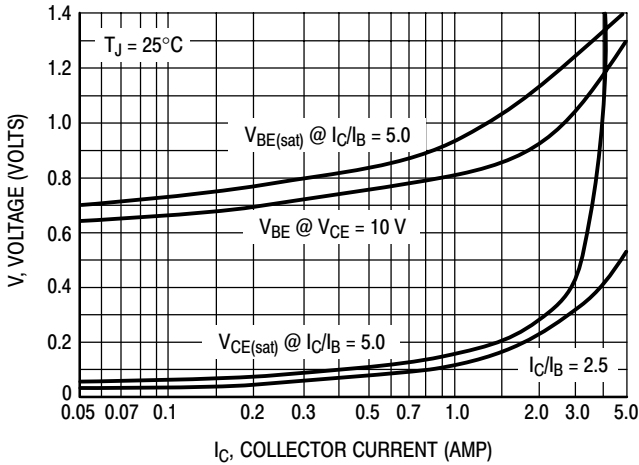

Figure 9. "On" Voltages

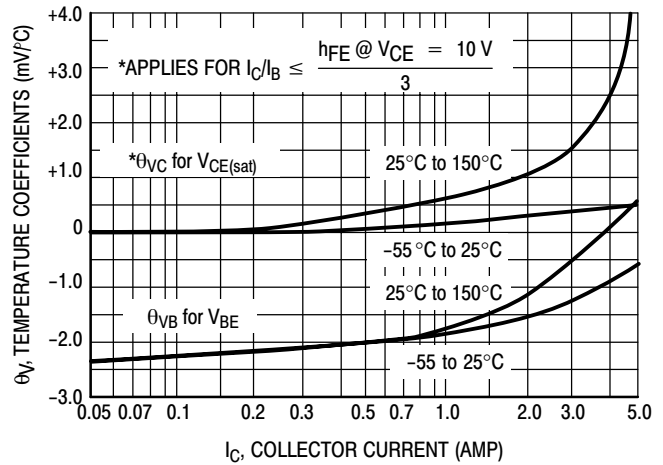

Figure 10. Temperature Coefficients

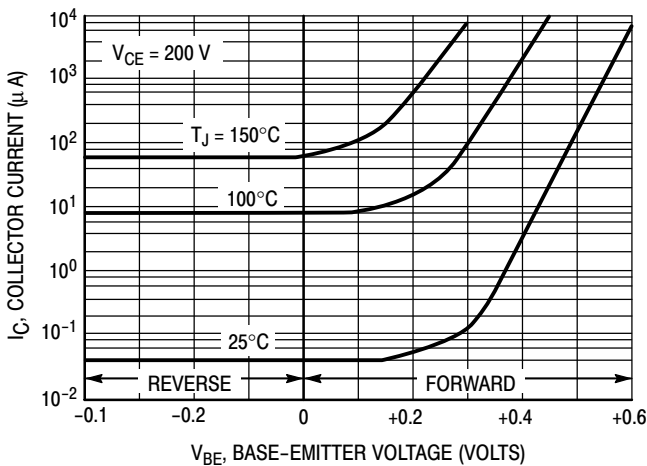

Figure 11. Collector Cutoff Region

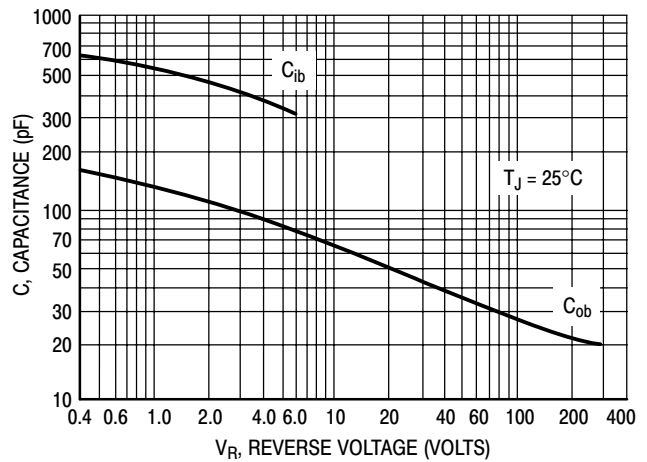

Figure 12. Capacitance

onsemi, **Onsemi**, and other names, marks, and brands are registered and/or common law trademarks of Semiconductor Components Industries, LLC dba "**onsemi**" or its affiliates and/or subsidiaries in the United States and/or other countries. **onsemi** owns the rights to a number of patents, trademarks, copyrights, trade secrets, and other intellectual property. A listing of **onsemi**'s product/patent coverage may be accessed at www.onsemi.com/site/pdf/Patent-Marking.pdf. **onsemi** reserves the right to make changes at any time to any products or information herein, without notice. The information herein is provided "as-is" and **onsemi** makes no warranty, representation or guarantee regarding the accuracy of the information, product features, availability, functionality, or suitability of its products for any particular purpose, nor does **onsemi** assume any liability arising out of the application or use of any product or circuit, and specifically disclaims any and all liability, including without limitation special, consequential or incidental damages. Buyer is responsible for its products and applications using **onsemi** products, including compliance with all laws, regulations and safety requirements or standards, regardless of any support or applications information provided by **onsemi**. "Typical" parameters which may be provided in **onsemi** data sheets and/or specifications can and do vary in different applications and actual performance may vary over time. All operating parameters, including "Typicals" must be validated for each customer application by customer's technical experts. **onsemi** does not convey any license under any of its intellectual property rights nor the rights of others. **onsemi** products are not designed, intended, or authorized for use as a critical component in life support systems or any FDA Class 3 medical devices or medical devices with a same or similar classification in a foreign jurisdiction or any devices intended for implantation in the human body. Should Buyer purchase or use **onsemi** products for any such unintended or unauthorized application, Buyer shall indemnify and hold **onsemi** and its officers, employees, subsidiaries, affiliates, and distributors harmless against all claims, costs, damages, and expenses, and reasonable attorney fees arising out of, directly or indirectly, any claim of personal injury or death associated with such unintended or unauthorized use, even if such claim alleges that **onsemi** was negligent regarding the design or manufacture of the part. **onsemi** is an Equal Opportunity/Affirmative Action Employer. This literature is subject to all applicable copyright laws and is not for resale in any manner.

ADDITIONAL INFORMATION

TECHNICAL PUBLICATIONS:

Technical Library: www.onsemi.com/design/resources/technical-documentation
onsemi Website: www.onsemi.com

ONLINE SUPPORT: www.onsemi.com/support

For additional information, please contact your local Sales Representative at www.onsemi.com/support/sales