

# 2N6284 (NPN); 2N6286, 2N6287 (PNP)

Preferred Device

## Darlington Complementary Silicon Power Transistors

These packages are designed for general-purpose amplifier and low-frequency switching applications.

### Features

- High DC Current Gain @  $I_C = 10 \text{ Adc}$  –  
 $h_{FE} = 2400 \text{ (Typ)} - 2N6284$   
 $= 4000 \text{ (Typ)} - 2N6287$
- Collector–Emitter Sustaining Voltage –  
 $V_{CEO(sus)} = 100 \text{ Vdc (Min)}$
- Monolithic Construction with Built–In Base–Emitter Shunt Resistors
- Pb–Free Packages are Available\*

### MAXIMUM RATINGS (Note 1)

Rating	Symbol	Value	Unit
Collector–Emitter Voltage	$V_{CEO}$	80 100	Vdc
Collector–Base Voltage	$V_{CB}$	80 100	Vdc
Emitter–Base Voltage	$V_{EB}$	5.0	Vdc
Collector Current – Continuous Peak	$I_C$	20 40	Adc
Base Current	$I_B$	0.5	Adc
Total Power Dissipation @ $T_C = 25^\circ\text{C}$ Derate above $25^\circ\text{C}$	$P_D$	160 0.915	W W/ $^\circ\text{C}$
Operating and Storage Temperature Range	$T_J, T_{stg}$	–65 to +200	$^\circ\text{C}$

### THERMAL CHARACTERISTICS (Note 1)

Characteristic	Symbol	Max	Unit
Thermal Resistance, Junction–to–Case	$R_{\theta JC}$	1.09	$^\circ\text{C/W}$

Stresses exceeding Maximum Ratings may damage the device. Maximum Ratings are stress ratings only. Functional operation above the Recommended Operating Conditions is not implied. Extended exposure to stresses above the Recommended Operating Conditions may affect device reliability.

1. Indicates JEDEC Registered Data.

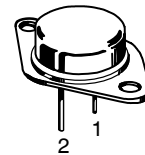
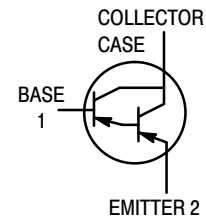
\*For additional information on our Pb–Free strategy and soldering details, please download the ON Semiconductor Soldering and Mounting Techniques Reference Manual, SOLDERRM/D.



ON Semiconductor®

<http://onsemi.com>

## 20 AMPERE COMPLEMENTARY SILICON POWER TRANSISTORS 100 VOLTS, 160 WATTS



TO–204AA (TO–3)  
CASE 1–07  
STYLE 1

### MARKING DIAGRAM

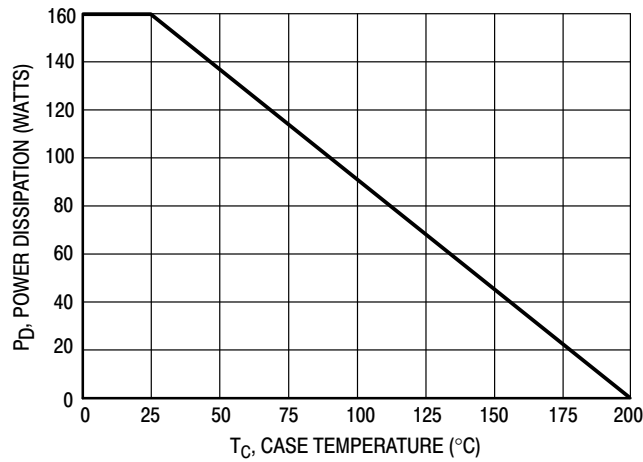


2N628x = Device Code  
x = 4, 6 or 7  
G = Pb–Free Package  
A = Location Code  
YY = Year  
WW = Work Week  
MEX = Country of Origin

### ORDERING INFORMATION

Device	Package	Shipping
2N6284	TO–3	100 Units/Tray
2N6284G	TO–3 (Pb–Free)	100 Units/Tray
2N6286	TO–3	100 Units/Tray
2N6286G	TO–3 (Pb–Free)	100 Units/Tray
2N6287	TO–3	100 Units/Tray
2N6287G	TO–3 (Pb–Free)	100 Units/Tray

## 2N6284 (NPN); 2N6286, 2N6287 (PNP)



**Figure 1. Power Derating**

### ELECTRICAL CHARACTERISTICS ( $T_C = 25^\circ\text{C}$ unless otherwise noted) (Note 2)

Characteristic	Symbol	Min	Max	Unit
<b>OFF CHARACTERISTICS</b>				
Collector–Emitter Sustaining Voltage ( $I_C = 0.1 \text{ Adc}$ , $I_B = 0$ )	$V_{CE(sus)}$	80	–	Vdc
		100	–	
				2N6286 2N6284, 2N6287
Collector Cutoff Current ( $V_{CE} = 40 \text{ Vdc}$ , $I_B = 0$ ) ( $V_{CE} = 50 \text{ Vdc}$ , $I_B = 0$ )	$I_{CEO}$	–	1.0	mAdc
		–	1.0	
Collector Cutoff Current ( $V_{CE} = \text{Rated } V_{CB}$ , $V_{BE(off)} = 1.5 \text{ Vdc}$ ) ( $V_{CE} = \text{Rated } V_{CB}$ , $V_{BE(off)} = 1.5 \text{ Vdc}$ , $T_C = 150^\circ\text{C}$ )	$I_{CEX}$	–	0.5	mAdc
		–	5.0	
Emitter Cutoff Current ( $V_{BE} = 5.0 \text{ Vdc}$ , $I_C = 0$ )	$I_{EBO}$	–	2.0	mAdc

### ON CHARACTERISTICS (Note 3)

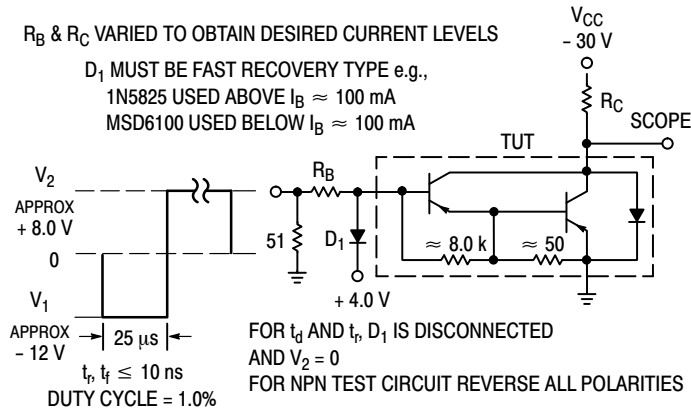
DC Current Gain ( $I_C = 10 \text{ Adc}$ , $V_{CE} = 3.0 \text{ Vdc}$ ) ( $I_C = 20 \text{ Adc}$ , $V_{CE} = 3.0 \text{ Vdc}$ )	$h_{FE}$	750	18,000	–
		100	–	
Collector–Emitter Saturation Voltage ( $I_C = 10 \text{ Adc}$ , $I_B = 40 \text{ mAdc}$ ) ( $I_C = 20 \text{ Adc}$ , $I_B = 200 \text{ mAdc}$ )	$V_{CE(sat)}$	–	2.0	Vdc
		–	3.0	
Base–Emitter On Voltage ( $I_C = 10 \text{ Adc}$ , $V_{CE} = 3.0 \text{ Vdc}$ )	$V_{BE(on)}$	–	2.8	Vdc
Base–Emitter Saturation Voltage ( $I_C = 20 \text{ Adc}$ , $I_B = 200 \text{ mAdc}$ )	$V_{BE(sat)}$	–	4.0	Vdc

### DYNAMIC CHARACTERISTICS

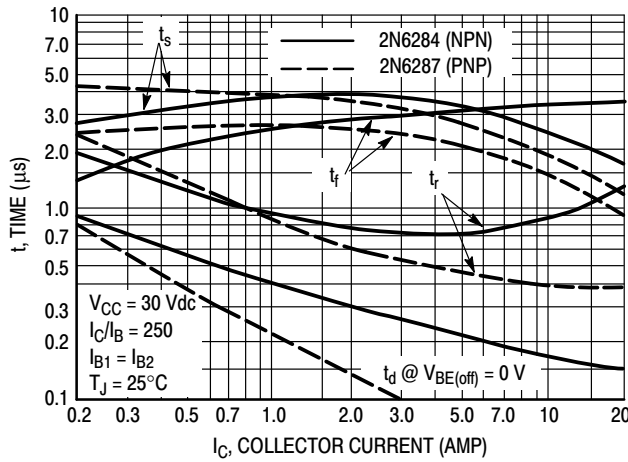
Magnitude of Common Emitter Small–Signal Short–Circuit Forward Current Transfer Ratio ( $I_C = 10 \text{ Adc}$ , $V_{CE} = 3.0 \text{ Vdc}$ , $f = 1.0 \text{ MHz}$ )	$ h_{fe} $	4.0	–	MHz
Output Capacitance ( $V_{CB} = 10 \text{ Vdc}$ , $I_E = 0$ , $f = 0.1 \text{ MHz}$ )	$C_{ob}$	–	400	pF
		–	600	
				2N6284 2N6286, 2N6287
Small–Signal Current Gain ( $I_C = 10 \text{ Adc}$ , $V_{CE} = 3.0 \text{ Vdc}$ , $f = 1.0 \text{ kHz}$ )	$h_{fe}$	300	–	–

2. Indicates JEDEC Registered Data.  
3. Pulse test: Pulse Width = 300  $\mu\text{s}$ , Duty Cycle = 2%

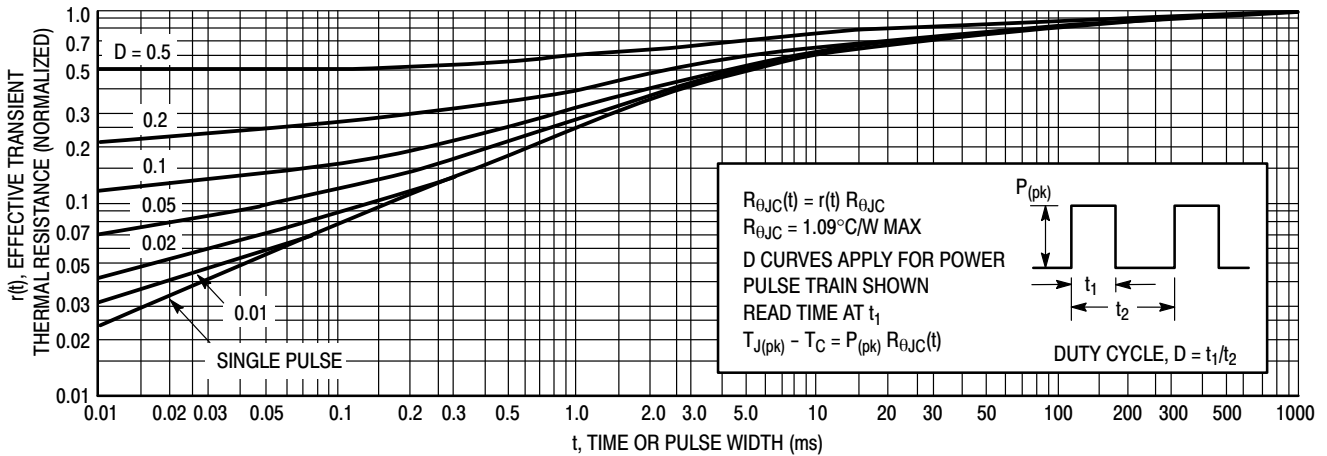
## 2N6284 (NPN); 2N6286, 2N6287 (PNP)



**Figure 2. Switching Times Test Circuit**



**Figure 3. Switching Times**



**Figure 4. Thermal Response**

## 2N6284 (NPN); 2N6286, 2N6287 (PNP)

### ACTIVE-REGION SAFE OPERATING AREA

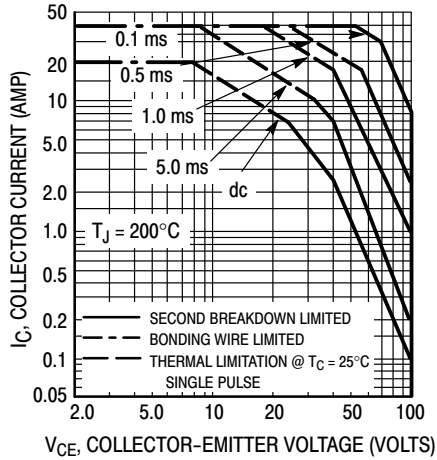


Figure 5. 2N6284, 2N6287

There are two limitations on the power handling ability of a transistor: average junction temperature and second breakdown. Safe operating area curves indicate  $I_C - V_{CE}$  limits of the transistor that must be observed for reliable operation; i.e. the transistor must not be subjected to greater dissipation than the curves indicate.

The data of Figure 5 is based on  $T_{J(pk)} = 200^\circ\text{C}$ ;  $T_C$  is variable depending on conditions. Second breakdown pulse limits are valid for duty cycles to 10% provided  $T_{J(pk)} < 200^\circ\text{C}$ .  $T_{J(pk)}$  may be calculated from the data in Figure 4. At high case temperatures, thermal limitations will reduce the power that can be handled to values less than the limitations imposed by second breakdown.

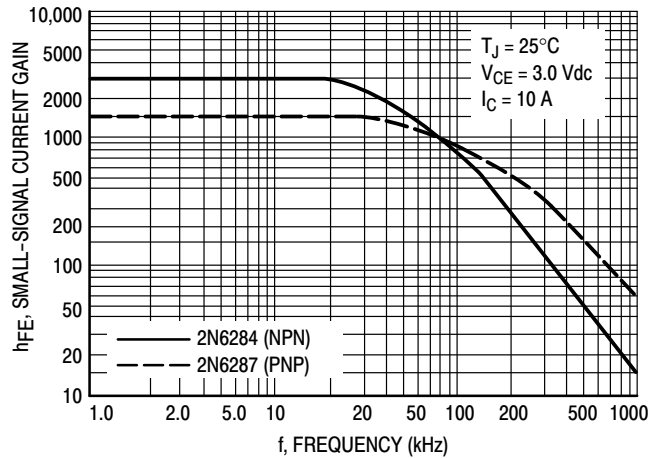


Figure 6. Small-Signal Current Gain

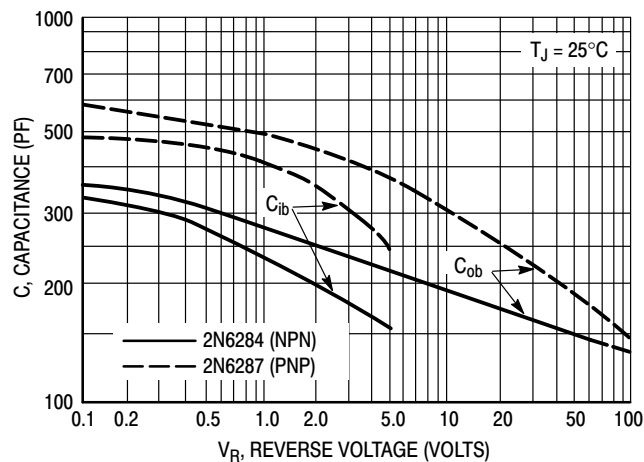
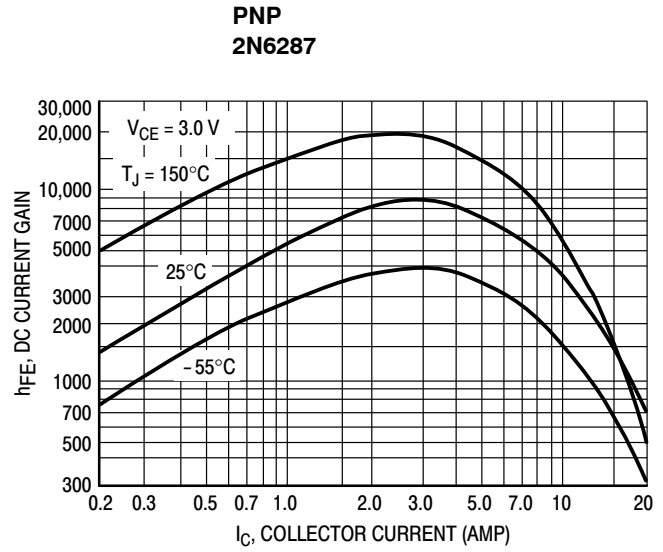
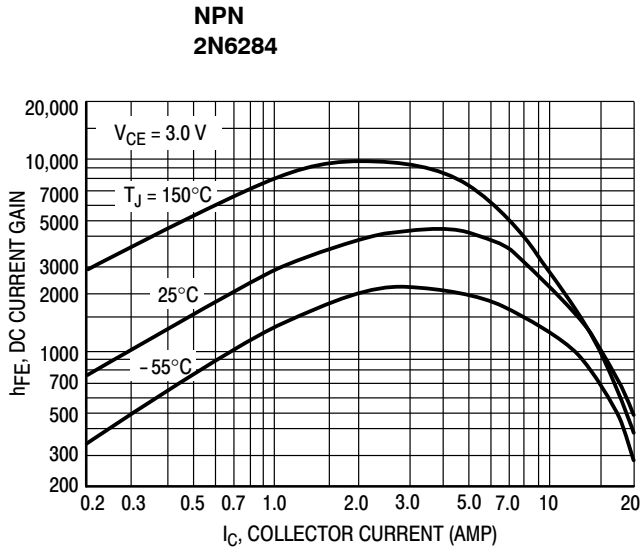
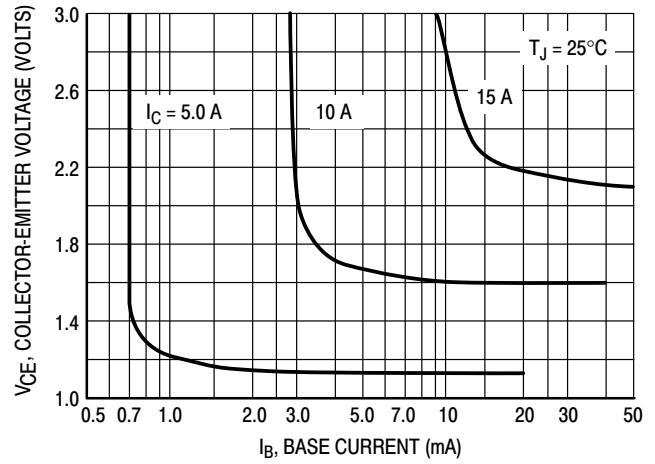
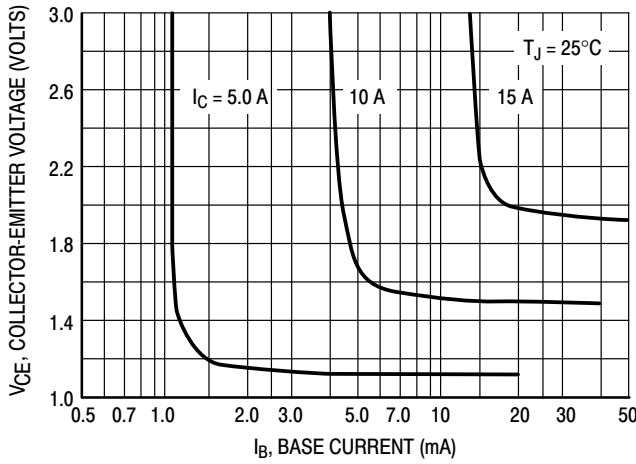


Figure 7. Capacitance

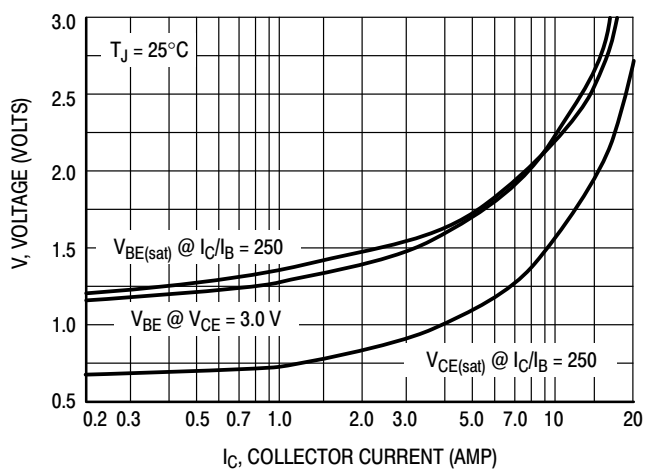
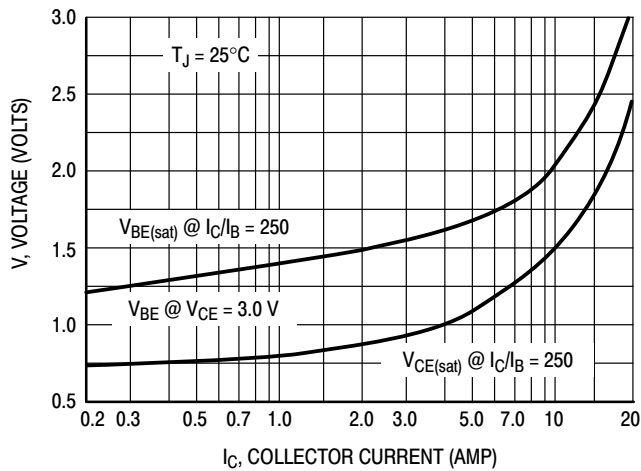
## 2N6284 (NPN); 2N6286, 2N6287 (PNP)



**Figure 8. DC Current Gain**

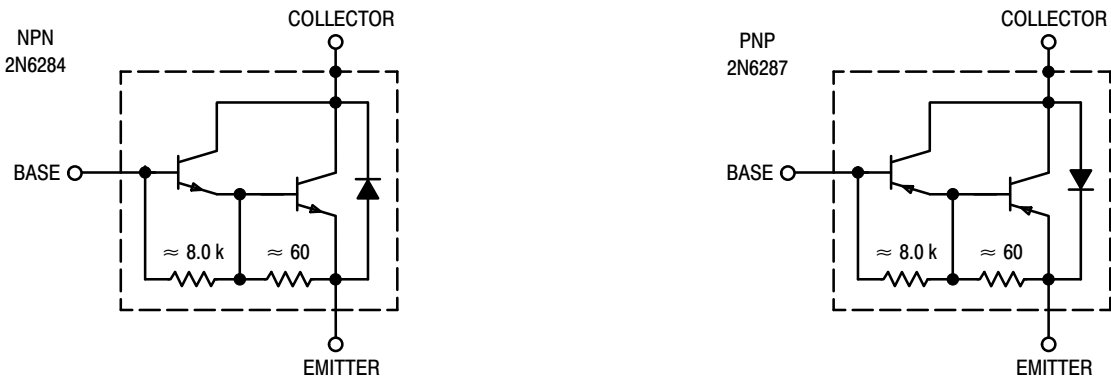
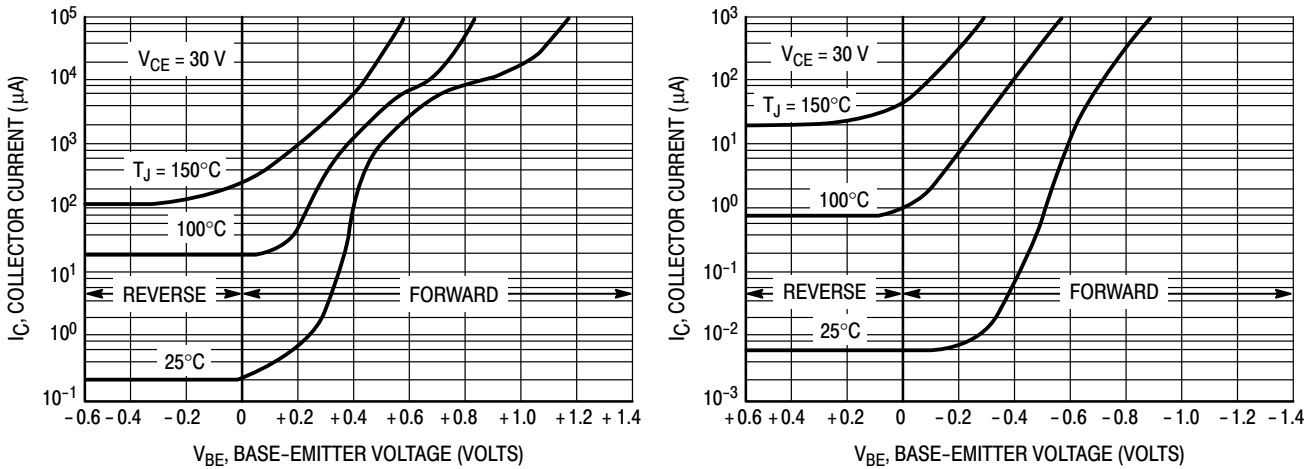
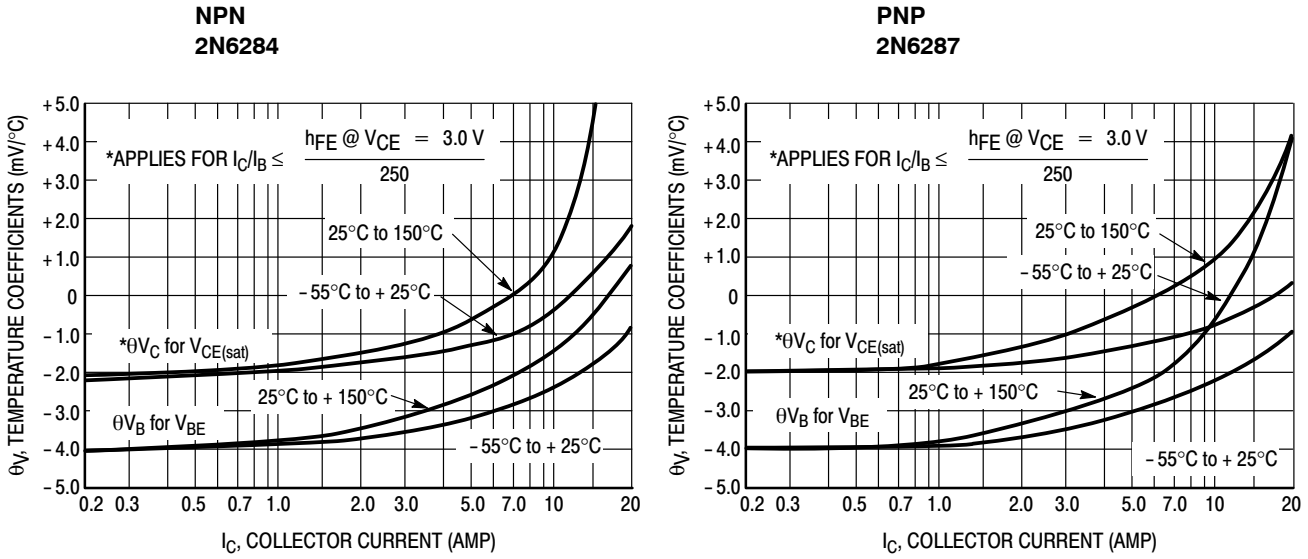


**Figure 9. Collector Saturation Region**



**Figure 10. "On" Voltages**

## 2N6284 (NPN); 2N6286, 2N6287 (PNP)



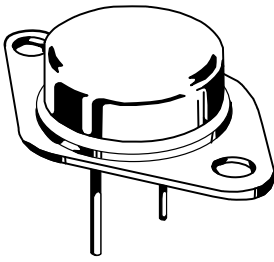
# MECHANICAL CASE OUTLINE PACKAGE DIMENSIONS

ON Semiconductor

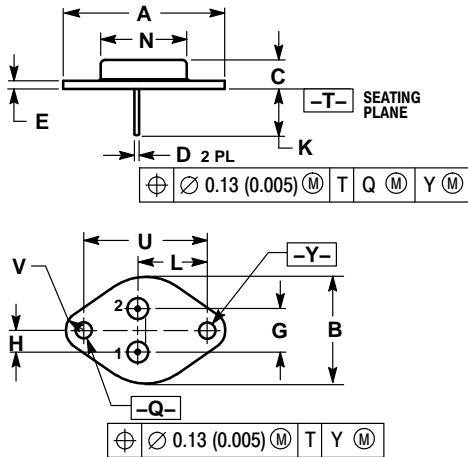


TO-204 (TO-3)  
CASE 1-07  
ISSUE Z

DATE 05/18/1988



SCALE 1:1



NOTES:

1. DIMENSIONING AND TOLERANCING PER ANSI Y14.5M, 1982.
2. CONTROLLING DIMENSION: INCH.
3. ALL RULES AND NOTES ASSOCIATED WITH REFERENCED TO-204AA OUTLINE SHALL APPLY.

DIM	INCHES		MILLIMETERS	
	MIN	MAX	MIN	MAX
A	1.550 REF	---	39.37 REF	---
B	---	1.050	---	26.67
C	0.250	0.335	6.35	8.51
D	0.038	0.043	0.97	1.09
E	0.055	0.070	1.40	1.77
G	0.430 BSC	---	10.92 BSC	---
H	0.215 BSC	---	5.46 BSC	---
K	0.440	0.480	11.18	12.19
L	---	0.665 BSC	---	16.89 BSC
N	---	0.830	---	21.08
Q	0.151	0.165	3.84	4.19
U	1.187 BSC	---	30.15 BSC	---
V	0.131	0.188	3.33	4.77

- |  |  |   |   |   |
|--|--|---|---|---|
| <p>STYLE 1:<br/>PIN 1. BASE<br/>2. EMITTER<br/>CASE: COLLECTOR</p> | <p>STYLE 2:<br/>PIN 1. BASE<br/>2. COLLECTOR<br/>CASE: EMITTER</p> | <p>STYLE 3:<br/>PIN 1. GATE<br/>2. SOURCE<br/>CASE: DRAIN</p>           | <p>STYLE 4:<br/>PIN 1. GROUND<br/>2. INPUT<br/>CASE: OUTPUT</p>       | <p>STYLE 5:<br/>PIN 1. CATHODE<br/>2. EXTERNAL TRIP/DELAY<br/>CASE: ANODE</p> |
| <p>STYLE 6:<br/>PIN 1. GATE<br/>2. EMITTER<br/>CASE: COLLECTOR</p> | <p>STYLE 7:<br/>PIN 1. ANODE<br/>2. OPEN<br/>CASE: CATHODE</p>     | <p>STYLE 8:<br/>PIN 1. CATHODE #1<br/>2. CATHODE #2<br/>CASE: ANODE</p> | <p>STYLE 9:<br/>PIN 1. ANODE #1<br/>2. ANODE #2<br/>CASE: CATHODE</p> |   |

ON Semiconductor and are trademarks of Semiconductor Components Industries, LLC (SCILLC). SCILLC reserves the right to make changes without further notice to any products herein. SCILLC makes no warranty, representation or guarantee regarding the suitability of its products for any particular purpose, nor does SCILLC assume any liability arising out of the application or use of any product or circuit, and specifically disclaims any and all liability, including without limitation special, consequential or incidental damages. "Typical" parameters which may be provided in SCILLC data sheets and/or specifications can and do vary in different applications and actual performance may vary over time. All operating parameters, including "Typicals" must be validated for each customer application by customer's technical experts. SCILLC does not convey any license under its patent rights nor the rights of others. SCILLC products are not designed, intended, or authorized for use as components in systems intended for surgical implant into the body, or other applications intended to support or sustain life, or for any other application in which the failure of the SCILLC product could create a situation where personal injury or death may occur. Should Buyer purchase or use SCILLC products for any such unintended or unauthorized application, Buyer shall indemnify and hold SCILLC and its officers, employees, subsidiaries, affiliates, and distributors harmless against all claims, costs, damages, and expenses, and reasonable attorney fees arising out of, directly or indirectly, any claim of personal injury or death associated with such unintended or unauthorized use, even if such claim alleges that SCILLC was negligent regarding the design or manufacture of the part. SCILLC is an Equal Opportunity/Affirmative Action Employer.

**onsemi**, **Onsemi**, and other names, marks, and brands are registered and/or common law trademarks of Semiconductor Components Industries, LLC dba "**onsemi**" or its affiliates and/or subsidiaries in the United States and/or other countries. **onsemi** owns the rights to a number of patents, trademarks, copyrights, trade secrets, and other intellectual property. A listing of **onsemi**'s product/patent coverage may be accessed at [www.onsemi.com/site/pdf/Patent-Marking.pdf](http://www.onsemi.com/site/pdf/Patent-Marking.pdf). **onsemi** reserves the right to make changes at any time to any products or information herein, without notice. The information herein is provided "as-is" and **onsemi** makes no warranty, representation or guarantee regarding the accuracy of the information, product features, availability, functionality, or suitability of its products for any particular purpose, nor does **onsemi** assume any liability arising out of the application or use of any product or circuit, and specifically disclaims any and all liability, including without limitation special, consequential or incidental damages. Buyer is responsible for its products and applications using **onsemi** products, including compliance with all laws, regulations and safety requirements or standards, regardless of any support or applications information provided by **onsemi**. "Typical" parameters which may be provided in **onsemi** data sheets and/or specifications can and do vary in different applications and actual performance may vary over time. All operating parameters, including "Typicals" must be validated for each customer application by customer's technical experts. **onsemi** does not convey any license under any of its intellectual property rights nor the rights of others. **onsemi** products are not designed, intended, or authorized for use as a critical component in life support systems or any FDA Class 3 medical devices or medical devices with a same or similar classification in a foreign jurisdiction or any devices intended for implantation in the human body. Should Buyer purchase or use **onsemi** products for any such unintended or unauthorized application, Buyer shall indemnify and hold **onsemi** and its officers, employees, subsidiaries, affiliates, and distributors harmless against all claims, costs, damages, and expenses, and reasonable attorney fees arising out of, directly or indirectly, any claim of personal injury or death associated with such unintended or unauthorized use, even if such claim alleges that **onsemi** was negligent regarding the design or manufacture of the part. **onsemi** is an Equal Opportunity/Affirmative Action Employer. This literature is subject to all applicable copyright laws and is not for resale in any manner.

## PUBLICATION ORDERING INFORMATION

### LITERATURE FULFILLMENT:

Email Requests to: [orderlit@onsemi.com](mailto:orderlit@onsemi.com)

**onsemi Website:** [www.onsemi.com](http://www.onsemi.com)

### TECHNICAL SUPPORT

**North American Technical Support:**  
Voice Mail: 1 800-282-9855 Toll Free USA/Canada  
Phone: 011 421 33 790 2910

**Europe, Middle East and Africa Technical Support:**

Phone: 00421 33 790 2910

For additional information, please contact your local Sales Representative