

Tape & Reel Packaging Standards

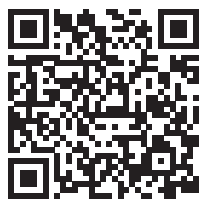

Pushing innovation to create intelligent power and sensing technologies that solve the most challenging customer problems.

onsemi[™]

[onsemi.com](https://www.onsemi.com)

Tape Reel and Reel Packaging Standards

BRD8011/D
Rev. 37, Apr 2024

© SCILLC, 2024
Previous Edition © February 2024
"All Rights Reserved"

onsemi™

onsemi, **ONSEMI**, and other names, marks, and brands are registered and/or common law trademarks of Semiconductor Components Industries, LLC dba "onsemi" or its affiliates and/or subsidiaries in the United States and/or other countries. **onsemi** owns the rights to a number of patents, trademarks, copyrights, trade secrets, and other intellectual property. A listing of **onsemi's** product/patent coverage may be accessed at www.onsemi.com/site/pdf/Patent-Marking.pdf. **onsemi** reserves the right to make changes at any time to any products or information herein, without notice. The information herein is provided "as-is" and **onsemi** makes no warranty, representation or guarantee regarding the accuracy of the information, product features, availability, functionality, or suitability of its products for any particular purpose, nor does **onsemi** assume any liability arising out of the application or use of any product or circuit, and specifically disclaims any and all liability, including without limitation special, consequential or incidental damages. Buyer is responsible for its products and applications using **onsemi** products, including compliance with all laws, regulations and safety requirements or standards, regardless of any support or applications information provided by **onsemi**. "Typical" parameters which may be provided in **onsemi** data sheets and/or specifications can and do vary in different applications and actual performance may vary over time. All operating parameters, including "Typicals" must be validated for each customer application by customer's technical experts. **onsemi** does not convey any license under any of its intellectual property rights nor the rights of others. **onsemi** products are not designed, intended, or authorized for use as a critical component in life support systems or any FDA Class 3 medical devices or medical devices with a same or similar classification in a foreign jurisdiction or any devices intended for implantation in the human body. Should Buyer purchase or use **onsemi** products for any such unintended or unauthorized application, Buyer shall indemnify and hold **onsemi** and its officers, employees, subsidiaries, affiliates, and distributors harmless against all claims, costs, damages, and expenses, and reasonable attorney fees arising out of, directly or indirectly, any claim of personal injury or death associated with such unintended or unauthorized use, even if such claim alleges that **onsemi** was negligent regarding the design or manufacture of the part. **onsemi** is an Equal Opportunity/Affirmative Action Employer. This literature is subject to all applicable copyright laws and is not for resale in any manner.

ADDITIONAL INFORMATION

TECHNICAL PUBLICATIONS

Technical Library: www.onsemi.com/design/resources/technical-documentation
onsemi Website: www.onsemi.com

ONLINE SUPPORT: www.onsemi.com/support

For additional information, please contact your local Sales Representative at
www.onsemi.com/support/sales

onsemi Tape and Reel Packaging Standards

In Brief ...

This booklet has been offered to assist those looking to coordinate packaging specifications with assembly line requirements. Additionally, dimensional and ordering information is supplied for those discrete devices that take the form of axial-leaded parts.

Table of Contents

Tape and Reel Packaging Standards.	2
onsemi Embossed Tape and Reel Listing.	3
Appendix	90
Former CMD Tape and Reel Standards by Package	96
Tape and Reel Dimensions and Orientation for Former CMD Devices	99
Standard Device Orientation	99
Product Orientation per EIA-481 Quadrant Designation	103
Reel Size	106
Reel Dimensions	106
Reel Labeling.	108
Seal Procedure	110
Embossed Carrier Tape Dimension and Specification.	111
Reel Orientation for LGA, SiP Packages	112

Tape and Reel Packaging Standards

Embossed Tape and Reel is used to facilitate automatic pick and place equipment feed requirements. The tape is used as the shipping container for various products and requires a minimum of handling. The antistatic/conductive tape provides a secure cavity for the product when sealed with the “peel-back” cover tape.

- Two Plastic(*) Reel Sizes Available (7” and 13”) (*)Except for Axial devices
- Used for Automatic Pick and Place Feed Systems
- Minimizes Product Handling
- EIA 481, -1, -2 Series

Use the standard device title and add the required suffix as listed in the option table on the following page. Note that the individual reels have a finite number of devices depending on the type of product contained in the tape. Also note the minimum lot size is one full reel for each line item, and orders are required to be in increments of the single reel quantity.

onsemi Embossed Tape and Reel Listing

- 5.1 All work areas must be in compliance with the controls described in applicable ESD control documents.
- 5.2 All rejected products must be removed from the workstation immediately and continuously.
- 5.3 All products must meet the requirements of 12MON03769D

6.0 Embossed Tape and Reel Listing

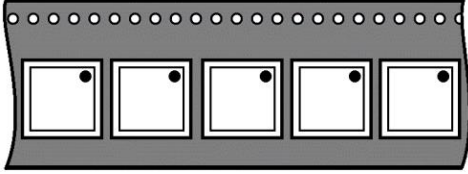
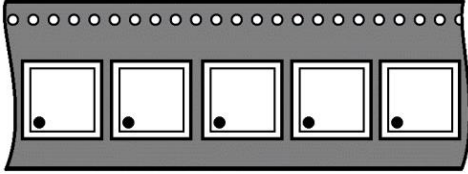
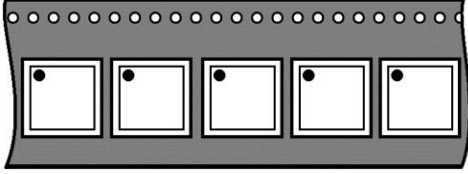
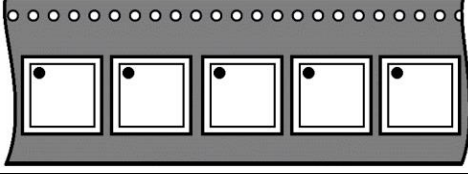
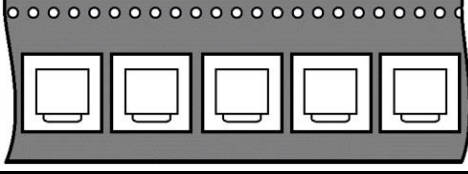
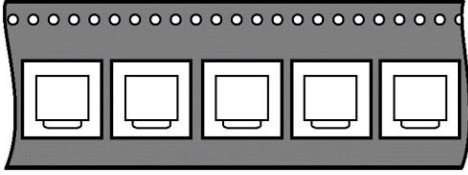
Package	Tape Width mm	Pitch mm	Component Orientation	Reel Diameter		Devices Per Reel or Min Order Quantity	TnR OPN Suffixes
				(mm)	(in)		
6-Bump (1.489 x 0.989)	8	4		178	7	3,000	T1
9-Bump (1.489 x 1.489)							
10-Bump							
ChipFET	8	4		178	7	3,000	T1
CLCC 7.5 x 5.0	12	8		178	7	1,000	TA
CUDFN ≥1.6 x 1.6 and ≤2.0 x 2.0	8	4		178	7	2,500	CUTAG
D2PAK 2 Lead	24	16		330	13	800	NA
D2PAK 3 Lead	24	16		330	13	750	R3
						800	R4
						800	T4
						700	TF4
D2PAK 5 Lead						750	R5
D2PAK 6 Lead	800	-					
	750	R7					
D2PAK 7 Lead	800	R4					

BRD8011

Package	Tape Width mm	Pitch mm	Component Orientation	Reel Diameter		Devices Per Reel or Min Order Quantity	TnR OPN Suffixes	
				(mm)	(in)			
DPAK	16	12		330	13	1,800	RL	
		8					2,500	R T4
		8					2,500	T5
DFN / QFN / WDFN 1.2 x 1.0 1.6 x 1.6 1.8 x 2.6 2.0 x 2.2 2.5 x 2.0 3.0 x 1.35 3.5 x 3.5 7.0 x 7.0	8	4		178	7	3,000	R2 T1 TB	
				330	13		3,000	TX
DFN / UDFN 2.0 x 2.0	8	4		178	7	3,000	T1 T3 R2 TB	
							1,000	R4
DFN / QFN / WDFN 2.5 x 4.5	12	8		178	7	3,000	R2	
DFN / QFN / WDFN / WQFN 3 x 3 3 x 4 3.5 x 4.5	12	8		330	13	3,000 5,000	R2 T1 TX	
				178	7		100	HTB

BRD8011

Package	Tape Width mm	Pitch mm	Component Orientation	Reel Diameter		Devices Per Reel or Min Order Quantity	TnR OPN Suffixes
				(mm)	(in)		
WQFN 3 x 2 5 x 7	8	4		178	7	3,000	TA
	12	8		178	7		TW
	12	8		330	13	3,000	TW
DFN / QFN / WDFN 3 x 3.3	12	8		330	13	2,000	T2
DFN / QFN 2.5 x 2.5 2.5 x 3.5 3.0 x 3.0 3.3 x 3.3 3.5 x 3.5 4.0 x 4.0 5.0 x 6.0	12	8		330	13	3,000 5,000	R2
							TW
						3,000	T1
						2,000	TX
DFN / QFN 3.5 x 9	12	8		330	13	2,000	TA TW
DFN / QFN 4.9 x 5.9 5 x 5 5 x 6 5.15 x 6.15	12	8		178	7	1,500	T1
				330	13	5,000	T3
DFN / QFN 4 x 4 5 x 11 6 x 5 7 x 7	12	8		330	13	2,500	TA
						2,500	TW
						4,000	
DFN 4.0 x 1.6	12	8		330	13	4,000	T4
DFN / QFN / WDFN 4 x 4	12	8		330	13	4,000	TB
						3,000	TX
						4,000	
						4,000	R2

BRD8011

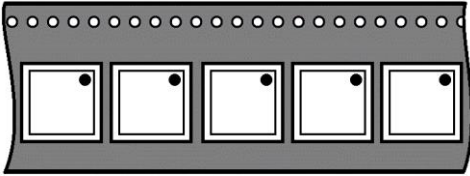
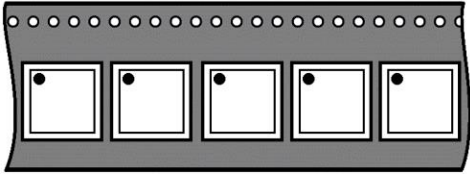
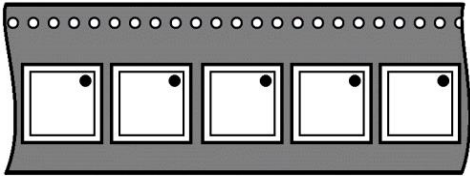
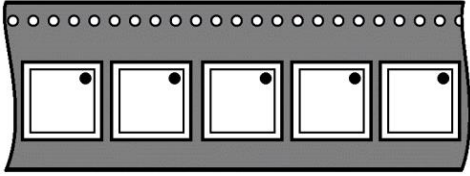
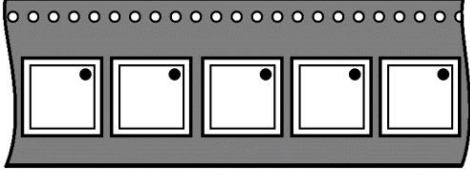
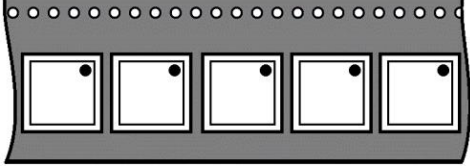
Package	Tape Width mm	Pitch mm	Component Orientation	Reel Diameter		Devices Per Reel or Min Order Quantity	TnR OPN Suffixes
				(mm)	(in)		
DFN / QFN 4 x 4 5 x 5 5 x 6 6 x 5 6 x 6	12	8		178	7	500	TB
						1,000	
				330	13	1,500	TX
						2,500	
						3,000	
						3,500	
						4,000	
5,000							
DFN / QFN 7 x 7	16	12		178	7	750	TB
				330	13	2,500	TX
DFN / QFN 8 x 8	16	12		178	7	-	TB
				330	13	2,000	TX
DFNW 3 x 3	12	8		330	13	3,000	TA
						5,000	
QFN 9 x 9	16	12		330	13	1,000	TX
QFN 10.5 x 5.20	16	12		330	13	1,000	-
QFN 13 x 10	24	16		330	13	2,000	TX
GAQFN 4.5 x 4.5 7 x 7	16	12		330	13	1,000	-
						4,000	
						2,500	

BRD8011

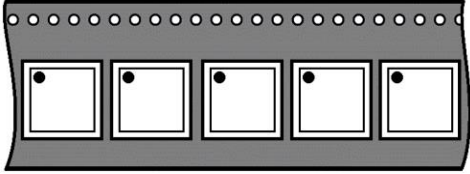
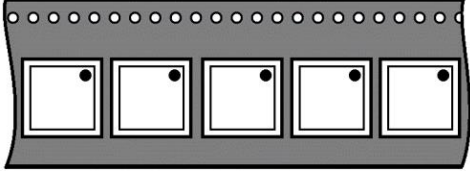
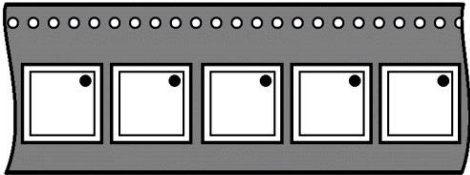
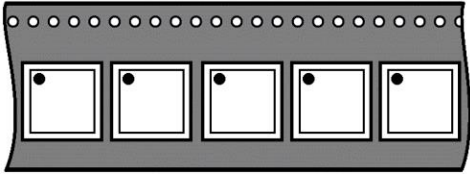
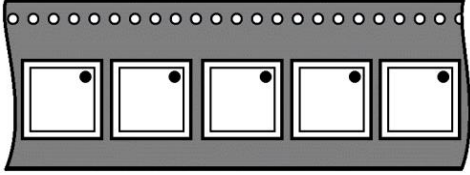
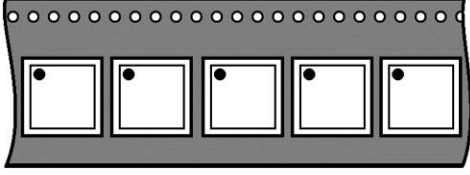
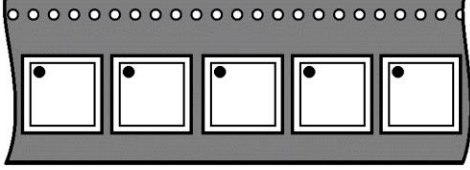
Package	Tape Width mm	Pitch mm	Component Orientation	Reel Diameter		Devices Per Reel or Min Order Quantity	TnR OPN Suffixes
				(mm)	(in)		
DO-41	79	5	No Available Component Orientation (TBD)	356	-	5,000	RL
FCBGA-16	12	8		330	13	2,500	TW
FCBGA-49	16	12					
FCBGA-81	24	12					
Flip-Chip	8	4		178	7	3,000	T1
LFBGA-56	12	8	No Available Component Orientation (TBD)	330	13	1,500	NA
LFBGA-114	24	8	No Available Component Orientation (TBD)	330	13	1,500	NA
LFBGA 11 x 11	24	16		330	13	1,000	TX
LLGA / TLLGA/ UQFN / UDFN 1.7 x 2.0 2.0 x 2.0 3.0 x 2.5 4.0 x 2.0	8	4		178	7	3,000	TA
							TB
UQFN 1.4 x 1.8	16	12		330	13	1,000	TW
UQFN 2.5 x 2.5	8	4		330	13	3,000	TW

BRD8011

Package	Tape Width mm	Pitch mm	Component Orientation	Reel Diameter		Devices Per Reel or Min Order Quantity	TnR OPN Suffixes		
				(mm)	(in)				
LFCSP 5.0 x 5.0	12	8		330	13	5,000	TX		
LLGA / TLLGA / UQFN / UDFN 3.0 x 3.0	8	4		330	13	3,000	TX		
LQFP 7 x 7	16	12		178	7	500	R2		
LQFP 10 x 10	24	16		330	13	2,000			
Micro8™ / MSOP8	12	8		178	7	1,000	R4		
				330	13	2,500	T		
						4,000	R2		
Micro10 / MSOP10	12	8	330	13	4,000	R2			
Micro8 / MSOP8	12	8		178	7	1,000	T7		
				330	13	3,000			
MSOP10 / Mirco10	12	8		178	7	1,000	(NA)		
				330	13	3,000			
PLCC-20	16	12		330	13	1,000	R2		
PLCC-28	24	16				500	R2		
PLCC-32	24	16					NA		
PLCC-44	32	24				550	R2		
PLCC-52	32	24							
PLCC-68	44	32				250	R2		
PLCC-84	44	36				330	13	250	R2
PowerFLEX™	12	24					330	13	2,000
			T4						
			R3						
			R4						
			R5						

BRD8011

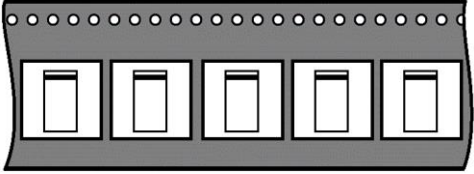
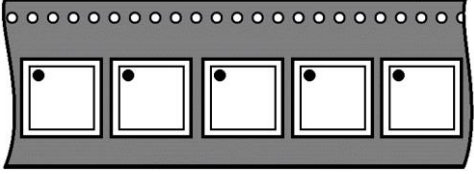
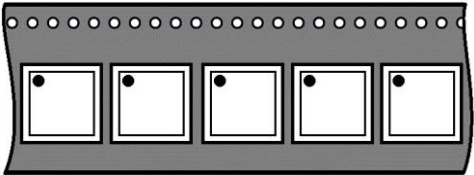
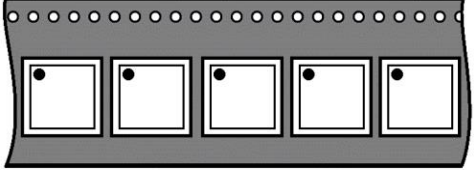
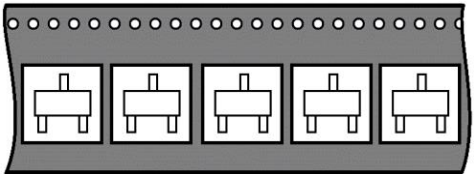
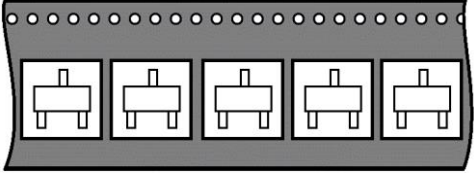
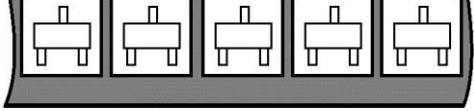
Package	Tape Width mm	Pitch mm	Component Orientation	Reel Diameter		Devices Per Reel or Min Order Quantity	TnR OPN Suffixes
				(mm)	(in)		
POWERMITE®	12	4		178	7	3,000	T1
				330	13	12,000	TR7
	16	12		330	13	1,500	(NA)
						3,000	TW
8 x 8 26L	16	12					
QSOP 16	12	8	No Available Component Orientation (TBD)	178	7	1,000	(NA)
330				13	2,500		
QSOP 20	16	8		330	13	2,500	(NA)
QSOP 24	16	8		178	7	1,000	(NA)
				330	13	2,500	
QSOP 28	16	8	No Available Component Orientation (TBD)	330	13	2,500	(NA)
SC-59	8	4		178	7	3,000	T1
				330	13	10,000	T3
				178	7	3,000	T2
SC-70	8	4		178	7	3,000	T1
				330	13	10,000	T3
SC-70FL	8	4		178	7	3,000	T1



BRD8011

Package	Tape Width mm	Pitch mm	Component Orientation	Reel Diameter		Devices Per Reel or Min Order Quantity	TnR OPN Suffixes
				(mm)	(in)		
SC-70 4 Lead / SC-82 / SC-82AB / SOT-343	8	4		178	7	3,000	NA
SC-70 5 Lead / SC-88 / SOT-353 / SOT-363	8	4		178	7	3,000	T1
				330	13	10,000	T3
				178	7	3,000	T2
				330	13	10,000	T4
SC-70 6 Lead / SC-88 / SOT-363	8	4		178	7	3,000	T1
				330	13	10,000	T3
				178	7	3,000	T2
				330	13	10,000	T4
SC-74 / SC74A / TSOP6 / TSOP5	8	4		178	7	3,000	T1
							T2
SC-74R	8	4		178	7	3,000	T1

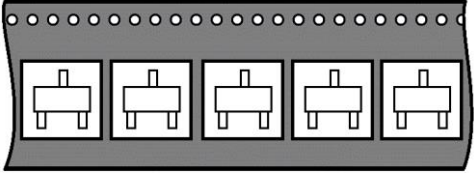
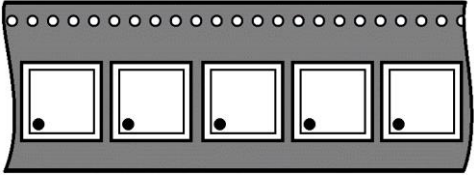
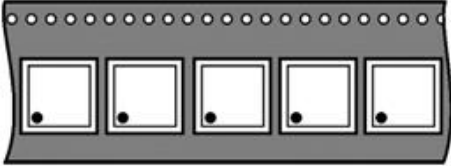
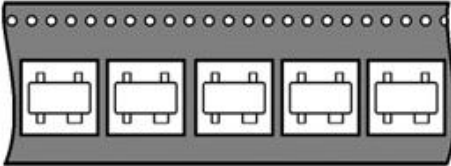
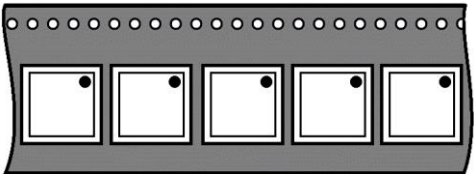
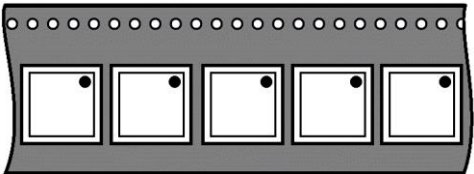
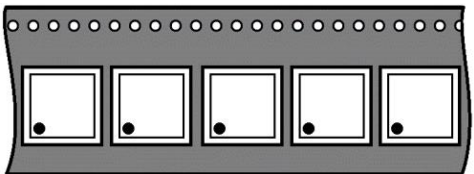
BRD8011

Package	Tape Width mm	Pitch mm	Component Orientation	Reel Diameter		Devices Per Reel or Min Order Quantity	TnR OPN Suffixes
				(mm)	(in)		
SC-75	8	4		178	7	3,000	T1
SC-82 / SOT-343	8	4		178	7	3,000	TR
						10,000	
SC-82AB / SOT-343	8	4		178	7	3,000	T1
			OR 				
SC-82FL	8	4		178	7	3,000	T1
SC-88FL	8	4		178	7	3,000	T1
SC-88AFL	8	4		178	7	3,000	T1

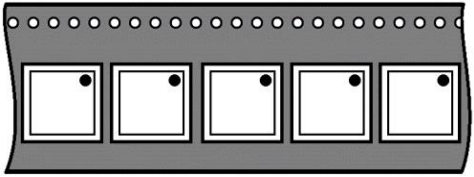
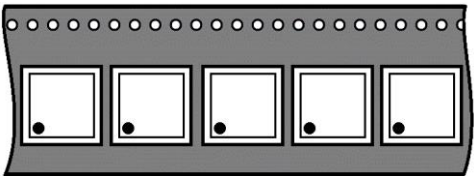
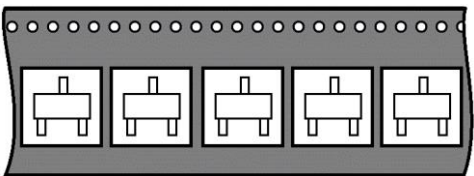
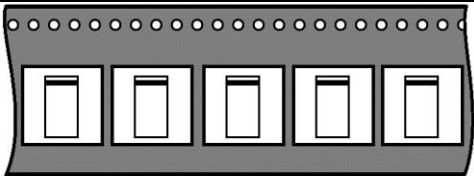
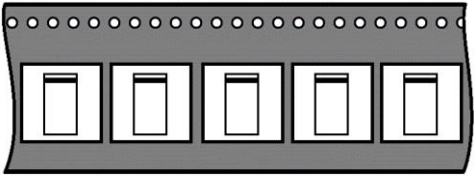
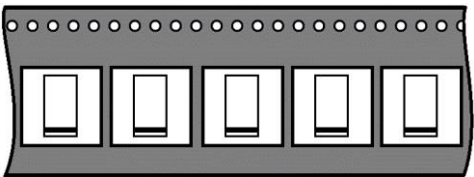
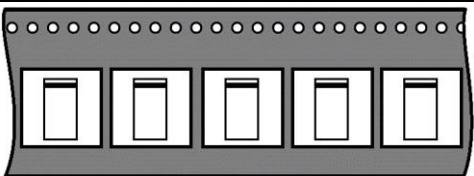
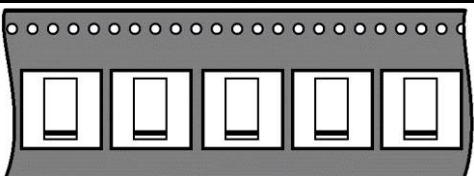
BRD8011

Package	Tape Width mm	Pitch mm	Component Orientation	Reel Diameter		Devices Per Reel or Min Order Quantity	TnR OPN Suffixes
				(mm)	(in)		
SC-88A	8	4		178	7	3,000	T1
				330	13	10,000	T3
				178	7	3,000	T2
				330	13	10,000	T4
SC-89	8	4		178	7	3,000	T1
				330	13	10,000	T3
SMA / SMAFL	12	4		330	7	5,000	T3
SMB	12	8		330	13	2,500	T3
SMC	16	8					
SOD-123	8	4		178	7	3,000	T1
	8	4		330	13	10,000	T3
	8	4		178	7	3,000	T2
SOD-123FL	8	4		178	7	3,000	T1
				330	13	10,000	T3
SOD-323	8	4		178	7	3,000	T1
				330	13	10,000	T3
		4		178	7	3,000	T1
				330	13	10,000	T3

BRD8011

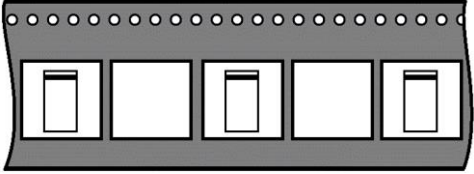
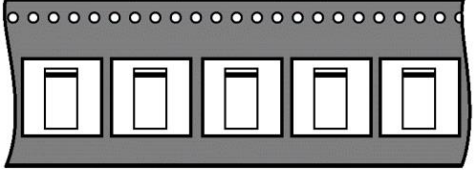
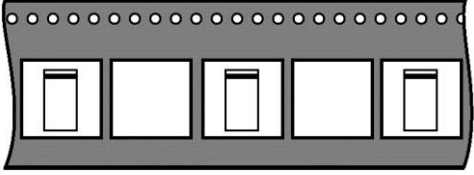
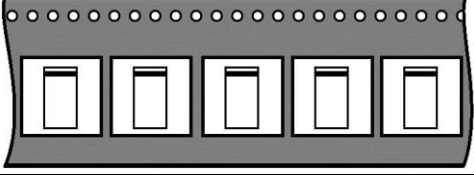
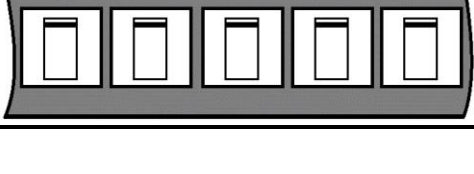
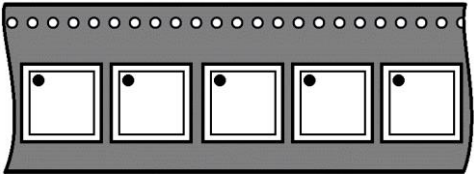
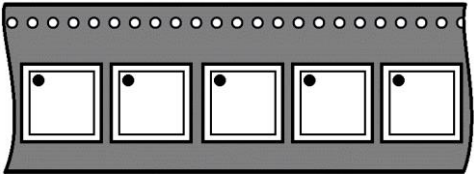
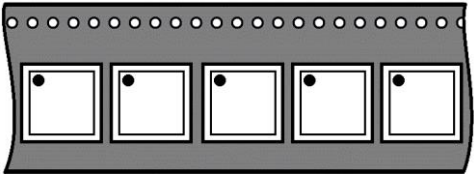
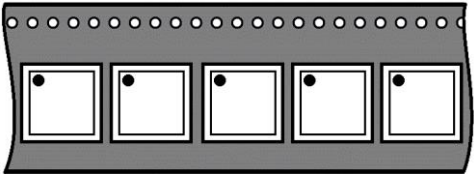
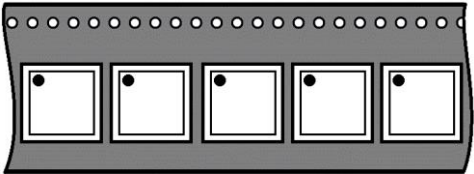
Package	Tape Width mm	Pitch mm	Component Orientation	Reel Diameter		Devices Per Reel or Min Order Quantity	TnR OPN Suffixes
				(mm)	(in)		
SOD-523	8	4		178	7	3,000	T1
		2					
SOD-723	8	4		178	7	4,000	T1
	8	2					
SOD-923	8	2		178	7	8,000	T5
SOEIAJ 8	16	16		330	13	2,000	NA
SOEIAJ14	16	16				2,000	EL
SOEIAJ16	16	16				2,000	EL
SOEIAJ20	24	24		330	13	2,000	EL
SOEIAJ24	24	24				1,000	NA
SOEIAJ28	24	24				500	NA
SOIC 8 / SONB 8 / SOIC NB 8/10 / SOIC 10 / SONB 10	12	8			178	7	2,500
SOIC WB 8	16	12		330	13	2,500	R2
				178	7	3,000	TA
SOIC 14 / SOIC NB 14 / SONB 14	16	8		330	13	1,000	TW
				178	7	2,500	R1
SOIC 16 / SOIC NB 16 / SONB 16	16	8		330	13	2,500	R2
				178	7	2,500	R1
				330	13	2,500	R2
				178	7	3,000	TA

BRD8011

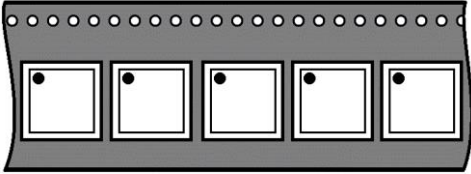
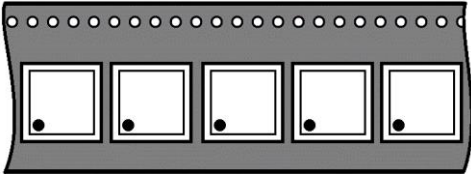
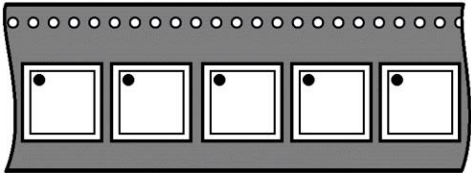
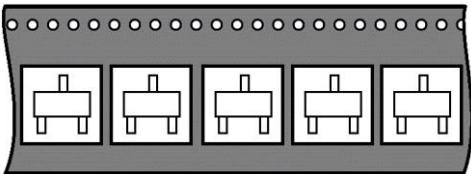
Package	Tape Width mm	Pitch mm	Component Orientation	Reel Diameter		Devices Per Reel or Min Order Quantity	TnR OPN Suffixes
				(mm)	(in)		
SOIC WB 16 (SOIC 16W / SOWB 16)	16	12		330	13	1,000	R2 R16
SOIC WB 18 (SOIC 18W / SOWB 18)	24	12		330	13	1,000	R2
SOIC WB 18 (SOIC 18W / SOWB 18)	24	16		330	13	1,000	
SOIC WB 20 (SOIC 20W / SOWB 20)	24	12		330	13	1,000	
SOIC WB 24 (SOIC 24W / SOWB 24)	24	12		330	13	1,000	
SOIC WB 28 (SOIC 28W / SOWB 28)	24	12		330	13	1,000	
SOIC WB 28 (SOIC 28W / SOWB 28)	32	12		330	13	1,000	
SOIC WB 32 (SOIC 32W / SOWB 32)	32	12		330	13	1,000	
SON-6 / SOIC-6	8	4		178	7	3,000	T1
SON-8	8	4	No Available Component Orientation (TBD)	178	7	3,000	T1
SOP-16	16	8		330	13	2,500	R2
SOT-23	8	4		178	7	3,000	T1
				330	13	10,000	T3

BRD8011

Package	Tape Width mm	Pitch mm	Component Orientation	Reel Diameter		Devices Per Reel or Min Order Quantity	TnR OPN Suffixes
				(mm)	(in)		
SOT-23 5 Lead / SC-74A / TSOP5	8	4		178	7	3,000	T1
				330	13	10,000	T3
				178	7	3,000	T2
SOT-23 6 Lead / SC-74 / TSOP6	8	4		178	7	3,000	T1
SOT-28FL	8	4		178	7	3,000	T1
SOT-89	12	8		178	7	1,000	T1
							R1
							T2

BRD8011

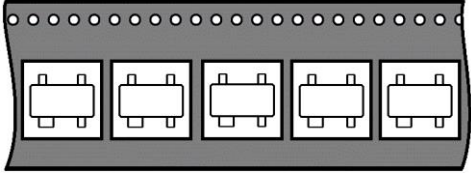
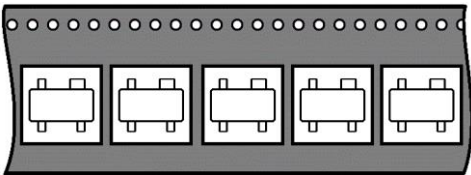
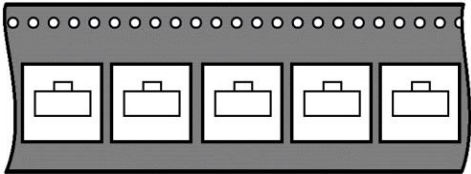
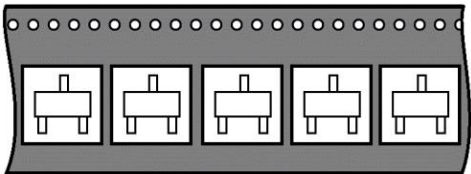
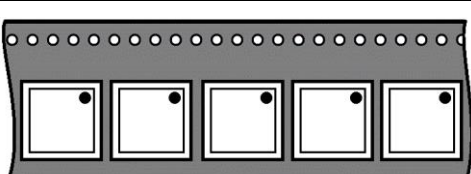
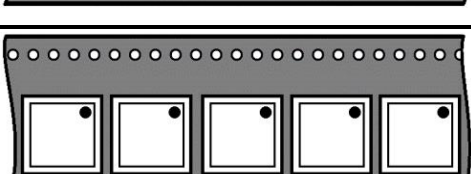
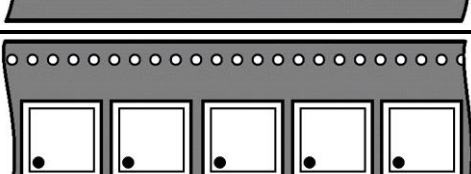
Package	Tape Width mm	Pitch mm	Component Orientation	Reel Diameter		Devices Per Reel or Min Order Quantity	TnR OPN Suffixes
				(mm)	(in)		
SOT-143	8	4		178	7	3,000	T1
				330	13	10,000	T3
				178	7	3,000	T2
				330	13	10,000	T4
SOT-223	12	8		178	7	1,000	T1
				330	13	2,500	R3 T3
				330	13	4,000	T3
SOT-323	8	4		178	7	3,000	T1
				330	13	10,000	T3
SOT-383FL	8	4		178	7	3,000	T1
SOT-553	8	4		178	7	4,000	T1
							

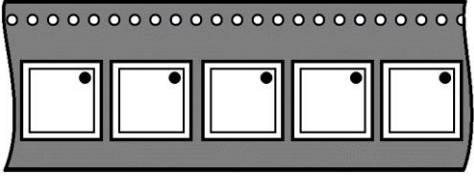
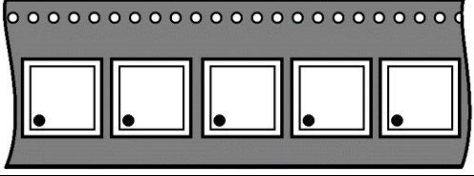
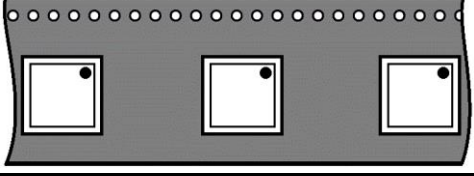
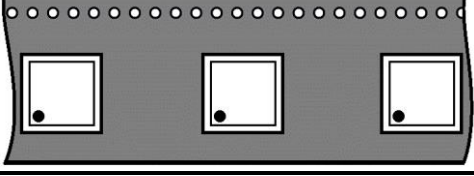
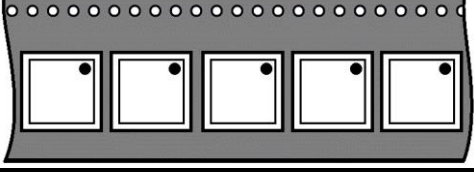
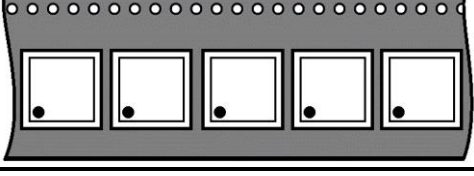
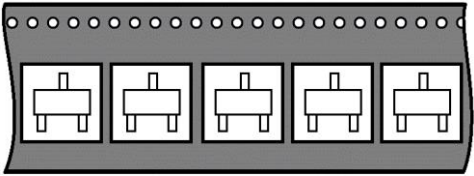

BRD8011

Package	Tape Width mm	Pitch mm	Component Orientation	Reel Diameter		Devices Per Reel or Min Order Quantity	TnR OPN Suffixes
				(mm)	(in)		
SOT-553	8	2		178	7	8,000	T5
							T6
SOT-563	8	2		178	7	4,000	T1
							T2
	8	2		178	7	8,000	T5
							T6
SOT-623	8	2		178	7	8,000	T3

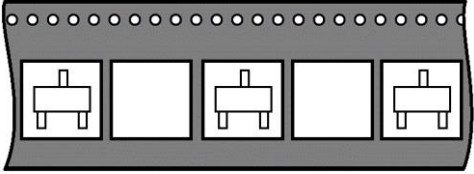
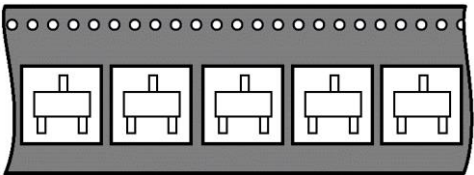
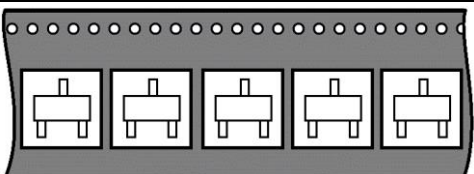
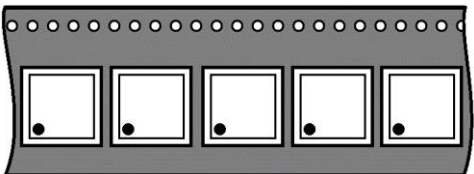
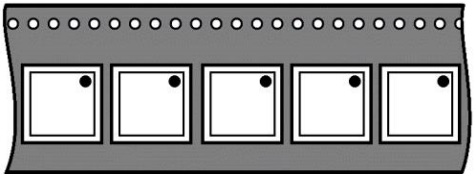
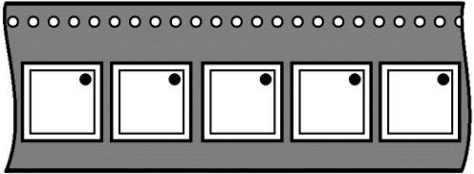
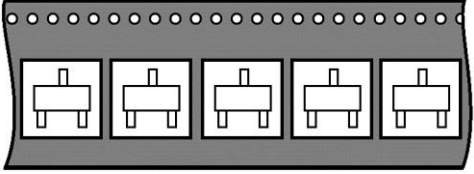
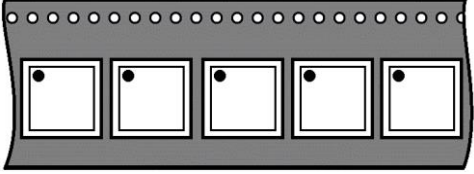
BRD8011

Package	Tape Width mm	Pitch mm	Component Orientation	Reel Diameter		Devices Per Reel or Min Order Quantity	TnR OPN Suffixes
				(mm)	(in)		
SOT-723	8	4		178	7	4,000	T1
		2				8,000	T5
	8	2		330	13	40,000	T3
SOT-883	8	2		178	7	8,000	T5
SOT-953 5 Lead	8	2		178	7	8,000	T5
SOT-963 6 Lead	8	2		178	7	8,000	T5
SO-1123	8	2		178	7	8,000	T5
						10,000	T3
SSOP-8	12	8		330	13	3,000	T1
SSOP-14	16	12				2,000	R14
SSOP-16	16	12				1,000	R16
SSOP-20	16	12				1,500	NA

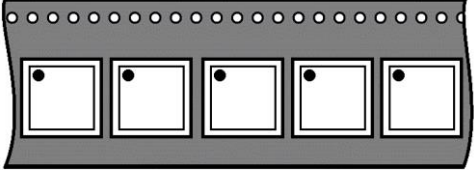
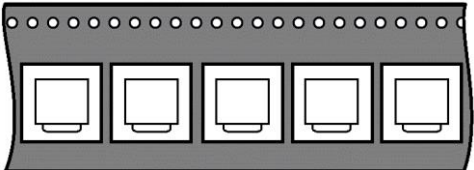
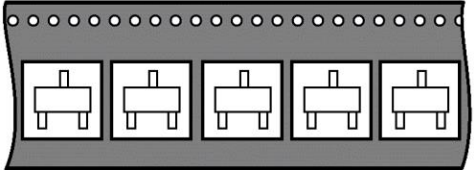
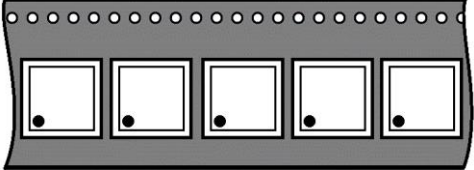
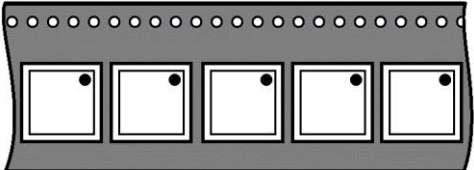
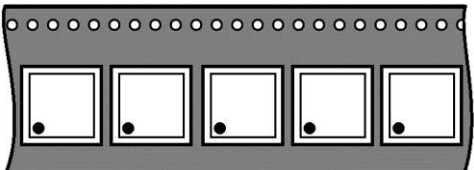
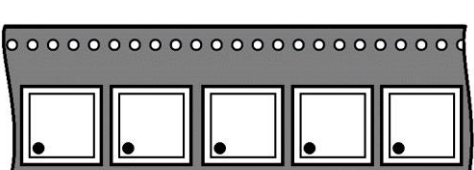
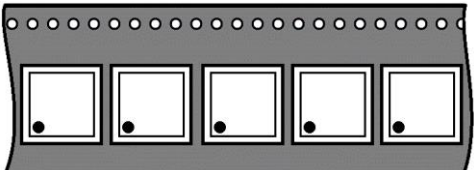
BRD8011

Package	Tape Width mm	Pitch mm	Component Orientation	Reel Diameter		Devices Per Reel or Min Order Quantity	TnR OPN Suffixes
				(mm)	(in)		
SSOP-24 NB	16	8		330	13	2,500	R2
SSOP-24 Wide	16	12				2,000	R24
	16	8				2,500	R2
SSOP-28	16	12				1,500	NA
SSOP-48	32	16				1,000	NA
SPAK-7 Lead	24	12		330	13	2,000	T1
TO-227-3L 4.45 x 6.15	12	4		330	13	5,000 6,000	T3
THIN SOT-6 / TSOT-23 6L	8	4		178	7	2,500	NA
TQFP-32	16	12		330	13	2,000	R2
TQFP-48	16	12				1,500	NA
TQFP-52	24	16				1,500	R2
TQFP-64	24	16				1,500	R2
TSOP-5 / SC-74A / SOT-23 5L	8	4		178	7	3,000	T1
				330	13	10,000	T3
TSOP-6 / SC-74 / SOT-23 6L	8	4		178	7	3,000	T1
				330	13	10,000	T3

BRD8011

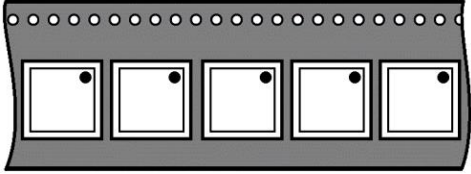
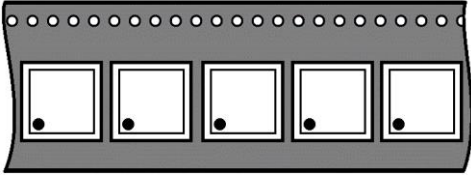
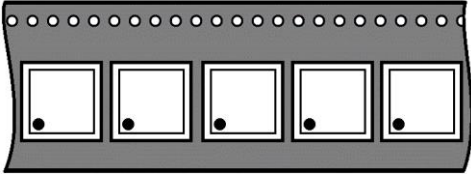
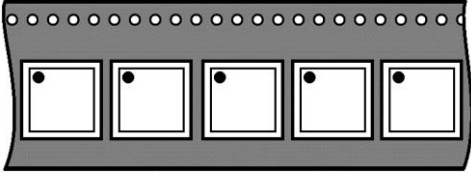
Package	Tape Width mm	Pitch mm	Component Orientation	Reel Diameter		Devices Per Reel or Min Order Quantity	TnR OPN Suffixes
				(mm)	(in)		
TSOP-28	24	12		330	13	500	(NA)
TSOP-32	32	16				500	
TSOT-23 5L	8	4		178	7	3,000	(NA)
				330	13	10,000	
TSOT-23 6L	8	4		178	7	3,000	(NA)
				330	13	10,000	
TSSOP-8	12	8		330	13	2,500	R2
		4,000					
		3,000				R3	
						TU	
TSSOP-10	12	8				2,500	R2
TSSOP-14	12	8				2,500	R2
TSSOP-16	12	8				2,500	R2
						4,000	R2
TSSOP-20	16	8				2,500	R2
TSSOP-24	16	8				2,500	R2
TSSOP-28	16	8				2,500	NA
						4,000	R2
TSSOP-38	16	8				2,500	R2
TSSOP-38 EP	16	8				2,500	R2
TSSOP-48	24	12				1,000	R2
			2,500	R2			
TSSOP-56	24	12	1,000	R2			
			1,500	R2			
TSSOP-64	24	12	1,500	NA			

BRD8011

Package	Tape Width mm	Pitch mm	Component Orientation	Reel Diameter		Devices Per Reel or Min Order Quantity	TnR OPN Suffixes
				(mm)	(in)		
U8FL	12	8		178	7	1,500	TA
				330	13	5,000	TW
				178	7	1,500	TB
				330	13	5,000	TX
UDFN 1.8 x 1.2 2.5 x 1.2 3.2 x 2.4 3.5 x 1.2	8	4		178	7	3,000	T2
UDFN 5.5 x 1.5	12	4					TA
UDFN 1.2 x 1.0 1.0 x 1.0	8	2					TC
UDFN2 1.6 x 1.0	8	2		178	7	8,000	T5
UDFN2 1.0 x 0.6	8	2		178	7	8,000	T5

BRD8011

Package	Tape Width mm	Pitch mm	Component Orientation	Reel Diameter		Devices Per Reel or Min Order Quantity	TnR OPN Suffixes
				(mm)	(in)		
UDFN 6	8	4		178	7	3,000 5,000	TC
						3,000 5,000	TB
ULLGA 1.0 x 1.0 1.2 x 1.0 1.45 x 1.0 1.6 x 1.0 1.95 x 1.0	8	2		178	7	3,000	TC
US8	8	4		178	7	3,000	T1
				330	13	10,000	T3
				330	13	5,000	TW
WDFN 4L 1 x 1.2	8	4		178	7	3,000	NA
WDFN / UDFN 1.8 x 2.6	8	4		178	7	3,000	R2

BRD8011

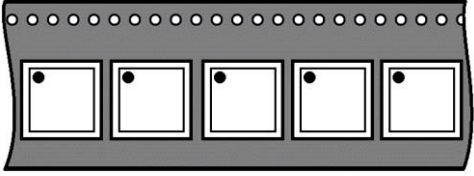
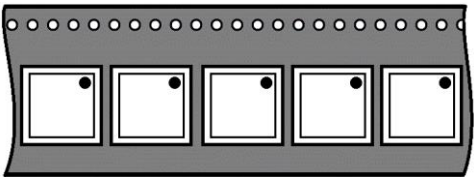
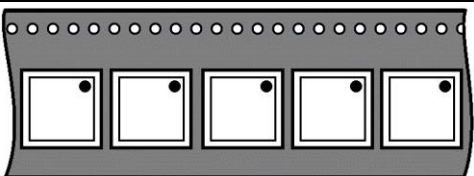
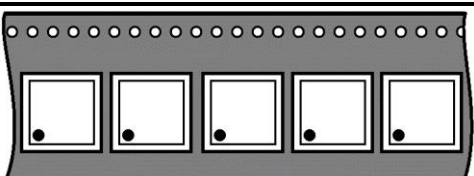
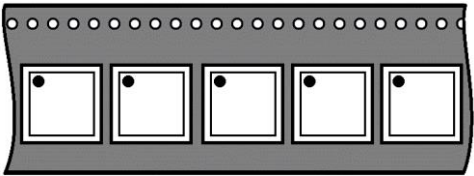
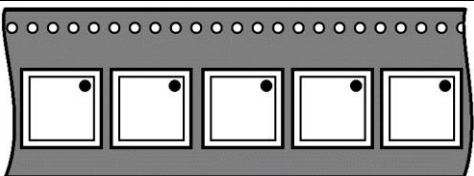
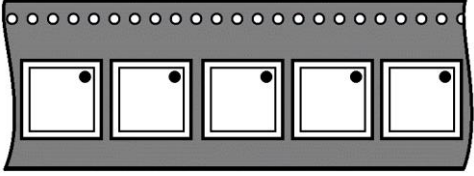
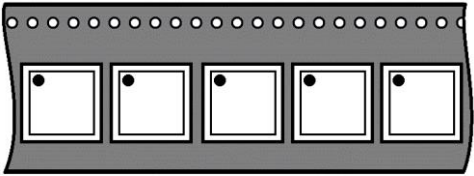
Package	Tape Width mm	Pitch mm	Component Orientation	Reel Diameter		Devices Per Reel or Min Order Quantity	TnR OPN Suffixes
				(mm)	(in)		
WDFN 2.0 x 2.0	8	4		178	7	3,000	TA
							TB
							T1
							T2
WDFN 2.0 x 2.0 4.0 x 3.0	12	8		330	13	3,000	TW
							TX
WDFN - 3, 6, 8, 10, 16 Lead 2.0 x 2.0 2.0 x 2.2 2.2 x 2.0 2.5 x 1.0 3.0 x 2.0 3.3 x 3.3 4.0 x 2.0	8	4		178	7	3,000	T1
							TA

BRD8011

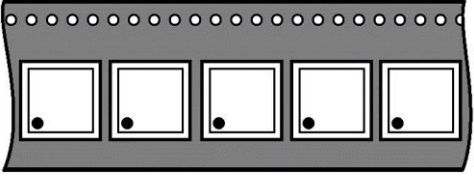
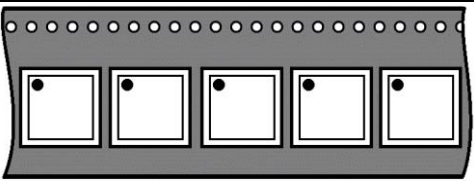
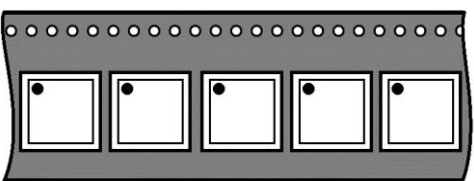
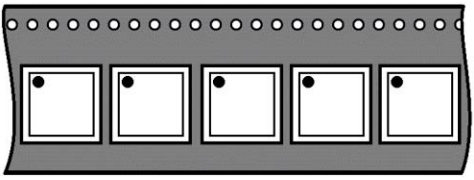
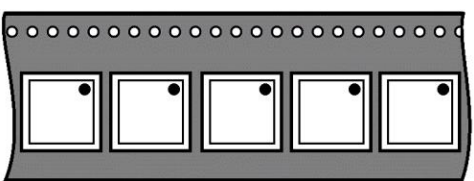
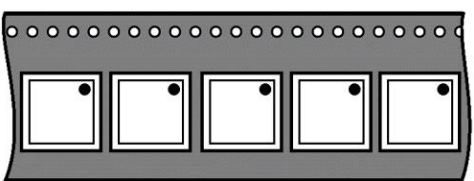
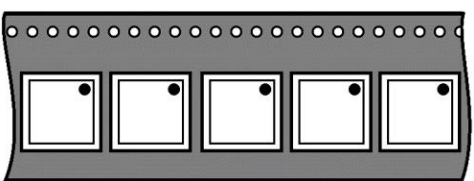
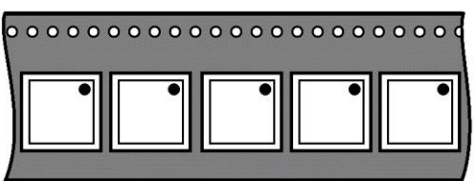
Package	Tape Width mm	Pitch mm	Component Orientation	Reel Diameter		Devices Per Reel or Min Order Quantity	TnR OPN Suffixes
				(mm)	(in)		
WDFN - 3, 6, 8, 10, 16 Lead 2.0 x 2.0 2.0 x 2.2 2.2 x 2.0 2.5 x 1.0 3.0 x 2.0 3.3 x 3.3 4.0 x 2.0	8	4		178	7	3,000	TC
	12	8		178	7	3,000	TA
	12	8		178	7	1,500	TA
				330	13	5,000	TW
WDFN / QFN 2.5 x 4.5	12	8		330	13	3,000	TW
		4				5,000	
		3,000					
		5,000					
WDFN 2 x 3	8	4		179	7	3,000	(NA)
	12	8				4,000	
WDFN 2.0 x 3.0	8	4		178	7	3,000	
WDFN 3.0 x 1.0	8	2				3,000	R2
WDFN 3.0 x 4.9	12	8		330	13	2,000	(NA)
						3,000	
WDFN 3.0 x 6.4	16	8				2,000	(NA)

BRD8011

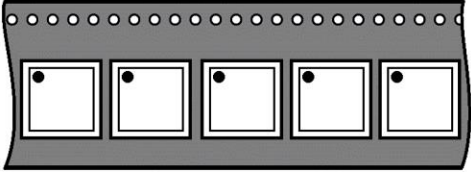
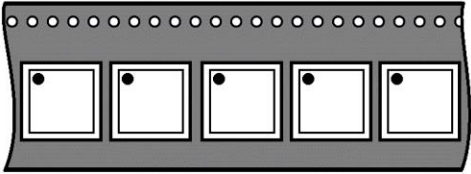
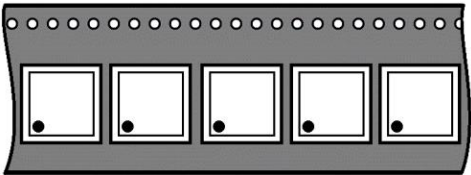
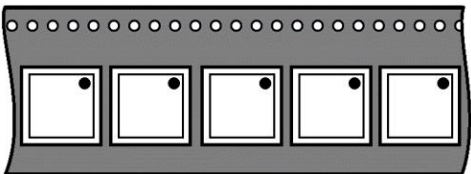
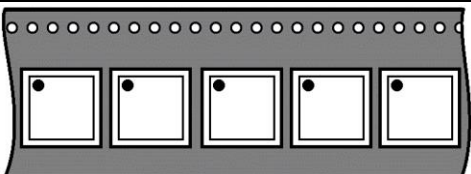
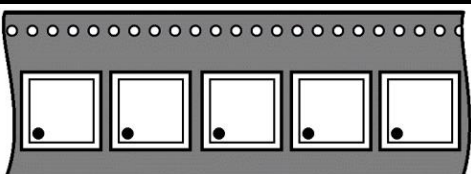
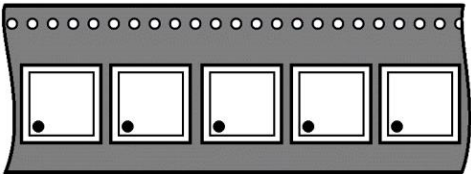
Package	Tape Width mm	Pitch mm	Component Orientation	Reel Diameter		Devices Per Reel or Min Order Quantity	TnR OPN Suffixes
				(mm)	(in)		
WDFN / QFN 3.5 x 9.0	24	8		330	13	5,000	TW
WDFN / QFN 4.05 x 4.5	12	8		330	13	3,000	TW
WDFN 6 x 4.9	12	8		330	13	2,000	NA
WQFNW 3.5 x 3.5	12	8		330	13	3,000	TX
WDFNW6 2.05 x 2.05 2.2 x 2.3	8	4		178	7	3,000	TA
WLCSP (EFCP) 1.0 x 1.0	8	4		178	7	5,000	T2
WLCSP (EFCP) 1.01 x 1.01	8	2				8,000	TC
WLCSP (EFCP) 1.26 x 1.26 1.46 x 1.46 1.61 x 1.61 1.81 x 1.81 1.91 x 1.46 2.7 x 1.81	8	4		178	7	5,000	TC

BRD8011

Package	Tape Width mm	Pitch mm	Component Orientation	Reel Diameter		Devices Per Reel or Min Order Quantity	TnR OPN Suffixes
				(mm)	(in)		
WLCSP (EFCP) 3.05 x 1.77	8	4		178	7	5,000	TD
WLCSP (EFCP) 3.54 x 1.77	12	4					
WLCSP 0.64 x 0.64 0.75 x 0.75	8	2		178	7	10,000	T2
		4				5,000	TA
WLCSP 1.4 x 0.8	8	2		178	7	10,000	T2
		4				178	
5,000							
WLCSP 1.11 x 0.98 1.38 x 1.03 1.620 x 1.635	8	4		178	7	5,000	TA
						3,000	
WLCSP 1.2 x 0.8 2.075 x 1.025 3.40 x 1.96	8	4		178	7	5,000	T2
WLCSP 0.99 x 0.65 1.145 x 0.75	8	2		178	7	10,000	T2
WLCSP 1.295 x 4.74 x 0.33 1.60 x 4.15 x 0.33	12	4		178	7	4,000	TB
WLCSP 0.77 x 2.27 x 0.33 0.58 x 2.19	8	4		178	7	4,000	TB

BRD8011

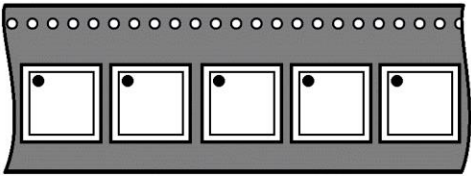
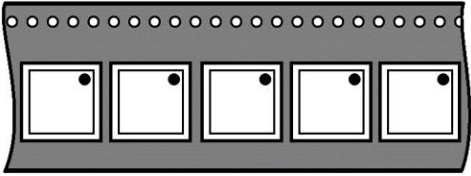
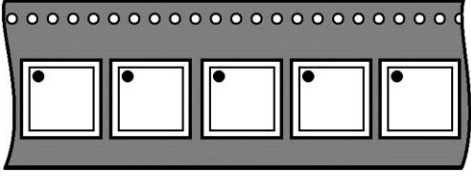
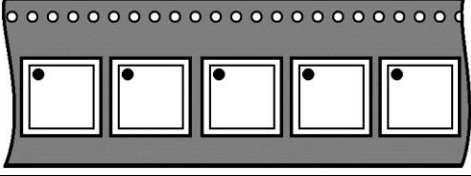
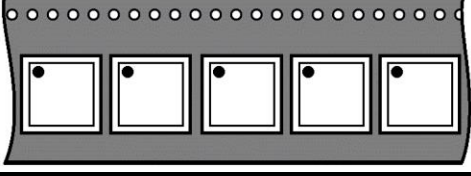
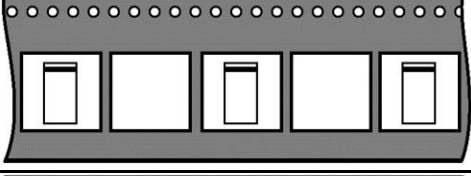
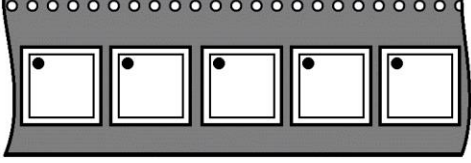
Package	Tape Width mm	Pitch mm	Component Orientation	Reel Diameter		Devices Per Reel or Min Order Quantity	TnR OPN Suffixes
				(mm)	(in)		
WLCSP * (0.6 to 3.4) x (0.6 to 3.9)	8	4		178	7	2,500	TA
						3,000	
						4,000	
WLCSP 4.95 x 6.57	16	8		178	7	1,000	TB
WLCSP 4 0.71 x 0.73	8	4		178	7	5,000	TA
X2QFN 1.5 x 1.5	8	4		178	7	5,000	TA
X2QFN 2.85 x 4.5 3.1 x 4.3	12	8		330	13	3,000	TW
X4DFN 0.445 x 0.24 0.62 x 0.32 0.60 x 0.30	8	2		178	7	10,000	T5
XDFN 1.0 x 1.0	8	4		178	7	3,000	TA

BRD8011

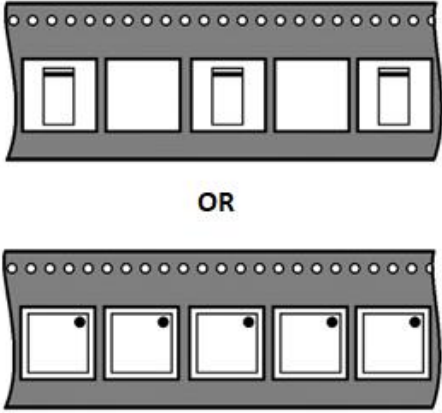
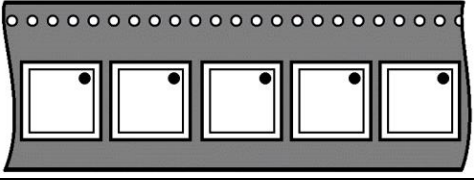
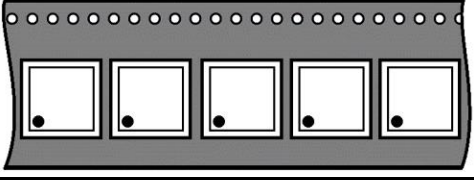
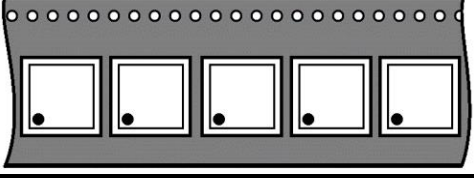
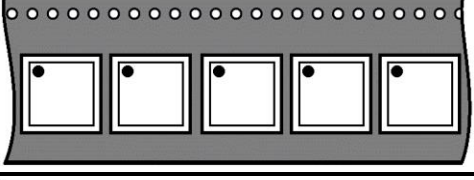
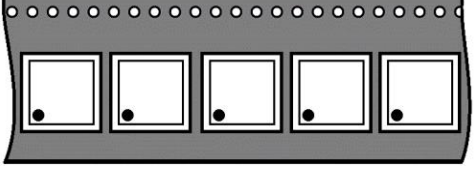
Package	Tape Width mm	Pitch mm	Component Orientation	Reel Diameter		Devices Per Reel or Min Order Quantity	TnR OPN Suffixes
				(mm)	(in)		
XDFN2 0.4 x 0.2mm to 3.0 x 1.6mm	8	2	 <p style="text-align: center;">OR</p>	178	7	8,000	T5
XDFN4 1.0 x 1.0mm	8	4		178	7	3,000 5,000	TB
							TC
XDFN4 1.2 x 1.2mm	8	4		178	7	3,000 5,000	TC
XDFN6 1.2 x 1.2mm	8	4		178	7	3,000 5,000	TA
							TC

BRD8011

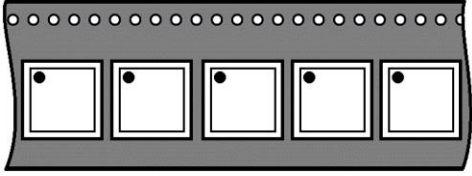
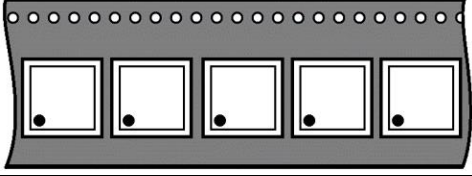
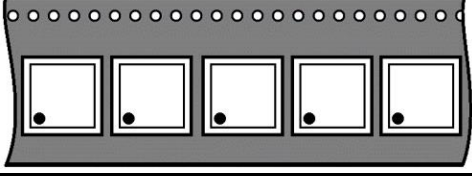
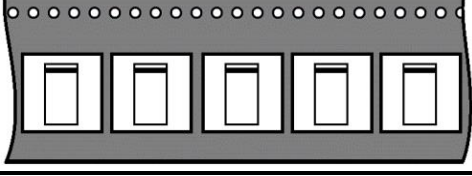
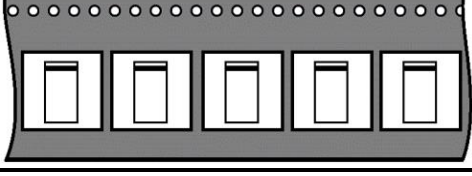
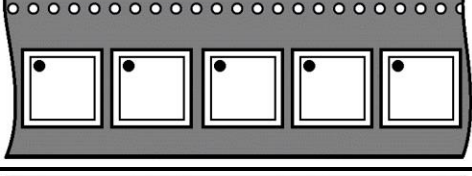
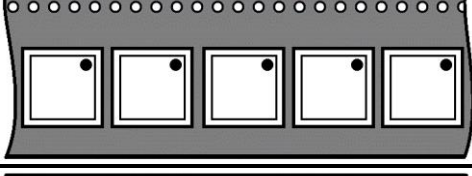
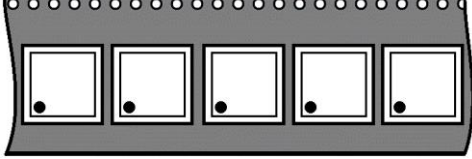
Package	Tape Width mm	Pitch mm	Component Orientation	Reel Diameter		Devices Per Reel or Min Order Quantity	TnR OPN Suffixes
				(mm)	(in)		
XDFN8 1.6 x 1.2	8	4		178	7	3,000 5,000	TA
XLLGA	8	2		178	7	8,000	T5
SIP 6 1.45 x 1.0	8	4		178	7	5,000	-
X3DFN 1.0 x 0.6	8	2		178	7	8,000	T5
X2DFNW-2 1.0 x 0.6 1.6 x 0.8	8	4		330	13	8,000	T5
XDFNW-6 1.0 x 1.0	8	4		178	7	3,000	TA
X2DFN-2 1.0 x 0.6	8	2		178	7	8,000	T5
X2DFN-3 1.0 x 0.6	8	2		178	7	8,000	T5

BRD8011

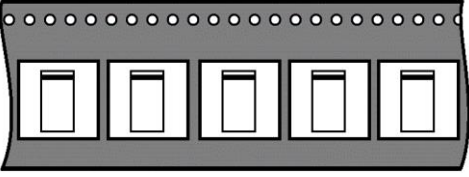
Package	Tape Width mm	Pitch mm	Component Orientation	Reel Diameter		Devices Per Reel or Min Order Quantity	TnR OPN Suffixes
				(mm)	(in)		
XDFNW-2 X2DFNW-2 1.0 x 0.6	8	2		178	7	8,000	T5

NOTE: If acquisitions' package information cannot be found from the table above, please refer to the next section of this document - *Embossed Tape and Reel Listing for Options and Ingrations.*

Embossed Tape and Reel Listing for Options and Integrations

- Flange opening on the front and the back of the reel are a supplier option but must meet all the requirements in Note 1. The preferred size for the 176 mm (7.0 in) reel is shown in Figure A.
- The tape loading opening must be as in Detail A.

9.4 GRAPHICS:

- The letters MPN and CPN are an option. The size and thickness of the letters are the manufacturer's option and are not to be used for inspection criteria.
- The embossed lines on the reel are an option. Embossed lines must be a minimum 38 mm (1.50 in) long. The thickness is a manufacturer's option and not to be used for inspection criteria.

9.5 Reel Labeling

Place the reel on an ESD protective surface so that the round sprocket holes are on the bottom. The direction of travel when unwound should be from the top right quadrant. See illustration below.

10.0 Seal Procedure

10.1 Taping equipment with vision.

10.1.1 Verify that the product lighting system is operating properly.

10.1.2 Verify that the correct program is available and that it is functioning properly.

10.2 Material and set-up verification

10.2.1 Verify that the product identification matches the accompanying documentation.

10.2.2 Verify that the proper embossed tape is mounted on the equipment.

10.2.3 Verify that the proper shipping reel is on the take up sprocket.

10.2.4 Verify that the proper process parameter settings are used for the specific equipment.

10.2.5 Verify that the equipment parameter settings are within the range defined in the appropriate table.

10.3 Sealing Parameters:

Sealing parameters are based on the material and machine qualification result. These parameters should be correct prior machine operation.

10.4 Leader and Trailer:

10.4.1 The TRAILER is the part of the tape that is near the hub of the plastic reel. TRAILER should have a minimum of 160mm in length and it consists of empty cavities with sealed cover tape.

10.4.2 The LEADER is the part of the tape that is at the outer part of the plastic reel. LEADER should have a minimum of 400mm in length and it consists of empty cavities with sealed cover tape.

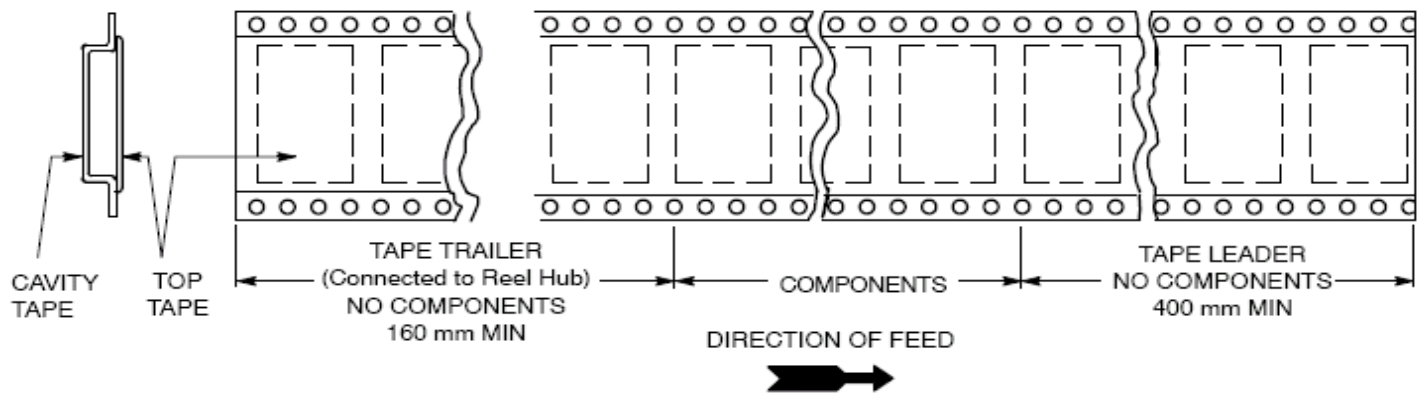
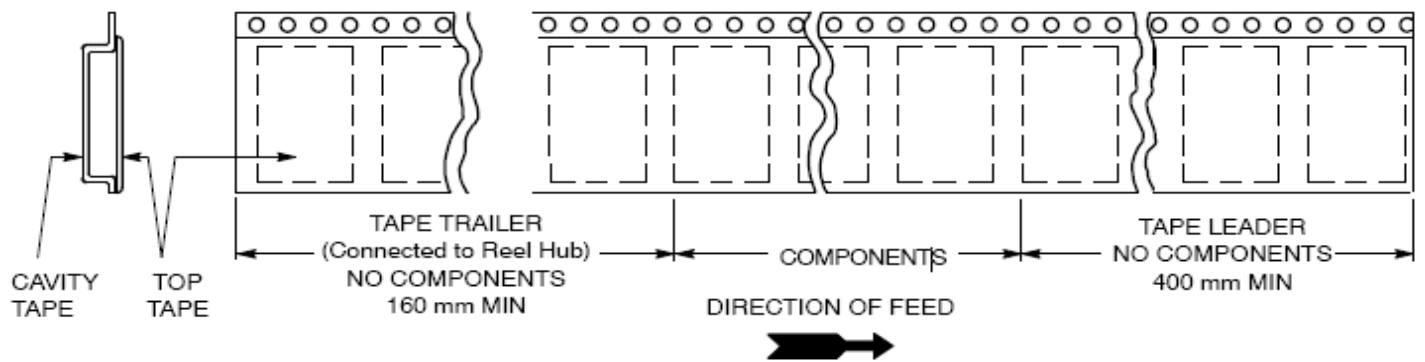

11.0 Embossed Carrier Tape Dimension and Specification

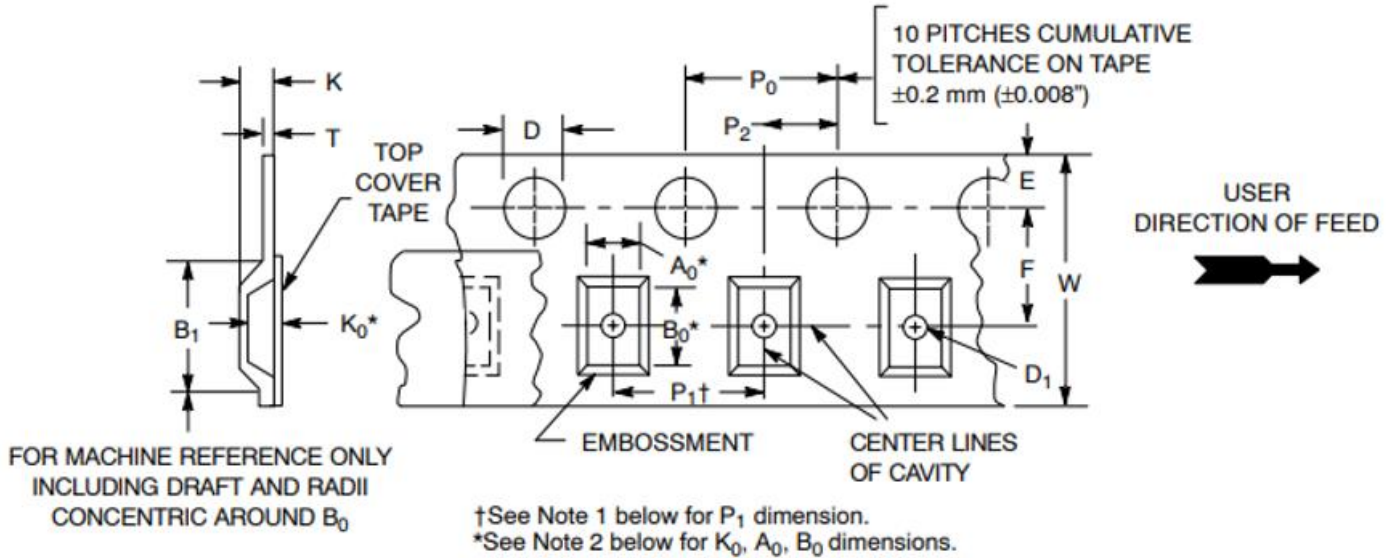

Maximum component rotation for punched and embossed carrier

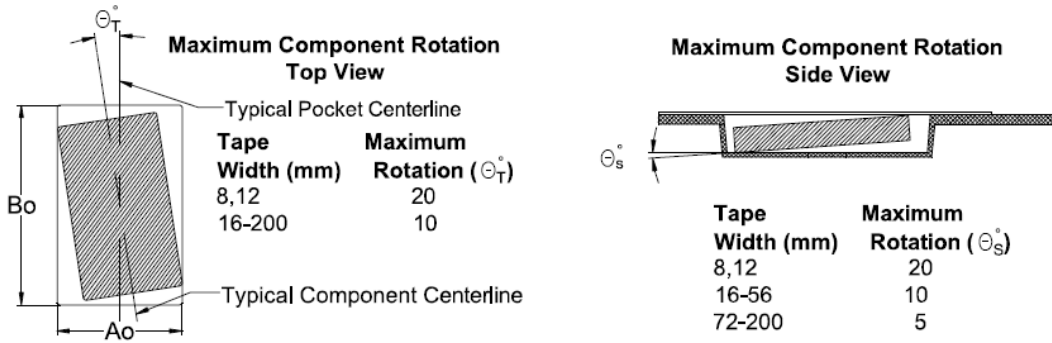

Maximum lateral movement for punched and embossed carrier

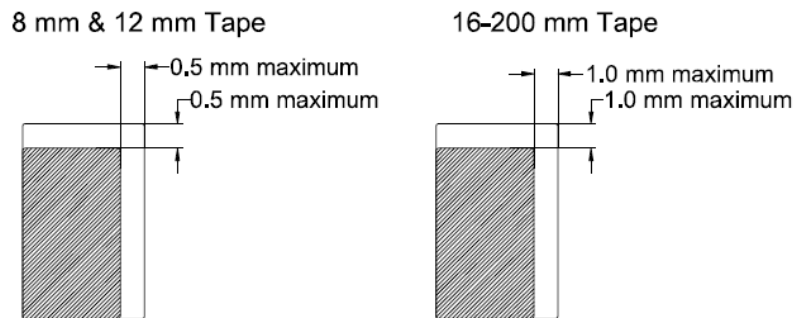

Bar code label area for punched and embossed carrier

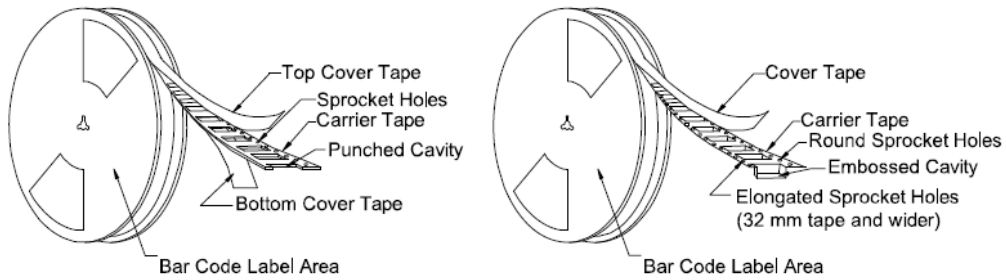

Bending radius for punched and embossed carrier

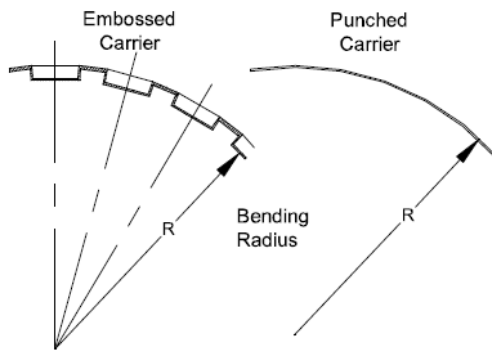

Maximum camber for punched and embossed carrier

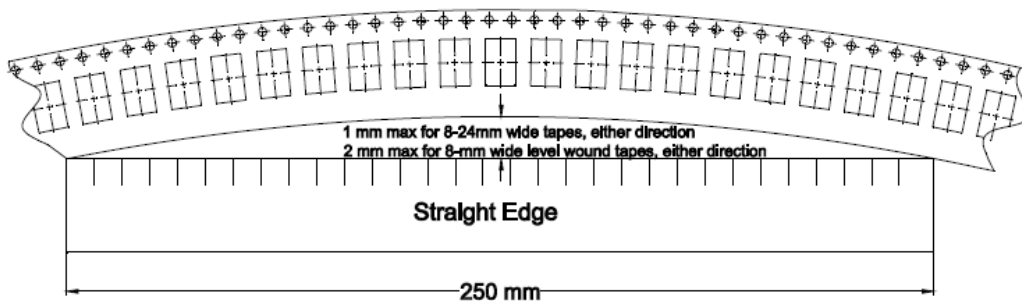

To accurately measure camber, place the starting end of the carrier tape sample on the left end of the measurement fixture or straight edge. Moving to the right, measure the allowable camber at the highest point between where the left edge and the right edge of the carrier tape make contact with the measurement fixture or straight edge.

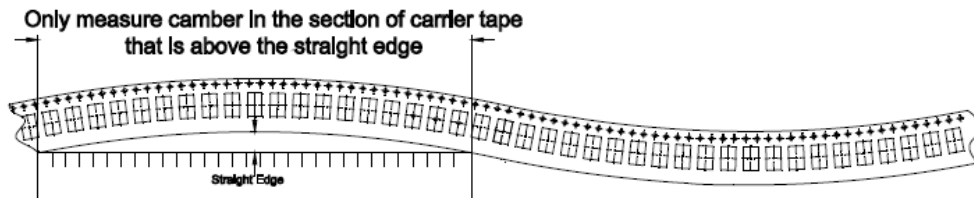

DIMENSIONS

Tape Size (W)	B ₁ Max (Note 1)	D	D ₁	E	F	K	P ₀	P ₂	R Min	T Max	W Max			
8 mm	4.55 mm (0.179")	1.5 + 0.1mm -0.0 (0.059 + 0.004" -0.0)	1.0 min (0.039") or 0.5mm Min (0.020")	1.75 ± 0.1 mm (0.069 ± 0.004")	3.5 ± 0.05mm (0.138 ± 0.002")	2.4 mm Max (0.094")	4.0 ± 0.1mm (0.157 ± 0.004")	1	25 mm (0.98")	0.6 mm (0.024") 0.3mm (0.012") for Powermite	8.3 mm (0.327")			
12 mm	8.2 mm (0.323")		1.5mm Min (0.060")		5.5 ± 0.05 mm (0.217 ± 0.002")	6.4 mm Max (0.252")						30 mm (1.18")	0.254mm (0.01") for sod123FL	12 ± 0.30mm (0.470 ± 0.012")
16 mm	12.1 mm (0.476")		7.5 ± 0.10 mm (0.295 ± 0.004")		7.9 mm Max (0.311")	16.3 mm (0.642")								
24mm	20.1 mm (0.791)		11.5 ± 0.1 mm (0.453 ± 0.004")		11.9 mm Max (0.468")	24.3 mm (0.957")								

1. Metric dimensions govern – English are in parentheses for reference only.
2. Pitch information (dimension P1) is contained in 7.0 Embossed Tape and Reel Listing
3. A0, B0, and K0 are determined by component size. The clearance between the components and the cavity must be within 0.05 mm min to 0.50 mm max. (See BRD8011 for exceptions) The component cannot rotate more than 10° within the determined cavity.

11.1 Seal Characteristics Evaluation

NOTE: Seal beads holding the cover tape to the carrier tape shall have the following characteristics:

- 11.1.1 The seal must be in from edge of cover tape. The rule of thumb is, if you can see a clear line of unsealed cover tape between seal and cover tape edge, it is good.

NOTE: In some situations, two or three power magnification should be used to determine compliance with the requirements of section 11.1.1

- 11.1.2 Seal should exhibit smooth, continuous pattern.

11.1.3 Discontinuities, up to 0.8 mm (1/32 inch) each and occurring at a ridge line, are permitted to a cumulative region length of 2M (80 inches). See [Broken] in Fig. 11.1.3 under 'Bad Seal.'

NOTE: This is the total tape length within the reel in which the described discontinuities can exist and still be acceptable.

GOOD SEAL	
Smooth, continuous	
BAD SEAL	
Broken	
Overlap	
Wavy	
Misaligned	
Stepped	

Figure 11.1.3 Sealing Line Patterns

11.2 Peel Evaluation Procedure

11.2.1 Perform test using the following parameters.

11.2.2 Record test reading on the appropriate documents.

NOTE: Test requirements are based on a 24-hr. maximum aging prior to the test.

Parameter	Range
Test strip length	60 mm min.
Pull angle	165-180 degrees
Pull speed	29-31cm/min (11.4-12.2
Length of pull	8 cm (3.1 inches) Minimum
Peak to peak pull force	10-130 grams
Peak to peak pull force	10-100 grams (8mm tape only)

Figure 11.2.2 Seal Evaluation – Pull Test Requirements

NOTE: During qualification procedures a test will be performed to verify that the Peel Force does not exceed 130 grams when sealed tape is test stored for 48 hours at 60 degrees centigrade.

NOTE: This test exceeds maximum storage temperature.

12.0 Verification of Reeled Products

12.1 Cover Tape

12.1.1 Damaged cover tape, including cuts, nicks, pinholes, or other imperfections that could lead to tape tearing, are not allowed.

12.1.2 The cover tape may not be spliced or reused.

12.1.3 There shall be no evidence of components in the carrier tape pockets adhering to the cover tape.

12.1.4 Adhesive materials, used to identify defective regions, are not allowed on the cover tape.

12.1.5 The following illustrations show correct and incorrect cover tape alignment.

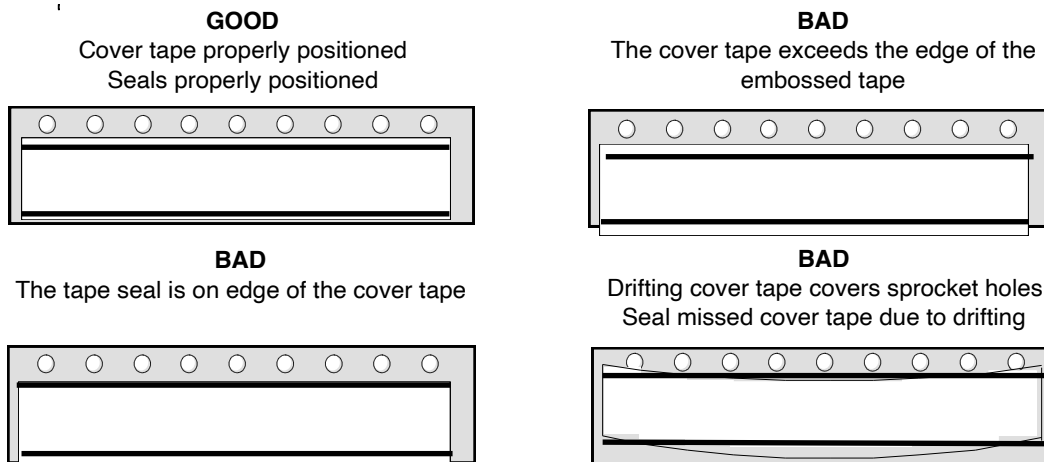

NOTE: Cover tape may exceed sprocket hole by $\frac{1}{4}$ of its diameter. More than $\frac{1}{4}$ of the sprocket hole diameter it will be considered misaligned cover tape and will be rejected.

NOTE: Cover tape should be inside the edge of the carrier tape, the rule of thumb is, if you can see a clear line of unsealed cover tape between seal and cover tape edge, it is good. In some situations, two or three power magnification should be used to determine compliance.

12.2 Carrier Tape

- 12.2.1 Damaged carrier tape, including cracking, through cuts, and punctures are not allowed.
- 12.2.2 The carrier tape may not be spliced or reused.
- 12.2.3 Taped product with verified Smashed or deformed carrier tape is not allowed except in the leader and trailer tapes.
- 12.2.4 The taping materials must not be exposed to temperatures above 40 degrees centigrade.

NOTE: EXPOSURE TO TEMPERATURE IS NOT RELATED TO SEALING OPERATION TEMPERATURE.

- 12.2.5 Adjacent rows of finished tape shall not adhere or stick to each other.

12.3 Product

- 12.3.1 Verify that no empty cavities exist between the first unit and the last unit in the reel of product.

Note: For non-reworkable devices such as the SOT723, maximum of 3 non-consecutive units or empty cavities are allowed between the first and last unit in the reel of the product.

Note: For package size 0.6 x 0.3 and smaller maximum of 5 units or empty cavities are allowed between the first and last unit in the reel of the product with no consecutive pockets with missing devices.

12.4 Reels

- 12.4.1 Verify that all reel tabs and locking devices are present.
- 12.4.2 Verify that the reel components that make up a complete reel have been securely locked together.
- 12.4.3 Check the clips / tabs to verify there are no stress marks. These marks reveal themselves in streaky white patterns.

13.0 Tape Retention on Reel

- 13.1 Completed reels of product will have a retaining band around the outermost tape layer on the reel.

Note: The retaining band must be the same width as that of the embossed tape.

- 13.2 Secured the retaining band with a piece of non-charging ESD adhesive tape. Adhesive from the tape must not contact the leader tape.

14.0 Embossed Tape and Reel Listing for Options and Integrations

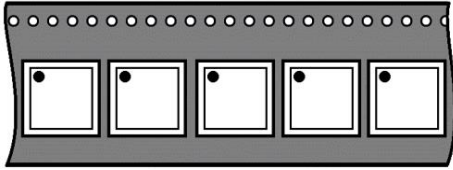
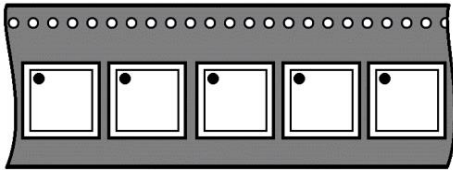
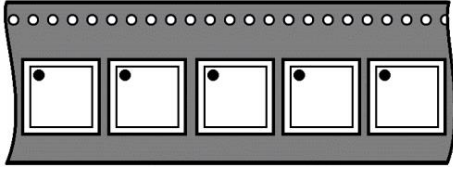
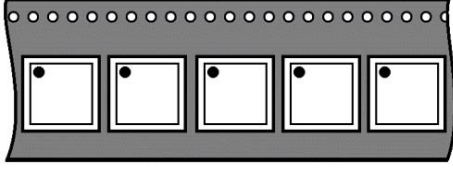
Package	Tape Width mm	Pitch mm	Component Orientation	Reel Diameter		Devices Per Reel or Min Order Quantity	TnR OPN Suffixes
				(mm)	(in)		
2020 - MicroLeadless™	8	4		178	7	3,000	(NA)
				330	13	10,000	
6 - Bump (1.489 x 0.989)	8	4		178	7	3,000	(NA)
9 - Bump (1.489 x 1.489)	8	4					
10 - Bump	8	4					
ARUSM-313 / REFLECTIVE RECTANGULAR SURFACE MOUNT	12	8	No Available Component Orientation (TBD)	178	7	1,000	For xFSC Legacy only
AXIAL LEAD	64	10	No Available Component Orientation (TBD)	330	13	1,250	For xFSC Legacy only
AXIAL LEAD DO 204	64	5	No Available Component Orientation (TBD)	330	13	4,000	For xFSC Legacy only
BGA 5 x 5	12	8		330	13	5,000	For xAMIS Legacy only
				178	7	100	For xAMIS Legacy only
BGA 6 x 6	12	8		330	13	1,000	For xAMIS Legacy only
BGA 7 x 7	16	12		330	13	1,500	For xAMIS Legacy only
BGA / LFBGA 8 x 8	16	12		330	13	1,500	For xAMIS Legacy only
BGA / LFBGA / CLCC 9 x 9				330	13	1,000	For xAMIS Legacy only

BRD8011

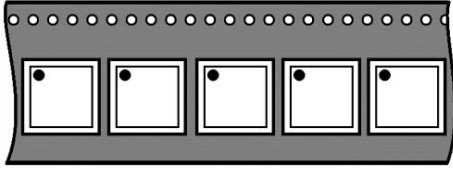
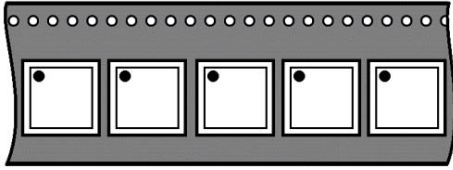
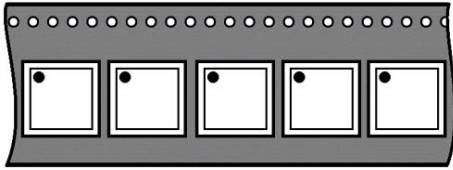
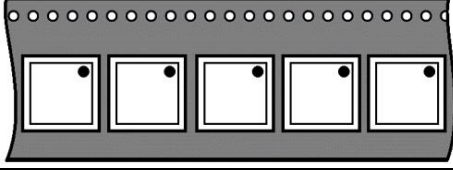
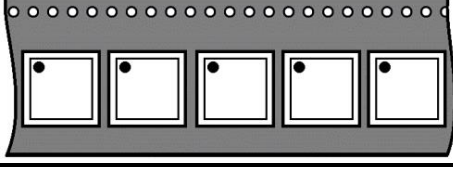
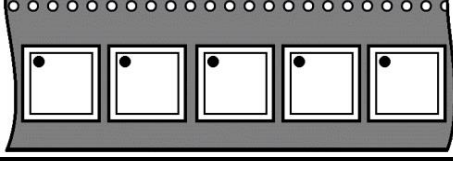
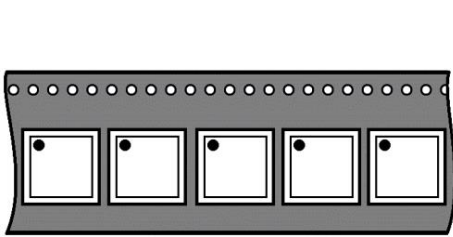
Package	Tape Width mm	Pitch mm	Component Orientation	Reel Diameter		Devices Per Reel or Min Order Quantity	TnR OPN Suffixes
				(mm)	(in)		
BGA / LFBGA 8 x 12	24	12		330	13	2,100	For xAMIS Legacy only
BGA / LFBGA 10 x 10	24	16		330	13	2,000	For xAMIS Legacy only
BGA 11 x 11	24	16		330	13	2,000	
BGA 12 x 12	24	16		330	13	2,000	For xAMIS Legacy only
BGA 13 x 13				330	13	2,000	
BGA 15 x 15	24	20		330	13	1,000	For xAMIS Legacy only
				330	13	1,200	
BGA 16 x 17	32	24		330	13	750	For xAMIS Legacy only
BGA 18 x 17	24	20		330	13	1,000	For xAMIS Legacy only
BGA 23 x 23	44	32		330	13	500	For xAMIS Legacy only
BGA 27 x 27	44	32		330	13	500	For xAMIS Legacy only

BRD8011

Package	Tape Width mm	Pitch mm	Component Orientation	Reel Diameter		Devices Per Reel or Min Order Quantity	TnR OPN Suffixes
				(mm)	(in)		
CLCC / LFBGA 9 x 9	16	12		330	13	1,000	For xAMIS Legacy only
CLCC 10 x 10	24	12		330	13	2,000	TW
CLCC 11.43 x 11.43	24	16				1,000	TW
CPH3	8	4		178	7	3,000	T1
CPH4	8	4		178	7	3,000	T1
CPH5				178	7	3,000	T1
CPH6	8	4		178	7	3,000	T1
				178	7	3,000	T2
CSP	12	8		330	13	500	(NA)
CUDFN 1.6 x 1.6 2 x 2	8	4		178	7	2,500	For xAMIS Legacy only

BRD8011

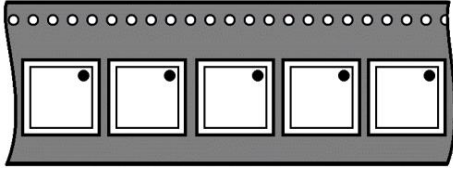
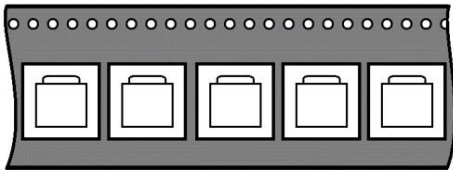
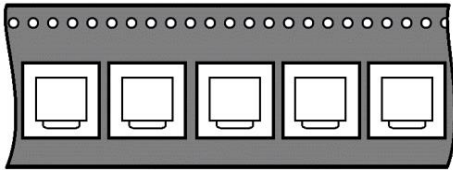
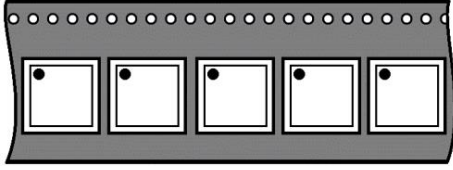
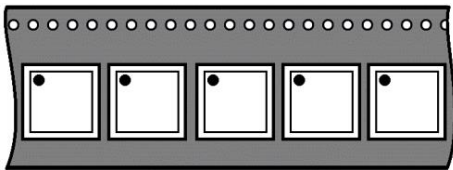
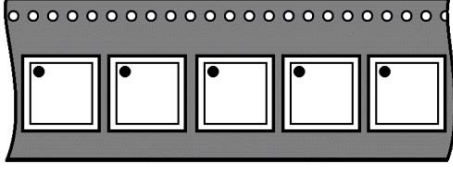
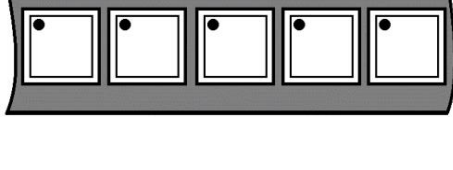
Package	Tape Width mm	Pitch mm	Component Orientation	Reel Diameter		Devices Per Reel or Min Order Quantity	TnR OPN Suffixes
				(mm)	(in)		
CWDFN 4 x 4	12	8		330	13	3,000	For xSensl Legacy Only
DPAK - 3 (TO-253 3 LD)	16	8	No Available Component Orientation (TBD)	330	13	5,000	For xFSC Legacy only
D2PAK 3 Lead	24	16		330	13	800	T4
D2PAK - 3 Lead (TO-263, 3 LEAD)	24	16	No Available Component Orientation (TBD)	330	13	1,600	For xFSC Legacy only
D2PAK - 6 Lead (TO-263, 6 LEAD)	24	16	No Available Component Orientation (TBD)	330	13	800	For xFSC Legacy only
D2PAK - 7 Lead (TO-263, 7 LEAD)	24	16		330	13	800	For xFSC Legacy only
DFN - 6 2 x 2	8	4		178	7	3,000	For xFSC Legacy only
DFN - 8 5.1 x 6.3 5 x 6	12	8		330	13	3,000	For xFSC Legacy only
DFN / WDFN 3 x 3	12	8		330	13	2,000	For xCatalyst Legacy Only
QFN / DFN / uQFN 3 x 3	12	8		330	13	3,000	For xAMIS Legacy only

BRD8011

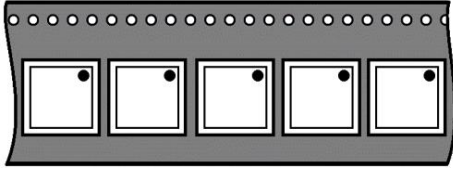
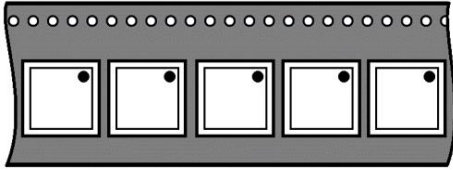
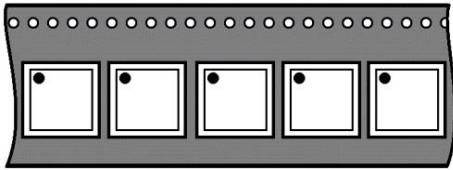
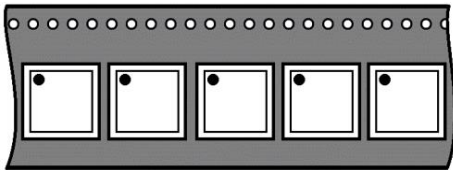
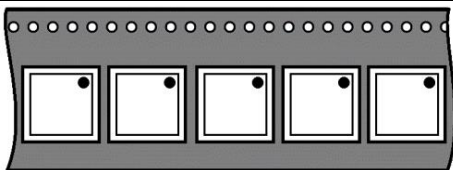
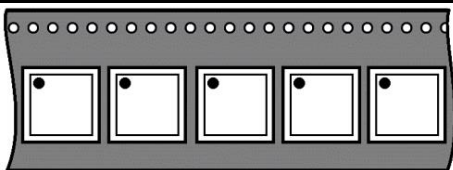
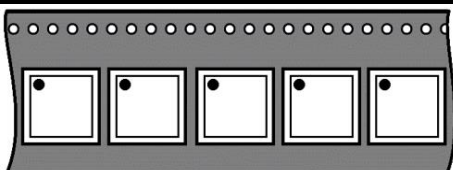
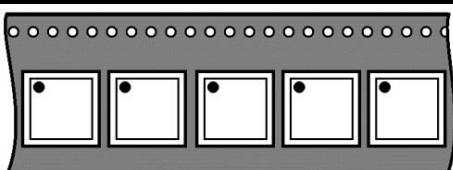
Package	Tape Width mm	Pitch mm	Component Orientation	Reel Diameter		Devices Per Reel or Min Order Quantity	TnR OPN Suffixes
				(mm)	(in)		
QFN / DFN / uQFN 3 x 3	12	8		330	13	2,500	For xAMIS Legacy only
						3,000	
QFN 3.5 x 9	24	8		330	13	5,000	For xAMIS Legacy only
QFN / DFN 4 x 4	12	8		330	13	2,500	For xAMIS Legacy only
				330	13	4,000	
DFN / QFN 2.0 x 2.0	8	4		178	7	3,000	(NA)
QFN / DFN / uDFN 2 x 2	8	4		178	7	3,000	For xAMIS Legacy only
QFN / uQFN 2.5 x 4.5	12	8		330	13	5,000	For xAMIS Legacy only
QFN / QFNW 7 x 7	16	12		330	13	2,500	For xAMIS Legacy only
QFN 4 x 5	12	8		330	13	4,000	For xAMIS Legacy only
QFN / QFNW 5 x 5	12	8		330	13	5,000	For xAMIS Legacy only
						3,000	
				178	7	1,000	

BRD8011

Package	Tape Width mm	Pitch mm	Component Orientation	Reel Diameter		Devices Per Reel or Min Order Quantity	TnR OPN Suffixes
				(mm)	(in)		
QFN 5 x 5	12	8		178	7	1,000	TB
						1,500	
QFN 5 x 7	16	8		330	13	4,000	For xAMIS Legacy only
QFN 6 x 5	16	8		330	13	5,000	For xAMIS Legacy only
DFN / QFN 6 x 6	12	8		330	13	3,000	TW
	16	12		330	13	3,000 2,500	For xAMIS Legacy only
QFN 8 x 8	16	12		330	13	500	For xAMIS Legacy only
						1,000	
						2,500	
QFN 9 x 9	16	12		330	13	2,500	For xAMIS Legacy only
QFN 10 x 10	24	16		330	13	2,000	For xAMIS Legacy only
DFN 8.9 x 5	18	8		330	13	2,500	For xAMIS Legacy only

BRD8011

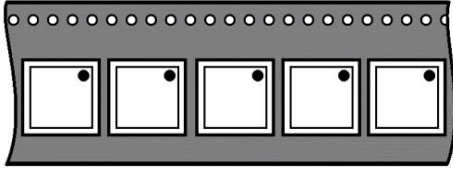
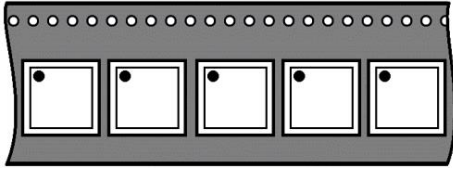
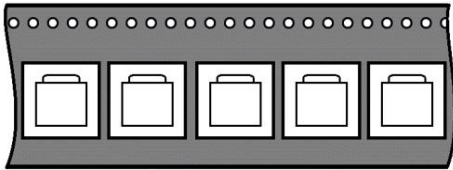
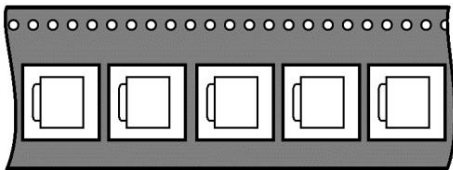
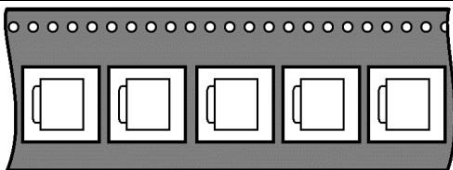
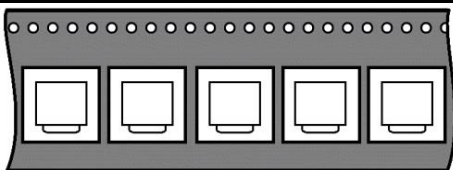
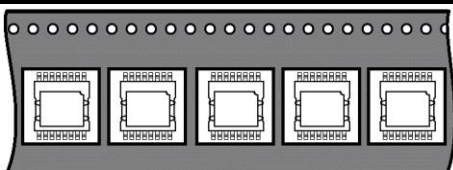
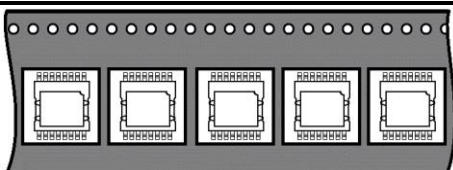
Package	Tape Width mm	Pitch mm	Component Orientation	Reel Diameter		Devices Per Reel or Min Order Quantity	TnR OPN Suffixes
				(mm)	(in)		
DFNW 8 x 8	16	12		330	13	3,000	TX
DFNW / WDFN 4.5 x 3	12	8		330	13	5,000	R2
				330	13	5,000	For xAMIS Legacy only
DPAK (TP-FA)	16	8		178	7	700	T4
DPAK (Single Gauge)	16	8		330	13	3,000	T4
DPAK	16	12		330	13	1,800	(NA)
	16	12		330	13	2,000	For xFSC Legacy only
	16	8		330	13	2,500	For xFSC Legacy only
DLFPAK / TCPAK 8.8 x 10.10 5.1 x 7.5	24	16		330	13	1,500	TX
	16	8		330	13	3,000	TX

BRD8011

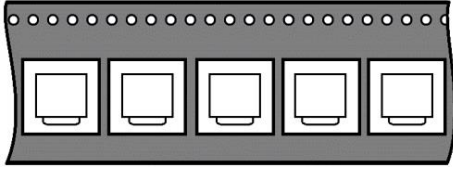
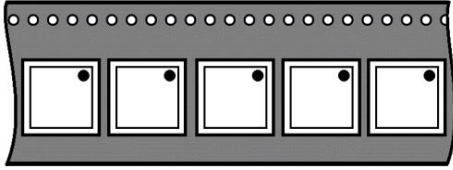
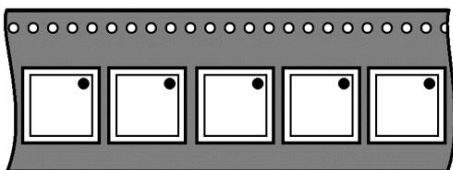
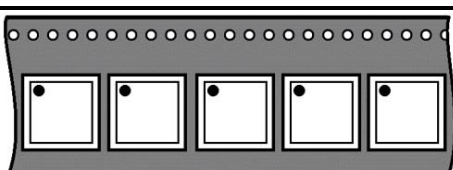
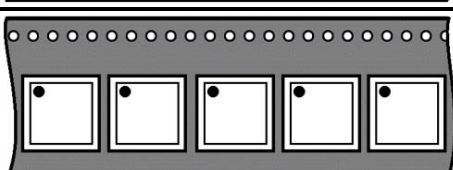
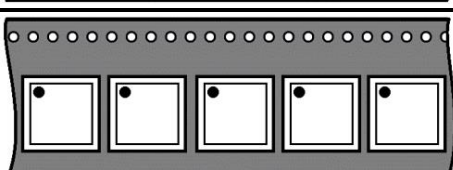
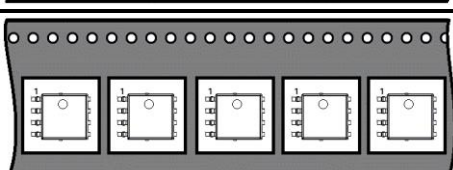
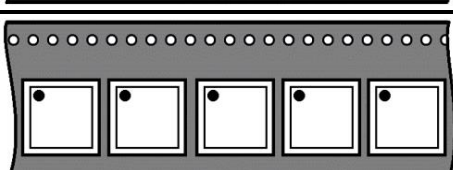
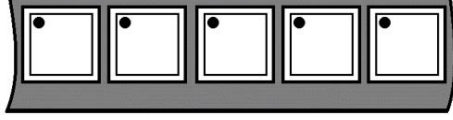
Package	Tape Width mm	Pitch mm	Component Orientation	Reel Diameter		Devices Per Reel or Min Order Quantity	TnR OPN Suffixes
				(mm)	(in)		
D2PAK - 3 Lead	24	16		330	13	800	For xFSC Legacy
GAQFN 6 x 6	16	12		330	13	3,000	For xAMIS Legacy only
H-PSOF8L 11.68 x 9.90 9.90 x 10.38	24	12		330	13	2,000	xFSC Legacy TX
HSOP-44	24	24		330	13	500	For xAMIS Legacy only
IBGA 7.5 x 7.5 9 x 9	16	12		330	13	2,000	TW
IBGA 11 x 8	24	16		330	13	1,400	-
LFPK 3.3 x 3.3 5 x 6	12	8		330	13	3,000	TW
LFBGA 5 x 5	12	8		330	13	5,000	(NA)
LFBGA 5 x 5	12	8		330	13	5,000	For xAMIS Legacy only

BRD8011

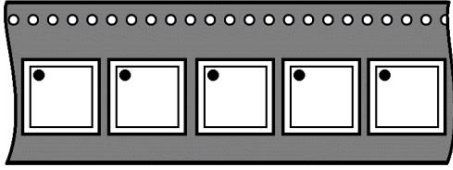
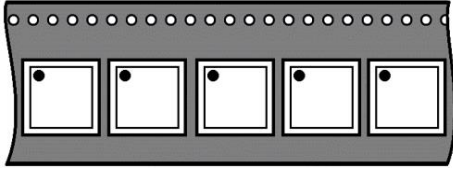
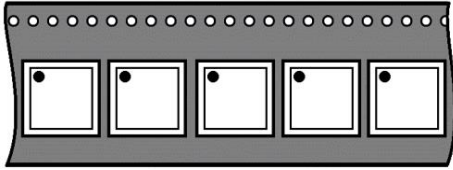
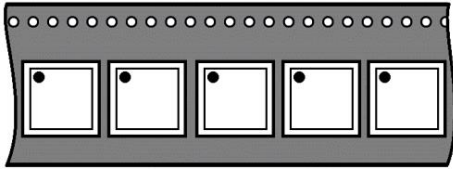
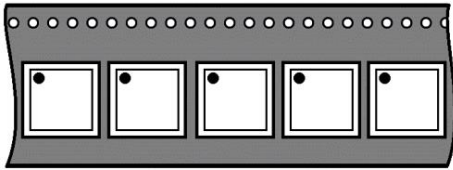
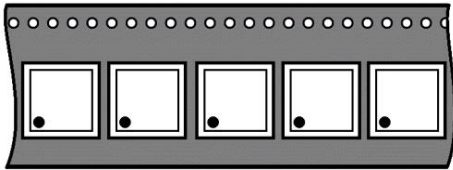
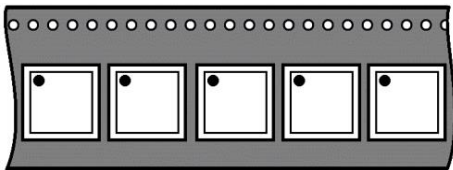
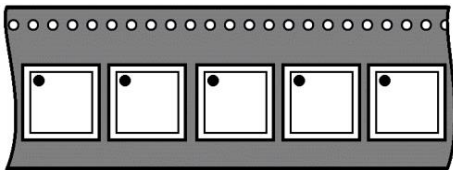
Package	Tape Width mm	Pitch mm	Component Orientation	Reel Diameter		Devices Per Reel or Min Order Quantity	TnR OPN Suffixes
				(mm)	(in)		
LFBGA 8 x 8 13 x 13	12	8		330	13	1,500	(NA)
						2,000	
LGA 16 3.3 x 3.3	12	8		330	13	3,000	For xFSC Legacy only
LGA 17 5.97 x 3.43	12	8		178	7	250	-
LQFP 32 7 x 7	16	16		330	13	2,000	For xFSC Legacy only
MSOP 8	12	8		330	13	2,500	For xPulscore Legacy only
MFP 4 4.1 x 4.4, 2.5P	16	8		178	7	3,000	For xSanyo Legacy only
MFP8/10S/10SJ/12S-HSSOP 8(225mil)	12	8		178	7	1,000	For xSanyo Legacy only
MFP14S.SSOP18/30 (225mil)	16	8		178	7	1,000	For xSanyo Legacy only

BRD8011

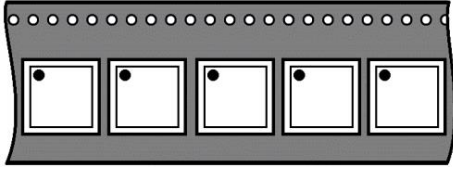
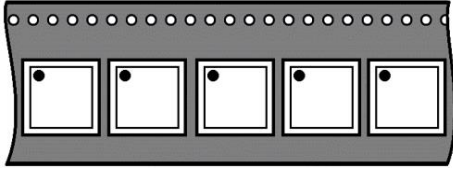
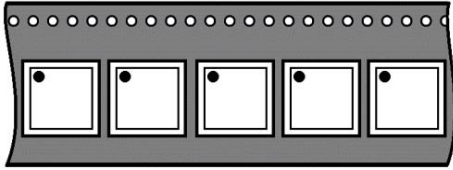
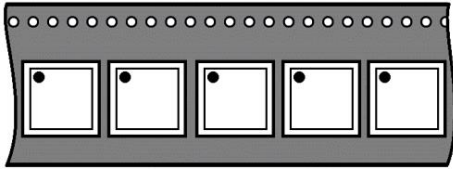
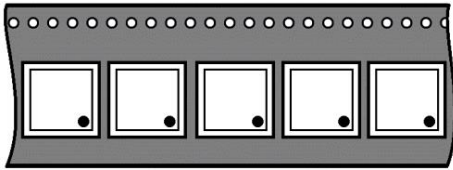
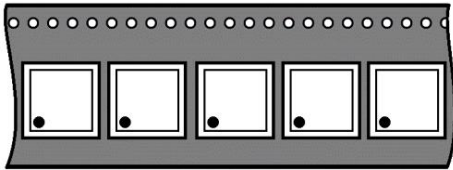
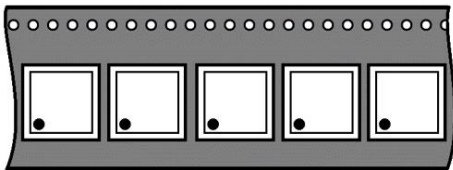
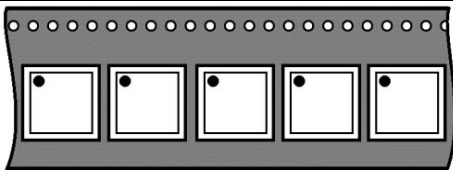
Package	Tape Width mm	Pitch mm	Component Orientation	Reel Diameter		Devices Per Reel or Min Order Quantity	TnR OPN Suffixes
				(mm)	(in)		
MFP14S-SS0P18(225mil)	16	8		178	7	3,000	For xSanyo Legacy only
MFP14/16 (225mil)	16	8		178	7	1,000	For xSanyo Legacy only
MFP16FS/18/20/24S (300 mil)	24	12		330	13	2,000	For xSanyo Legacy only
MFP24/30S/30SD/30SDJ/30S LF/36SD/36SDJ-HSOP24-HS OP28H/28HC (375 mil)	26	16		330	13	1,000	For xSanyo Legacy only
MFP28.HSOP36/36R.HSOP4 8/48R/48J.SSOP54/54R/54J (375mil)	24	16		330	13	1,000	For xSanyo Legacy only
MFP 4 2.5 x 4.4 3.85 x 4.4	12	8		330	13	2,500	For xFSC Legacy only
	12	8		330	13	3,000	
MFP 5 4.1 x 4.4	12	8		330	13	2,500	For xFSC Legacy only
Micro 8 lead Surface Mount	12	8		330	13	4,000	For xFSC Legacy only

BRD8011

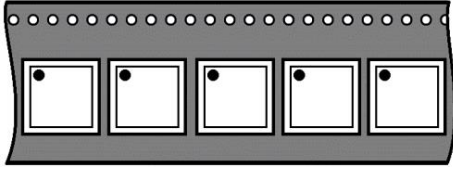
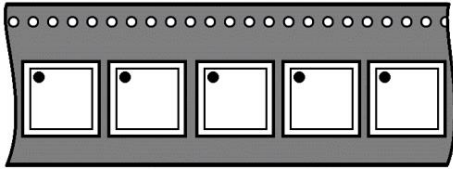
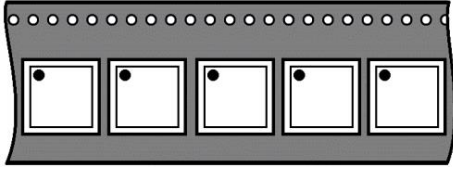
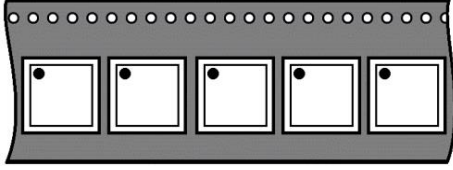
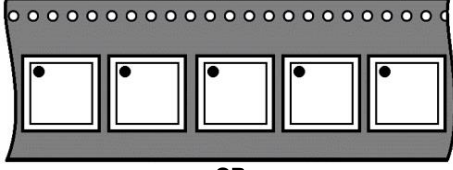
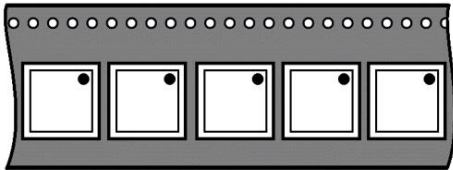
Package	Tape Width mm	Pitch mm	Component Orientation	Reel Diameter		Devices Per Reel or Min Order Quantity	TnR OPN Suffixes
				(mm)	(in)		
MSOP 10	12	8		330	13	4,000	For xFSC Legacy only
PDIP 4 GW	16	12	No Available Component Orientation (TBD)	330	13	1,000	For xFSC Legacy only
PDIP 6 7.3 x 6.5 8.51 x 6.35	16	12	No Available Component Orientation (TBD)	330	13	1,000	For xFSC Legacy only
PDIP 7 MINUS PIN 6 GW	16	12		330	13	1,000	For xFSC Legacy only
PDIP 8 GW	16	12		330	13	1,000	For xFSC Legacy only
						700	
PDIP 7.12 x 6.50	TBD	TBD		TBD	TBD	1,000	For xSanyo Legacy only
PLCC 2 LEAD	8	4		178	7	3,000	For xFSC Legacy only
			OR 				

BRD8011

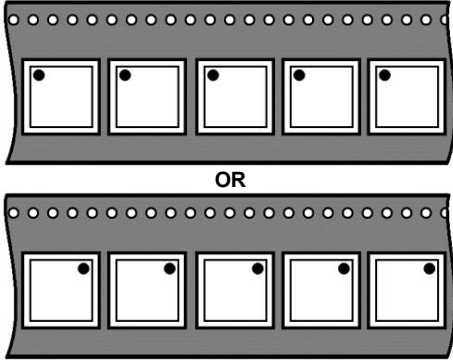
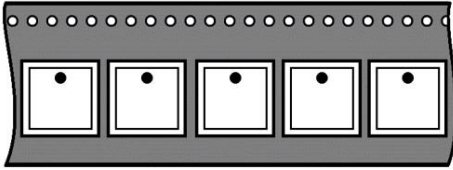
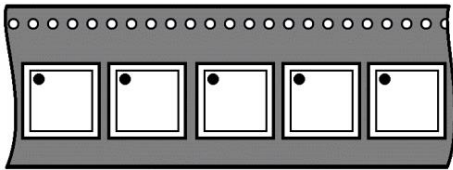
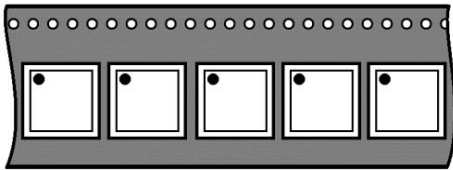
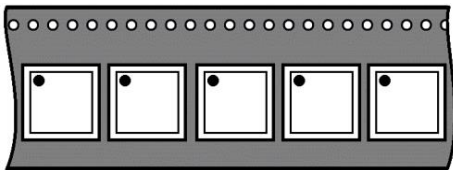
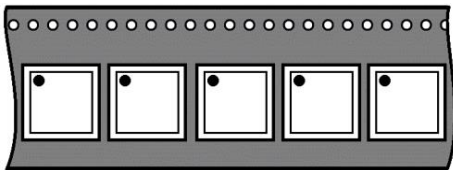
Package	Tape Width mm	Pitch mm	Component Orientation	Reel Diameter		Devices Per Reel or Min Order Quantity	TnR OPN Suffixes
				(mm)	(in)		
PLCC 2 LEAD	12	8	 <p style="text-align: center;">OR</p>	178	7	1,000	For xFSC Legacy only
PLCC-20	16	12		330	13	1,000	For xAMIS Legacy only
PLCC-28	24	16				750	
PLCC-44	32	24				500	
PLCC-52	32	20				450	
PLCC-68	44	32				250	
PLCC-84	44	36				250	
PQFN4 8 x 8	16	12		330	13	3,000	For xFSC Legacy only
PQFN6 2.05 x 2.05	8	4		178	7	3,000	For xFSC Legacy only
PQFN8 2.05 x 2.05	8	4		178	7	3,000	For xFSC Legacy only
PQFN8 3.3 x 3.3 3.3 x 5 5 x 6	12	8		330	13	3,000	For xFSC Legacy only

BRD8011

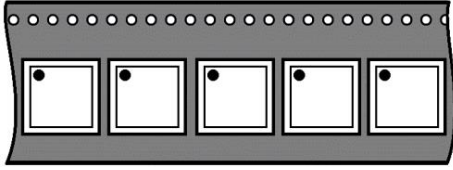
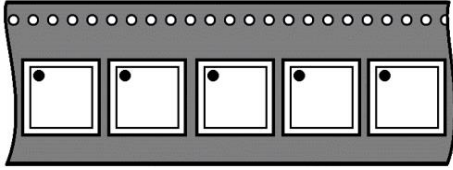
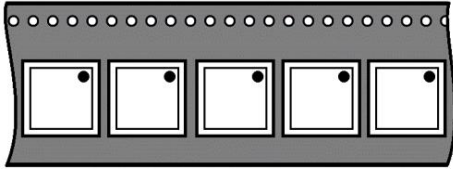
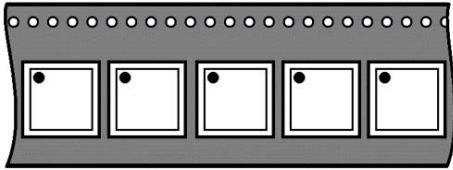
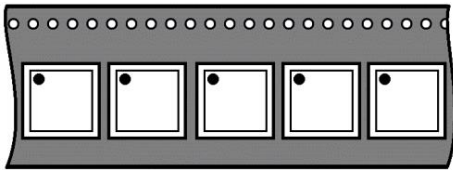
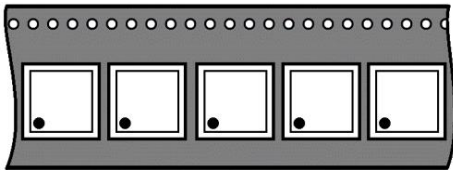
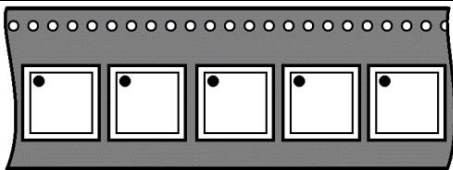
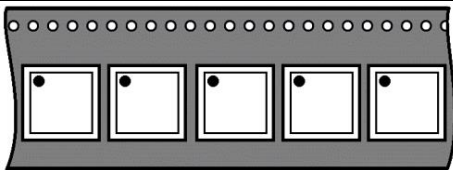
Package	Tape Width mm	Pitch mm	Component Orientation	Reel Diameter		Devices Per Reel or Min Order Quantity	TnR OPN Suffixes
				(mm)	(in)		
PQFN8 8 x 8	16	12		330	13	3,000	For xFSC Legacy only
PQFN12 3.3 x 5	12	8		330	13	3,000	For xFSC Legacy only
PQFN22 4.5 x 3.5	12	8		330	13	3,000	For xFSC Legacy only
PQFN25 4 x 5	12	8		330	13	3,000	For xFSC Legacy only
PQFN25 SPS45 SPS46	12	8		330	13	3,000	For xFSC Legacy only
PQFN27 12.9 x 12.9	24	16		330	13	3,000	For xFSC Legacy only
PQFN31 5 x 5	12	8		330	13	3,000	For xFSC Legacy only
PQFN34 5 x 5	12	8		330	13	3,000	For xFSC Legacy only

BRD8011

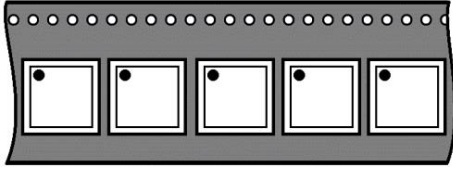
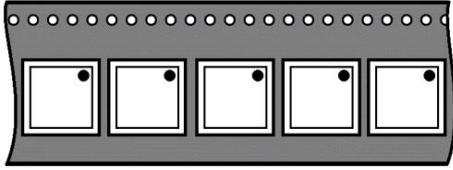
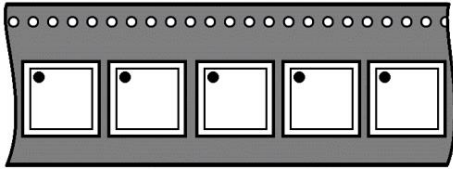
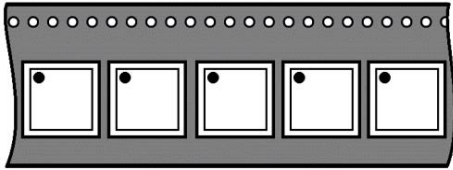
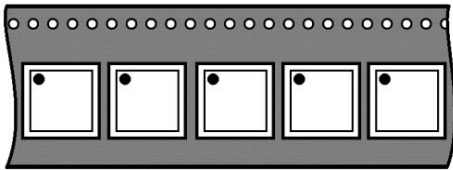
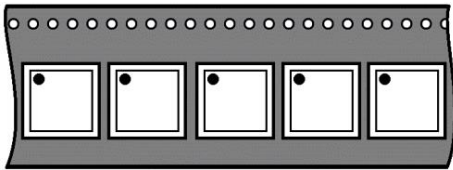
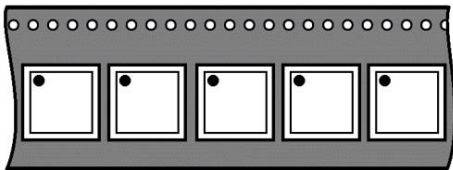
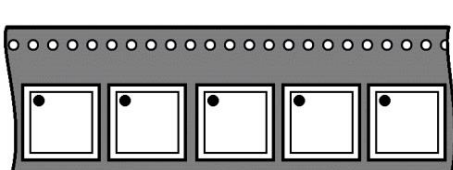
Package	Tape Width mm	Pitch mm	Component Orientation	Reel Diameter		Devices Per Reel or Min Order Quantity	TnR OPN Suffixes
				(mm)	(in)		
PQFN36 6 x 7.5	16	12		330	13	3,000	For xFSC Legacy only
PQFN39 5 x 6, 0.45P SPS3	12	8		330	13	3,000	For xFSC Legacy only
PQFN39 5 x 6, 0.45P SPS4	12	8		330	13	3,000	For xFSC Legacy only
PQFN40 6 x 6	12	8		330	13	3,000	For xFSC Legacy only
PQFN 3 x 3 3.3 x 3.3 3.3 x 5.0 5 x 6	12	8		330	13	3,000	For xFSC Legacy only
PQFN 8 x 8	16	12		330	13	3,000	For xFSC Legacy only
PQFP 10 x 10	24	24		330	13	750	For xAMIS Legacy only
PQFP 14 x 20	44	24		330	13	400	For xAMIS Legacy only
PQFP 28 x 28		40					

BRD8011

Package	Tape Width mm	Pitch mm	Component Orientation	Reel Diameter		Devices Per Reel or Min Order Quantity	TnR OPN Suffixes
				(mm)	(in)		
QFN 3.0 x 2.5	12	8		330	13	3,000	For xFSC Legacy only
QFN 1.2 x 1.6 x 0.9	8	4		330	13	8,000	For xSDT Legacy only
QFN 4 x 4	12	8				2,500	For xPulse Core Legacy only
QFN / DFN 6 x 6	16	12		330	13	2,500	TX
QFN 1.4 x 1.8	8	4		178	7	5,000	(NA)
QFN 14 3.0 x 2.5	12	8		330	13	3,000	For xFSC Legacy only
QFN 16 2.5 x 3.5	12	8		330	13	3,000	For xSanyo Legacy only
QSOP 16	12	8		330	13	2,500	For xFSC Legacy only
QSOP 24	16	8		330	13	2,500	For xFSC Legacy only

BRD8011

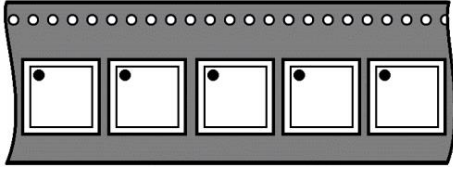
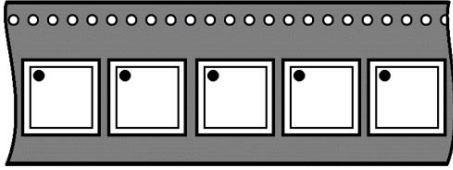
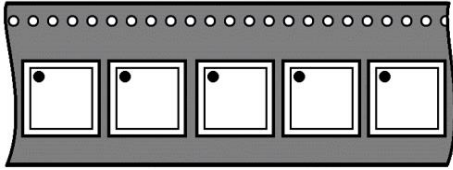
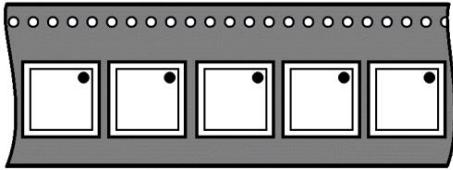
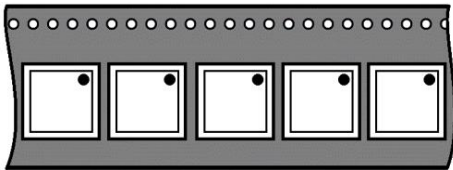
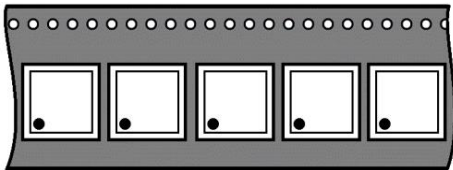
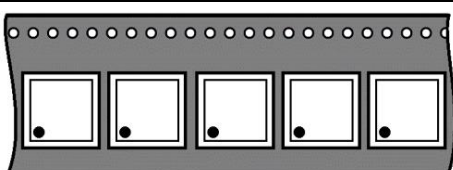
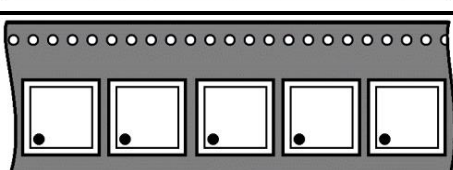
Package	Tape Width mm	Pitch mm	Component Orientation	Reel Diameter		Devices Per Reel or Min Order Quantity	TnR OPN Suffixes
				(mm)	(in)		
SSOP20J+HSSOP13 (225mil)	12	8		254	10	2,000	For xSanyo Legacy only
SSOP 16 (225mil)	12	8		254	10	2,000	For xSanyo Legacy only
SOIC 8 WB	16	12		330	13	2,000	For xCatalyst only
SPQFP 7 x 7	16	12		330	13	2,500	R2
SPM5 (MOD)	44	24		330	13	450	For xFSC Legacy only
SC-70, 3 LEAD 1.25 x 2	8	4		178	7	3,000	For xFSC Legacy only
SC-88 (SC-70 6 Lead) 1.25 x 2	8	4		178	7	3,000	For xFSC Legacy only
SC-88A (SC-70 5 Lead) 1.25 x 2	8	4		178	7	3,000	For xFSC Legacy only
				330	13		

BRD8011

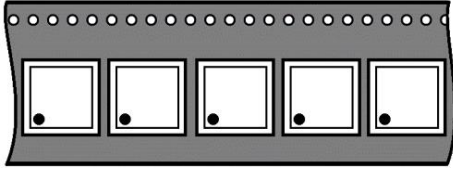
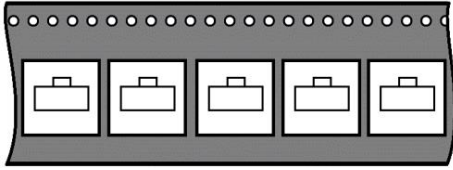
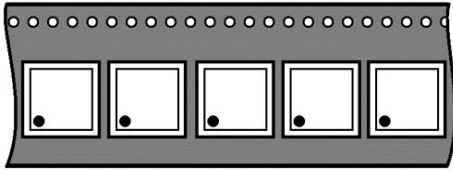
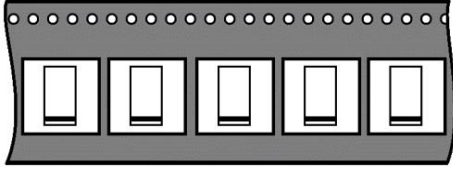
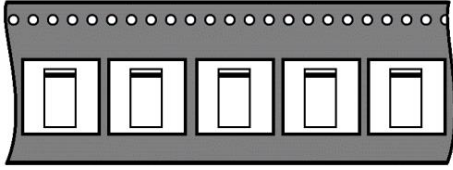
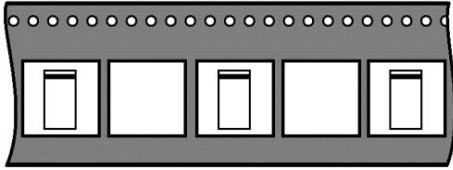
Package	Tape Width mm	Pitch mm	Component Orientation	Reel Diameter		Devices Per Reel or Min Order Quantity	TnR OPN Suffixes
				(mm)	(in)		
SC-88 / SC-70 6L / SOT-363 / SOT-23 6L	8	4		178	7	3,000	(NA)
				330	13	10,000	
SOT-23 3L	8	4		178	7	3,000	(NA)
SC-88A / SC-88AFL / SOT-353 / SC-70 5L	8	4		178	7	3,000	(NA)
				330	13	10,000	
SOD-123 2L SOD-123EP SOD-123FL SOD-323EP SOD-323FL	8	4	TOP LEFT TOP RIGHT	178	7	3,000	For xFSC Legacy only
SOD-523 2L SOD-923	8	4	TOP LEFT TOP RIGHT	178	7	8,000	For xFSC Legacy only
SOD-123 / SOD-323	8	4		178	7	3,000	(NA)
				330	13	10,000	
SOD-523	8	2		178	7	3,000	(NA)
		4		178	7	8,000	
SMA	12	8	No Available Component Orientation (TBD)	330	13	7,500	For xFSC Legacy only

BRD8011

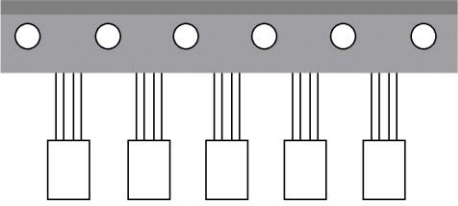
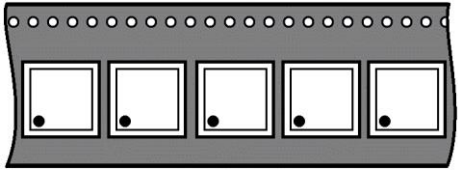
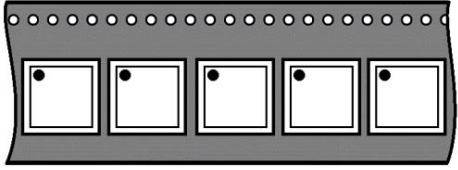
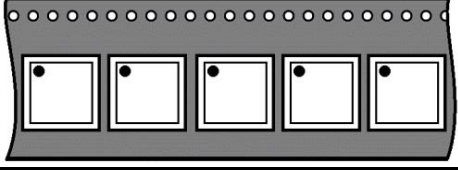
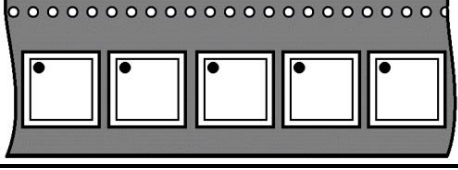
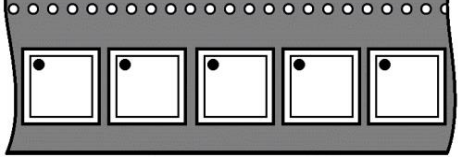
Package	Tape Width mm	Pitch mm	Component Orientation	Reel Diameter		Devices Per Reel or Min Order Quantity	TnR OPN Suffixes
				(mm)	(in)		
SMB	12	8	No Available Component Orientation (TBD)	330	13	3,000	For xFSC Legacy only
SMC	12	8	No Available Component Orientation (TBD)	330	13	3,000	For xFSC Legacy only
SIDELOOKER 4.44 x 5.08 x 2.54	18	12.7	 <small>*** Other package types/lead counts with same methodology may utilize this regardless of the lead count</small>	360	14.17	2,000	For xFSC Legacy only
SIP6 1.45 x 1.0	8	4		178	7	5,000	For xFSC Legacy only
SIP16 3.12 x 4.57	12	8		178	7	250	-
SIP19 5.25 x 2.90	12	8		178	7	250	-
SIP21 3.10 x 5.08	12	8		178	7	250	-
SIP25 5.59 x 3.18	12	8		178	7	250	-

BRD8011

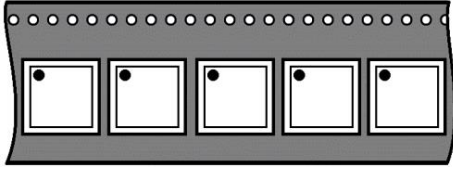
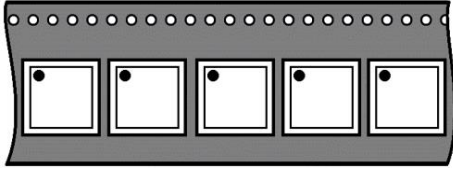
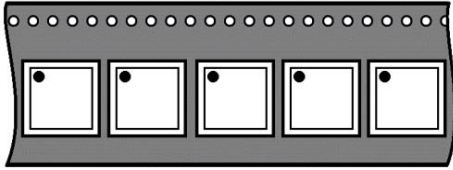
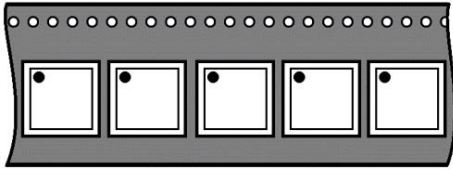
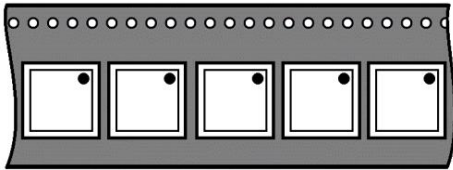
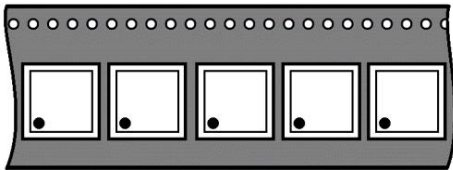
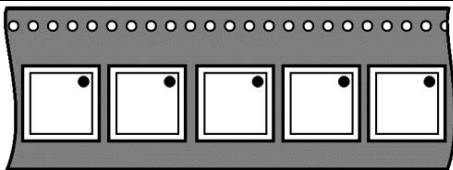
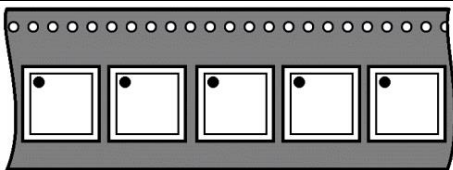
Package	Tape Width mm	Pitch mm	Component Orientation	Reel Diameter		Devices Per Reel or Min Order Quantity	TnR OPN Suffixes
				(mm)	(in)		
SIP25 5.72 x 3.18	12	8		178	7	250	-
SIP32 3.68 x 6.35	12	8		178	7	250	-
SIP33 3.1 x 4.75	12	8		178	7	250	-
SIP49 3.00 x 5.25	12	8		178	7	250	-
SIP50 4.064 x 3.81	12	8		330	13	1,000	-
SIP51 8 x 6	16	12		560	22	3,000	-
SIP52 3.94 x 3.76	12	8		330	13	1,000	-
SIP57 6.80 x 3.94	16	8		178	7	250	-

BRD8011

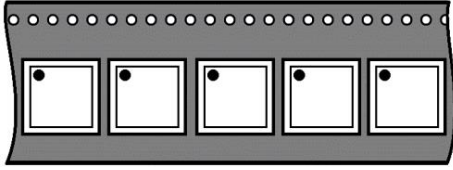
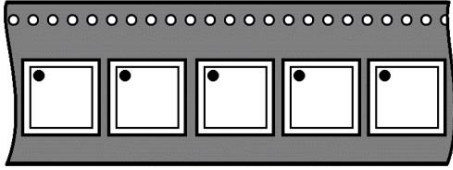
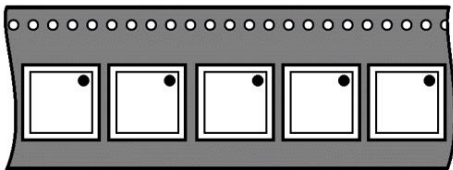
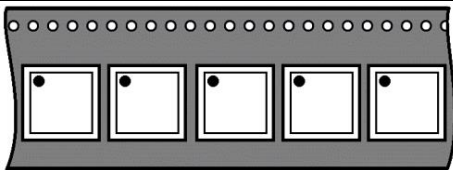
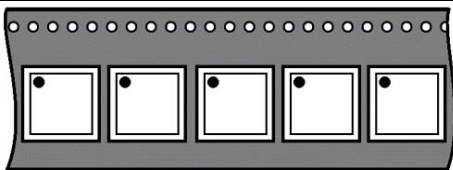
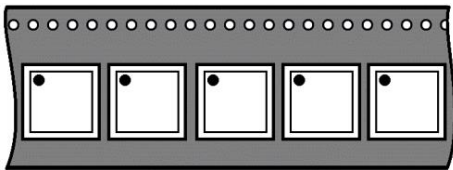
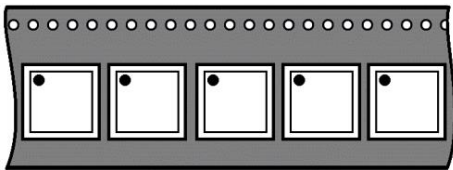
Package	Tape Width mm	Pitch mm	Component Orientation	Reel Diameter		Devices Per Reel or Min Order Quantity	TnR OPN Suffixes
				(mm)	(in)		
SIP58 5.85 x 4.75	12	8		178	7	1,000	-
SIP59 4.14 x 3.18	12	8		178	7	250	-
SOIC 4 W	12	8	No Available Component Orientation (TBD)	330	13	3,000	For xFSC Legacy only
SOIC 5 (SOIC6 W LESS PIN 2)	8	4		178	7	1,000	For xFSC Legacy only
SOIC 6 (SOP 6-Pin)	16	12		330	13	1,000	For xFSC Legacy only
SOIC 6 W	16	12		330	13	1,000	For xFSC Legacy only
SOIC 6 W LESS PIN 2	24	8	No Available Component Orientation (TBD)	330	13	1,000	For xFSC Legacy only
SOIC 7	12	8		330	13	2,500	For xFSC Legacy only
SOIC 8	12	8		330	13	2,500	For xFSC Legacy only

BRD8011

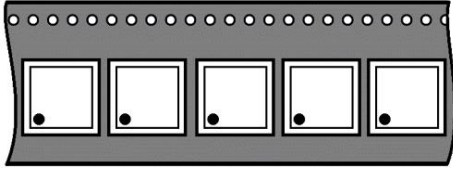
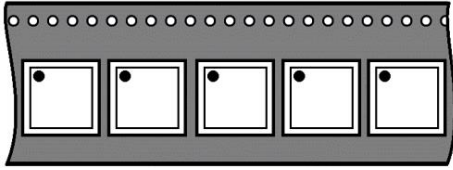
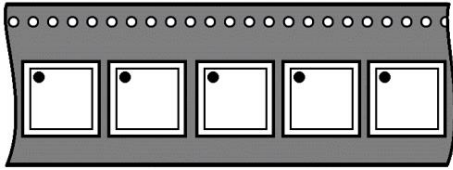
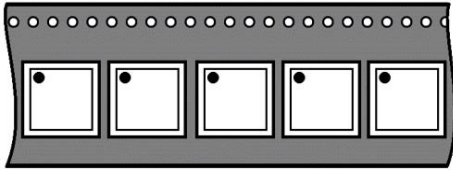
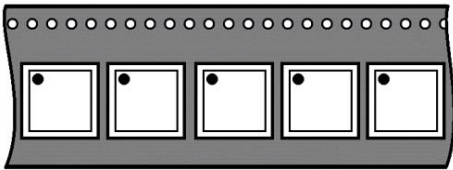
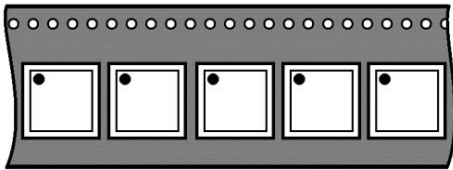
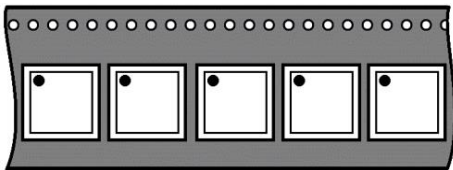
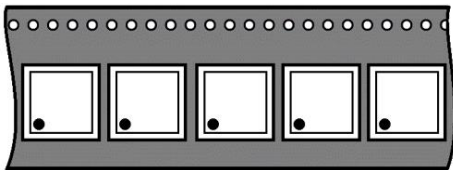
Package	Tape Width mm	Pitch mm	Component Orientation	Reel Diameter		Devices Per Reel or Min Order Quantity	TnR OPN Suffixes
				(mm)	(in)		
SOIC 8	12	8		330	13	2,500	For xFSC Legacy only
SOIC8 N MISSING PIN 7	12	8		330	13	2,500	For xFSC Legacy only
SOIC WB 8	16	12		330	13	1,000	(NA)
SOIC 8	12	8		330	13	1,000 2,000 2,500 3,000	For xSanyo Legacy only
SOIC NB 8 / SONB8	12	8		330	13	3,000	For xCatalyst and xAMIS Legacy Only
VSOIC 8	12	8		330	13	3,000	(NA)
SOIC 14	16	8		330	13	2,500	For xFSC Legacy only
SOIC 14 N	16	8		330	13	3,000	For xFSC Legacy only

BRD8011

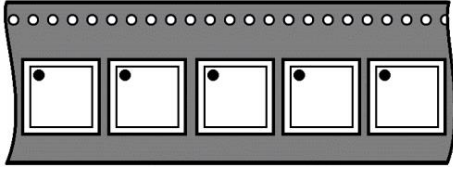
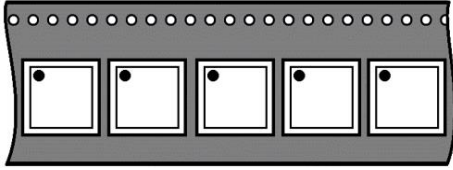
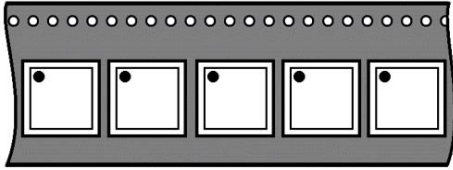
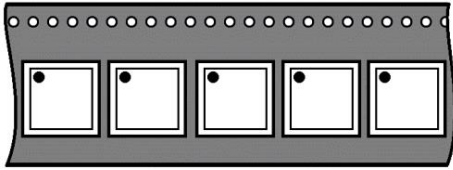
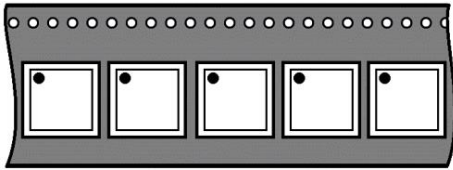
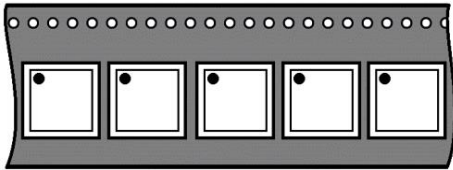
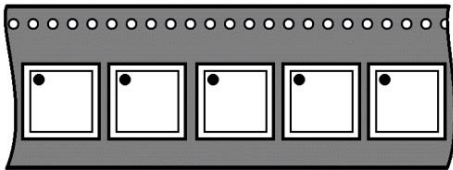
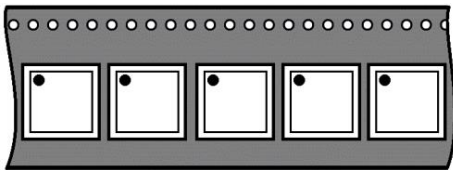
Package	Tape Width mm	Pitch mm	Component Orientation	Reel Diameter		Devices Per Reel or Min Order Quantity	TnR OPN Suffixes
				(mm)	(in)		
SOIC 16 N	16	8		330	13	3,000	For xFSC Legacy only
SOIC 16 150 MILS	16	8		330	13	2,500	For xFSC Legacy only
SOIC 16 W	24	16		330	13	750	For xFSC Legacy only
SOIC 16 300 MILS	16	12		330	13	1,000	For xFSC Legacy only
SOIC NB 14 / SONB 14	16	8		330	13	2,000	For xCatalyst and xAMIS Legacy Only
SOIC NB 16 / SONB 16	16	8		330	13	2,000	For xCatalyst and xAMIS Legacy Only
SOIC WB 16	16	12		330	13	1,500	For xAMIS Legacy only
SOIC WB 18	24	12		330	13	1,500	For xAMIS Legacy only

BRD8011

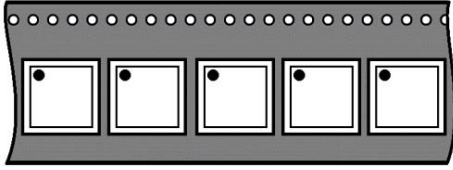
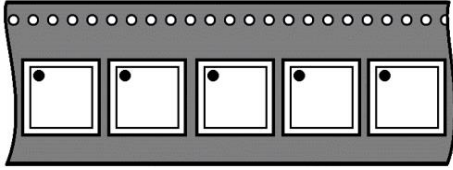
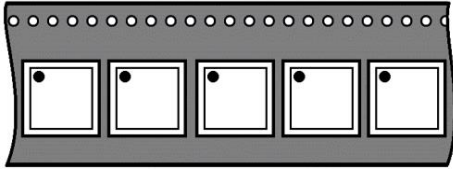
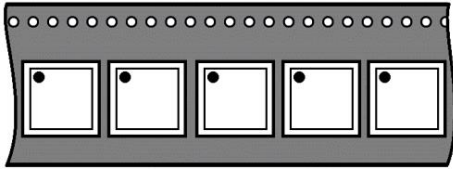
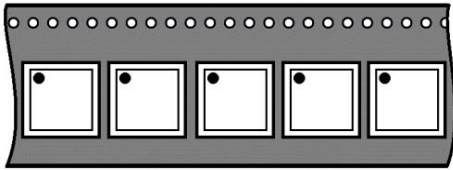
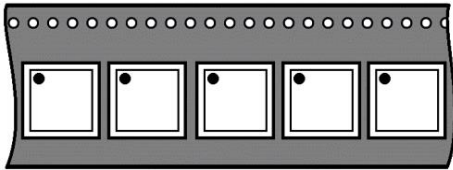
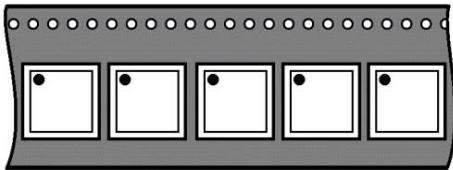
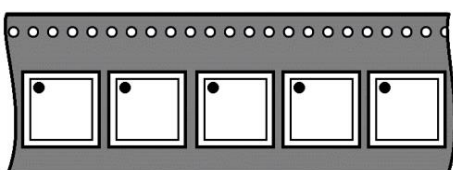
Package	Tape Width mm	Pitch mm	Component Orientation	Reel Diameter		Devices Per Reel or Min Order Quantity	TnR OPN Suffixes
				(mm)	(in)		
SOIC 20 300 mils	24	12		330	7	1,000	For xFSC Legacy only
SOIC 28 300 MILS	24	12		330	13	1,000	For xFSC Legacy only
SOIC WB 20 / SOWB 20	24	12		330	13	1,500	For xPulse Core Legacy Only
				330	13	1,500	For xAMIS Legacy only
SOIC WB 24 / SOWB 24	24	16		330	13	1,000	For xCatalyst Legacy Only
SOIC WB 24	24	12		330	13	1,500	For xAMIS Legacy only
SOIC WB 28 / SOWB 28	24	12		330	13	500	For xCatalyst Legacy Only
SOIC WB 28	24	12		330	13	1,500	For xAMIS Legacy only
SOIC WB 32	32	16		330	13	1,000	For xAMIS Legacy only

BRD8011

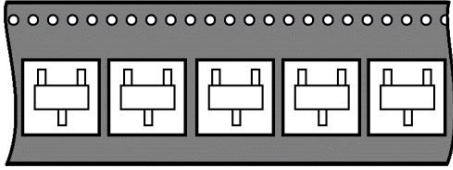
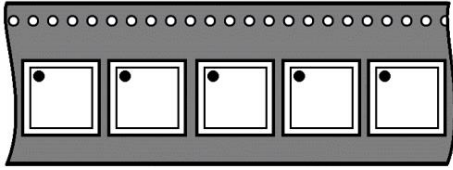
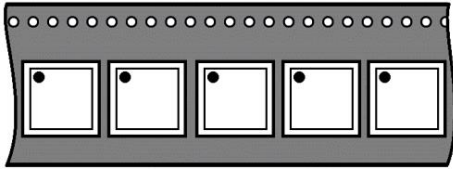
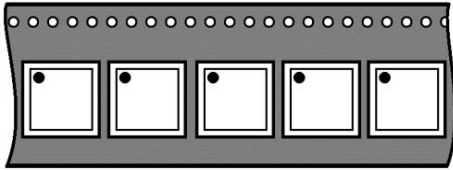
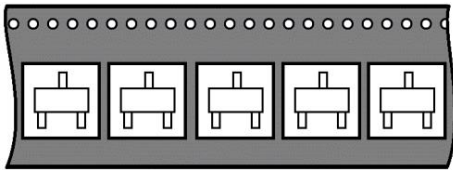
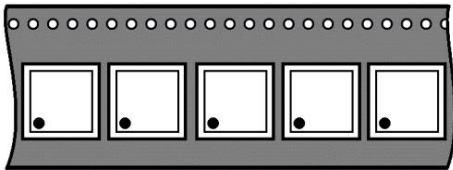
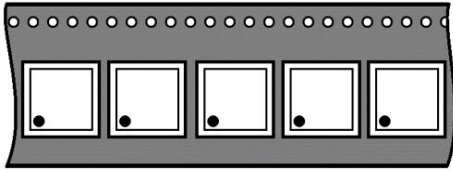
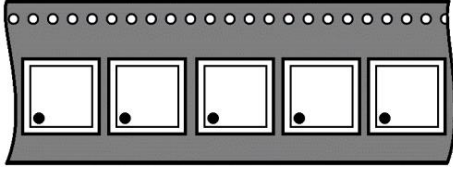
Package	Tape Width mm	Pitch mm	Component Orientation	Reel Diameter		Devices Per Reel or Min Order Quantity	TnR OPN Suffixes
				(mm)	(in)		
SOT - 23 SC - 59 SC - 70 SC - 75 SC - 89	8	4		178	7	3,000	(NA)
				330	13	10,000	(NA)
SOP 14	16	12		330	13	2,000	For xFSC Legacy only
SOP 16	16	12		330	13	2,000	For xFSC Legacy only
SOP 20	24	12		330	13	2,000	For xFSC Legacy only
SOT - 23	8	4		178	7	3,500	T7
SOT - 23 5 Lead	8	4		178	7	3,000	For xCatalyst Legacy Only
SOT - 23 6 Lead	8	4		178	7	3,000	For xCatalyst Legacy Only
SOT - 23 8 Lead	8	4		178	7	3,000	For xCatalyst Legacy Only

BRD8011

Package	Tape Width mm	Pitch mm	Component Orientation	Reel Diameter		Devices Per Reel or Min Order Quantity	TnR OPN Suffixes
				(mm)	(in)		
SOT - 89	12	8		330	13	3,000	For xPulse Core Legacy only
				178	7	1,000	(NA)
SOT - 143	8	4		178	7	3,000	(NA)
				330	13	10,000	
SOT - 223 4L	16	12		330	13	2,500	For xPulse Core Legacy Only
SOT - 553	8	2		178	7	16,000	T3
SOT - 563	8	4		178	7	5,000	T3
SOT - 953 5 Lead	8	2		178	7	8,000	T6
SOT - 963 6 Lead	8	2					

BRD8011

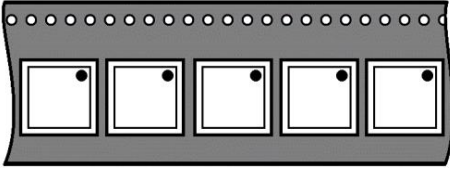
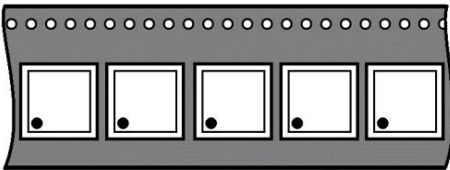
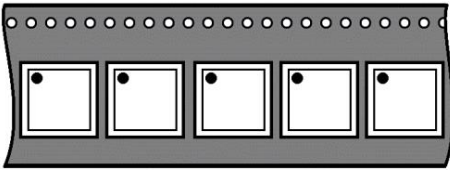
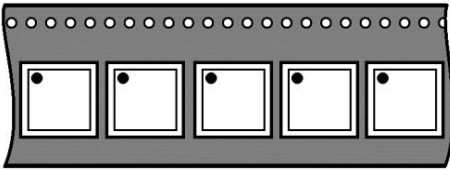
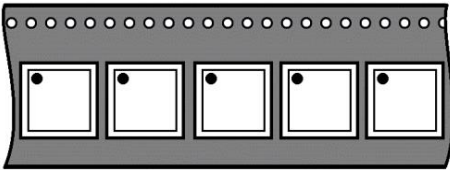
Package	Tape Width mm	Pitch mm	Component Orientation	Reel Diameter		Devices Per Reel or Min Order Quantity	TnR OPN Suffixes
				(mm)	(in)		
SPQFP / PQFP 14 x 14	100	24		330	13	650	For xAMIS Legacy only
SPM5D-023 / SPM5_SPM23-BA SMD TYPE	44	24	No Available Component Orientation (TBD)	330	13	450	For xFSC Legacy only
SPM5H-023 / 23LD, PDD STD, SPM23-BD (Ver1.5) SMD TYPE	44	24	No Available Component Orientation (TBD)	330	13	450	For xFSC Legacy only
SSOP4 / LSOP04	16	8		330	13	3,000	For xFSC Legacy only
SSOP 28	16	12		330	13	2,000	For xFSC Legacy only
SSOP 5.3mm 14/16/20/24/28	16	12		330	13	2,000	For xAMIS Legacy only
SSOP 36 EP	16	12		330	13	1,500	For xAMIS Legacy only
SSOP 36 EP	24	12		330	13	1,500	For xAMIS Legacy only
SSOP 24 NB	16	8		330	13	2,500	For xAMIS Legacy only
SSOP20/24-HSSOP14 (225mil)	12	8		254	10	2,000	For xSanyo Legacy only

BRD8011

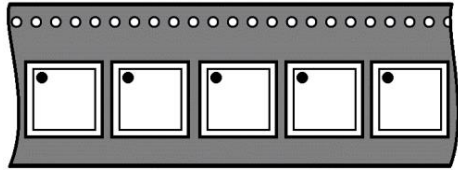
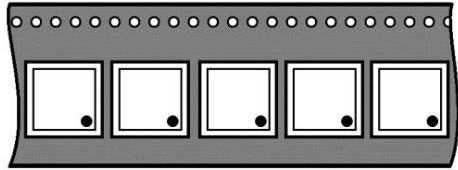
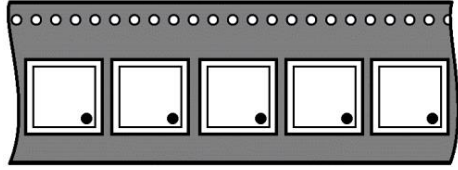
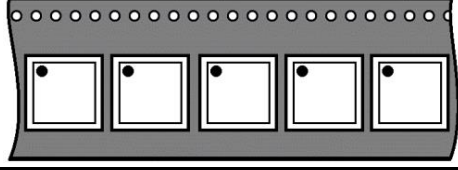
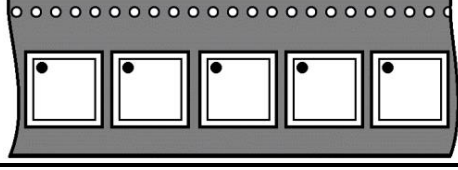
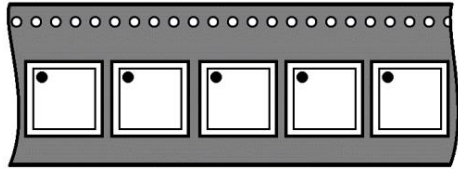
Package	Tape Width mm	Pitch mm	Component Orientation	Reel Diameter		Devices Per Reel or Min Order Quantity	TnR OPN Suffixes
				(mm)	(in)		
SSOP24 (275mil)	16	12	No Available Component Orientation (TBD)	254	10	1,000	For xSanyo Legacy only
SSOP30/SSOP24J/HSSOP16 (275mil)	16	12		254	10	1,000	For xSanyo Legacy only
SOJ40 (400mil)	TBD	TBD	No Available Component Orientation (TBD)	TBD	TBD	1,000	For xSanyo Legacy only
MSOP8/8J/10/12•HMSOP8 (150mil)	TBD	TBD	No Available Component Orientation (TBD)	254	10	2,000	For xSanyo Legacy only
TSSOP20/20J/24 (225mil)	16	8		254	10	1,000	For xSanyo Legacy only
TSSOP30/36 (275mil)	16	8		254	10	1,000	For xSanyo Legacy only
TSOP32DA/DC (8 x 14)	24	12		254	10	1,000	For xSanyo Legacy only
SSOP20/24•HSSOP14(225mil)	12	8		254	10	3,000	For xSanyo Legacy only
MFP8/8J/10SJ/12SJ (200mil)	TBD	TBD	No Available Component Orientation (TBD)	330	12	1,000	For xSanyo Legacy only
MSOP8/20/24 (225mil)	12	8		254	10	2,000	For xSanyo Legacy only

BRD8011

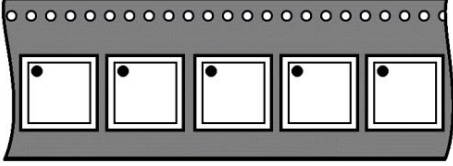
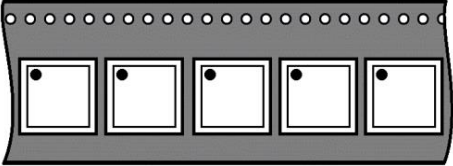
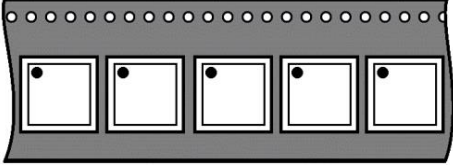
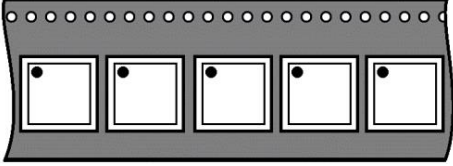
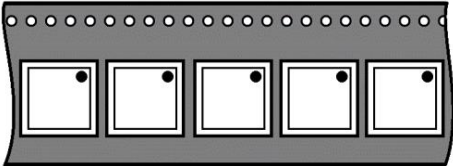
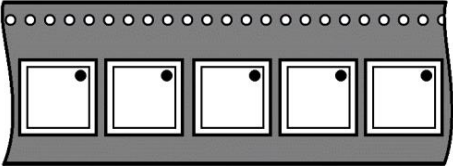
Package	Tape Width mm	Pitch mm	Component Orientation	Reel Diameter		Devices Per Reel or Min Order Quantity	TnR OPN Suffixes
				(mm)	(in)		
MFP8J/10SK (225mil) TAIHEI DENSHI assembled product.	12	8		330	12	1,000	For xSanyo Legacy only
MFP20J (300mil) AOI DENSHI assembled product	24	12	No Available Component Orientation (TBD)	330	12	2,000	For xSanyo Legacy only
MFP24SJ (300mil) J-DEVICES assembled product.	24	12	No Available Component Orientation (TBD)	330	12	2,000	For xSanyo Legacy only
SOIC8/10 except for SOIC8 MSL1 OSPI Assembled product	12	8		330	12	2,500	For xSanyo Legacy only
SOIC8/10 OSPI Assembled product	12	8		330	12	2,500	For xSanyo Legacy only
SOIC16 OSPI Assembled product	16	8		178	7	2,500	For xSanyo Legacy only
SOP8J/8L (200 mil)	TBD	TBD	No Available Component Orientation (TBD)	TBD	TBD	2,000	For xSanyo Legacy only
SQFP48/QFP36 (7 x 7)	16	12		178	7	1,000	For xSanyo Legacy only
SQFP64 (10 x 10)	16	12		254	10	1,000	For xSanyo Legacy only
QIP-44M (10 x 10)	16	12	No Available Component Orientation (TBD)	254	10	1,000	For xSanyo Legacy only

BRD8011

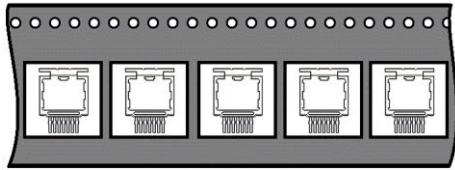
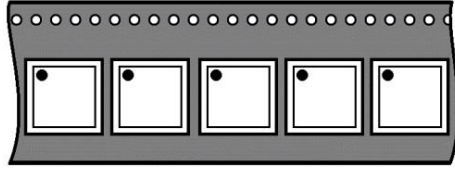
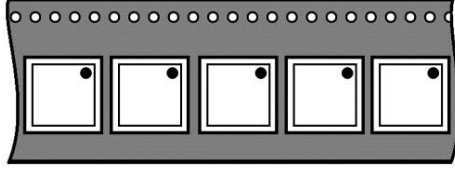
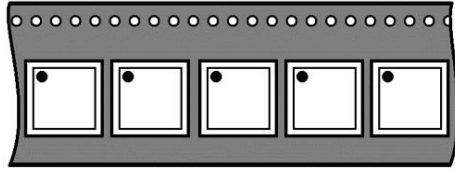
Package	Tape Width mm	Pitch mm	Component Orientation	Reel Diameter		Devices Per Reel or Min Order Quantity	TnR OPN Suffixes	
				(mm)	(in)			
QIP48E/64E · QFP80 (14 x 14)	24	20	No Available Component Orientation (TBD)	254	10	1,000	For xSanyo Legacy only	
QIP80E/100E (14 x 20)	TBD	TBD	No Available Component Orientation (TBD)	TBD	TBD	500	For xSanyo Legacy only	
SQFP80 (12 x 12)	24	20	No Available Component Orientation (TBD)	254	10	1,000	For xSanyo Legacy only	
T2PAK 11.8 x 14	32	16		330	13	800	(NA)	
TLLGA 10 x 10	24	16		330	13	3,000	For xAMIS Legacy only	
TQFP / LQFP / SQFP 7 x 7	16	12		330	13	2,500	For xAMIS Legacy only	
TQFP / LQFP 10 x 10	24	16		330	13	1,500	For xAMIS Legacy only	
TQFP / LQFP 12 x 12 14 x 14	24	20		330	13	1,000	For xAMIS Legacy only	
TQFP-32	16	12		330	13	1,500	For xPulse Core Legacy Only	
TQFP / LQFP 20 x 20 24 x 24	44	32		330	13	750	For xAMIS Legacy only	
TQFP / LQFP / SQFP 7 x 7	16	12			330	13	2,500	For xAMIS Legacy only
TQFP / LQFP 10 x 10	24	16			330	13	1,500	For xAMIS Legacy only

BRD8011

Package	Tape Width mm	Pitch mm	Component Orientation	Reel Diameter		Devices Per Reel or Min Order Quantity	TnR OPN Suffixes	
				(mm)	(in)			
TQFP / LQFP 12 x 12 14 x 14	24	20		330	13	1,000	For xAMIS Legacy only	
TQFP / LQFP 20 x 20 24 x 24	44	32		330	13	750	For xAMIS Legacy only	
TSOP-5	8	4		178	7	3,000	T2	
TSSOP 4.4 14/16	12	12		330	13	4,000	For xAMIS Legacy only	
TSSOP-EP 14/16	12	12				2,500		
TSSOP-8	12	8				4,000		
TSSOP-8	12	8				2,500		
TSSOP-8	12	8				4,000	5,000	For xCatalyst Legacy Only
TSSOP-14	12	8				4,000	4,000	For xAMIS Legacy only
TSSOP-16	12	8				2,000	2,000	For xCatalyst Legacy Only
TSSOP-20	16	8				2,000	2,000	
TSSOP-24	16	8				2,500	2,500	For xAMIS Legacy only
TSSOP-24	16	8				2,000	2,000	For xCatalyst Legacy Only
TSSOP-28	16	8				3,000	3,000	For xAMIS Legacy only
TSSOP-28	16	8				4,000	4,000	
TSSOP-48	24	12					330	13

BRD8011

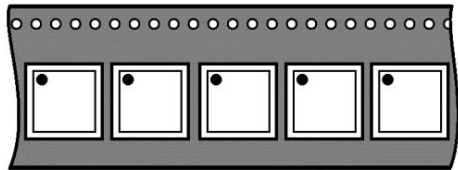
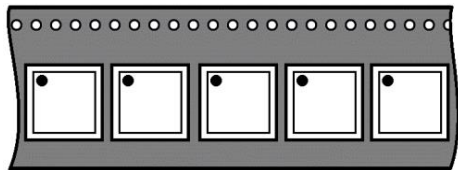
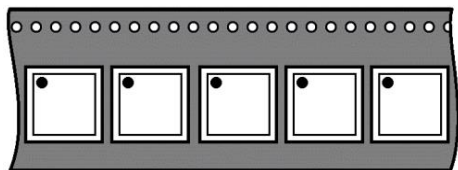
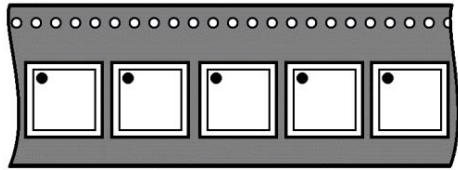
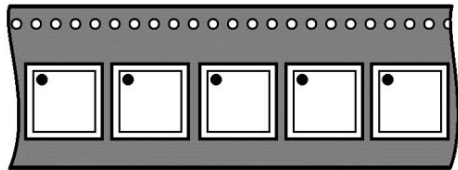
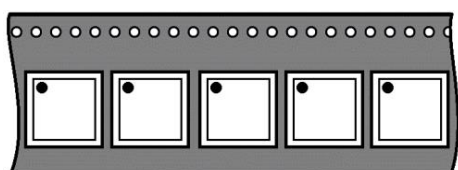
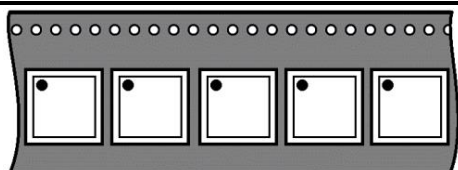
Package	Tape Width mm	Pitch mm	Component Orientation	Reel Diameter		Devices Per Reel or Min Order Quantity	TnR OPN Suffixes
				(mm)	(in)		
TSSOP 4 / Micro-DIP 4.975 x 4.375 5.0 x 4.4	12	8	No Available Component Orientation (TBD)	330	13	4,000	For xFSC Legacy only
TSSOP 48	24	12		330	13	1,000	For xFSC Legacy only
TSSOP 56	24	12		330	13	1,000	For xFSC Legacy only
TSSOP 14 WB	12	8		330	13	2,500	For xFSC Legacy only
TSSOP 16	12	8		330	13	2,500	For xFSC Legacy only
TSSOP 20	16	8		330	13	2,500	For xFSC Legacy only
TSSOP 24	16	8		330	13	2,500	For xFSC Legacy only
TSSOP 28	16	8		330	13	2,500	For xFSC Legacy only

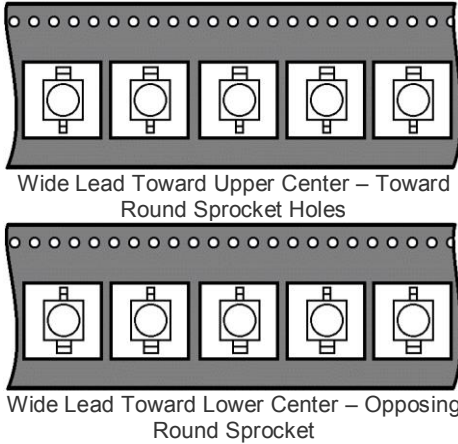
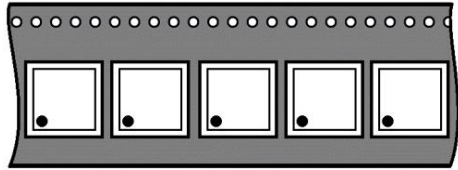
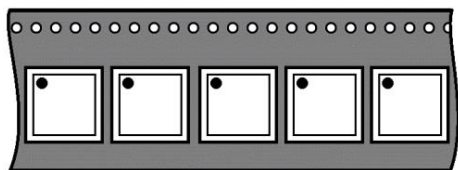
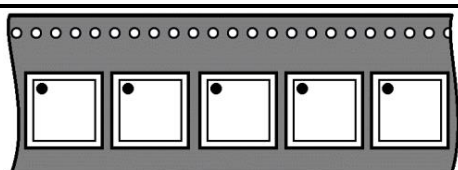
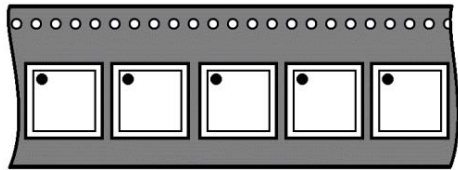
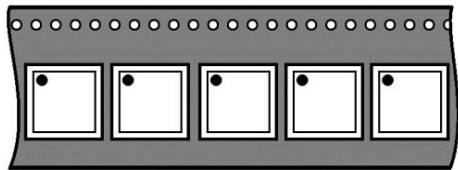

BRD8011

Package	Tape Width mm	Pitch mm	Component Orientation	Reel Diameter		Devices Per Reel or Min Order Quantity	TnR OPN Suffixes
				(mm)	(in)		
TOPLOOKER T-3/4, 2.50 x 2.00	12	4	 <p>Wide Lead Toward Upper Center – Toward Round Sprocket Holes</p> <p>Wide Lead Toward Lower Center – Opposing Round Sprocket</p>	178	7	1,000	For xFSC Legacy only
UDFN 1.0 x 1.0 1.6 x 1.6 1.6 x 2.1	8	4		178	7	5,000	For xFSC Legacy only
UDFN 1.4 x 1.2 1.4 x 1.8 1.6 x 1.6 1.7 x 2.0 1.8 x 1.8 1.8 x 2.6 2.5 x 3.4	8	4		178	7	5,000	For xFSC Legacy only
UDFN 2.0 x 2.0	8	4		178	7	3,000	For xFSC Legacy only
UDFN 3.0 x 3.0 3.0 x 4.0	12	8		330	13	3,000	For xFSC Legacy only
UDFN 1.6 x 1.6	8	4		178	7	3,000	For xAMIS Legacy only

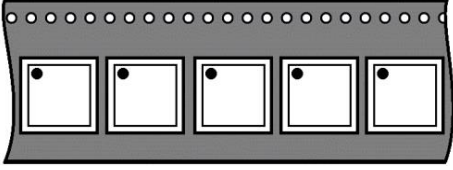
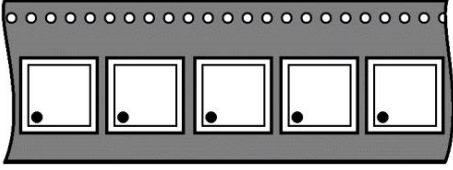
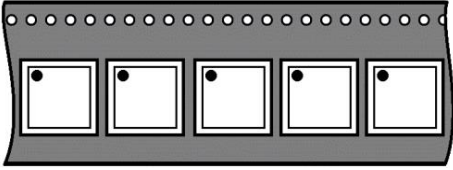
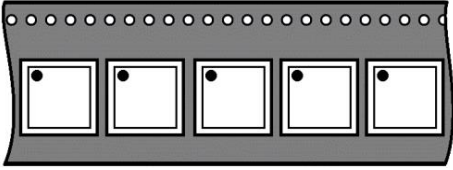
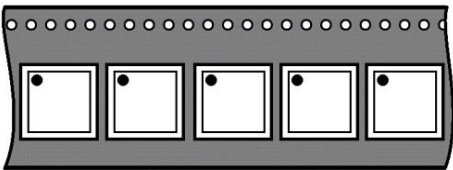
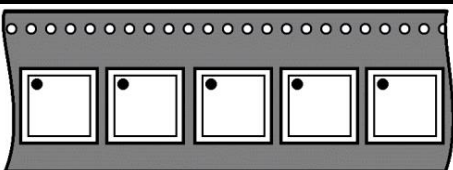
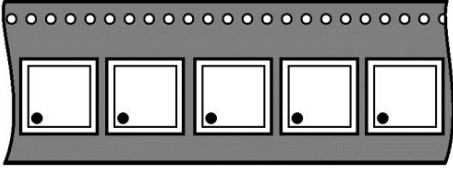
BRD8011

Package	Tape Width mm	Pitch mm	Component Orientation	Reel Diameter		Devices Per Reel or Min Order Quantity	TnR OPN Suffixes
				(mm)	(in)		
UDFN 1.6 x 1.6	8	4		178	7	5,000	-
US8	8	4		178	7	3,000	US
				330	13	10,000	UST3
UQFN 3 x 3	12	8		330	13	3,000	For xAMIS Legacy only
UQFN 2.4 x 4.5	12	8		330	13	5,000	
UQFN 2.1 x 1.6	8	4		178	7	3,000	-
UQFN 1.4 x 1.2 1.4 x 1.8 1.7 x 2.0 1.8 x 1.8 1.8 x 2.6 2.5 x 3.4	8	4		178	7	5,000	For xFSC Legacy only
UQFN 3 x 4	12	8		330	13	5,000	For xFSC Legacy only
UQFN 1.6 x 1.6 1.6 x 2.1	8	4		178	7	5,000	For xFSC Legacy only
UQFN 16 3 x 3	12	8	No Available Component Orientation (TBD)	330	13	3,000	For xFSC Legacy only

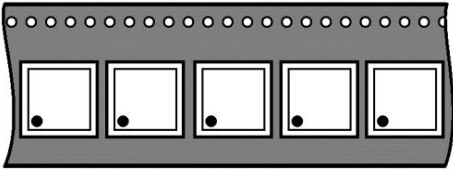
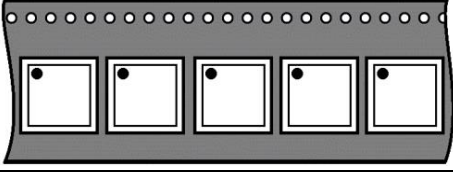
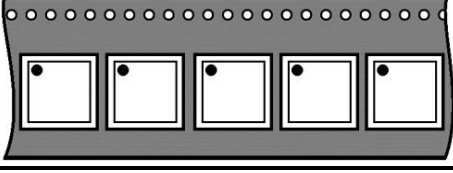
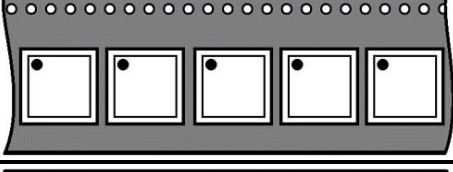
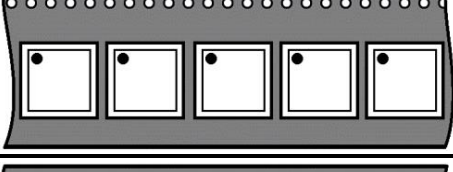
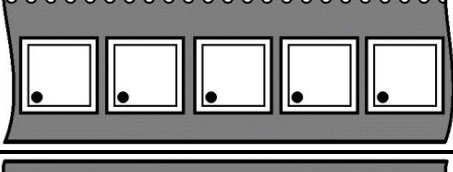
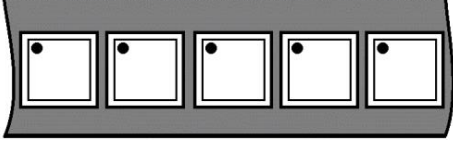
BRD8011

Package	Tape Width mm	Pitch mm	Component Orientation	Reel Diameter		Devices Per Reel or Min Order Quantity	TnR OPN Suffixes
				(mm)	(in)		
UQFN 20 3 x 3	12	8	No Available Component Orientation (TBD)	330	13	5,000	For xFSC Legacy only
US8	8	4		178	7	3,000	For xFSC Legacy only
VFBGA 5 x 5	12	8		330	13	5,000	(NA)
VFBGA/ LFBGA 9 x 9	16	12		330	13	2,500	For xAMIS Legacy only
WDFN 6 2 x 2 3.3 x 3.3	8	4		178	7	3,000	For xFSC Legacy only
WDFN 6 3 x 3	12	8		330	13	3,000	For xFSC Legacy only
WDFN 6 2 x 3	8	4		178	7	3,000	For xFSC Legacy only
WDFN 8 3.0 x 1.9	8	4		178	7	3,000	For xFSC Legacy only
WDFN 8 3.3 x 3.3	8	4		178	7	3,000	For xFSC Legacy only

BRD8011

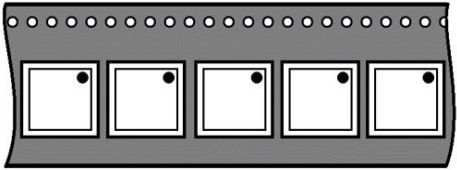
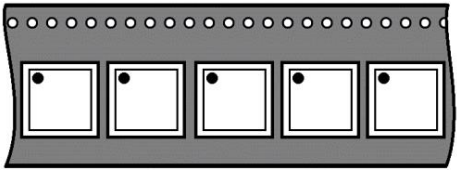
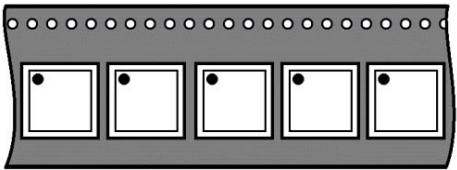
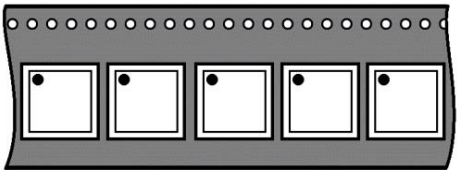
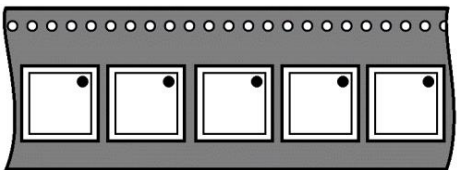
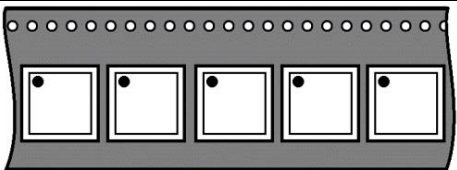
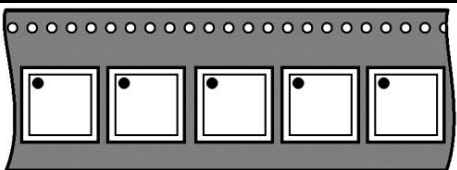
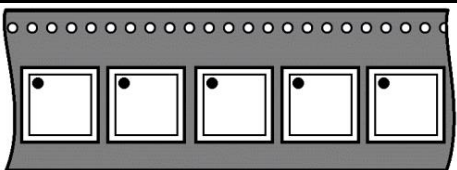
Package	Tape Width mm	Pitch mm	Component Orientation	Reel Diameter		Devices Per Reel or Min Order Quantity	TnR OPN Suffixes
				(mm)	(in)		
WDFN 8 2 x 2	8	4		178	7	3,000	For xFSC Legacy only
WDFN 8 3 x 3 3.3 x 3.3 3 x 4.5 5 x 6	12	8		330	13	3,000	For xFSC Legacy only
WDFN 9 3.3 x 3.3 5 x 6	12	8		330	13	3,000	For xFSC Legacy only
WDFN 10 3 x 3 4 x 4	12	8		330	13	3,000	For xFSC Legacy only
WDFN 10 4 x 3	12	8		330	13	3,000	For xFSC Legacy only
WDFN 12 3.5 x 3 5 x 4.5	12	8		330	13	3,000	For xFSC Legacy only
WDFN 16 3 x 3	12	8		330	13	3,000	For xFSC Legacy only
WDFN 2 x 2	8	4		178	7	3,000	For xPulse Core Legacy Only

BRD8011

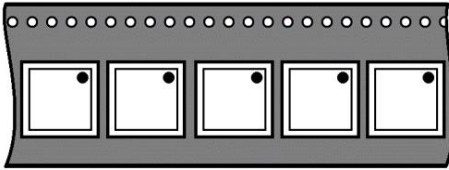
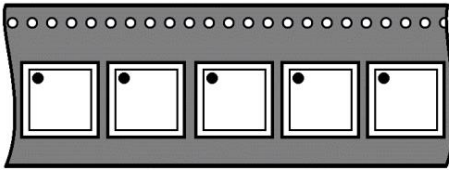
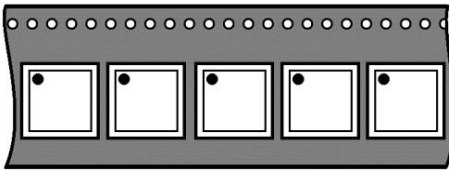
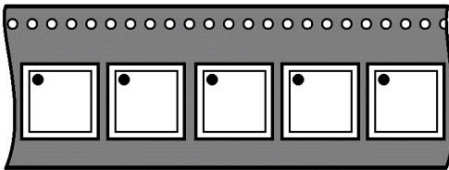
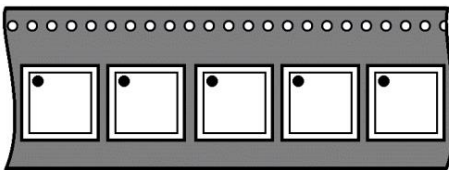
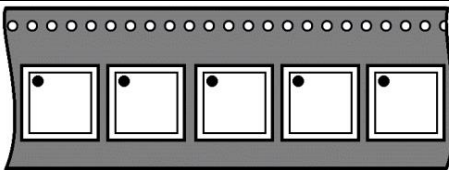
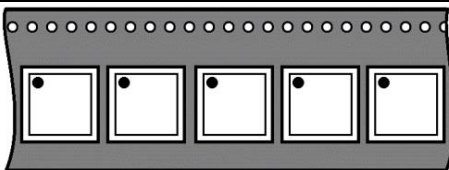
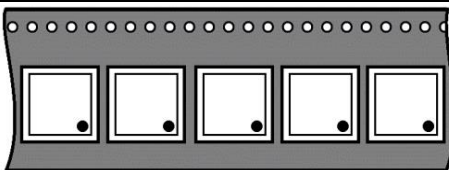
Package	Tape Width mm	Pitch mm	Component Orientation	Reel Diameter		Devices Per Reel or Min Order Quantity	TnR OPN Suffixes
				(mm)	(in)		
WDFN 2.5 x 2.0	8	4		178	7	3,000	For xCatalyst Legacy Only
WDFN 2.6 x 4	12	8		330	13	4,000	For xAMIS Legacy only
WDFN 8L 3.3 x 3.3	12	8		330	13	3,000	For xFSC Legacy Only
WDFN 10L 3 x 3	12	8		330	13	2,500	For xPulse Core Legacy Only
WDFN 12L 3 x 3	12	8		330	13	3,000	For xPulse Core Legacy Only
WDFN 4 x 4	12	8		330	13	2,000	For xCatalyst Legacy Only
WDFN 4.5 x 3	12	8		330	13	5,000	For xAMIS Legacy only
WLP6J 1.06 x 1.50	8	4		178	7	5,000	For xSanyo Legacy only

BRD8011

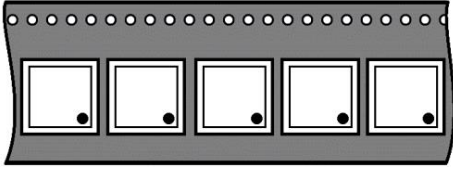
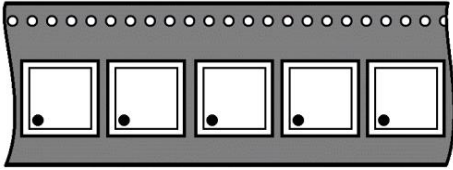
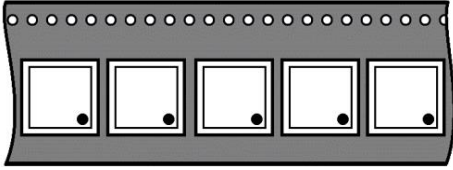
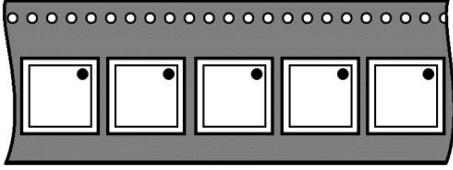
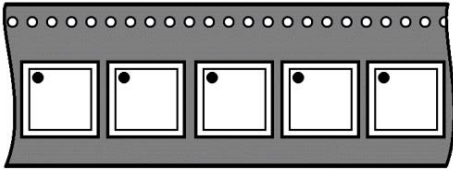
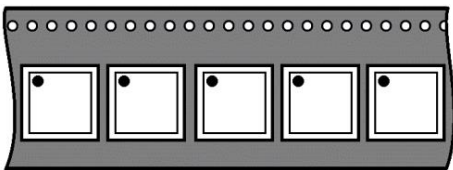
Package	Tape Width mm	Pitch mm	Component Orientation	Reel Diameter		Devices Per Reel or Min Order Quantity	TnR OPN Suffixes
				(mm)	(in)		
WLP4 0.79 x 1.06	8	4		178	7	5,000	For xSanyo Legacy only
WLP179 6.93 x 4.95 6.57 x 4.95	16	8	No Available Component Orientation (TBD)	178	7	1,000	For xSanyo Legacy only
WLP 2.4 x 1.2 x 500	8	4	No Available Component Orientation (TBD)	178	7	5,000	For xSanyo Legacy only
WLCSP 1.96 x 1.84	8	4		178	7	5,000	For xSanyo Legacy only
WLCSP 3.40 x 1.96	12	4		178	7	5,000	For xSanyo Legacy only
WLCSP 2.643 x 3.053	12	8		330	13	5,000	(NA)
WLCSP 1.848 x 1.884 1.884 x 1.848 2.325 x 2.364 2.419 x 3.004 3.004 x 2.419 3.59 x 2.64	12	8		330	13	5,000	(NA)
WLCSP15 2.15 x 1.55	8	4		178	7	4,000 5,000	For xSanyo Legacy only

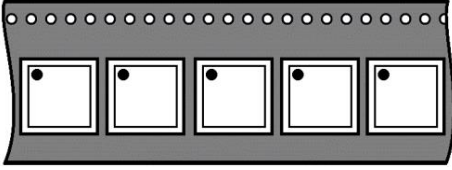
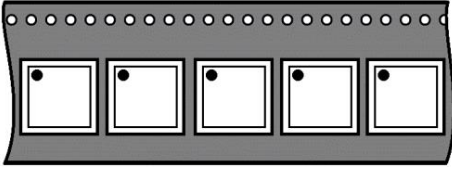
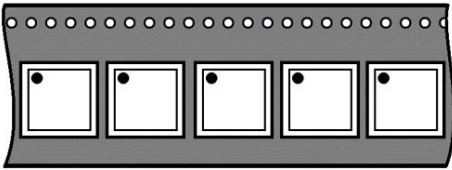
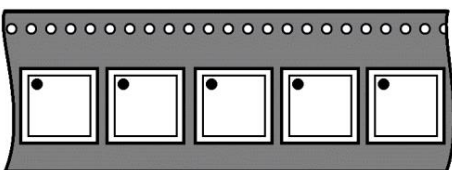
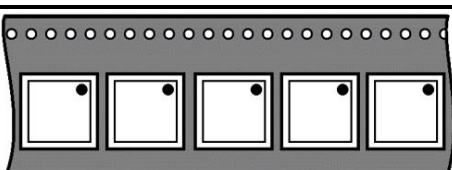
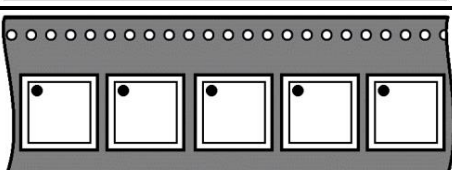
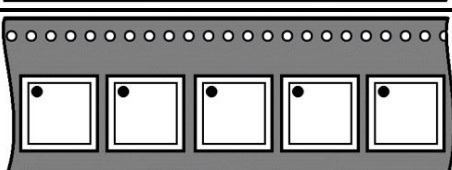
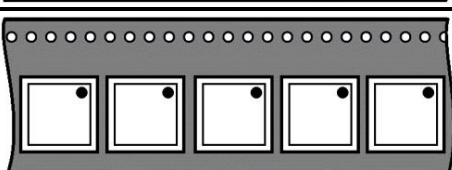

BRD8011

Package	Tape Width mm	Pitch mm	Component Orientation	Reel Diameter		Devices Per Reel or Min Order Quantity	TnR OPN Suffixes
				(mm)	(in)		
WLCSP9 / WLP9 1.31 x 1.31 1.39 x 1.21 1.47 x 1.47 1.60 x 1.76	8	4		178	7	5,000	For xSanyo Legacy only
WLCSP 3-Bump 0.940 x 0.77	8	4		178	7	4,000	For xFSC Legacy only
WLCSP 4-Bump 0.626 x 0.609 0.862 x 0.609 0.964 x 0.609 1.009 x 0.609	8	4		178	7	4,000	For xFSC Legacy only
WLCSP 6-Bump 1.097 x 0.622	8	4		178	7	4,000	For xFSC Legacy only
WLCSP 6 0.86 x 1.75	8	4		178	7	4,000	For xSanyo Legacy
UDFN 1.6 x 1.6	8	4		178	7	3,000	For xAMIS Legacy only
WLCSP 8-Bump 0.652 x 0.834 0.722 x 0.879	8	4		178	7	4,000	For xFSC Legacy only
WLCSP 8 0.97 x 2.25	8	4		178	7	4,000	For xSanyo Legacy

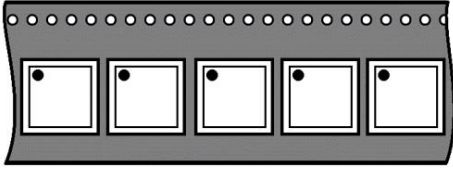
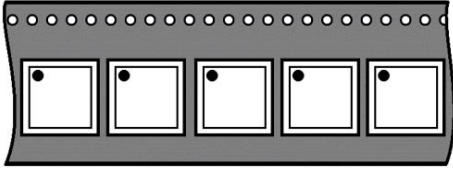
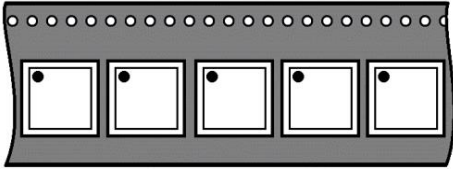
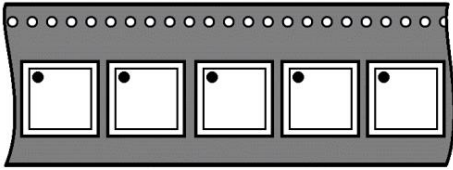
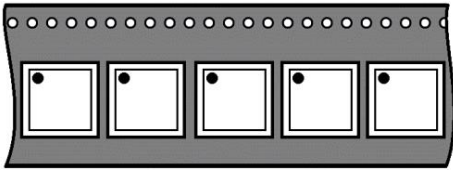
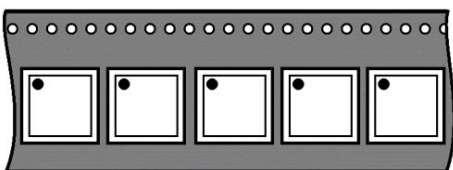
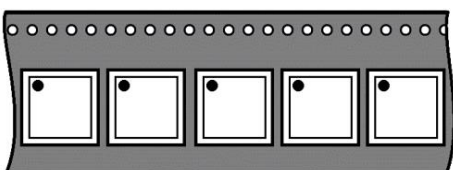
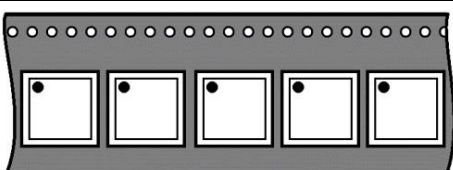
BRD8011

Package	Tape Width mm	Pitch mm	Component Orientation	Reel Diameter		Devices Per Reel or Min Order Quantity	TnR OPN Suffixes
				(mm)	(in)		
WLCSP 10-Bump 0.722 x 1.029	8	4		178	7	4,000	For xFSC Legacy only
WLCSP 12-Bump 0.652 x 1.134 0.722 x 1.179 1.578 x 1.025	8	4		178	7	4,000	For xFSC Legacy only
						3,000	
WLCSP ≤ 0.86 x 0.84	8	2		178	7	5,000	For xFSC Legacy only
WLCSP ≤ 1.4 x 1.4	8	2		178	7	See Data Sheet	For xFSC Legacy only
WLCSP 51 2.323 x 2.364	12	8		330	13	5,000	For xFSC Legacy only
WLCSP ≤ 3.3 x 3.3	8	4		178	7	See Data Sheet	Various For xFSC Legacy only
				330	13		
WLCSP > 3.3 x 3.3 ≤ 7 x 7	12	8		178	7	See Data Sheet	Various For xFSC Legacy only
				330	13		
WLCSP > 7 x 7 mm ≤ 8 x 8 mm	12	16		178	7	See Data Sheet	Various For xFSC Legacy only
				330	13		

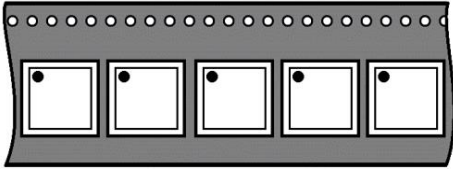
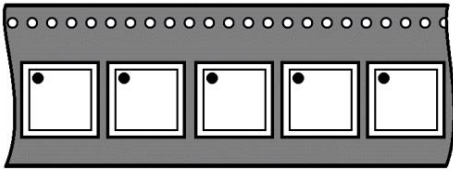
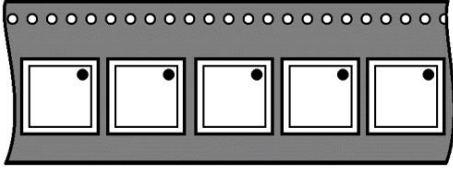
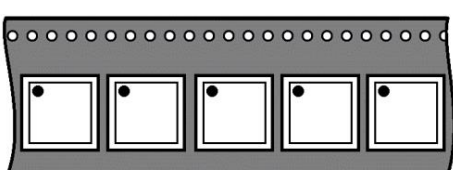
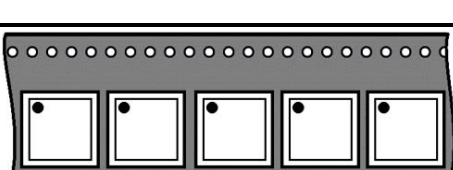
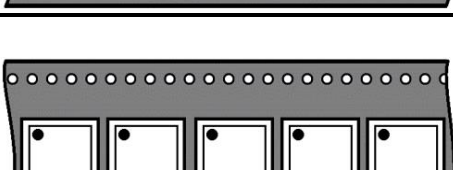
BRD8011

Package	Tape Width mm	Pitch mm	Component Orientation	Reel Diameter		Devices Per Reel or Min Order Quantity	TnR OPN Suffixes
				(mm)	(in)		
WLCSP > 8 x 8 mm ≤ 10.5 x 10.5	16	12		178	7	See Data Sheet	Various For xFSC Legacy only
				330	13		
WLCSP <10.5 x 10.5	16	16		178	7	See Data Sheet	Various For xFSC Legacy only
				330	13		
WLCSP 12 1.235x1.625x0.586 1.288x1.828x0.586	8	4		178	7	3,000	For xFSC Legacy only
WLCSP 12 1.07x1.36x0.432 1.56x1.16x0.586 1.615x1.31x0.586 1.615x1.415x0.586 1.66x1.42x0.5 1.86x1.44x0.586 1.8x1.41x0.5 2.2x1.43x0.582	8	4		178	7	3,000	For xFSC Legacy only
WLCSP 15 1.56x1.56x0.586 2.015x1.31x0.586 2.2x1.6x0.574	8	4		178	7	3,000	For xFSC Legacy only
WLCSP 16 1.56x1.56x0.49 1.56x1.56x0.586 1.615x1.615x0.586 1.61x1.61x0.586 1.71x1.71x0.586 1.71x1.86x0.586 1.78x1.78x0.586 1.81x1.81x0.586 1.96x1.76x0.586	8	4		178	7	3,000	For xFSC Legacy only
WLCSP 20 1.96x1.56x0.586 1.96x1.87x0.586 2.015x1.615x0.586 2.015x1.615x0.586 2.01x1.672x0.586 2.0x1.6x0.586 2.1x1.7x0.586	8	4		178	7	3,000	For xFSC Legacy only

BRD8011

Package	Tape Width mm	Pitch mm	Component Orientation	Reel Diameter		Devices Per Reel or Min Order Quantity	TnR OPN Suffixes
				(mm)	(in)		
WLCSP 25 2.015x2.015x0.586 2.015x2.015x0.586 2.1x2.1x0.586 2.4x2.0x0.586	8	4		178	7	3,000	For xFSC Legacy only
WLCSP 30 2.38x1.98x0.586 2.46x2.26x0.586	8	4		178	7	3,000	For xFSC Legacy only
WLCSP 36 2.36x2.36x0.5	8	4		178	7	3,000	For xFSC Legacy only
WLCSP 4 0.65x0.65x0.298 0.76x0.76x0.586 0.82x0.82x0.586 0.8x0.8x0.5 0.96x0.96x0.582	8	4		178	7	3,000	For xFSC Legacy only
WLCSP 4 0.8 x 0.8 x 0.4 1.4 x 1.6 x 0.35 1 x 1 x 0.582	8	4		178	7	5,000 3,000	For xFSC Legacy only
WLCSP 6/8 0.94x1.5x0.581 1.16x0.76x0.586 1.23x0.88x0.586 1.242x0.842x0.495 1.26x0.86x0.273 1.30x0.9x0.574 1.30x1.05x0.586 1.31x0.96x0.586 1.37x0.97x0.586 1.38x0.94x0.625 1.45x0.95x0.582 1.46x0.96x0.582 1.48x0.98x0.582 1.5x1.0x0.582 1.66x0.96x0.582 1.57x1.57x0.582	8	4		178	7	3,000	For xFSC Legacy only
WLCSP6 1.5 x 1 x 0.6 1 x 1.5 x 0.4 2.3 x 1.3 x 0.35	8	4		178	7	5,000	For xFSC Legacy only

BRD8011

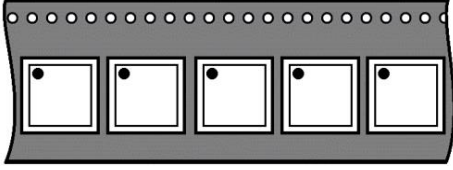
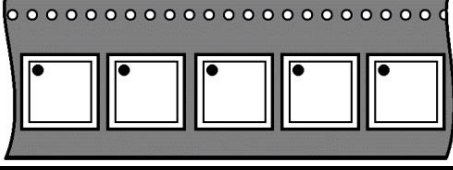
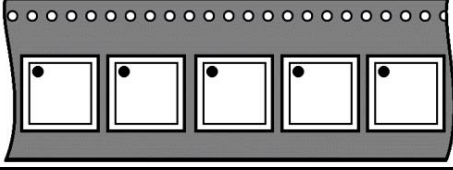
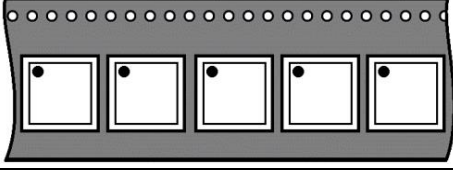
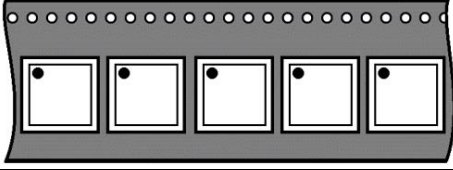
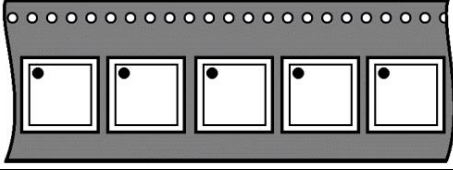
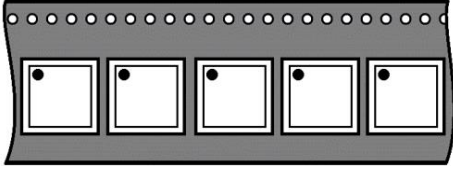
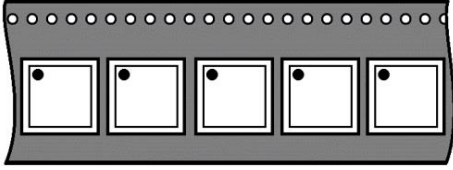
Package	Tape Width mm	Pitch mm	Component Orientation	Reel Diameter		Devices Per Reel or Min Order Quantity	TnR OPN Suffixes
				(mm)	(in)		
WLCSP9 1.16x1.16x0.586 1.215x1.215 1.215x1.26 1.21x1.21 1.26x1.215 1.292x1.342 1.29x1.27 1.385x1.215	8	4		178	7	3,000	For xFSC Legacy only
WQFN 12 3.3 x 3.3	12	8		330	13	3,000	For xFSC Legacy only
WQFN 14 2.5 x 2.5	12	8		330	13	3,000	For xFSC Legacy only
WQFN 16 3.3 x 3.3 3.5 x 2.5	12	8		330	13	3,000	For xFSC Legacy only
WQFN 20 3 x 4 4.5 x 2.5	12	8		330	13	3,000	For xFSC Legacy only
WQFN 24 4 x 4 4.5 x 3.5	12	8		330	13	3,000	For xFSC Legacy only
WQFN 25 6 x 5	12	8		330	13	3,000	For xFSC Legacy only
WQFN 32 5 x 5	12	8		330	13	3,000	For xFSC Legacy only

BRD8011

Package	Tape Width mm	Pitch mm	Component Orientation	Reel Diameter		Devices Per Reel or Min Order Quantity	TnR OPN Suffixes
				(mm)	(in)		
WQFN 40 6 x 6	12	8		330	13	3,000	For xFSC Legacy only
WQFNW33 5 x 5	12	8		330	13	3,000	TW
WQFN-34 SPS 5 x 7	16	8		330	13	4,000	For xFSC Legacy only
WQFNW39 5 x 6	12	8		330	13	3,000	For xFSC Legacy only
WQFN56 7 x 7	16	12		330	13	1,000	For xSanyo Legacy only
						2,500	
XLLGA	8	2		178	7	8,000	TA
X2QFN	8	4		178	7	5,000	For xAMIS Legacy only
X2DFN 6 1 x 1	8	4		330	13	10,000	For xFSC Legacy only

BRD8011

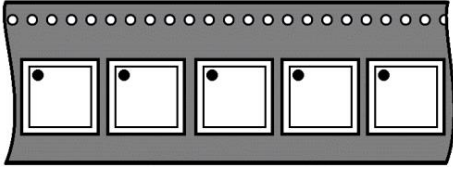
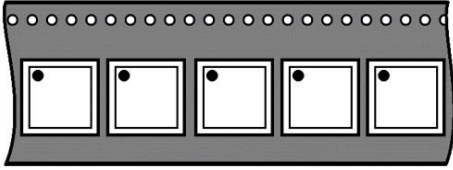
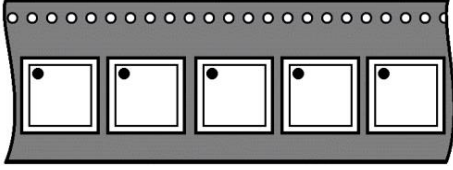
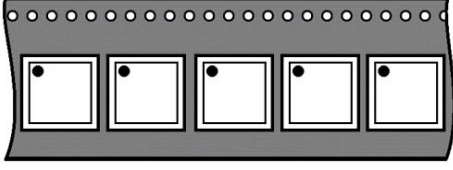
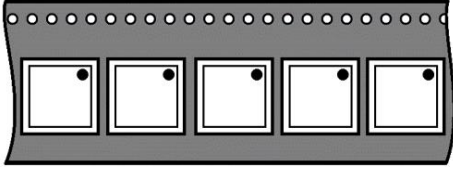
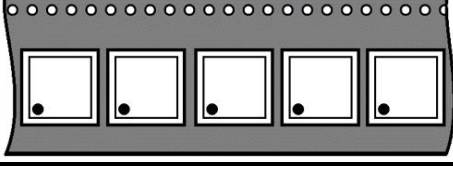
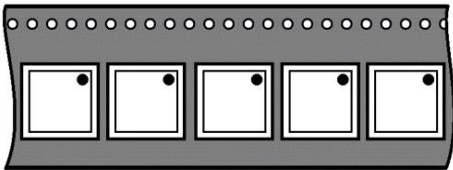
Package	Tape Width mm	Pitch mm	Component Orientation	Reel Diameter		Devices Per Reel or Min Order Quantity	TnR OPN Suffixes
				(mm)	(in)		
X2QFN 10 1.6 x 1.2	8	4		330	13	5,000	For xFSC Legacy only
X2QFN 12 1.6 x 1.6	8	4		178	7	5,000	For xFSC Legacy only
X2QFN 18 2.0 x 2.8	8	4		330	13	5,000	For xFSC Legacy only
XDFN2 (SOD-882) 1 x 0.6	8	4		178	7	8,000	For xFSC Legacy only
							
				330	13	3,000	
SOP8J/8L (200 mil)	12	8	No Available Component Orientation (TBD)	330	13	2,000	For xSanyo Legacy only
SQFP48/QFP36 (7 x 7)	16	12		330	13	1,000	For xSanyo Legacy only

BRD8011

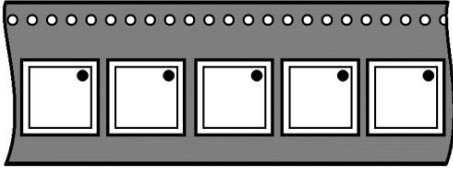
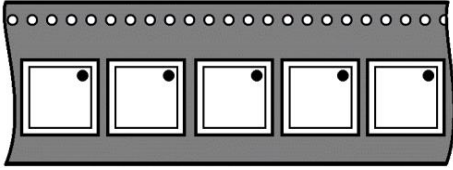
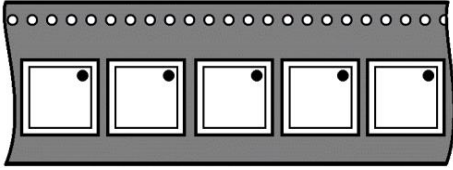
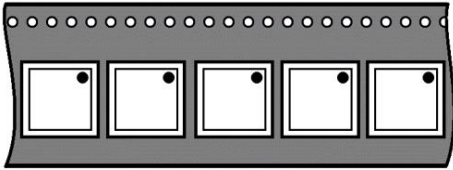
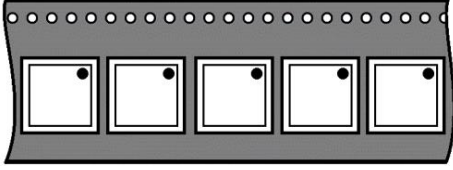
Package	Tape Width mm	Pitch mm	Component Orientation	Reel Diameter		Devices Per Reel or Min Order Quantity	TnR OPN Suffixes
				(mm)	(in)		
SQFP64 (10 x 10)	24	16		330	13	1,000	For xSanyo Legacy only
QIP-44M (10 x 10)	24	16		330	13	1,000	For xSanyo Legacy only
QIP48E/64E · QFP80 (14 x 14)	24	20	No Available Component Orientation (TBD)	330	13	1,000	For xSanyo Legacy only
QIP80E/100E (14 x 20)	44	24	No Available Component Orientation (TBD)	330	13	500	For xSanyo Legacy only
SQFP80 (12 x 12)	24	20	No Available Component Orientation (TBD)	330	13	1,000	For xSanyo Legacy only
TQFP48/48J/48L/64/64J/64K (7 x 7)	16	12		254	10	1,000	For xSanyo Legacy only
FLGA44/FLGA49/J·FBGA64·VQFN28/J/K/N/U·VQFN32/J/K/U·VQLP40 (5.0 x 5.0)	12	8		254	10	2,000	For xSanyo Legacy only
FLGA68/68K (6.0 x 6.0)	16	12	No Available Component Orientation (TBD)	254	10	1,000	For xSanyo Legacy only
VQFN20/20J/24/24J/24K (4.0 x 4.0) WLP56 (3.56 x 4.06)	12	8	No Available Component Orientation (TBD)	254	10	1,000	For xSanyo Legacy only
VQFN28/J/K/N/U/VQFN32/J/K · VQLP40 · FLGA49/49J (5.0 x 5.0)	12	8		254	10	2,000	For xSanyo Legacy only

BRD8011

Package	Tape Width mm	Pitch mm	Component Orientation	Reel Diameter		Devices Per Reel or Min Order Quantity	TnR OPN Suffixes
				(mm)	(in)		
PFBGA89/FBGA89/FBGA89 K/FLGA64/ISB96 (6.0 x 6.0)	12	8	No Available Component Orientation (TBD)	254	10	1,000	For xSanyo Legacy only
VQFN44/44K/44L/40 (6.0 x 6.0)	16	12	No Available Component Orientation (TBD)	254	10	1,000	For xSanyo Legacy only
VQFN52/J (7.0 x 7.0)	16	12	No Available Component Orientation (TBD)	254	10	1,000	For xSanyo Legacy only
VQLP24(3.5 x 3.5) FLGA32/32J (3.5 x 3.5)	12	8	No Available Component Orientation (TBD)	254	10	2,000	For xSanyo Legacy only
VQLP24/32-FLGA49 (4.0 x 4.0)	12	8	No Available Component Orientation (TBD)	254	10	2,000	For xSanyo Legacy only
FLGA64/64J/64K/FBGA49/64 /64J/64K/ISB77/45 (5.0 x 5.0)	12	8	No Available Component Orientation (TBD)	254	10	2,000	For xSanyo Legacy only
FLGA2 4FLGA2 4 (3.0 x 3.0) - VQFN16 (3.0 x 3.0)	12	8	No Available Component Orientation (TBD)	254	10	2,000	For xSanyo Legacy only
VCT16/20-UCT16/20 (2.6 x 2.6)	12	8	No Available Component Orientation (TBD)	254	10	2,000	For xSanyo Legacy only
VCT24/28 (3.5 x 3.5)	TBD	TBD	No Available Component Orientation (TBD)	254	10	2,000	For xSanyo Legacy only
ISB 45 /63 /90 (5.0 x 4.0)	12	8	No Available Component Orientation (TBD)	254	10	2,000	For xSanyo Legacy only
VCT20/24/10 (3.0 x 3.0)	TBD	TBD	No Available Component Orientation (TBD)	254	10	2,000	For xSanyo Legacy only
USLP8 (3.0 x 2.0)	12	8	No Available Component Orientation (TBD)	TBD	TBD	2,000	For xSanyo Legacy only
ISB64/64J/64K/64L (4.35 / 4.35)	12	8	No Available Component Orientation (TBD)	254	10	2,000	For xSanyo Legacy only
ODCSP4 (1.01 x 1.01)	8	2	No Available Component Orientation (TBD)	178	7	5,000	For xSanyo Legacy only
ODCSP4(1.22 x 1.38) ODCSP8(1.35 x 1.23)	8	4	No Available Component Orientation (TBD)	178	7	5,000	For xSanyo Legacy only

BRD8011

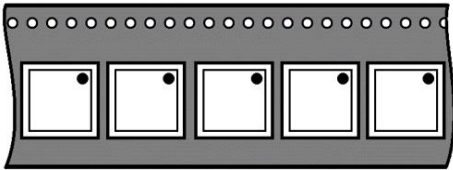
Package	Tape Width mm	Pitch mm	Component Orientation	Reel Diameter		Devices Per Reel or Min Order Quantity	TnR OPN Suffixes
				(mm)	(in)		
FPLG16(5.0 x 4.0)	12	8	No Available Component Orientation (TBD)	254	10	2,000	For xSanyo Legacy only
ODCSP4/J (1.08 x 1.08)	TBD	TBD	No Available Component Orientation (TBD)	178	7	5,000	For xSanyo Legacy only
WLP36/40 (2.97 x 2.97) - UCT 20 (3.0 x 3.0) - WLP46(3.03 x 3.03)	12	8	No Available Component Orientation (TBD)	254	10	2,000	For xSanyo Legacy only
WLP8(1.67X0.87) (1.77x0.87)	12	8	No Available Component Orientation (TBD)	254	10	5,000	For xSanyo Legacy only
WLP10/10J/10K (2.47X0.97)	TBD	TBD	No Available Component Orientation (TBD)	178	7	5,000	For xSanyo Legacy only
WLP25 (2.17X2.17) / (2.17X2.25)	8	4	No Available Component Orientation (TBD)	178	7	5,000	For xSanyo Legacy only
WLP6K (1.27X0.87) WLP6(1.17X0.85) WLCSP6 (0.85x1.17x0.40)	8	4		178	7	5,000	For xSanyo Legacy only
WLP48 (3.57X3.57)	TBD	TBD	No Available Component Orientation (TBD)	254	10	2,000	For xSanyo Legacy only
WLP12 (1.69X1.95)	8	4	No Available Component Orientation (TBD)	178	7	5,000	For xSanyo Legacy only
WLP36 (2.87X2.47)	TBD	TBD	No Available Component Orientation (TBD)	178	7	4,000	For xSanyo Legacy only
ODCSP10 (2.57X1.79) ODCSP16 (2.50X2.12)	8	4	No Available Component Orientation (TBD)	178	7	5,000	For xSanyo Legacy only
ODCSP08 (1.75X1.75)	8	4	No Available Component Orientation (TBD)	178	7	4,000	For xSanyo Legacy only
ISB77/180 (7.5X7.5)	16	12	No Available Component Orientation (TBD)	254	10	1,000	For xSanyo Legacy only
WLP32/32K/32L (2.47X2.47)	8	4	No Available Component Orientation (TBD)	178	7	5,000	For xSanyo Legacy only

BRD8011

Package	Tape Width mm	Pitch mm	Component Orientation	Reel Diameter		Devices Per Reel or Min Order Quantity	TnR OPN Suffixes
				(mm)	(in)		
WLP18 (2.08X1.78)	8	4	No Available Component Orientation (TBD)	178	7	4,000	For xSanyo Legacy only
ISB96 (5.48X5.48)	12	8	No Available Component Orientation (TBD)	254	10	2,000	For xSanyo Legacy only
WLP6 (0.80X1.20) WLP6 (1.17X0.77) WLFCP6 (0.80X1.20)	8	2	No Available Component Orientation (TBD)	178	7	5,000	For xSanyo Legacy only
ODCSP10 (2.0X1.28)	8	4	No Available Component Orientation (TBD)	178	7	4,000	For xSanyo Legacy only
VSON8 (4.0X3.0) WBGA35 (4.0X3.0)	12	8	No Available Component Orientation (TBD)	254	10	2,000	For xSanyo Legacy only
FPLG16 (2.55X4.0)	12	8	No Available Component Orientation (TBD)	254	10	2,000	For xSanyo Legacy only
WLP25 (2.07X2.07)	TBD	TBD	No Available Component Orientation (TBD)	178	7	4,000	For xSanyo Legacy only
WLP48 (3.22X2.57)	8	4	No Available Component Orientation (TBD)	178	7	4,000	For xSanyo Legacy only
ODCSP8 (1.45X1.45)	8	4	No Available Component Orientation (TBD)	178	7	5,000	For xSanyo Legacy only
WLP9/9J/9K (1.47X1.47) WLP8K (1.49X1.49)	8	4	No Available Component Orientation (TBD)	178	7	5,000	For xSanyo Legacy only
WLP9 (1.39X1.21) WLP9(1.31X1.31)	TBD	TBD	No Available Component Orientation (TBD)	178	7	5,000	For xSanyo Legacy only
FPLG16 (2.55X3.1)	8	4	No Available Component Orientation (TBD)	254	10	3,000	For xSanyo Legacy only
FLGA24 (3.0X3.0) VQFN16/16J (3.0X3.0)	12	8	No Available Component Orientation (TBD)	330	13	2,000	For xSanyo Legacy only
VCT24/28 (3.5 x 3.5)	12	8	No Available Component Orientation (TBD)	330	13	2,000	For xSanyo Legacy only
WLFCP8 (1.11X1.01)	8	4	No Available Component Orientation (TBD)	178	7	5,000	For xSanyo Legacy only

Appendix

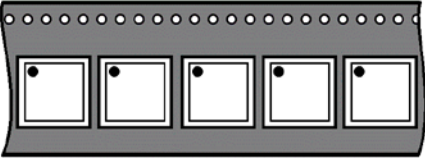
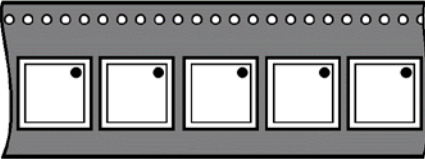
Engineering Package Family	Packing Orientation	TnR Component Orientation
LLGA; LFBGA; LGA UQFN; DFNW; QFN; WDFN; UDFN; CUDFN; QSOP; IBGA; SPQFP; NQFP; BGA; PDIP; XLLGA; LQFP; WLCSP; DFN; XDFN; XDFNW; FCBGA; MICRO; MSOP; SOEIAJ; SOIC; SOICW; SOP; SSOP; TSSOP; TSSOPW; CLCC; U8FL; CSP		REEL Pin 1 Toward Upper Left P1-UL
WLCSP; MOD; XXFN; FDCA; DFN; TQFP; LQFP; CPH; SC- 74; SC-82FL; SC-88; SC-88FL; SC- 74A; SC- 88A; SOIC; SOT- 23; TSOP; SOT-563; ; SOT-963; SOT; SOT- 953; DFNW; LLGA; WDFN; CPH; SOT; LFCSP; QFN; UDFN; UQFN; XDFN; X2DFN; SIP; BGA; LFBGA, GAQFN, FLIP CHIP; CWDFN; SPM5		REEL Pin 1 Toward Upper Right P1-UR

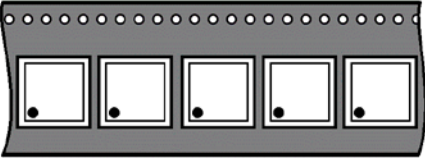
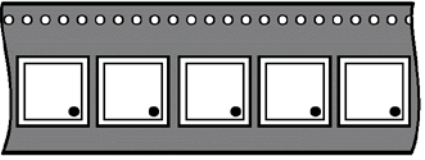
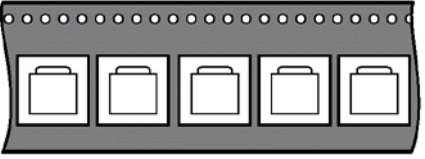
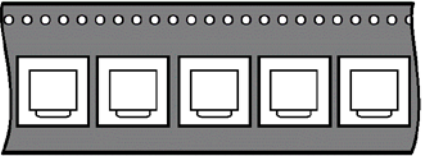
Engineering Package Family	Packing Orientation	TnR Component Orientation
CPH; CHIPFET; PQFP; MFP; PDIP; SOIC; SSOP; SON; SIP; SC-70; SC-82; SC-88; SC-88A; SC-88FL; SC-88AFL; SC-74A; SC-74; SOT-23; SOT; SOT-23; SOT-563; SOT-883; SOT-963; TSOT-23; TSOP; US; ULLGA; UDFN; UQFN; ULL; WDFN; WLCSP; XDFN; X2DFN; XLLGA;		REEL Pin 1 Toward Lower Left P1-LL
XQFP; SC-74R; WLCSP; IBGA; HSOP;		REEL Pin 1 Toward Lower Right P1-LR
D2PAK; DPAK		REEL Heat Sink Toward Upper Center - Towards Round Sprocket Holes HS-UC
D2PAK; POWERFLEX; DPAK; SPAK		REEL Heat Sink Toward Lower Center - Opposing Round Sprocket Holes HS-LC

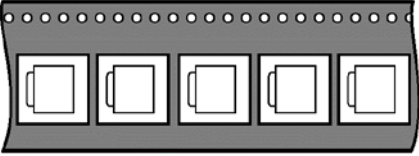
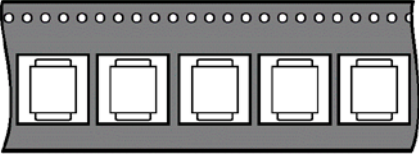
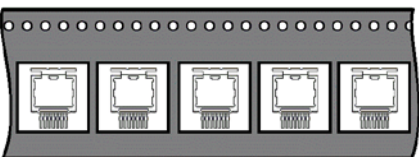
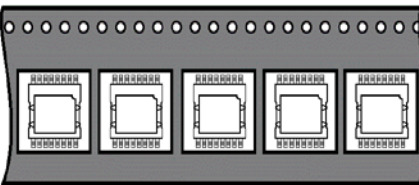
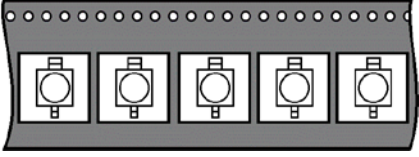
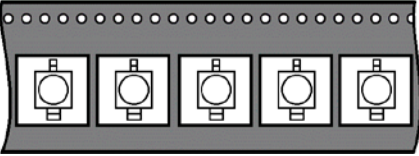
Engineering Package Family	Packing Orientation	TnR Component Orientation
DPAK		REEL Heat Sink Toward Center Left HS-CL
SIP; SMX		REEL Leads Toward Upper and Lower Center LDS-ULC
T2PAK		REEL Leads Toward Lower Center - Opposing Round Sprocket Holes LDS-LC
TCPAK		REEL Pin 1 Toward Upper Right P1-UR
TOPLOOKER		REEL Wide Lead Toward Upper Center - Toward Round Sprocket Holes WLD-UC
TOPLOOKER		REEL Wide Lead Toward Lower Center - Opposing Round Sprocket Holes WLD-LC

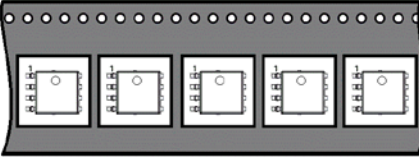
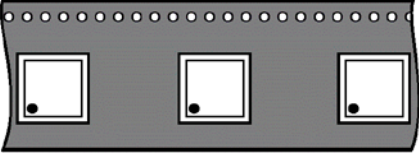
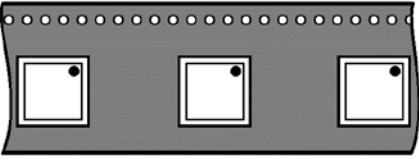
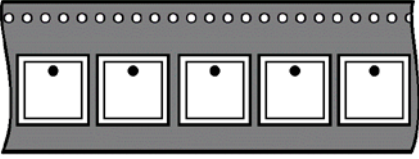
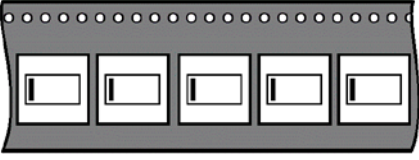
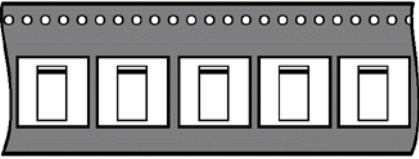
Engineering Package Family	Packing Orientation	TnR Component Orientation
LFPAK		REEL Pin 1 Toward Upper Left P1-UL
SOT-553; SOT-563		REEL Pin 1 Toward Lower Left P1-LL
SOT-553; SOT-563		REEL Pin 1 Toward Upper Right P1-UR
XXFN; PLCC		REEL Pin 1 Toward Upper Center - Toward Round Sprocket Holes P1-UC
SC-82; SC-88A; SOT-563		REEL Polarity Toward Center Left POL-CL
POWERMITE; SMA; SMB; SMC; SOD-123; SOD-323; SOD-123FL; SOD-523; SOD-923; SOD-723; UDFN; XDFN; X3DFN; X2DFNW		REEL Polarity Toward Upper Center - Toward Round Sprocket Holes POL-UC

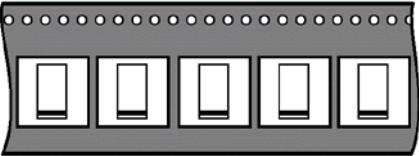
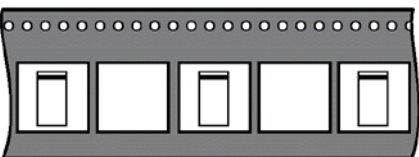
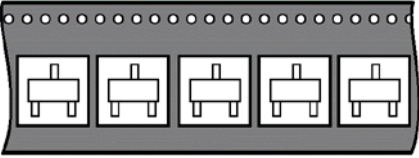
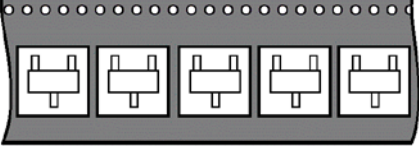
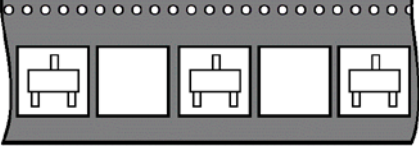
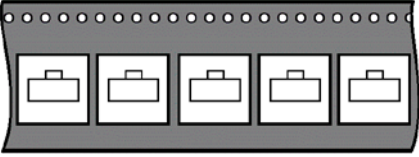
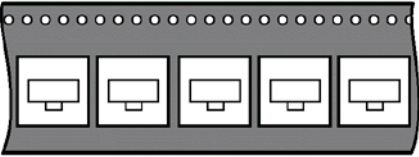
Engineering Package Family	Packing Orientation	TnR Component Orientation
SOD-123; SOD-323		REEL Polarity Toward Lower Center - Opposing Round Sprocket Holes POL- LC
SOD-523; SOD-723; X4DFN; XDFN; XDFN2		REEL Polarity Toward Upper Center - Toward Round Sprocket Holes POL- UC
SOT-723; CPH; SC- 59; SC-75; SC- 89; SOT-23, SOT-23L, SOT-623; SOT-1123		REEL Single Lead Toward Upper Center - Toward Round Sprocket Holes SLD- UC
SC-SOT		REEL Single Lead Toward Lower Center - Opposing Round Sprocket Holes SLD- LC
SOT		REEL Single Lead Toward Upper Center - Toward Round Sprocket Holes SLD- UC
SOT-223; SOT-89		REEL Wide Lead Toward Upper Center - Toward Round Sprocket Holes WLD- UC
SOT-89		REEL Wide Lead Toward Lower Center - Opposing Round Sprocket Holes WLD- LC

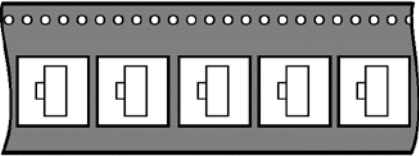
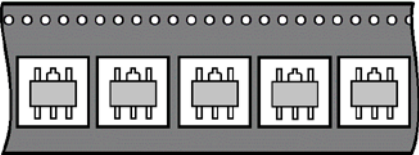
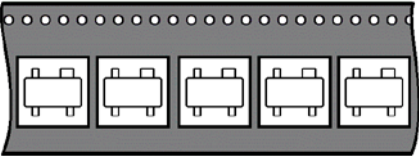
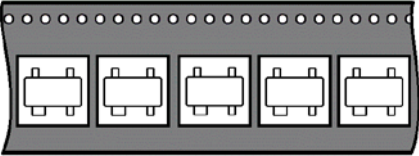
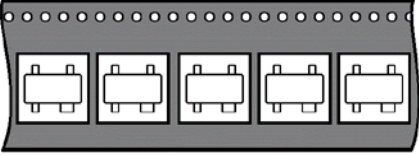
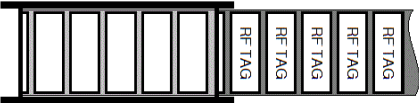
Engineering Package Family	Packing Orientation	TnR Component Orientation
SOT-89		REEL Wide Lead Toward Center Left WLD-CL
SOT-89		REEL Wide Lead Toward Upper Center - Toward Round Sprocket Holes WLD- UC
SOT; SOSM		REEL Wide Lead Toward Upper Right WLD-UR
SOT; SOSM		REEL Wide Lead Toward Lower Left WLD-LL
SOT; SOSM; SC-70; SC-82; SC82A		REEL Wide Lead Toward Lower Right WLD-LR
RFTAG		REEL Widthwise- Underside WW-US

Former CMD Tape and Reel Standards by Package

Package	Package Size (mm)	Tape Width	Reel Diameter	Quantity per Reel	P ₀	P ₁	Orientation Quadrant
CSP, 2-Bump	0.60 x 0.30 x 0.275	8 mm	178 mm (7")	15,000	4 mm	4 mm	Top
CSP, 4-Bump	0.8 x 0.8 x 0.50	8 mm	178 mm (7")	10,000	4 mm	2 mm	B
CSP, 4-Bump	0.8 x 0.8 x 0.60	8 mm	178 mm (7")	5000	4 mm	4 mm	B
CSP, 4-Bump	0.96 x 0.96 x 0.644	8 mm	178 mm (7")	3500	4 mm	4 mm	B
CSP, 4-Bump	0.96 x 0.96 x 0.65	8 mm	178 mm (7")	3500	4 mm	4 mm	B
CSP, 5-Bump	1.05 x 0.76 x 0.615	8 mm	178 mm (7")	3500	4 mm	4 mm	B
CSP, 5-Bump	1.20 x 0.80 x 0.60	8 mm	178 mm (7")	5000	4 mm	4 mm	B
CSP, 5-Bump	1.33 x 0.96 x 0.606	8 mm	178 mm (7")	3500	4 mm	4 mm	A
CSP, 5-Bump	1.33 x 0.96 x 0.644	8 mm	178 mm (7")	3500	4 mm	4 mm	A
CSP, 5-Bump	1.41 x 0.93 x 0.606	8 mm	178 mm (7")	3500	4 mm	4 mm	A
CSP, 5-Bump	1.41 x 0.95 x 0.644	8 mm	178 mm (7")	3500	4 mm	4 mm	A
CSP, 5-Bump	1.59 x 1.22 x 0.64	8 mm	178 mm (7")	3500	4 mm	4 mm	B
CSP, 6-Bump	1.46 x 0.96 x 0.644	8 mm	178 mm (7")	3500	4 mm	4 mm	B
CSP, 6-Bump	1.72 x 1.22 x 0.64	8 mm	178 mm (7")	3500	4 mm	4 mm	B
CSP, 6-Bump	1.804 x 1.154 x 0.644	8 mm	178 mm (7")	3500	4 mm	4 mm	B
CSP, 8-Bump	1.16 x 1.16 x 0.60	8 mm	178 mm (7")	5000	4 mm	4 mm	B
CSP, 8-Bump	1.20 x 1.20 x 0.60	8 mm	178 mm (7")	5000	4 mm	4 mm	B
CSP, 8-Bump	1.43 x 1.41 x 0.605	8 mm	178 mm (7")	3500	4 mm	4 mm	B
CSP, 8-Bump	1.60 x 1.60 x 0.65	8 mm	178 mm (7")	5000	4 mm	4 mm	B
CSP, 9-bump	2.470 x 0.970 x 0.606	8 mm	178 mm (7")	3500	4 mm	4 mm	B
CSP, 9-bump	2.470 x 0.970 x 0.644	8 mm	178 mm (7")	3500	4 mm	4 mm	B
CSP, 10-Bump	1.56 x 1.053 x 0.615	8 mm	178 mm (7")	3500	4 mm	4 mm	B
CSP, 10-Bump	1.67 x 1.11 x 0.615	8 mm	178 mm (7")	3500	4 mm	4 mm	B
CSP, 10-Bump	1.67 x 1.14 x 0.615	8 mm	178 mm (7")	3500	4 mm	4 mm	B
CSP, 10-Bump	1.96 x 1.33 x 0.606	8 mm	178 mm (7")	3500	4 mm	4 mm	B
CSP, 10-Bump	1.96 x 1.33 x 0.644	8 mm	178 mm (7")	3500	4 mm	4 mm	A
CSP, 10-Bump	2.46 x 0.96 x 0.644	8 mm	178 mm (7")	3500	4 mm	4 mm	B
CSP, 10-Bump	3.104 x 1.154 x 0.682	8 mm	178 mm (7")	3500	4 mm	4 mm	B
CSP, 11-Bump	1.46 x 1.96 x 0.65	8 mm	178 mm (7")	5000	4 mm	4 mm	B
CSP, 11-Bump	2.05 x 1.44 x 0.644	8 mm	178 mm (7")	3500	4 mm	4 mm	B
CSP, 14-Bump	2.00 x 1.10 x 0.58	8 mm	178 mm (7")	3500	4 mm	4 mm	B
CSP, 15-Bump	2.36 x 1.053 x 0.262	8 mm	178 mm (7")	3500	4 mm	4 mm	B
CSP, 15-Bump	2.36 x 1.053 x 0.615	8 mm	178 mm (7")	3500	4 mm	4 mm	B
CSP, 15-Bump	2.36 x 1.053 x 0.644	8 mm	178 mm (7")	3500	4 mm	4 mm	B
CSP, 15-Bump	2.47 x 1.11 x 0.615	8 mm	178 mm (7")	3500	4 mm	4 mm	B
CSP, 15-Bump	2.47 x 1.14 x 0.615	8 mm	178 mm (7")	3500	4 mm	4 mm	B
CSP, 15-Bump	2.96 x 1.33 x 0.605	8 mm	178 mm (7")	3500	4 mm	4 mm	B
CSP, 15-Bump	2.96 x 1.33 x 0.615	8 mm	178 mm (7")	3500	4 mm	4 mm	B

BRD8011

Former CMD Tape and Reel Standards by Package

Package	Package Size (mm)	Tape Width	Reel Diameter	Quantity per Reel	P ₀	P ₁	Orientation Quadrant
CSP, 15-Bump	2.96 x 1.33 x 0.644	8 mm	178 mm (7")	3500	4 mm	4 mm	B
CSP, 15-Bump	3.16 x 1.053 x 0.644	8 mm	178 mm (7")	3500	4 mm	4 mm	B
CSP, 15-Bump	3.006 x 1.376 x 0.644	8 mm	178 mm (7")	3500	4 mm	4 mm	B
CSP, 15-Bump	3.01 x 1.38 x 0.644	8 mm	178 mm (7")	3500	4 mm	4 mm	B
CSP, 18-Bump	1.96 x 1.56 x 0.60	8 mm	178 mm (7")	5000	4 mm	4 mm	B
CSP, 20-Bump	3.16 x 1.053 x 0.615	8 mm	178 mm (7")	3500	4 mm	4 mm	B
CSP, 20-Bump	3.27 x 1.11 x 0.615	12 mm	330 mm (13")	3500	4 mm	4 mm	B
CSP, 20-Bump	3.96 x 1.33 x 0.644	8 mm	178 mm (7")	3500	4 mm	8 mm	B
CSP, 20-Bump	3.96 x 1.586 x 0.640	12 mm	330 mm (13")	3500	4 mm	4 mm	B
CSP, 20-Bump	4.00 x 1.46 x 0.605	12 mm	330 mm (13")	3500	4 mm	4 mm	B
CSP, 20-Bump	4.00 x 1.46 x 0.606	12 mm	330 mm (13")	3500	4 mm	8 mm	B
CSP, 20-Bump	4.00 x 1.46 x 0.644	12 mm	330 mm (13")	3500	4 mm	8 mm	B
CSP, 20-Bump	4.006 x 1.376 x 0.644	12 mm	330 mm (13")	3500	4 mm	4 mm	B
CSP, 24-Bump	1.96 x 1.96 x 0.60	8 mm	178 mm (7")	5000	4 mm	4 mm	B
CSP, 24-Bump	2.06 x 2.06 x 0.6	8 mm	178 mm (7")	5000	4 mm	4 mm	B
CSP, 24-Bump	2.60 x 2.60 x 0.65	8 mm	178 mm (7")	500	4 mm	4 mm	B
CSP, 25-Bump	2.00 x 2.00 x 0.60	8 mm	178 mm (7")	500	4 mm	4 mm	B
CSP, 49-Bump	2.80 x 2.80 x 0.50	8 mm	178 mm (7")	500	4 mm	4 mm	B
CSP, 49-Bump	2.80 x 2.80 x 0.60	8 mm	178 mm (7")	500	4 mm	4 mm	B
MSOP-8	3.00 x 3.00 x 0.85	12 mm	330 mm (13")	4000	4 mm	8 mm	A
MSOP-10	3.00 x 3.00 x 0.85	12 mm	330 mm (13")	4000	4 mm	8 mm	A
QSOP-16	4.90 x 3.89 x 1.55	12 mm	330 mm (13")	2500	4 mm	8 mm	A
QSOP-24	8.65 x 3.90 x 1.35	16 mm	178 mm (7")	1000	4 mm	8 mm	A
QSOP-24	8.65 x 3.90 x 1.35	16 mm	330 mm (13")	2500	4 mm	8 mm	A
SC70-3	2.05 x 1.25 x 0.95	8 mm	178 mm (7")	3000	4 mm	4 mm	C
SC70-5	2.05 x 1.25 x 0.95	8 mm	178 mm (7")	3000	4 mm	4 mm	C
SC70-5	2.05 x 1.25 x 0.95	8 mm	178 mm (7")	3000	4 mm	4 mm	C
SC70-6	2.05 x 1.25 x 0.95	8 mm	178 mm (7")	3000	4 mm	4 mm	C
SOD-882	1.00 x 0.60 x 0.50	8 mm	178 mm (7")	5000	4 mm	4 mm	A
SOIC-8	4.90 x 3.99 x 1.55	12 mm	330 mm (13")	2500	4 mm	8 mm	A
SOIC-8	4.90 x 6.00 x 1.55	12 mm	330 mm (13")	2500	4 mm	8 mm	A
SOT143	2.92 x 2.37 x 1.01	8 mm	178 mm (7")	3000	4 mm	4 mm	C
SOT143-4	2.92 x 2.37 x 1.01	8 mm	178 mm (7")	3000	4 mm	4 mm	C
SOT23-3	2.92 x 2.37 x 1.01	8 mm	178 mm (7")	3000	4 mm	4 mm	C
SOT23-5	2.92 x 2.79 x 1.24	8 mm	178 mm (7")	3000	4 mm	4 mm	C
SOT23-6	2.90 x 2.80 x 1.45	8 mm	178 mm (7")	3000	4 mm	4 mm	C
SOT-553	1.60 x 1.60 x 0.55	8 mm	178 mm (7")	5000	4 mm	4 mm	C
SOT-563	1.60 x 1.60 x 0.55	8 mm	178 mm (7")	5000	4 mm	4 mm	C
SOT-593	1.00 x 0.80 x 0.45	8 mm	178 mm (7")	8000	4 mm	4 mm	B
CUDFN-6	1.60 x 1.60 x 0.60	8 mm	178 mm (7")	2500	4 mm	4 mm	A

BRD8011

Former CMD Tape and Reel Standards by Package

Package	Package Size (mm)	Tape Width	Reel Diameter	Quantity per Reel	P ₀	P ₁	Orientation Quadrant
CUDFN-6	2.00 x 2.00 x 0.65	8 mm	178 mm (7")	2500	4 mm	4 mm	A
TDFN-8	1.70 x 1.35 x 0.75	8 mm	178 mm (7")	3000	4 mm	4 mm	A
TDFN-8	2.00 x 2.00 x 0.75	8 mm	178 mm (7")	3000	4 mm	4 mm	A
TDFN-8	3.00 x 3.00 x .075	12 mm	330 mm (13")	3000	4 mm	8 mm	A
TDFN-12	3.00 x 1.35 x 0.75	8 mm	178 mm (7")	3000	4 mm	4 mm	A
TDFN-16	4.00 x 1.60 x 0.75	12 mm	178 mm (7")	3000	4 mm	4 mm	A
TDFN-16	4.00 x 1.70 x 0.75	12 mm	330 mm (13")	3000	4 mm	8 mm	A
TDFN-16	6.00 x 4.00 x 0.75	12 mm	330 mm (13")	3000	4 mm	8 mm	A
TSSOP-8	3.00 x 6.38 x 1.10	12 mm	330 mm (13")	2500	4 mm	8 mm	A
TSSOP-38	9.70 x 6.40 x 1.20	16 mm	330 mm (13")	2500	4 mm	12 mm	A
UDFN-6	1.25 x 1.0 x 0.50	8 mm	178 mm (7")	3000	4 mm	4 mm	A
UDFN-8	1.70 x 1.35 x 0.50	8 mm	178 mm (7")	3000	4 mm	4 mm	A
UDFN-8	1.70 x 1.35 x 0.50	8 mm	178 mm (7")	3000	4 mm	4 mm	A
UDFN-8	2.00 x 2.00 x 0.55	8 mm	178 mm (7")	3000	4 mm	4 mm	A
UDFN-12	2.50 x 1.20 x 0.50	8 mm	178 mm (7")	3000	4 mm	4 mm	A
UDFN-12	2.50 x 1.35 x 0.50	8 mm	178 mm (7")	3000	4 mm	4 mm	A
UDFN-16	3.30 x 1.35 x 0.50	8 mm	178 mm (7")	3000	4 mm	4 mm	A
uUDFN-10	2.50 x 1.00 x 0.50	8 mm	178 mm (7")	3000	4 mm	4 mm	A
X3DFN	0.62 x 0.62 x 0.32	8 mm	178 mm (7")	15,000	2 mm	2 mm	Top

Tape and Reel Dimensions and Orientation for Former CMD Devices

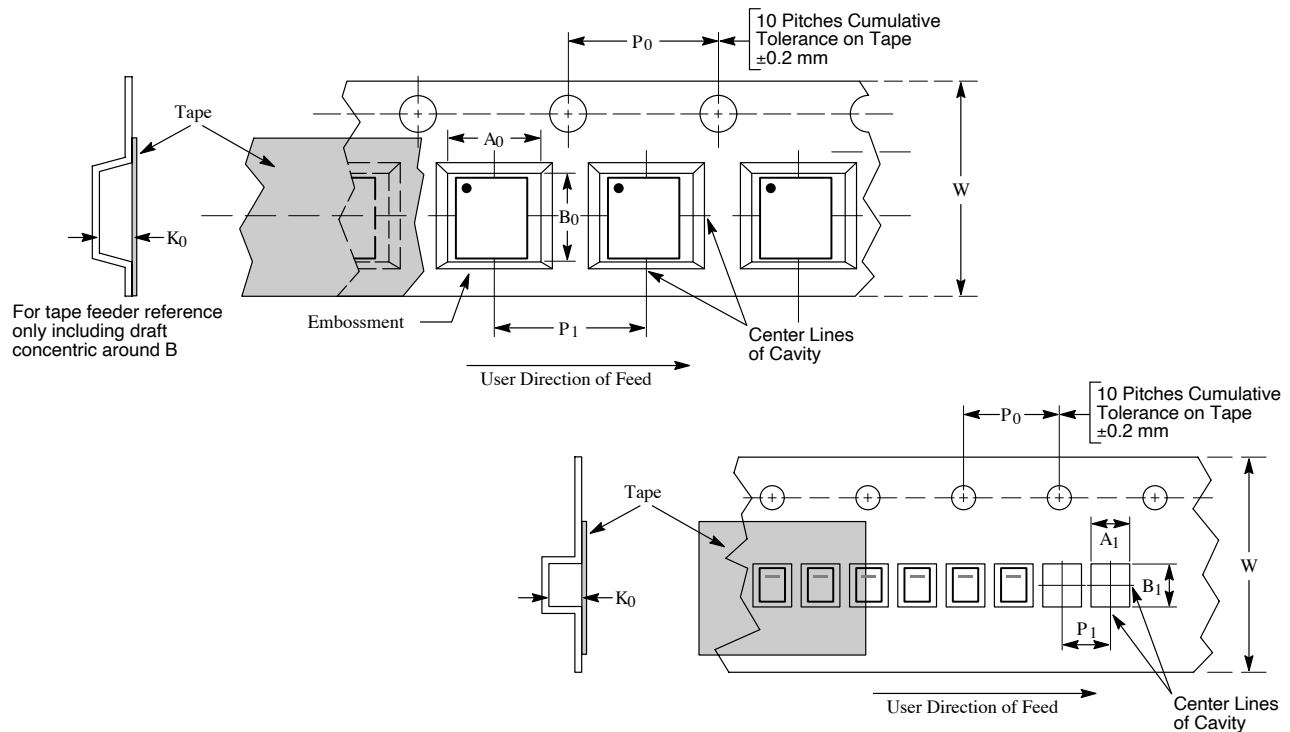

Standard Device Orientation

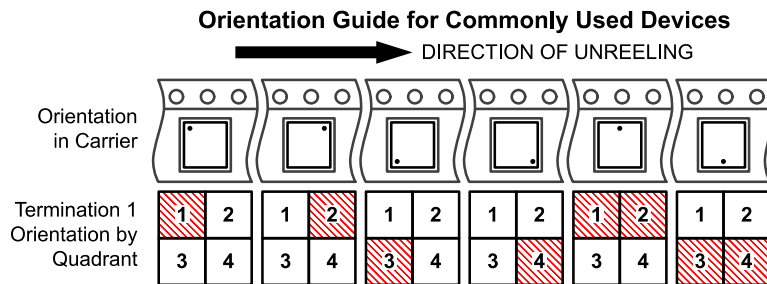

NOTE: Embossed tape that is 8mm, 12mm, 16mm, and 24mm wide has round sprocket holes adjacent to one edge of the tape. Embossed tape that is 32mm, 44mm, 56mm wide has round sprocket holes adjacent to one edge of the tape and they have oval sprocket holes on the opposite edges of the tape.

Pin 1 orientation illustration. Each package family has a unique feature, which identifies the location of pin 1. The following illustration indicates the standard orientation of product in embossed tape.

Non-standard configurations, not illustrated, are customer specific and are described in the appropriate onsemi documents defining customer-documented requirements.

Component Orientation and Quadrant Designations (EIA-481-E)

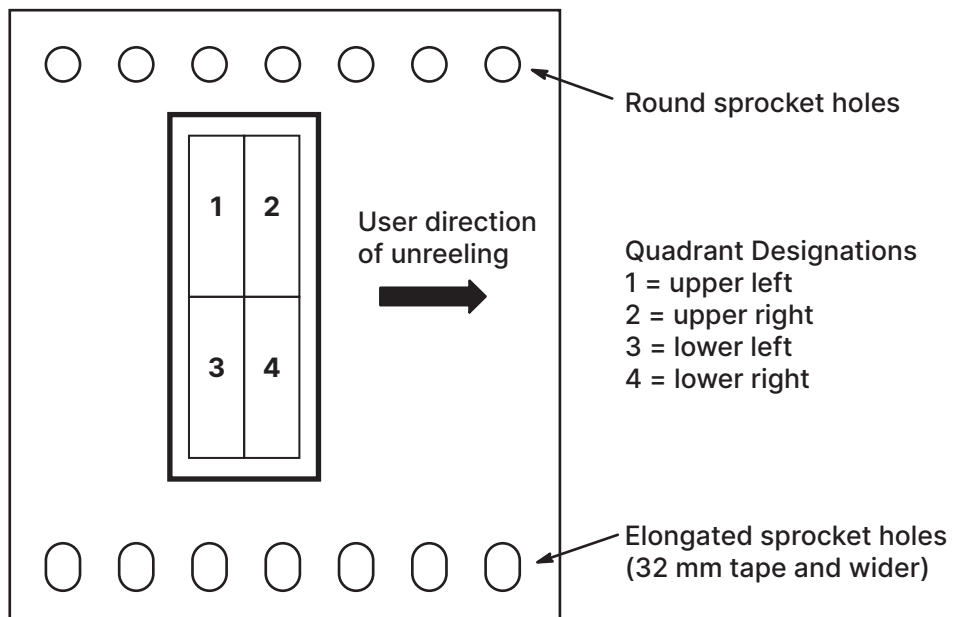
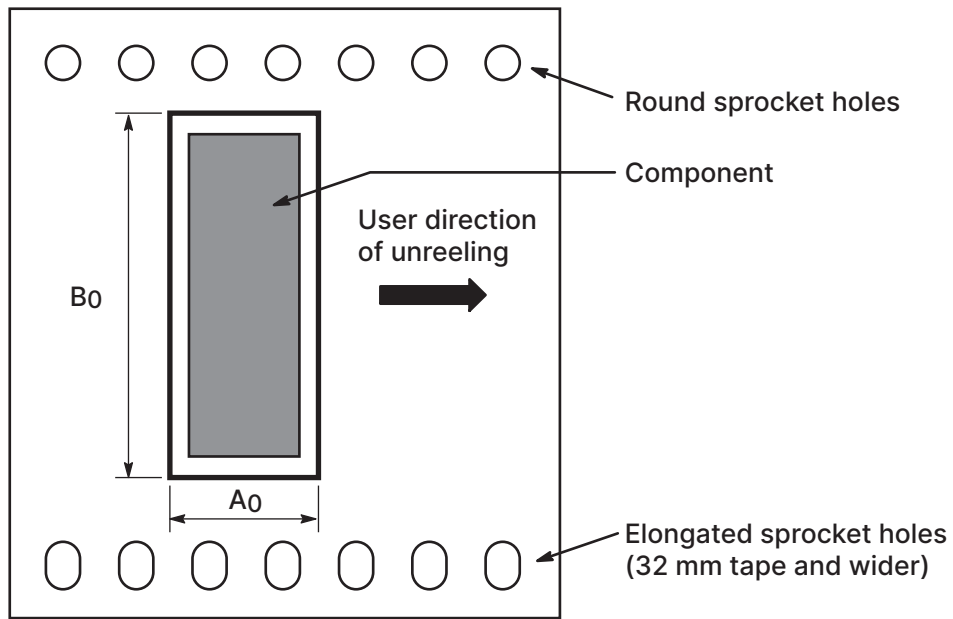

Rules for determining orientation of component in tape pocket, EIA-481-E (1 of 2)

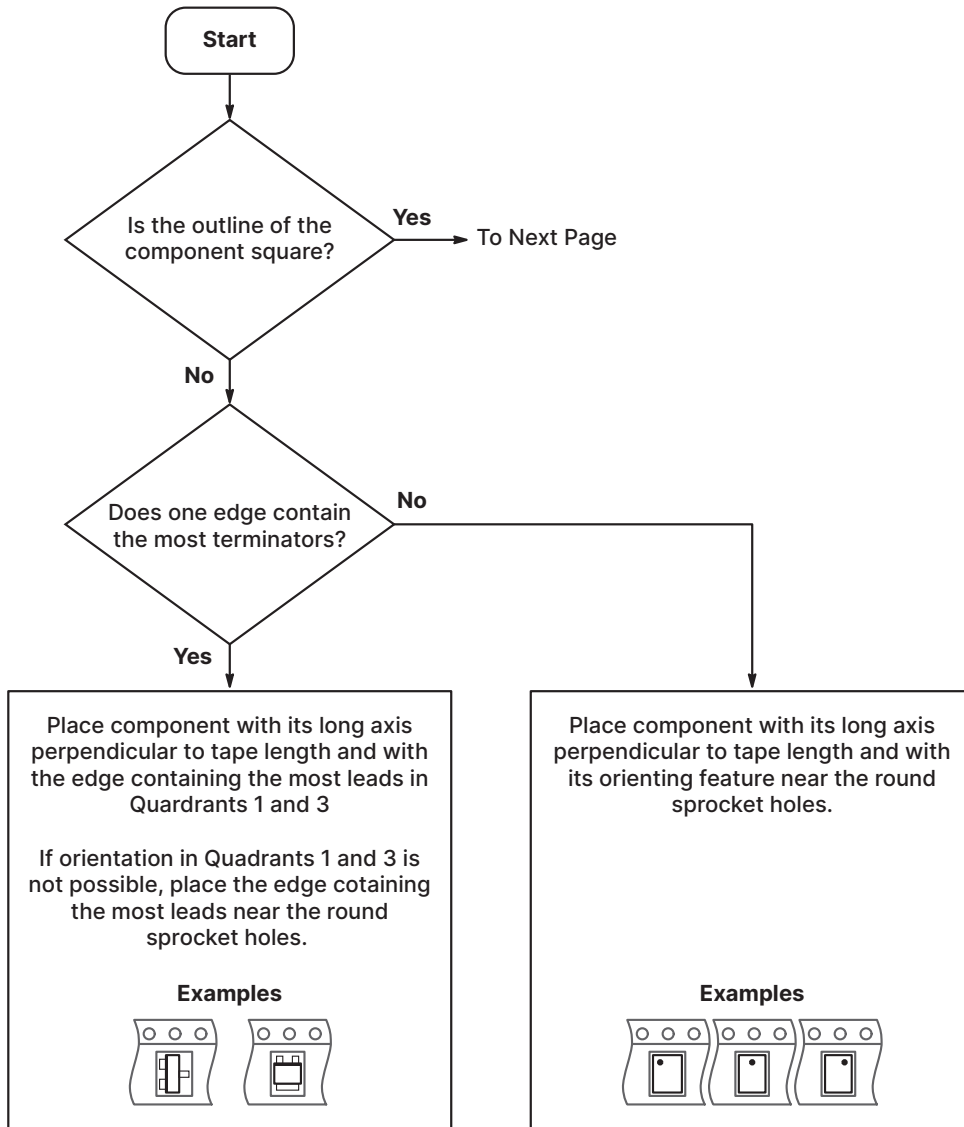

Rules for determining orientation of component in tape pocket, EIA-481-E (2 of 2)

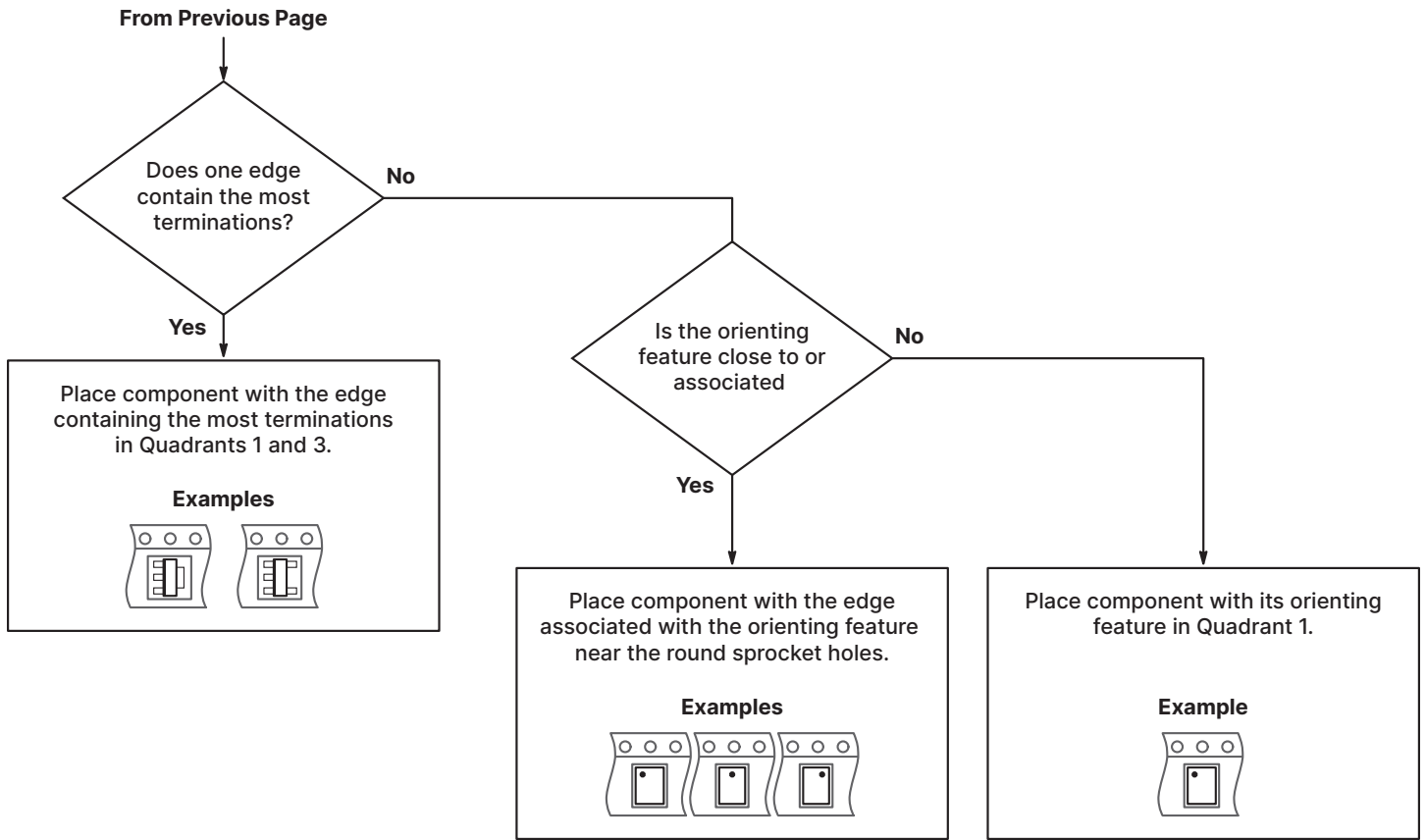

Product Orientation per EIA-481 Quadrant Designation

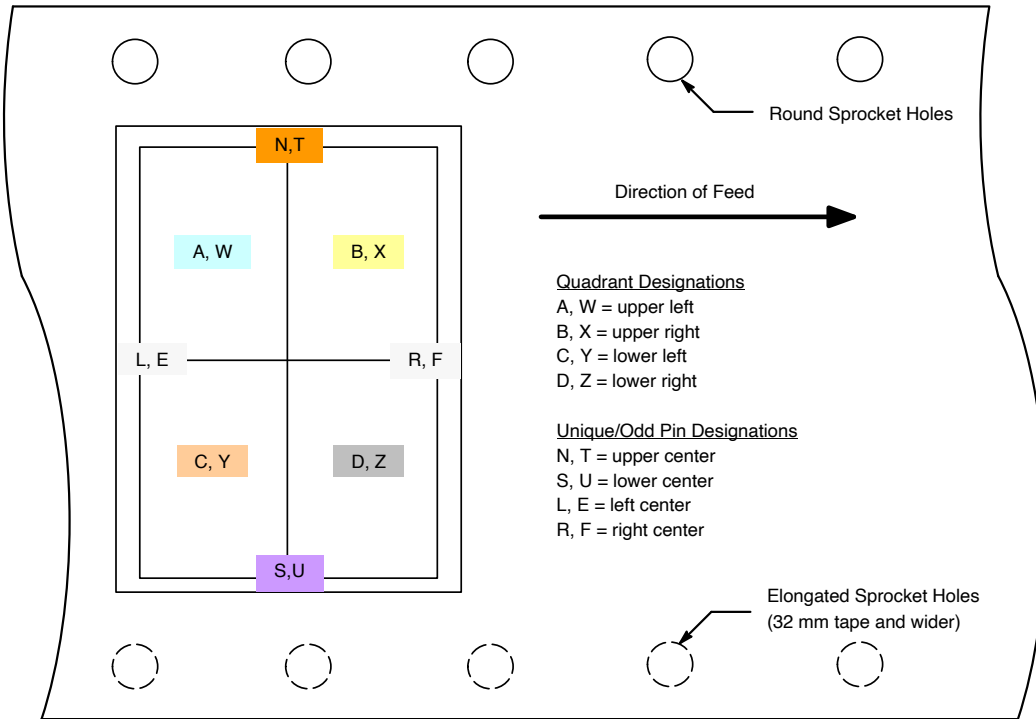

Leadless Package Pin 1 Orientation for Tape and Reel (Effective January 2007)

Part Number Suffix			Remark	Reel Size (mm) Diameter
Shipping Type*	Pin 1 Location	Blank or Pb-Free		
T	A	G	Quadrant 1 – Upper Left	178
T	B	G	Quadrant 2 – Upper Right	178
T	C	G	Quadrant 3 – Lower Left	178
T	D	G	Quadrant 4 – Lower Right	178
T	W	G	Quadrant 1 – Upper Left	330
T	X	G	Quadrant 2 – Upper Right	330
T	Y	G	Quadrant 3 – Lower Left	330
T	Z	G	Quadrant 4 – Lower Right	330
T	N	G	North (Upper Center)	178
T	S	G	South (Lower Center)	178
T	T	G	Top (Upper Center)	330
T	U	G	Under (Lower Center)	330
T	L	G	Left Center	178
T	R	G	Right Center	178
T	E	G	Left Center	330
T	F	G	Right Center	330

*T = Tape

BRD8011

Quadrant 1: Pin 1 is taped at Upper Left position

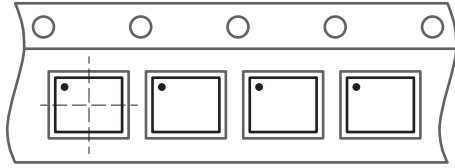

"TA" Pin 1 Tape Upper Left Position in 178 mm reel size.
"TW" Pin 1 Tape Upper Left Position in 330 mm reel size.

Quadrant 2: Pin 1 is taped at Upper Right position

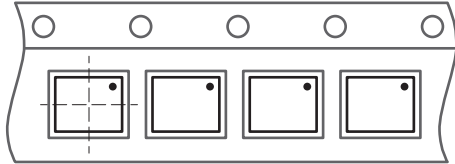

"TB" Pin 1 Tape Upper Right Position in 178 mm reel size.
"TX" Pin 1 Tape Upper Right Position in 330 mm reel size.

Quadrant 3: Pin 1 is taped at Lower Left position

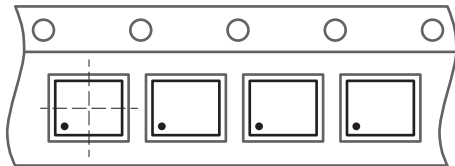

"TC" Pin 1 Tape Lower Left Position in 178 mm reel size.
"TY" Pin 1 Tape Lower Left Position in 330 mm reel size.

Quadrant 4: Pin 1 is taped at Lower Right position

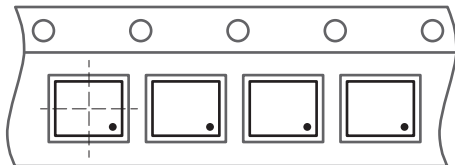

"TD" Pin 1 Tape Lower Right Position in 178 mm reel size.
"TZ" Pin 1 Tape Lower Right Position in 330 mm reel size.

If Pin #1 is located between two Quadrants, need to specify both Quadrants (e.g., Quadrant 1 & 2: Pin #1 is taped at Upper position).

BRD8011

Polarity mark is reference to EIA-481 between quadrant positions. There are 4 between quadrants position specified below.

Between Quadrant 1 & 2: Polarity Mark "TOP"

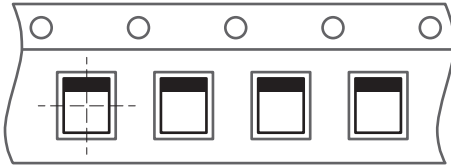

"TN" Polarity mark at "TOP" Position in 178 mm reel size.
"TT" Polarity mark at "TOP" Position in 330 mm reel size.

Between Quadrant 3 & 4: Polarity Mark "LOW" – EIA calls this "SOUTH" or "UNDER"

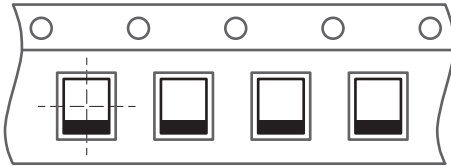

"TS" Polarity mark at "LOW" Position in 178 mm reel size.
"TU" Polarity mark at "LOW" Position in 330 mm reel size.

Between Quadrant 1 & 3: Polarity Mark "LEFT"

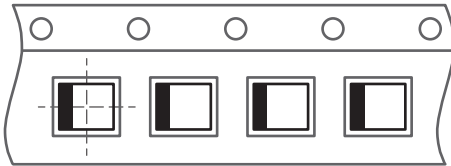

"TL" Polarity mark at "LEFT" Position in 178 mm reel size.
"TE" Polarity mark at "LEFT" Position in 330 mm reel size.

Between Quadrant 2 & 4: Polarity Mark "RIGHT"

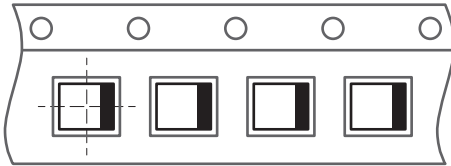

"TR" Polarity mark at "RIGHT" Position in 178 mm reel size.
"TF" Polarity mark at "RIGHT" Position in 330 mm reel size.

Package*	Pre Jan 2007	Post Jan 2007
DFN/QFN Square (LPCC)	T1	TB, TX
	T4	TB, TX
	R2	TB, TX
DFN/QFN Rectangular (LPCC)	T1	TA, TW
	R2	TA, TW
DFN/QFN	T2	TA, TW
	R2	TA, TW
FCBGA/BGA	R2	TA, TW
WLCSP	—	TR

* "W" suffix on any DFN/QFN package indicates the wettable flank option.

Reel Size

Reels are available in one piece, two piece, and three piece configurations. Unless specified, the configuration is based on local availability.

Make sure that the locking mechanism for two and three piece reels is fully engaged.

Reel Dimensions

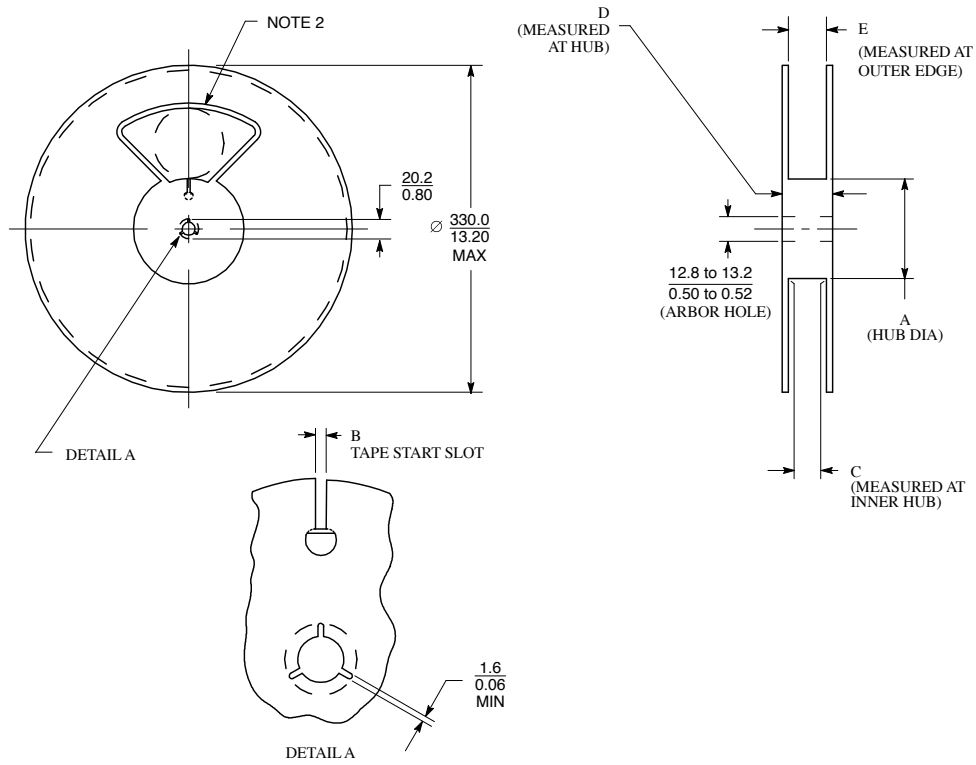

Reel Diameter	Tape Size	A mm (inches)		B mm (inches)		C mm (inches)		D (Max)	E (Max)
		Min	Max	Min	Max	Min	Max		
178.0 (7.01)	16.0 (0.63)		50.0 (1.97)	6.5 (0.26)	7.5 (0.30)	16.4 (0.65)	18.4 (0.72)	22.4 (18.4)	19.4 (0.76)
330.0 (12.99)	12.0 (0.47)	178.0 (7.01)		4.5 (0.18)	5.5 (0.22)	12.4 (0.49)	14.4 (0.57)	18.4 (0.72)	15.4 (0.61)
330.0 (12.99)	56.0 (2.20)	150.0 (5.91)		10.0 (0.39)	11.0 (0.43)	56.4 (2.22)	58.4 (2.30)	62.4 (2.46)	59.4 (2.34)
330.0 (12.99)	44.0 (1.73)	100.0 (3.94)		10.0 (0.39)	11.0 (0.43)	44.4 (1.75)	46.4 (1.83)	62.4 (2.46)	47.4 (1.87)
330.0 (12.99)	32.0 (1.26)	100.0 (3.94)		10.0 (0.39)	11.0 (0.43)	32.4 (1.28)	34.4 (1.35)	38.4 (1.51)	35.4 (1.39)
330.0 (12.99)	24.0 (0.94)	60.0 (2.36)		9.5 (0.37)	10.5 (0.41)	24.4 (0.96)	26.4 (1.04)	30.4 (1.51)	27.4 (1.08)
330.0 (12.99)	16.0 (0.63)			6.5 (0.26)	7.5 (0.30)	16.4 (0.65)	18.4 (0.72)	22.4 (0.88)	19.4 (0.76)
330.0 (12.99)	12.0 (0.47)			4.5 (0.18)	5.5 (0.22)	12.4 (0.49)	14.4 (0.57)	18.4 (0.72)	15.4 (0.61)
330.0 (12.99)	8.0 (0.31)	50.0 (1.97)		2.5 (0.10)	3.5 (0.14)	8.4 (0.33)	9.9 (0.39)	14.4 (0.57)	10.9 (0.43)
178.0 (7.01)	12.0 (0.47)	50.0 (1.97)		4.5 (0.18)	5.5 (0.22)	12.4 (0.49)	14.4 (0.57)	18.4 (0.72)	15.4 (0.61)
178.0 (7.00)	8.0 (0.31)	50.0 (1.97)		2.5 (0.10)	3.5 (0.14)	8.4 (0.33)	9.9 (0.39)	14.4 (0.57)	10.9 (0.43)
330.0 (12.99)	8.0 (0.31)	50.0 (1.97)		4.0 (0.16)	5.0 (0.20)	8.4 (0.33)	9.9 (0.39)	14.4 (0.57)	10.9 (0.43)
178.0 (7.00)	8.0 (0.31)	50.0 (1.97)		4.0 (0.16)	5.0 (0.20)	8.4 (0.33)	9.9 (0.39)	14.4 (0.57)	10.9 (0.43)

BRD8011

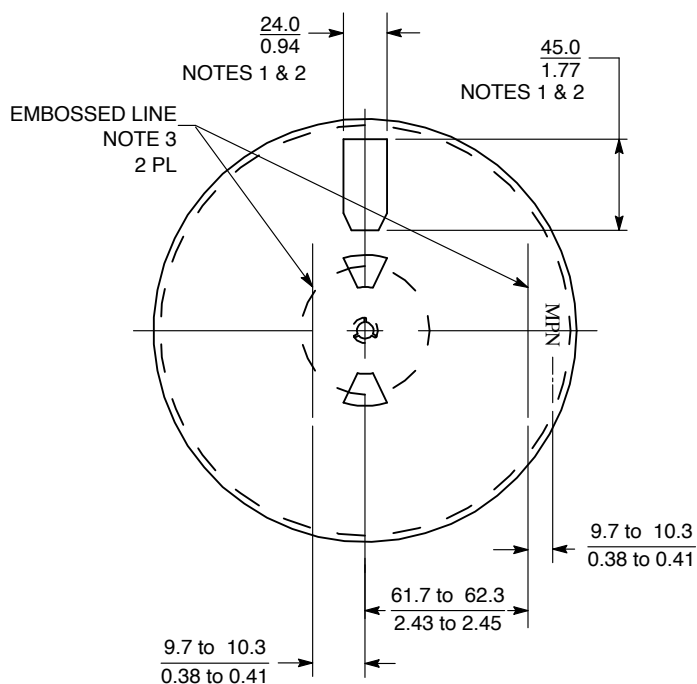

Front View of 178 mm (7.0 in) Reel

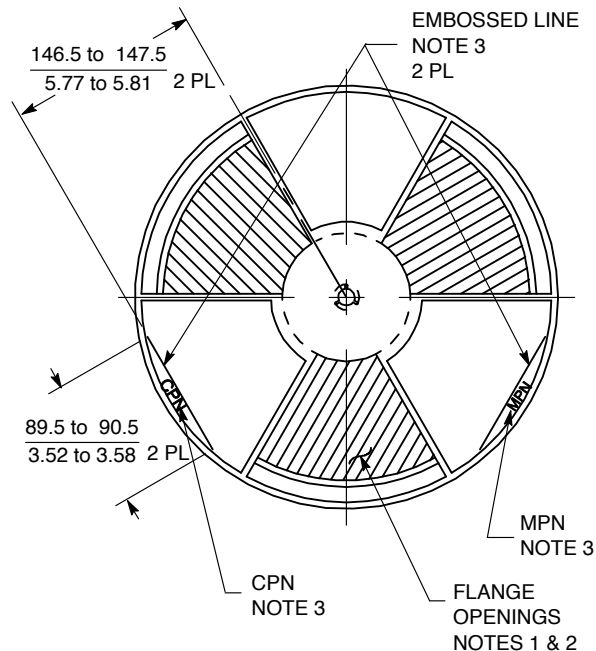

Front View of 330 mm (13.0 in) Reel

Notes:

1. LABEL PLACEMENT AREA:

- All reels must have flat area on the front flange of the reel that will fit two 41.3 mm (1.65 in) by 125 mm (4.90 in) **onsemi** barcode labels.
- If there are any flange openings on the front side of the 178 mm (7.00 in) reel they must be designed in locations so that two of the 41.3 mm (1.65 in) **onsemi** barcode labels can be applied parallel to each other as in Figure A.
- If there are any flange openings on the front flange of the 330 mm (13.0 in) reel they must be designed in locations so that two of the 41.3 mm (1.65 in) by 125 mm (4.90 in) onsemi barcode labels can be applied parallel to each other as in Figure B.

2. FLANGE OPENINGS

- Flange opening on the front and the back of the reel are a supplier option but must meet all of the requirements in Note 1. The preferred size for the 176 mm (7.0 in) reel is shown in the figure above.
- The tape loading opening must be as in Detail A.

3. GRAPHICS

- The letters MPN and CPN are an option. The size and thickness of the letters are the manufacturer's option and are not to be used for inspection criteria.
- The embossed lines on the reel are an option. If the lines are used they must be located as in the figures above. They must be a minimum 38 mm (1.50 in) long. The thickness is a manufacturer's option and not to be used for inspection criteria.

Reel Labeling

Place the reel on an ESD protective surface so that the round sprocket holes are on the bottom. The direction of travel when unwound should be from the top right quadrant. See illustration below.

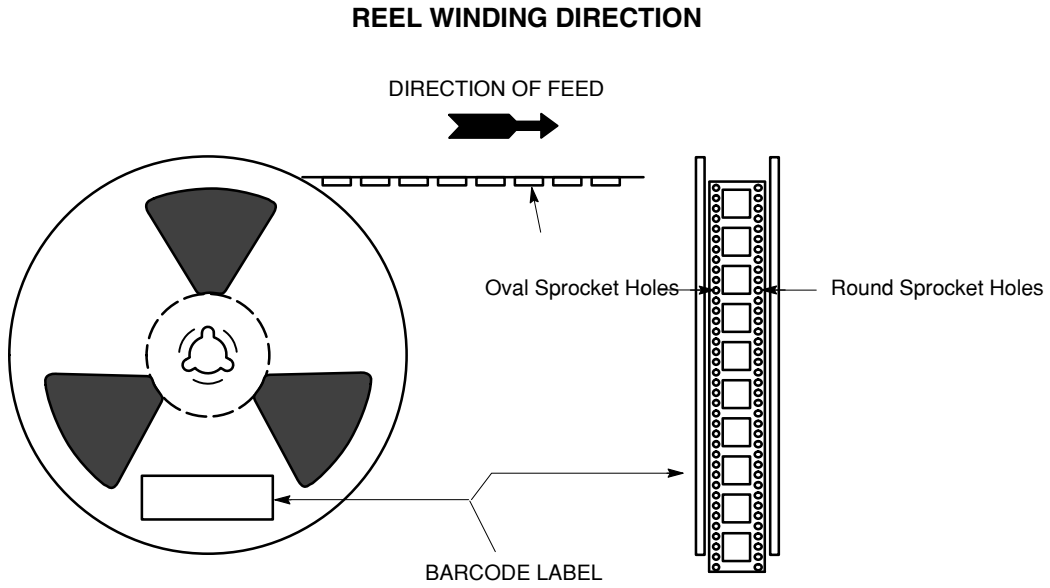

**Round and Oval Sprocket Holes Used with 32 mm, 42 mm, 44 mm and 52 mm Tape
(holes on both sides)**

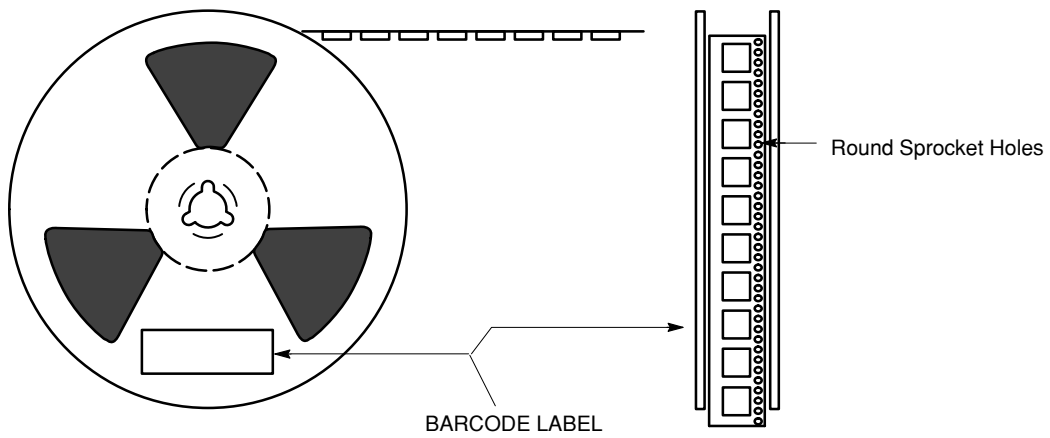

**Round Sprocket Holes Used with 8 mm, 12 mm, 16 mm and 24 mm Tape
(holes on one side only)**

BRD8011

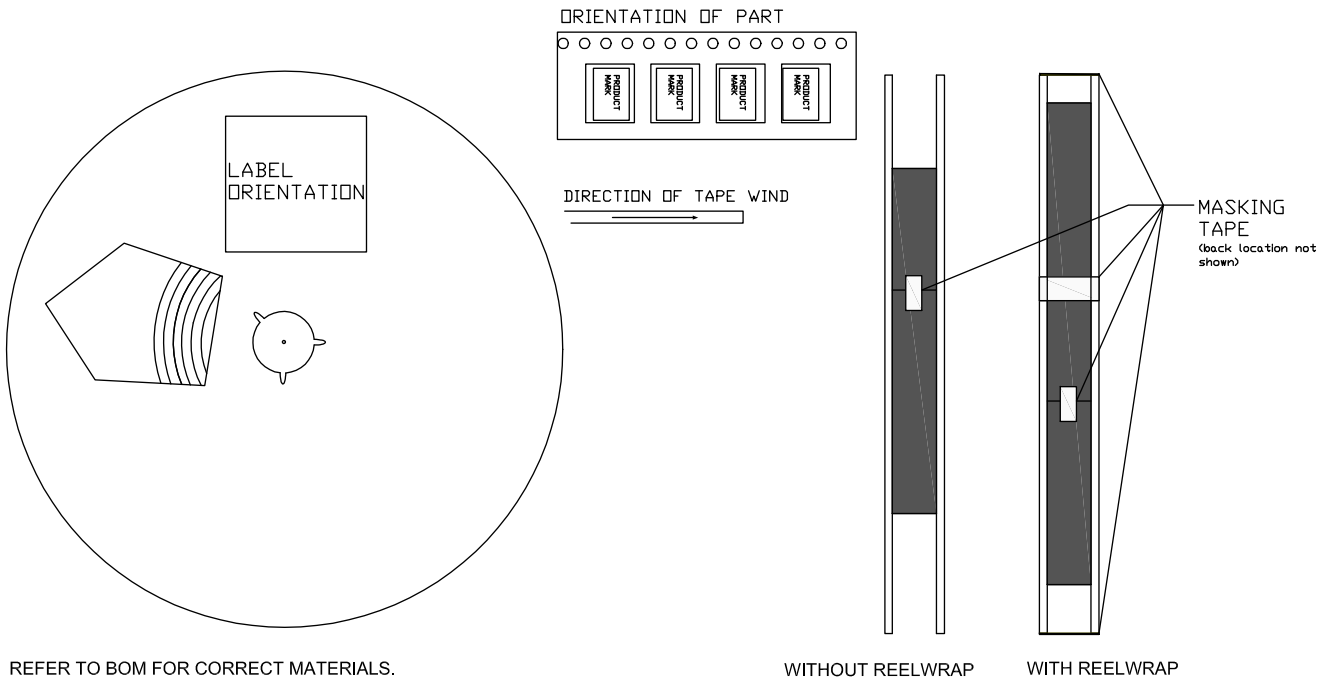

REFER TO BOM FOR CORRECT MATERIALS.

- MASKING TAPE APPLIED IN 6 LOCATIONS:
- 1) SECURE CARRIER TAPE
 - 2) SECURE REELWRAP
 - 3-6) 4 LOCATIONS AROUND REEL TO FURTHER SECURE REELWRAP

Seal Procedure

Taping equipment with vision.

- Verify that the product lighting system is operating properly.
- Verify that the correct program is available and that it is functioning properly.

Material and set-up verification

- Verify that the product identification matches the accompanying documentation.
- Verify that the proper embossed tape is mounted on the equipment.
- Verify that the proper shipping reel is on the take up sprocket.
- Verify that the proper process parameter settings are used for the specific equipment.
- Verify that the equipment parameter settings are within the range defined in the appropriate table.

Sealing Parameters:

- Sealing parameters are based on the material and machine qualification result. These parameters should be correct prior machine operation.

Leader and Trailer:

- The TRAILER is the part of the tape that is near the hub of the plastic reel. TRAILER should have a minimum of 160mm in length and it consists of empty cavities with sealed cover tape.
- The LEADER is the part of the tape that is at the outer part of the plastic reel. LEADER should have a minimum of 400mm in length and it consists of empty cavities with sealed cover tape.

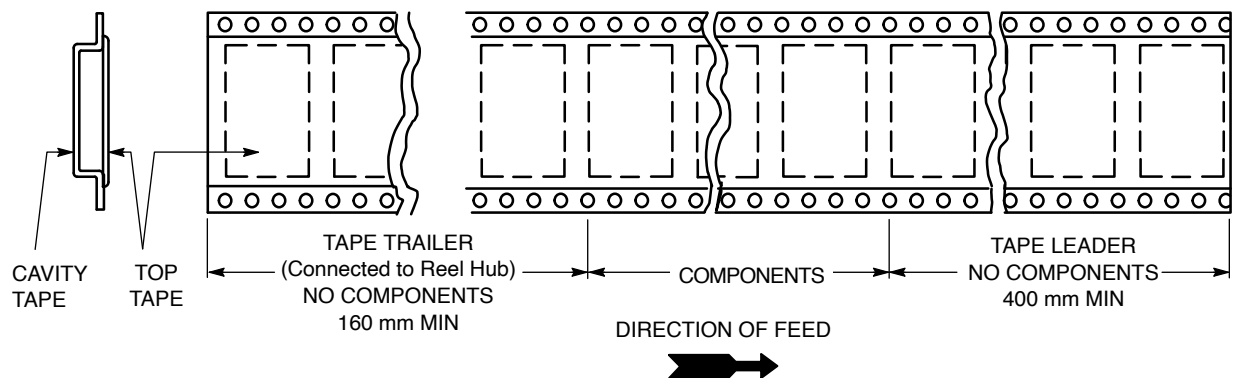
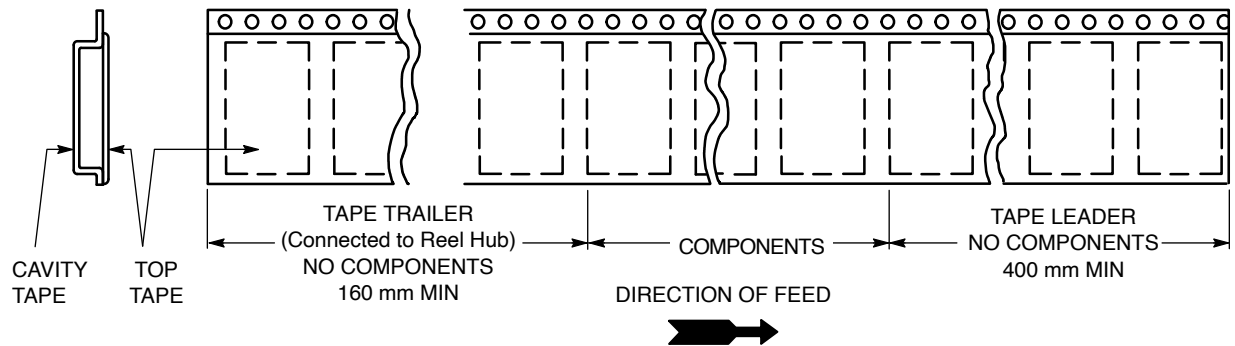

Embossed Carrier Tape Dimension and Specification

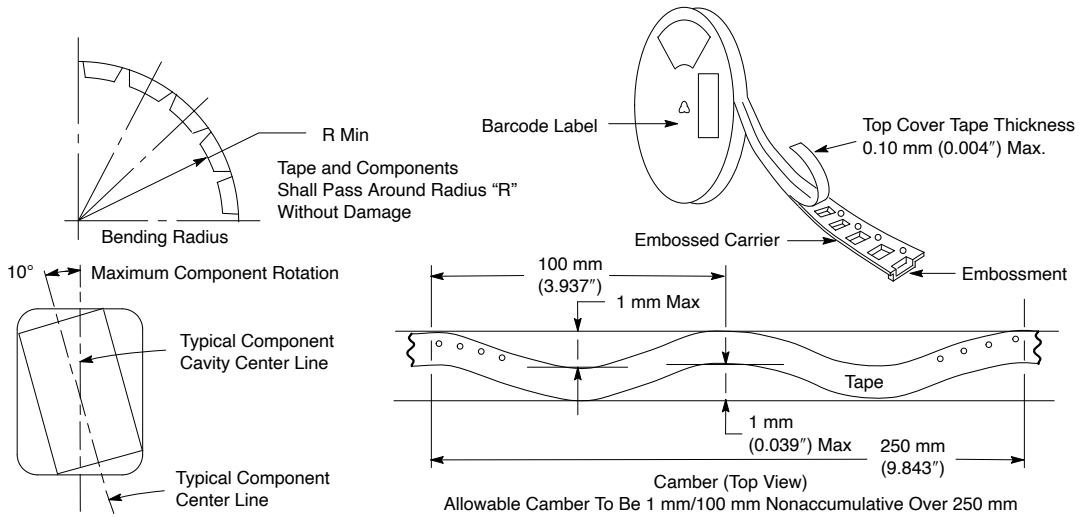
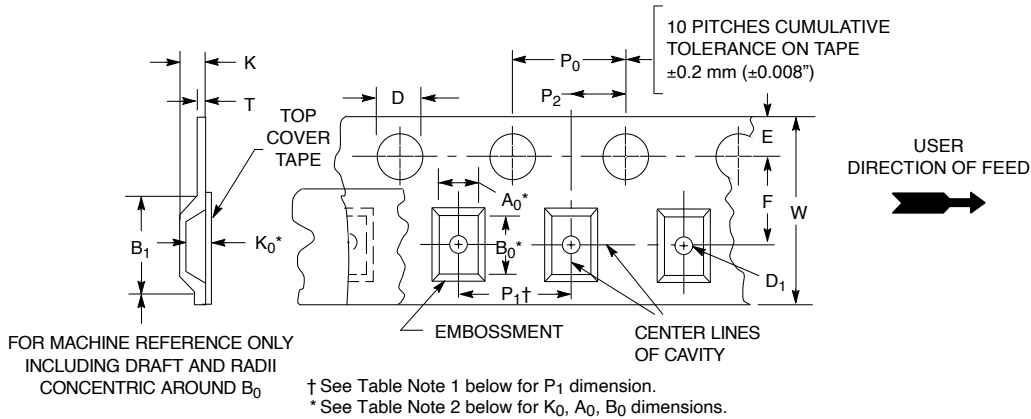

DIMENSIONS

Tape Size (W)	B ₁ Max (Note 1)	D	D ₁	E	F	K	P ₀	P ₂	R Min	T Max	W Max
8 mm	4.55 mm (0.179")	1.5 + 0.1 mm (0.059 + 0.004" -0.0)	1.0 Min (0.039") or 0.5 mm Min (0.020")	1.75 ±0.1 mm (0.069 ±0.004")	3.5 ±0.05 mm (0.138 ±0.002")	2.4 mm Max (0.094")	4.0 ±0.1 mm (0.157 ±0.004")	1	25 mm (0.98")	0.6 mm (0.024")	8.3 mm (0.327")
12 mm	8.2 mm (0.323")				5.5 ±0.05 mm (0.217 ±0.002")	6.4 mm Max (0.252")				0.3 mm (0.012") for POWERMITE	
16 mm	12.1 mm (0.476")				7.5 ±0.10 mm (0.295 ±0.004")	7.9 mm Max (0.311")				0.254 mm (0.01") for SOD123FL	
24 mm	20.1 mm (0.791")				11.5 ±0.10 mm (0.453 ±0.004")	11.9 mm Max (0.468")				24.3 mm (0.957")	

1. Metric dimensions govern – English are in parentheses for reference only.
2. Pitch information (dimension P₁) is contained in Embossed Tape and Reel Listing.
3. A₀, B₀, and K₀ are determined by component size. The clearance between the components and the cavity must be within 0.05 mm min to 0.50 mm max. The component cannot rotate more than 10° within the determined cavity.

Reel Orientation for LGA, SiP Packages

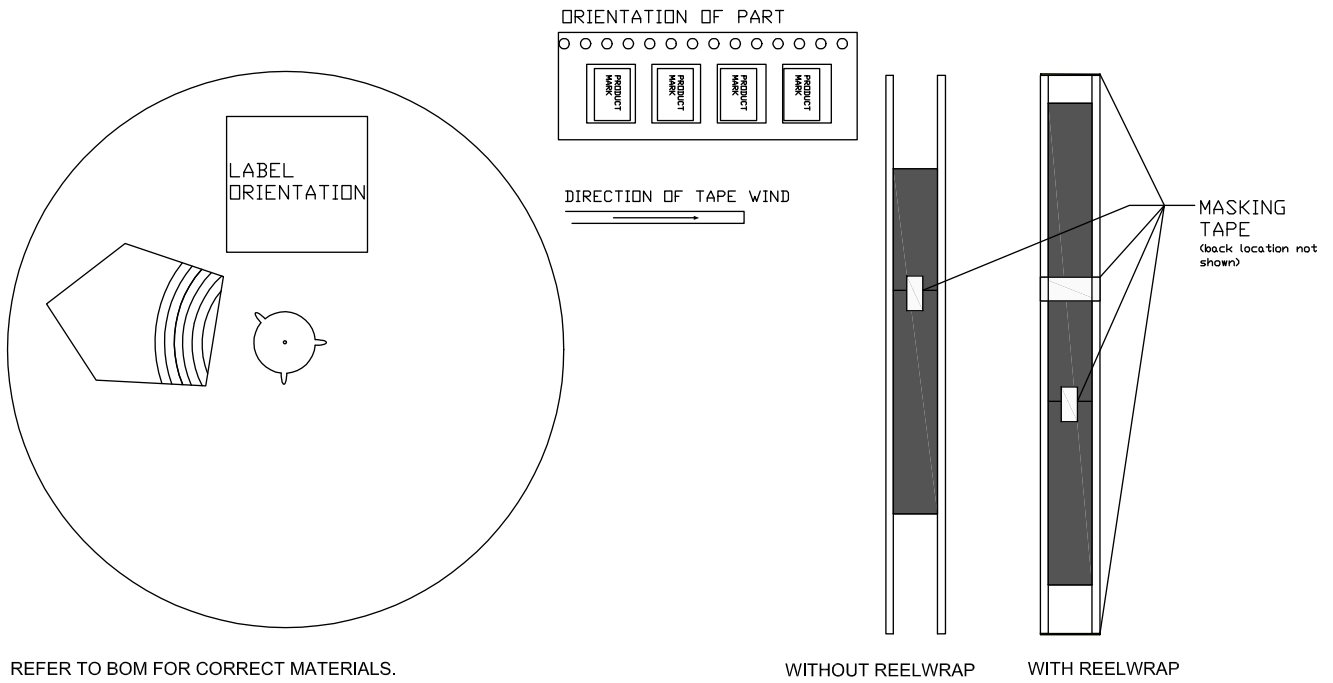

REFER TO BOM FOR CORRECT MATERIALS.

- MASKING TAPE APPLIED IN 6 LOCATIONS:
- 1) SECURE CARRIER TAPE
 - 2) SECURE REELWRAP
 - 3-6) 4 LOCATIONS AROUND REEL TO FURTHER SECURE REELWRAP

TO-92 EIA, IEC, EIAJ Radial Tape in Fan Fold Box or On Reel

Radial tape in fan fold box or on reel of the reliable TO-92 package are the best methods of capturing devices for automatic insertion in printed circuit boards. These methods of taping are compatible with various equipment for active and passive component insertion.

- Available in Fan Fold Box
- Available on 365 mm Reels
- Accommodates All Standard Inserters
- Allows Flexible Circuit Board Layout
- 2.5 mm Pin Spacing for Soldering
- EIA-468, IEC 286-2, EIAJ RC1008B

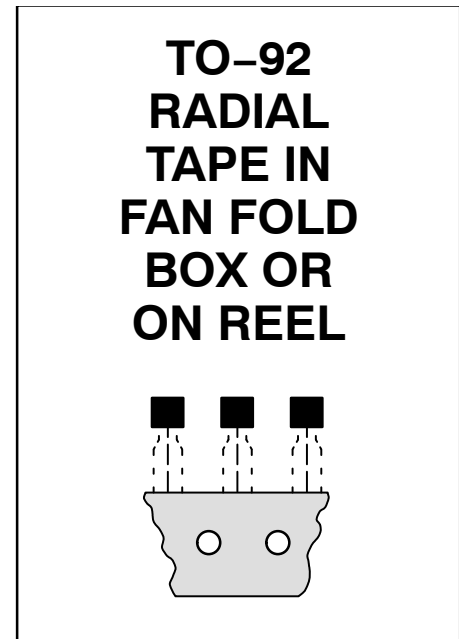

Ordering Notes:

When ordering radial tape in fan fold box or on reel, specify the style per Figures 54, 55, 61 and 62. Add the suffix “RLR” and “Style” to the device title, i.e. 2N5060RLRA. This will be a standard 2N5060 radial taped and supplied on a reel. Some products only utilize the last 2 digits. Please refer to the **onsemi** device data sheet for exact ordering information.

- Fan Fold Box Information – Minimum order quantity 1 Box. Order in increments of 2000.
- Reel Information – Minimum order quantity 1 Reel. Order in increments of 2000.

US/EUROPEAN SUFFIX CONVERSIONS

U.S.	Europe	Package Style
RLRA, RA	RL	Reel
RLRE, RE	RL1	Reel
RLRM, RM	ZL1	Fan Fold
RLRP, RP	-	Fan Fold

TO-92 EIA RADIAL TAPE IN FAN FOLD BOX OR ON REEL

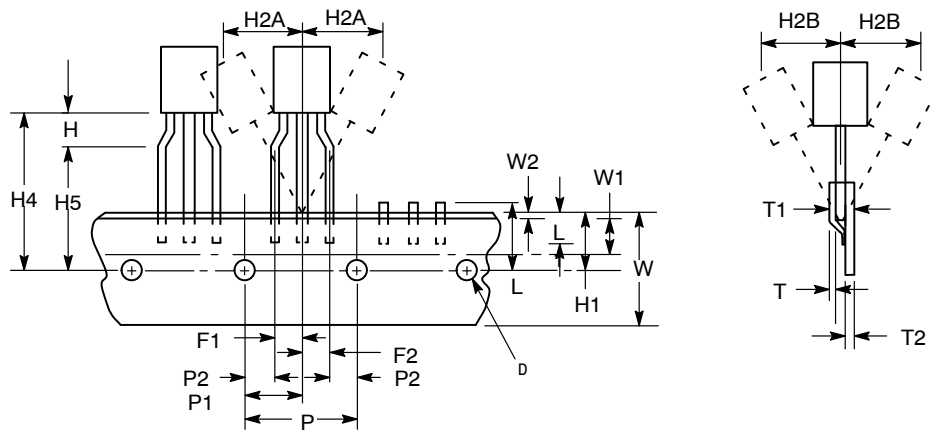

Figure 53. Device Positioning on Tape

Symbol	Item	Specification			
		Inches		Millimeter	
		Min	Max	Min	Max
D	Tape Feedhole Diameter	0.1496	0.1653	3.8	4.2
D2	Component Lead Thickness Dimension	0.015	0.020	0.38	0.51
F1, F2	Component Lead Pitch	0.0945	0.110	2.4	2.8
H	Bottom of Component to Seating Plane	0.059	0.156	1.5	4.0
H1	Feedhole Location	0.3346	0.3741	8.5	9.5
H2A	Deflection Left or Right	0	0.039	0	1.0
H2B	Deflection Front or Rear	0	0.051	0	1.0
H4	Feedhole to Bottom of Component	0.7086	0.768	18	19.5
H5	Feedhole to Seating Plane	0.610	0.649	15.5	16.5
L	Defective Unit Clipped Dimension	0.3346	0.433	8.5	11
L1	Lead Wire Enclosure	0.09842	–	2.5	–
P	Feedhole Pitch	0.4921	0.5079	12.5	12.9
P1	Feedhole Center to Center Lead	0.2342	0.2658	5.95	6.75
P2	First Lead Spacing Dimension	0.1397	0.1556	3.55	3.95
T	Adhesive Tape Thickness	0.06	0.08	0.15	0.20
T1	Overall Taped Package Thickness	–	0.0567	–	1.44
T2	Carrier Strip Thickness	0.014	0.027	0.35	0.65
W	Carrier Strip Width	0.6889	0.7481	17.5	19
W1	Adhesive Tape Width	0.2165	0.2841	5.5	6.3
W2	Adhesive Tape Position	0.0059	0.01968	0.15	0.5

3. Maximum alignment deviation between leads not to be greater than 0.2 mm.
4. Defective components shall be clipped from the carrier tape such that the remaining protrusion (L) does not exceed a maximum of 11 mm.
5. Component lead to tape adhesion must meet the pull test requirements established in Figures 57, 58 and 59.
6. Maximum non-cumulative variation between tape feed holes shall not exceed 1 mm in 20 pitches.
7. Hold down tape not to extend beyond the edge(s) of carrier tape and there shall be no exposure of adhesive.
8. No more than 1 consecutive missing component is permitted.
9. A tape trailer and leader, having at least three feed holes is required before the first and after the last component.
10. Splices will not interfere with the sprocket feed holes.

TO-92 EIA RADIAL TAPE IN FAN FOLD BOX OR ON REEL

FAN FOLD BOX STYLES

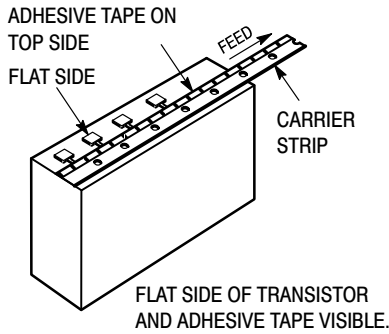

Style M fan fold box is equivalent to styles E and F of reel pack dependent on feed orientation from box.

Figure 54. Style RLRM, RM

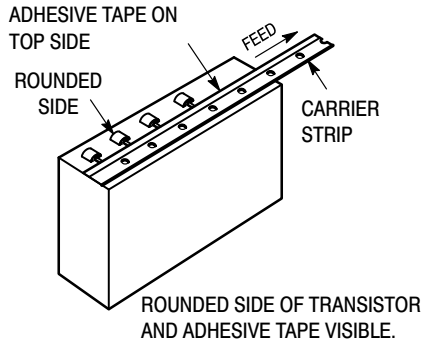

Style P fan fold box is equivalent to styles A and B of reel pack dependent on feed orientation from box.

Figure 55. Style RLRP, RP

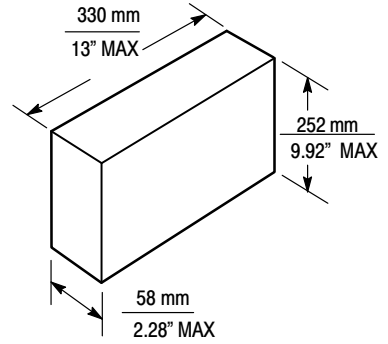
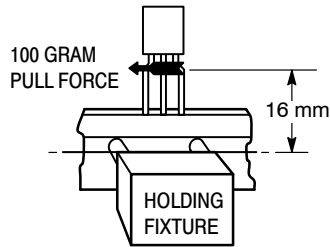

Figure 56. Fan Fold Box Dimensions

ADHESION PULL TESTS



The component shall not pull free with a 300 gram load applied to the leads for 3 ± 1 second.

Figure 57. Test #1

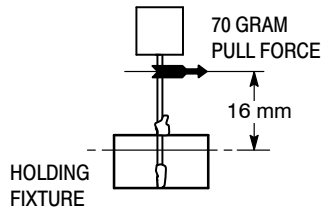

The component shall not pull free with a 70 gram load applied to the leads for 3 ± 1 second.

Figure 58. Test #2

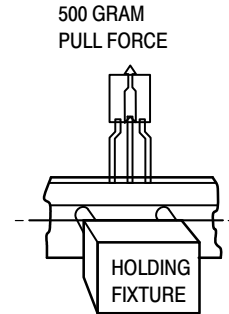

There shall be no deviation in the leads and no component leads shall be pulled free of the tape with a 500 gram load applied to the component body for 3 ± 1 second.

Figure 59. Test #3

TO-92 EIA RADIAL TAPE IN FAN FOLD BOX OR ON REEL: REEL STYLES

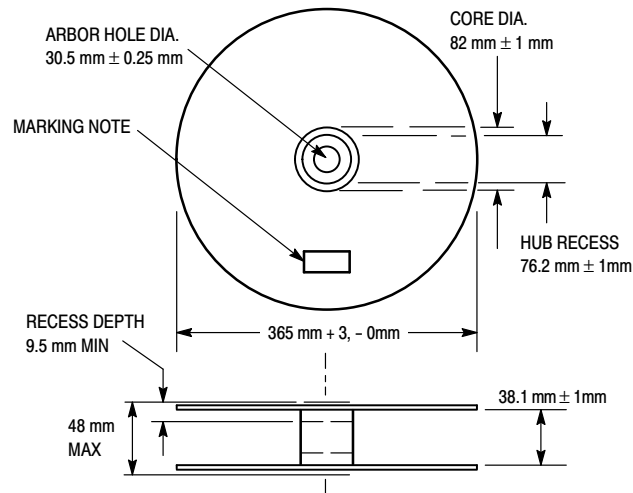

Material used must not cause deterioration of components or degrade lead solderability

Figure 60. Reel Specifications

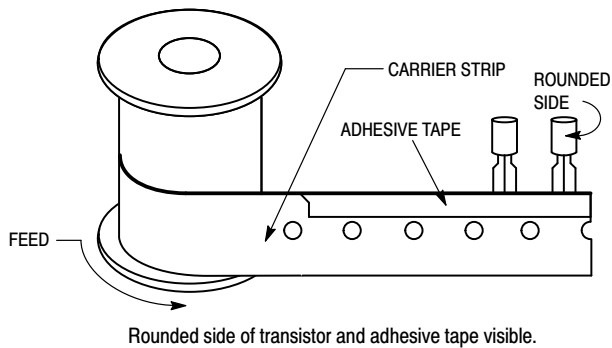

Figure 61. Style RLRA, RA

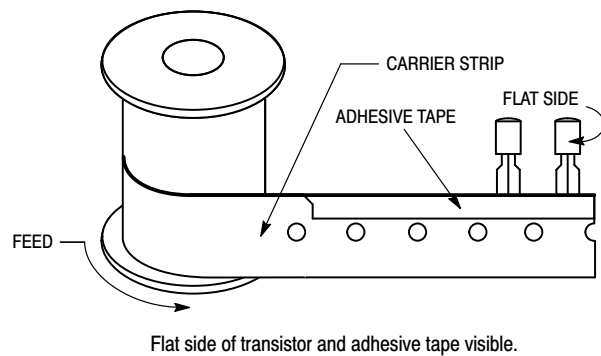

Figure 62. Style RLRE, RE

Lead Tape Packaging Standards for Axial-Lead Components

1.0 SCOPE

This section covers packaging requirements for the following axial-lead component's use in automatic testing and assembly equipment: **onsemi** Case 17-02, Case 41A-02, Case 51-02 (DO-7), Case 59-03 (DO-41), Case 59-04, Case 194-04 and Case 299-02 (DO-35). Packaging, as covered in this section, shall consist of axial-lead components mounted by their leads on pressure sensitive tape, wound onto a reel.

2.0 PURPOSE

This section establishes **onsemi** standard practices for lead-tape packaging of axial-lead components and meets the requirements of EIA Standard RS-296-D "Lead-taping of Components on Axial Lead Configuration for Automatic Insertion," level 1.

3.0 REQUIREMENTS

3.1 Component Leads

3.1.1 – Component leads shall not be bent beyond dimension E from their normal position. See Figure 64.

3.1.2 – The "C" dimension shall be governed by the overall length of the reel packaged component. The distance between flanges shall be 0.059 inch to 0.315 inch greater than the overall component length. See Figures 64 and 65.

3.1.3 – Cumulative dimension "A" tolerance shall not exceed 0.059 over 6 in consecutive components.

3.2 Orientation

All polarized components must be oriented in one direction. The cathode lead tape shall be any color except white and the anode tape shall be white. See Figure 63.

3.3 Reeling

3.3.1 – Components on any reel shall not represent more than two date codes when date code identification is required.

3.3.2 – Component's leads shall be positioned perpendicularly between pairs of 0.250 inch tape. See Figure 64.

3.3.3 – A minimum 12 inch leader of tape shall be provided before the first and last component on the reel.

3.3.4 – 50 lb. Kraft paper is wound between layers of components as far as necessary for component protection.

3.3.5 – Components shall be centered between tapes such that the difference between D1 and D2 does not exceed 0.055.

3.3.6 – Staples shall not be used for splicing. No more than four layers of tape shall be used in any splice area and no tape shall be offset from another by more than 0.031 inch noncumulative. Tape splices shall overlap at least 6 inches for butt joints and at least 3 inches for lap joints and shall not be weaker than unspliced tape.

3.3.7 – Quantity per reel shall be as indicated in Table 1. Orders for tape and reeled product will only be processed and shipped in full reel increments. Scheduled orders must be in releases of full reel increments or multiples thereof.

3.3.8 – A maximum of 0.25% of the components per reel quantity may be missing without consecutive missing per level 1 of RS-296-D.

3.3.9 – The single face roll pad shall be placed around the finished reel and taped securely. Each reel shall then be placed in an appropriate container.

3.4 Marking

Minimum reel and carton marking shall consist of the following (see Figure 65):

onsemi part number

Quantity

Manufacturer's name

Date codes (when applicable; see note **3.3.1**)

4.0

Requirements differing from this **onsemi** standard shall be negotiated with the factory.

The packages indicated in the following table are suitable for lead tape packaging. Table 1 indicates the specific devices (transient voltage suppressors and/or Zeners) that can be obtained from **onsemi** in reel packaging and provides the appropriate packaging specification.

Lead Tape Packaging Standards for Axial-Lead Components

Table 1. PACKAGING DETAILS (all dimensions in inches)

Case Type	Product Category	Device Title Suffix	MPQ Quantity Per Reel	Component Spacing A Dimension	Tape Spacing B Dimension	Reel Dimension C	Reel Dimension D (Max)	Max Off Alignment E
Case 17	Surmetic 40 & 600 Watt TVS	RL	4000	0.2 ± 0.015	2.062 ± 0.059	3	14	0.047
Case 41A	1500 Watt TVS	RL4	1500	0.4 ± 0.02	2.062 ± 0.059	3	14	0.047
Case 59	DO-41 Glass & DO-41 Surmetic 30	RL	6000	0.2 ± 0.015	2.062 ± 0.059	3	14	0.047
	Rectifier							
Case 59	500 Watt TVS	RL	500	0.2 ± 0.02	2.062 ± 0.059	3	14	0.047
	Rectifier							
Case 194	110 Amp TVS (Automotive)	RL	800	0.4 ± 0.02	1.875 ± 0.059	3	14	0.047
	Rectifier							
Case 267	Rectifier	RL	1500	0.4 ± 0.02	2.062 ± 0.059	3	14	0.047
Case 299	DO-35 Glass	RL	5000	0.2 ± 0.02	2.062 ± 0.059	3	14	0.047
Case 267	Schottky & Ultrafast Rectifiers	RL	1500	0.4 ± 0.02	2.062 ± 0.059	3	14	0.047
Case 267	Fast Recovery & General Purpose Rectifiers	RL	1200	0.4 ± 0.02	2.062 ± 0.059	3	14	0.047

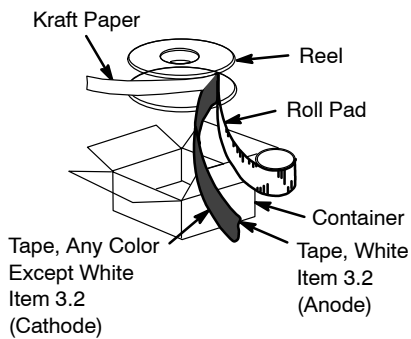

Figure 63. Reel Packing

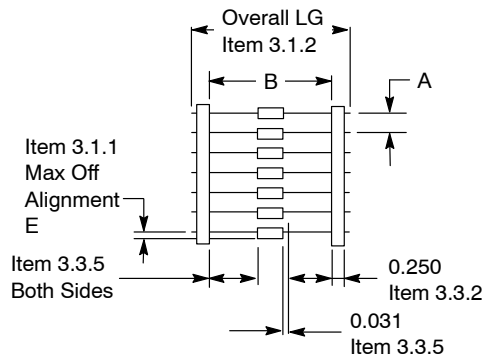

Figure 64. Component Spacing

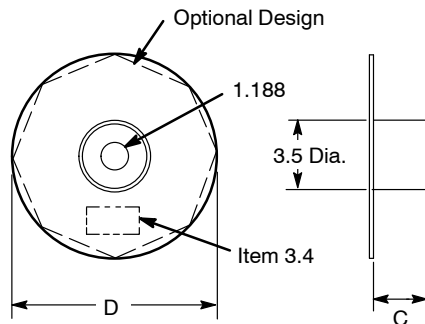

Figure 65. Reel Dimensions (Item references appear on Page 39)

INFORMATION FOR USING SURFACE MOUNT PACKAGES

RECOMMENDED FOOTPRINTS FOR SURFACE MOUNTED APPLICATIONS

Surface mount board layout is a critical portion of the total design. The footprint for the semiconductor packages must be the correct size to ensure proper solder connection

interface between the board and the package. With the correct pad geometry, the packages will self align when subjected to a solder reflow process.

POWER DISSIPATION FOR A SURFACE MOUNT DEVICE

The power dissipation for a surface mount device is a function of the drain/collector pad size. These can vary from the minimum pad size for soldering to a pad size given for maximum power dissipation. Power dissipation for a surface mount device is determined by $T_{J(max)}$, the maximum rated junction temperature of the die, $R_{\theta JA}$, the thermal resistance from the device junction to ambient, and the operating ambient temperature, T_A . Using the values provided on the data sheet, P_D can be calculated as follows:

$$P_D = \frac{T_{J(max)} - T_A}{R_{\theta JA}}$$

The values for the equation are found in the maximum ratings table on the data sheet. Substituting these values into the equation for an ambient temperature T_A of 25°C, one can calculate the power dissipation of the device. For example, for a SOT-223 device, P_D is calculated as follows.

$$P_D = \frac{150^\circ\text{C} - 25^\circ\text{C}}{156^\circ\text{C/W}} = 800 \text{ milliwatts}$$

The 156°C/W for the SOT-223 package assumes the use of the recommended footprint on a glass epoxy printed circuit board to achieve a power dissipation of 800 milliwatts. There are other alternatives to achieving higher power dissipation from the surface mount packages. One is to increase the area of the drain/collector pad. By increasing the area of the drain/collector pad, the power dissipation can be increased. Although the power dissipation can almost be doubled with this method, area is taken up on the printed circuit board which can defeat the purpose of using surface mount technology. For example, a graph of $R_{\theta JA}$ versus drain pad area is shown in Figures 66, 67 and 68.

Another alternative would be to use a ceramic substrate or an aluminum core board such as Thermal Clad™. Using a board material such as Thermal Clad, an aluminum core board, the power dissipation can be doubled using the same footprint.

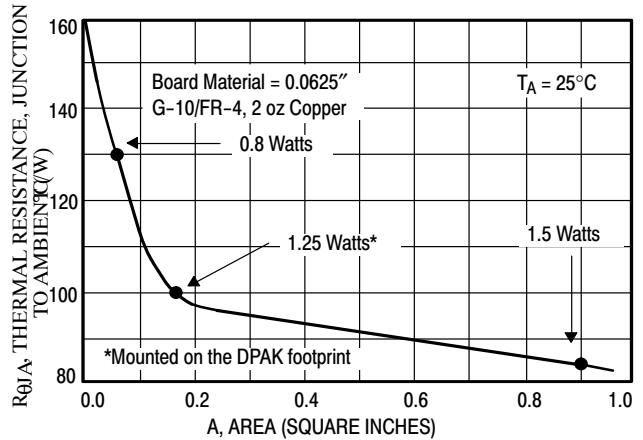

Figure 66. Thermal Resistance versus Drain Pad Area for the SOT-223 Package (Typical)

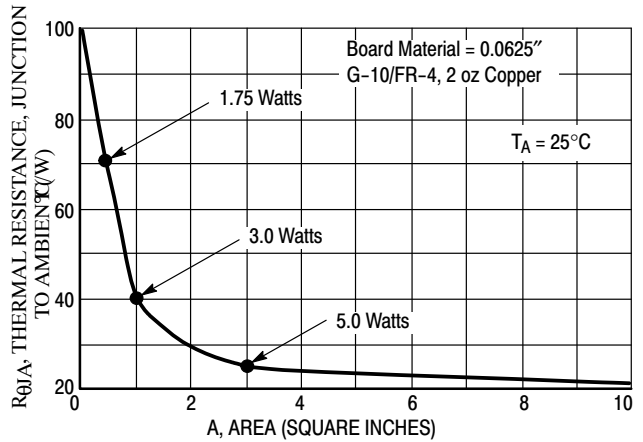

Figure 67. Thermal Resistance versus Drain Pad Area for the DPAK Package (Typical)

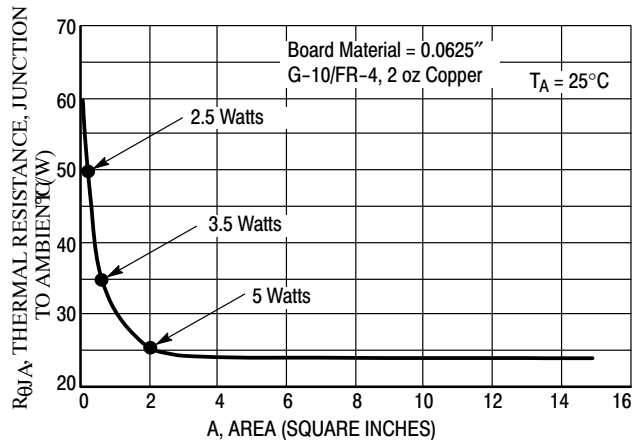

Figure 68. Thermal Resistance versus Drain Pad Area for the D²PAK Package (Typical)

SOLDER STENCIL GUIDELINES

Prior to placing surface mount components onto a printed circuit board, solder paste must be applied to the pads. Solder stencils are used to screen the optimum amount. These stencils are typically 0.008 inches thick and may be made of brass or stainless steel. For packages such as the SC-59, SC-70/SOT-323, SOD-123, SOT-23, SOT-143, SOT-223, SO-8, SO-14, SO-16, and SMB/SMC diode packages, the stencil opening should be the same as the pad size or a 1:1 registration. This is not the case with the DPAK and D²PAK packages. If a 1:1 opening is used to screen solder onto the drain pad, misalignment and/or “tombstoning” may occur due to an excess of solder. For these two packages, the opening in the stencil for the paste should be approximately 50% of the tab area. The opening for the leads is still a 1:1 registration. Figure 69 shows a typical stencil for the DPAK and D²PAK packages. The

pattern of the opening in the stencil for the drain pad is not critical as long as it allows approximately 50% of the pad to be covered with paste.

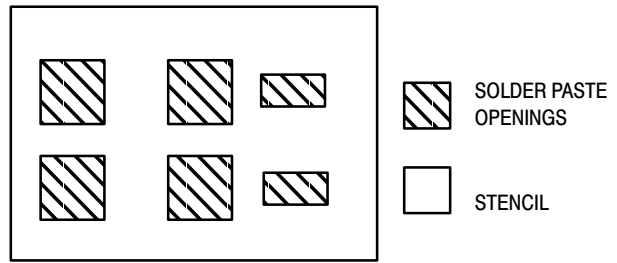

Figure 69. Typical Stencil for DPAK and D²PAK Packages

SOLDERING PRECAUTIONS

The melting temperature of solder is higher than the rated temperature of the device. When the entire device is heated to a high temperature, failure to complete soldering within a short time could result in device failure. Therefore, the following items should always be observed in order to minimize the thermal stress to which the devices are subjected.

- Always preheat the device.
- The delta temperature between the preheat and soldering should be 100°C or less.*
- When preheating and soldering, the temperature of the leads and the case must not exceed the maximum temperature ratings as shown on the data sheet. When using infrared heating with the reflow soldering method, the difference should be a maximum of 10°C.
- For wave soldering, the soldering temperature and time should not exceed 260°C for more than 10 seconds. For other reflow methods such as convection and IR ovens, refer to the reflow profiles on the following pages.

- When shifting from preheating to soldering, the maximum temperature gradient shall be 5°C or less.
- After soldering has been completed, the device should be allowed to cool naturally for at least three minutes. Gradual cooling should be used since the use of forced cooling will increase the temperature gradient and will result in latent failure due to mechanical stress.
- Mechanical stress or shock should not be applied during cooling.

* Soldering a device without preheating can cause excessive thermal shock and stress which can result in damage to the device.

* Due to shadowing and the inability to set the wave height to incorporate other surface mount components, the D²PAK is not recommended for wave soldering.

TYPICAL SOLDER HEATING PROFILE

For any given circuit board, there will be a group of control settings that will give the desired heat pattern. The operator must set temperatures for several heating zones and a figure for belt speed. Taken together, these control settings make up a heating “profile” for that particular circuit board. On machines controlled by a computer, the computer remembers these profiles from one operating session to the next. Figure 70 shows a typical heating profile for use when soldering a surface mount device to a printed circuit board. This profile will vary among soldering systems, but it is a good starting point. Factors that can affect the profile include the type of soldering system in use, density and types of components on the board, type of solder used, and the type of board or substrate material being used. This profile shows temperature versus time. The line on the graph shows the

actual temperature that might be experienced on the surface of a test board at or near a central solder joint. The two profiles are based on a high density and a low density board. The Vitronics SMD310 convection/infrared reflow soldering system was used to generate this profile. The type of solder used was 62/36/2 Tin Lead Silver with a melting point between 177–189°C. When this type of furnace is used for solder reflow work, the circuit boards and solder joints tend to heat first. The components on the board are then heated by conduction. The circuit board, because it has a large surface area, absorbs the thermal energy more efficiently, then distributes this energy to the components. Because of this effect, the main body of a component may be up to 30 degrees cooler than the adjacent solder joints.

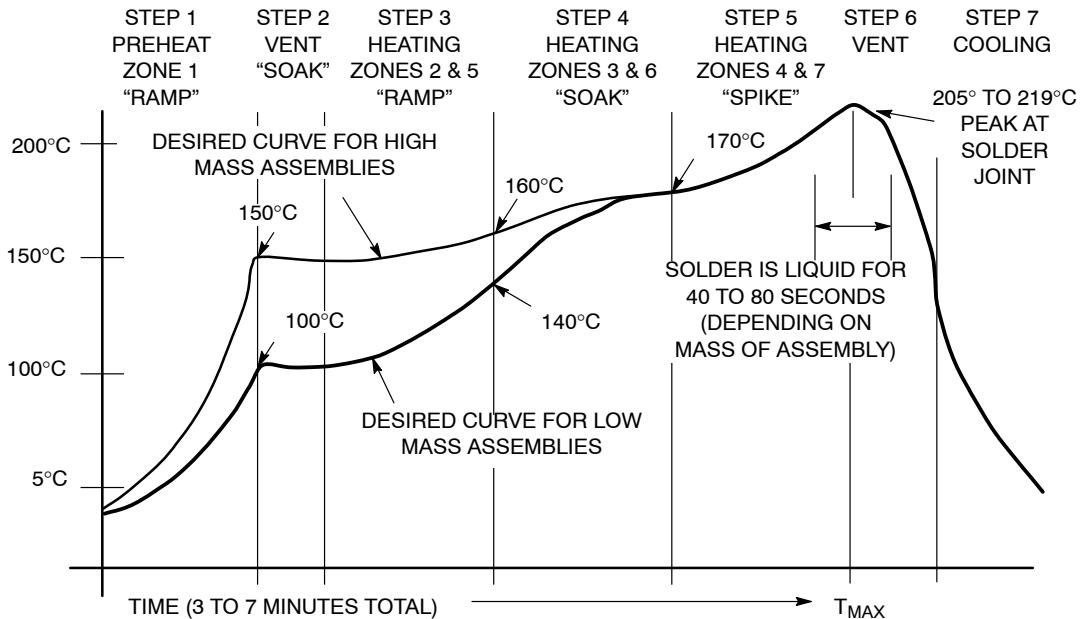

Figure 70. Typical Tin Lead (SnPb) Solder Heating Profile

TYPICAL SOLDER HEATING PROFILE (continued)

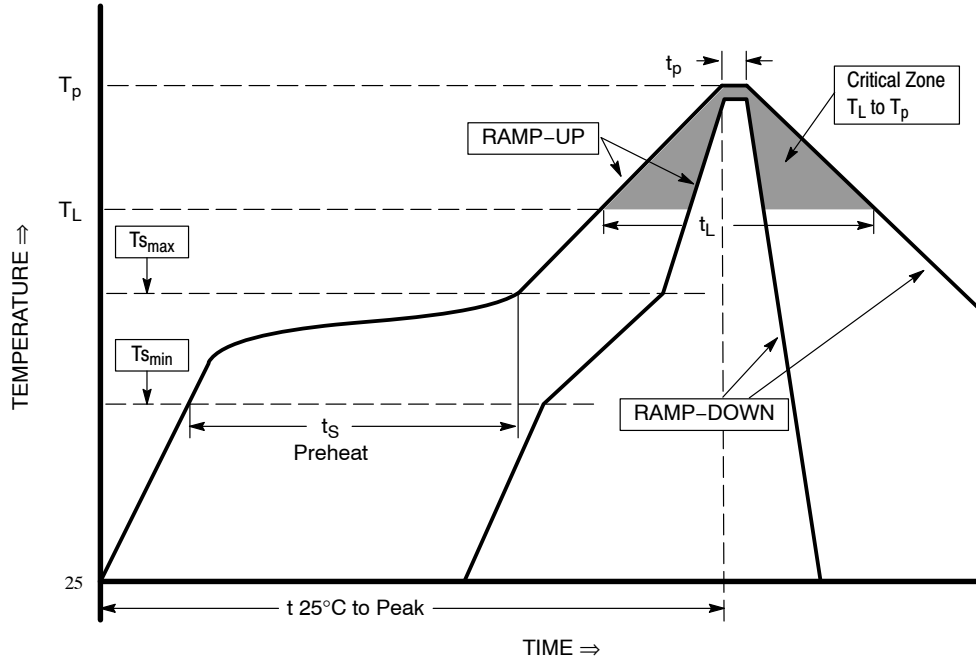

Figure 71. Typical Pb-Free Solder Heating Profile

Profile Feature	Pb-Free Assembly
Average Ramp-Up Rate ($T_{s_{max}}$ to T_p)	3°C/second max
Preheat Temperature Min ($T_{s_{min}}$) Temperature Max ($T_{s_{max}}$) Time ($t_{s_{min}}$ to $t_{s_{max}}$)	150°C 200°C 60-180 seconds
Time maintained above Temperature (T_T) Time (t_T)	217°C 60-150 seconds
Peak Classification Temperature (T_p)	260°C +5/-0
Time within 5°C of actual Peak Temperature (t_p)	20-40 seconds
Ramp-Down Rate	6°C/second max
Time 25°C to Peak Temperature	8 minutes max

BRD8011
AMBIENT MOUNTING DATA

Data shown for thermal resistance junction-to-ambient ($R_{\theta JA}$) for the mountings shown is to be used as typical guideline values for preliminary engineering or in case the tie point temperature cannot be measured.

TYPICAL VALUES FOR $R_{\theta JA}$ IN STILL AIR

Mounting Method	$R_{\theta JA}$	Lead Length, L (IN)				Units
		1/8	1/4	1/2	3/4	
1		50	51	53	55	$^{\circ}\text{C/W}$
2		58	59	61	63	$^{\circ}\text{C/W}$
3		28				$^{\circ}\text{C/W}$

MOUNTING METHOD 1

P.C. Board Where Available Copper Surface area is small.

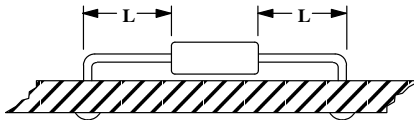

MOUNTING METHOD 2

Vector Push-In Terminals T-28

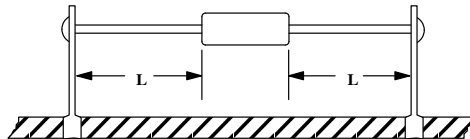

MOUNTING METHOD 3

P.C. Board with
 1-1/2" x 1-1/2" Copper Surface

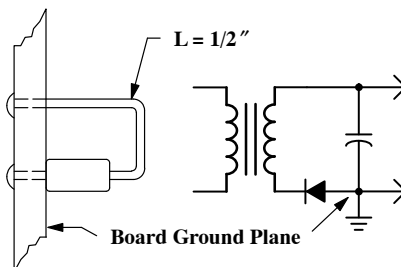

Humidity Indicator Card: Type HIC-0560

Objective

The objective of this information brief is to provide the customer with a general understanding of the humidity indicator cards (HIC) basic functions and a reaction plan based on the level of dryness as indicated on the card.

Introduction

The HIC is printed with moisture sensitive spots which will respond to variations of different levels of humidity with perceptible change in color typically from blue (dry) to pink (wet). The HIC is packed inside moisture barrier bags, which monitor the moisture inside the barrier bag. When the bag is opened, the HIC can be examined to determine the degree of dryness of the parts inside the bag.

Humidity Indicator Cards: HIC-0515 and HIC-0560

Excess humidity in the dry pack is noted by the HIC. It can occur due to misprocessing (e.g. missing or inadequate desiccant), mishandling (e.g. tears or rips in the moisture barrier bag) or improper storage.

The HIC should be read immediately upon removal from the moisture barrier bag. For best accuracy, the HIC should be read at $23\pm 5^{\circ}\text{C}$. The following conditions apply regardless of the storage time (whether or not the shelf life has exceeded).

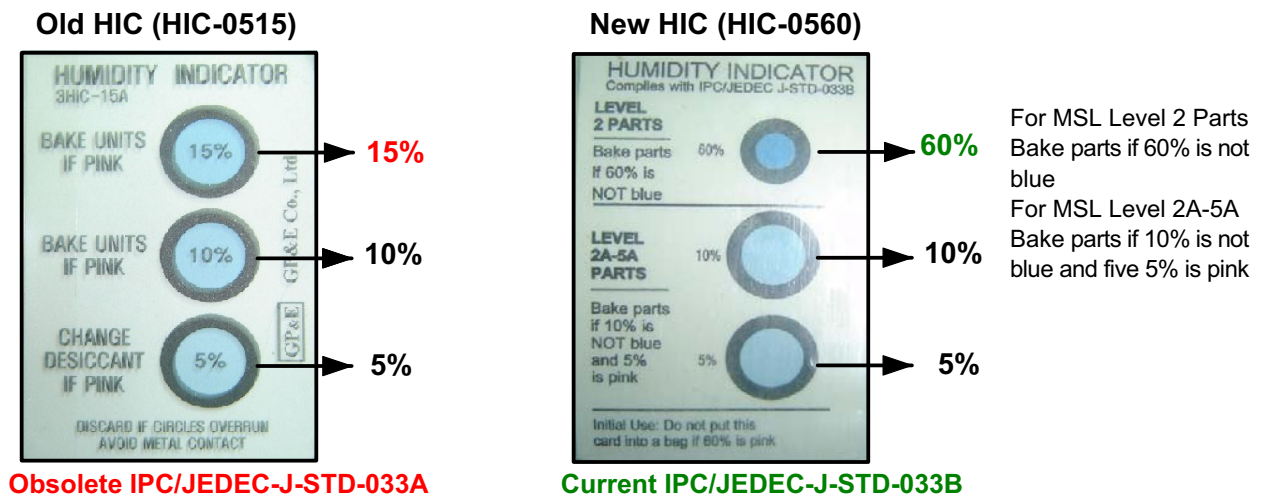

Figure 72. Humidity Indicator Card

Table 2: HIC Conditions and Corresponding Actions for HIC-0560

HIC Conditions	5%	10%	60%	Action	Remarks
Condition 1	Blue	Blue	Blue	No bake	Parts are dry
Condition 2	Pink	Blue	Blue	No bake	Only indicates that parts have 5% level of moisture
Condition 3	Pink	Pink	Blue	Bake required, refer to Table 2	Bake parts MSL levels 2a, 3, 4, 5, and 5a No need to bake MSL level 2
Condition 4	Pink	Pink	Pink	Bake required, refer to Table 2	All were parts were affected by moisture

BRD8011

Bake Duration for Exposed Parts

AMIS recommends that bake duration of exposed parts should comply with the existing provisions as mandated by Joint Industry Standard IPC/JEDEC-STD-033B entitled

“Handling, Packing and Use of Moisture/Reflow Sensitive Surface Mount Devices” Bake Duration for Exposed Parts as shown in Table 3.

Table 3: Reference Conditions for Drying Mounted or Unmounted SMD Packages (User bake: floor life beings counting at time = 0 after bake)

Package Body	Level	Bake @ 125°C		Bake @ 90°C ≤ 5% RH		Bake @ 40°C ≤ 5% RH	
		Exceeding Floor Life by > 72 h	Exceeding Floor Life by > 72 h	Exceeding Floor Life by > 72 h	Exceeding Floor Life by > 72 h	Exceeding Floor Life by > 72 h	Exceeding Floor Life by > 72 h
Thickness ≤ 1.4mm	2	5 hours	3 hours	17 hours	11 hours	8 days	5 days
	2a	7 hours	5 hours	23 hours	13 hours	9 days	7 days
	3	9 hours	7 hours	33 hours	23 hours	13 days	9 days
	4	11 hours	7 hours	37 hours	23 hours	15 days	9 days
	5	12 hours	7 hours	41 hours	24 hours	17 days	10 days
	5a	16 hours	10 hours	54 hours	24 hours	22 days	10 days
Thickness > 1.4mm ≤ 2.0mm	2	18 hours	15 hours	63 hours	2 days	25 days	20 days
	2a	21 hours	16 hours	3 days	2 days	29 days	22 days
	3	27 hours	17 hours	4 days	2 days	37 days	23 days
	4	34 hours	20 hours	5 days	3 days	47 days	28 days
	5	40 hours	25 hours	6 days	4 days	57 days	35 days
	5a	48 hours	40 hours	8 days	6 days	79 days	56 days
Thickness > 2.0mm ≤ 4.5mm	2	48 hours	48 hours	10 days	7 days	79 days	67 days
	2a	48 hours	48 hours	10 days	7 days	79 days	67 days
	3	48 hours	48 hours	10 days	8 days	79 days	67 days
	4	48 hours	48 hours	10 days	10 days	79 days	67 days
	5	48 hours	48 hours	10 days	10 days	79 days	67 days
	5a	48 hours	48 hours	10 days	10 days	79 days	67 days
BGA package > 17mm x 17mm or any stacked die package (Note 12)	2-6	96 hours	As above per package thickness and moisture level	Not applicable	As above per package thickness and moisture level	Not applicable	As above per package thickness and moisture level

NOTES:

11. Table 3 is based on worst-case molded lead frame SMD packages. Users may reduce the actual back time if technically justified (e.g. absorption/desorption data, etc.). In most cases it is applicable to other nonhermetic surface mount SMD packages.
12. For BGA packages > 17mm x >17 mm that do not have internal planes that block the moisture diffusion path in the substrate they may use bake times based on the thickness/moisture level portion of the table.

Sales and Design Assistance

Worldwide Technical Support
www.onsemi.com/support

For a comprehensive listing of
onsemi Sales Offices, Distributors,
and Rep Firms, please visit:

Americas & EMEA: www.onsemi.com/sales

China: www.onsemi.cn/sales

Japan: www.onsemi.jp/sales

onsemi

Intelligent Technology. Better Future.

Join us: www.onsemi.com/careers

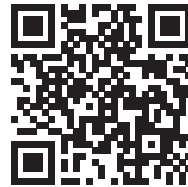

onsemi, ONSEMI, and other names, marks, and brands are registered and/or common law trademarks of Semiconductor Components Industries, LLC dba "onsemi" or its affiliates and/or subsidiaries in the United States and/or other countries. onsemi owns the rights to a number of patents, trademarks, copyrights, trade secrets, and other intellectual property. A listing of onsemi's product/patent coverage may be accessed at www.onsemi.com/site/pdf/Patent-Marking.pdf. onsemi reserves the right to make changes at any time to any products or information herein, without notice. The information herein is provided "as-is" and onsemi makes no warranty, representation or guarantee regarding the accuracy of the information, product features, availability, functionality, or suitability of its products for any particular purpose, nor does onsemi assume any liability arising out of the application or use of any product or circuit, and specifically disclaims any and all liability, including without limitation special, consequential or incidental damages. Buyer is responsible for its products and applications using onsemi products, including compliance with all laws, regulations and safety requirements or standards, regardless of any support or applications information provided by onsemi. "Typical" parameters which may be provided in onsemi data sheets and/or specifications can and do vary in different applications and actual performance may vary over time. All operating parameters, including "Typicals" must be validated for each customer application by customer's technical experts. onsemi does not convey any license under any of its intellectual property rights nor the rights of others. onsemi products are not designed, intended, or authorized for use as a critical component in life support systems or any FDA Class 3 medical devices or medical devices with a same or similar classification in a foreign jurisdiction or any devices intended for implantation in the human body. Should Buyer purchase or use onsemi products for any such unintended or unauthorized application, Buyer shall indemnify and hold onsemi and its officers, employees, subsidiaries, affiliates, and distributors harmless against all claims, costs, damages, and expenses, and reasonable attorney fees arising out of, directly or indirectly, any claim of personal injury or death associated with such unintended or unauthorized use, even if such claim alleges that onsemi was negligent regarding the design or manufacture of the part. onsemi is an Equal Opportunity/Affirmative Action Employer. This literature is subject to all applicable copyright laws and is not for resale in any manner.

ADDITIONAL INFORMATION

TECHNICAL PUBLICATIONS

Technical Library: www.onsemi.com/design/resources/technical-documentation
onsemi Website: www.onsemi.com

ONLINE SUPPORT: www.onsemi.com/support

For additional information, please contact your local Sales Representative at
www.onsemi.com/support/sales