



Test Procedure for the NCP130AMX090TCG Demo Board

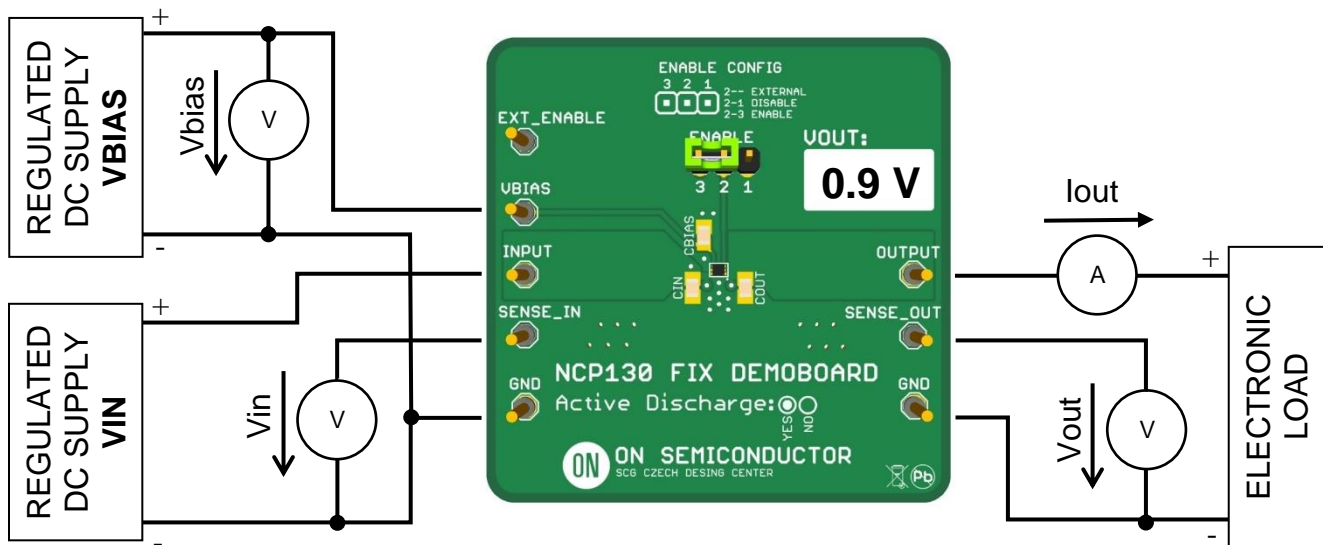

Figure 1: Test Setup

Test Procedure

1. Connect the test setup as shown in Figure 1.
2. Apply supply voltage $V_{bias} = 5.5 \text{ V}$
3. Apply supply voltage $V_{in} = 1.2 \text{ V}$
4. Apply $I_{out} = 10 \text{ mA}$ load.
5. Check the Output Voltage $V_{out} = 0.9 \text{ V} \pm 1.5\%$
6. Increase I_{out} load current to 0.3 A
7. Check the Output Voltage $V_{out} = 0.9 \text{ V} \pm 1.5\%$
8. Power down the load
9. Power down V_{in} and V_{bias} supply
10. End of test