

Schematic for the NCP702SN30T1GEVB Evaluation Board

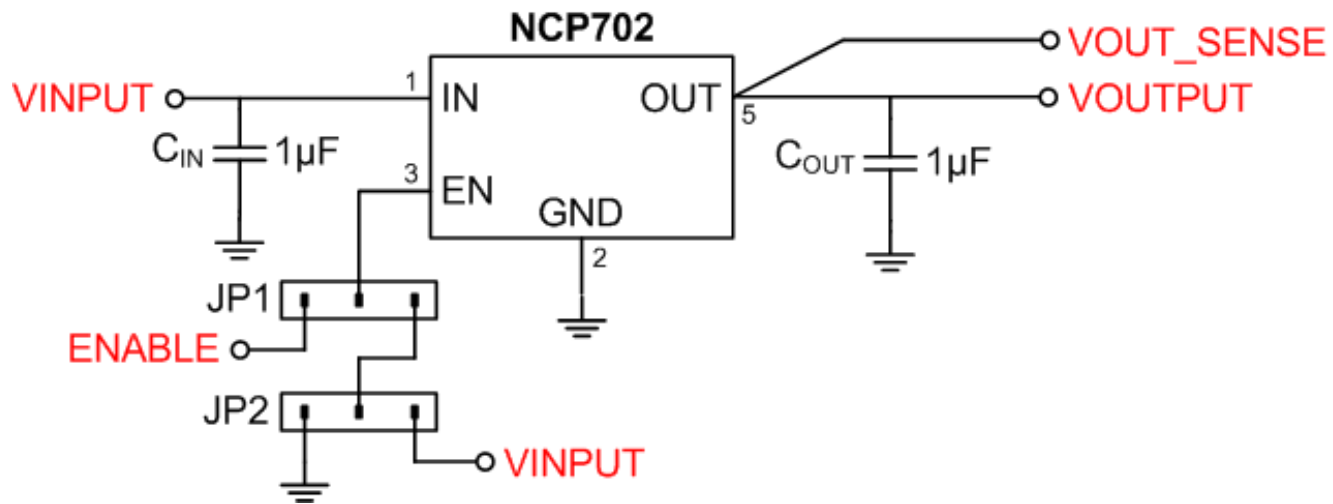

NCP702, 200mA, Ultra-Low Noise LDO PCB Schematic