

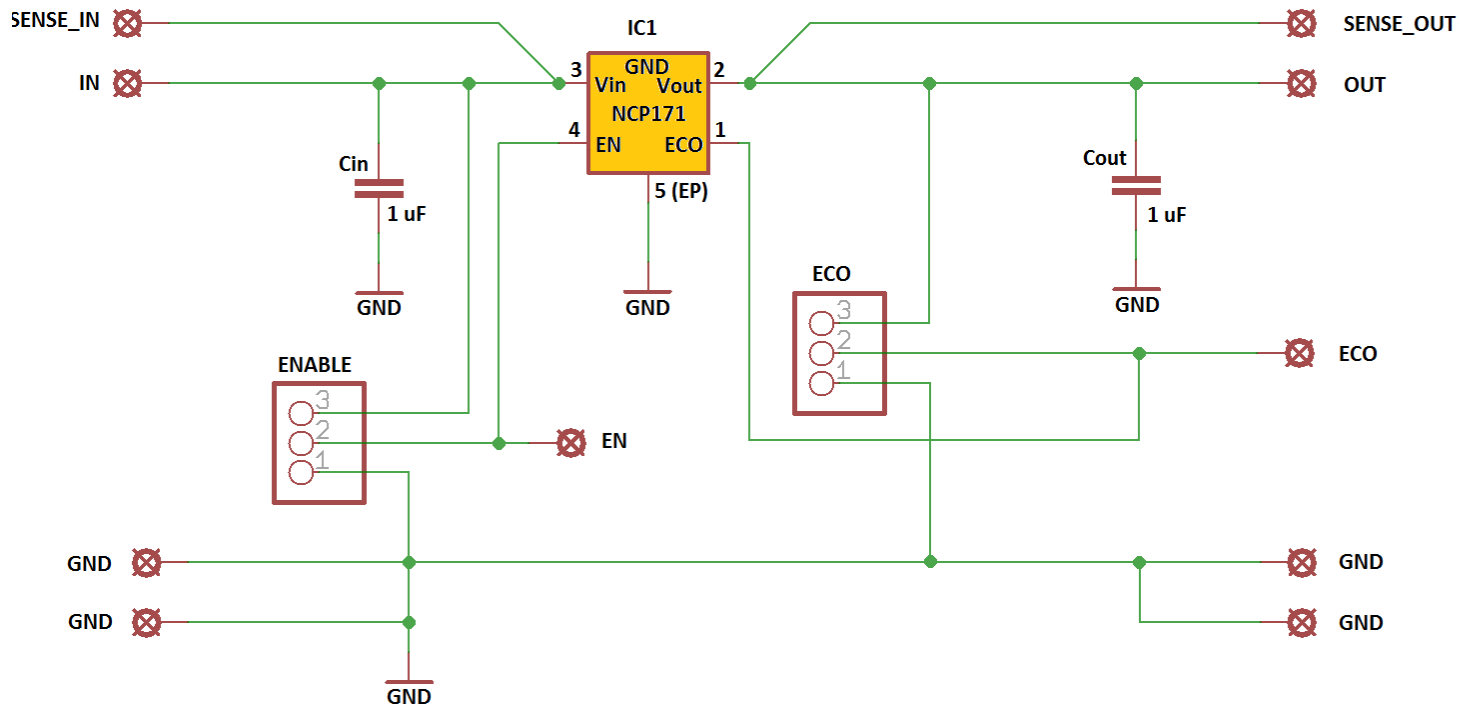

ON Semiconductor

## Schematic for the NCP171AMX330325TCG LDO Demoboard



### Programming I/F

