

Schematic for the NCP170AXV120GEVB Evaluation Board

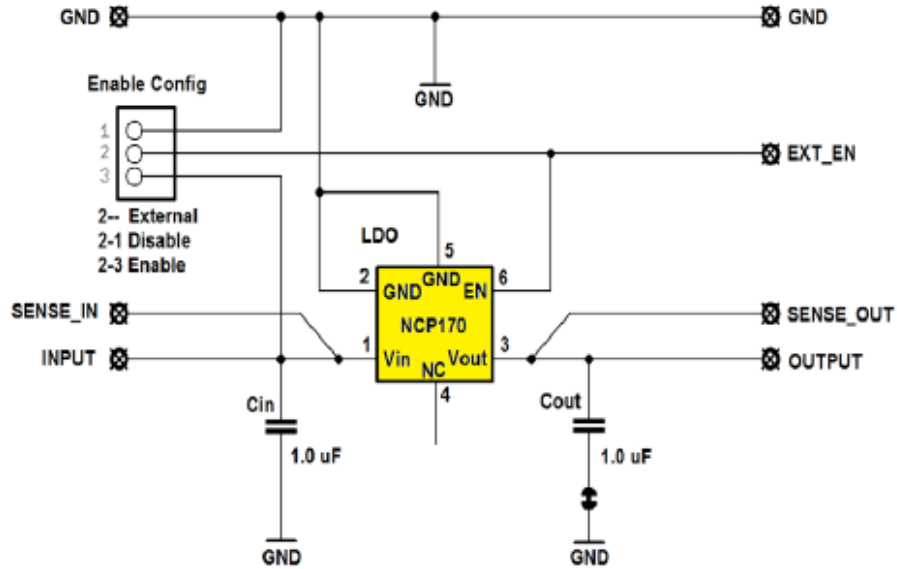

Programming I/F

