

Schematic for the NCL30076LED1GEVB Evaluation Board

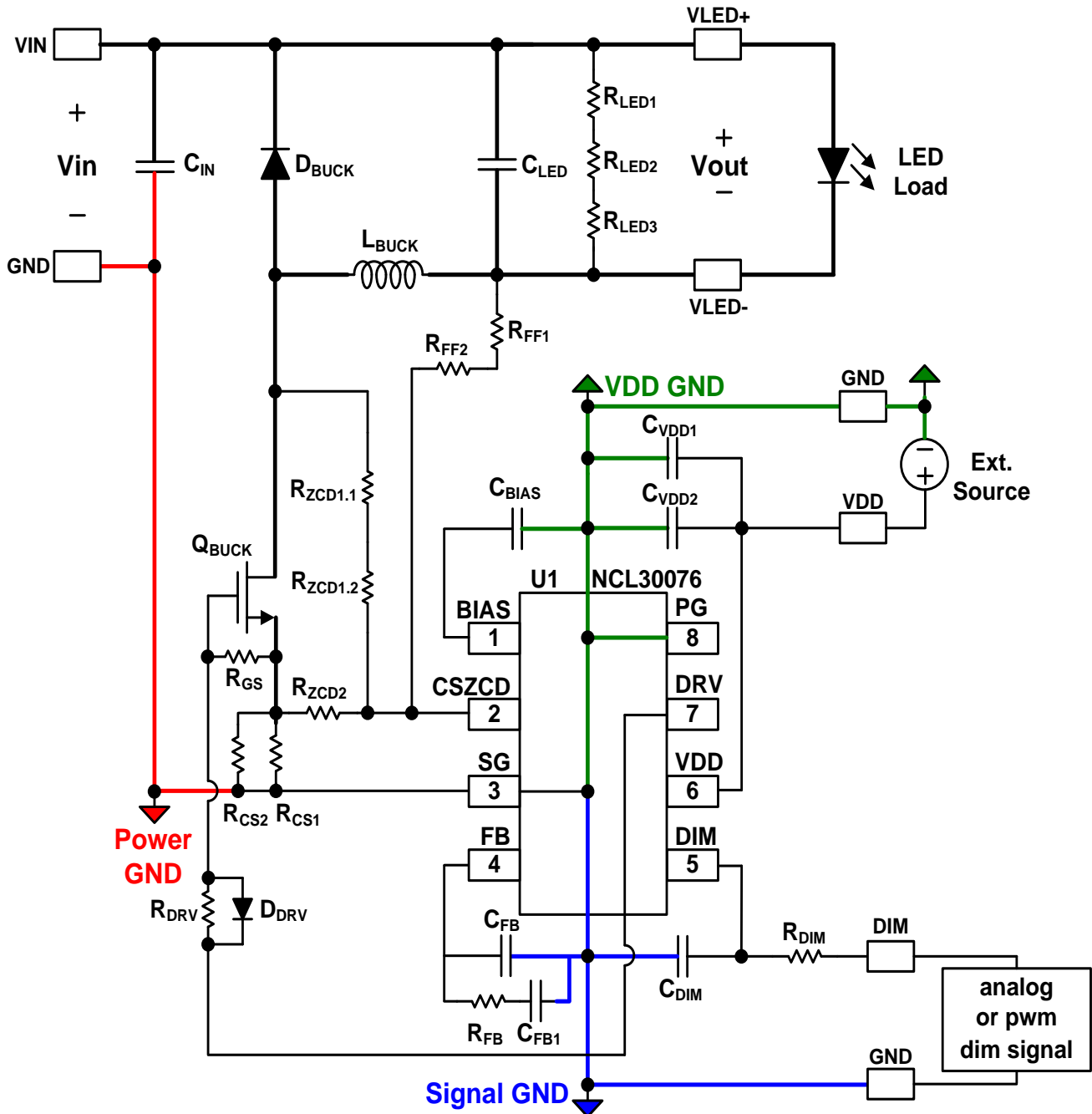

Figure 1. Schematic for NCL30076 100-W Design Reference