

A 12-V/1-A Primary Side Regulated Isolated Flyback Converter for Automotive Applications

NCV12711PSRGEVB

SPECIFICATION

Devices	Applications	Input Voltage	Output Power	Topology	Board Size
NCV12711	Automotive	4 – 45 V dc	12 W	Current-Mode Flyback	100 x 47 x 15 mm
Output Spec.	Turn on Time	Efficiency	Operating Temperature	Cooling	Standby Power
12 V/1 A	< 100 ms	Peaks to 88 % @ full load	0 – 50°C	Open Frame in Still Air	See the tables on page 12

DESCRIPTION

This evaluation board user's manual provides elementary information about a primary-side-regulated flyback converter NCV12711PSRGEVB built with the NCV12711 operated in current-mode control at 100 kHz. This control circuit offers many features to build an energy-efficient converter with all the needed protections like cycle-by-cycle current limit with a 250-mV sense voltage, over-current protection (OCP) and over-voltage protection (OVP) on the VCC pin. The controller drives an N-channel MOSFET as with any classical flyback converter at a user-adjustable switching frequency. The secondary side hosts a low- V_f diode for efficient rectification in continuous conduction mode (CCM).

The primary-side section drives a transformer whose primary inductance is 8 μ H. The current is sensed via two paralleled 40-m Ω resistors which limit the maximum output current to a safe value in fault condition. The board is rated to 12 W of continuous output power in free air at the lowest input voltage. This level is delivered down to a 4.5-V input. The converter is able to deliver output power up to 4-V input, which is the turn-off level adjusted by an UVLO resistor divider. At higher input voltages, the board may deliver more power but thermal runaway may happen and the board temperature must be monitored.

The regulation is ensured via an auxiliary winding, avoiding the use of an optocoupler. The winding is first filtered via R_{18}/C_{19} and helps lowering the leakage inductance peak naturally present in the transformer voltage. Then diode D_4 with capacitor C_{12} provide adequate rectification to build a clean dc voltage. The switches let you select different configurations to test the circuit:

1. a is closed, b open: in this mode, the VCC and VIN pin are connected together while the auxiliary dc

serves for regulation purposes only. The maximum input voltage is 25 V; going beyond this value will trip the OVP on VCC pin.

2. b is closed, a open: in this mode, the controller is supplied by the VIN pin only during start-up sequence and V_{CC} is biased by the rectified auxiliary supply. The input voltage can go up to 45 V.
3. a and b are open: the controller is self-supplied via internal LDO and the auxiliary winding only serves for regulation purposes. The input voltage can go up to 45 V.

In the above three modes, 1. and 3. offer the best regulation figure because the load is constant across capacitor C_{12} . However, in 1. the input voltage is limited to 25 V while in 3., power dissipation might be at stake if you drive a large- Q_G MOSFET at a high switching frequency.

The internal operational amplifier coupled to external components ensures the realization of a type 2 compensator. Using the simulation model or a bench measurement, components values were adjusted to crossover above 1 kHz. The maximum crossover is limited by the right-half-plane-zero (RHPZ) which degrades the phase response at the lowest input voltage and the largest output current. The board is equipped with two connectors letting you easily connect the network analyzers probes for a convenient measurement. The collected graphs show a comfortable phase margin at crossover.

A simple front-end filter limits the amount of parasitic noise going back to the source and it must be properly damped to avoid interaction with the downstream converter. C_9 is providing that function with its equivalent series resistance (ESR).

NCV12711PSRGEVB

KEY FEATURES OF NCV12711

- Internal 20-mA current source for lossless start-up sequence and self-supply operation
- Smooth start-up sequence with frequency sweep
- Internal operational amplifier with precise 2.5-V reference voltage
- Current-mode control operation
- Short circuit protection
- Over voltage protection
- Input Voltage UVLO with Hysteresis
- Shutdown threshold for external disable
- 0% duty ratio mode for low standby power
- Single Resistor Programmable Oscillator
- User-Adjustable Soft-Start Ramp

BOARD PICTURES

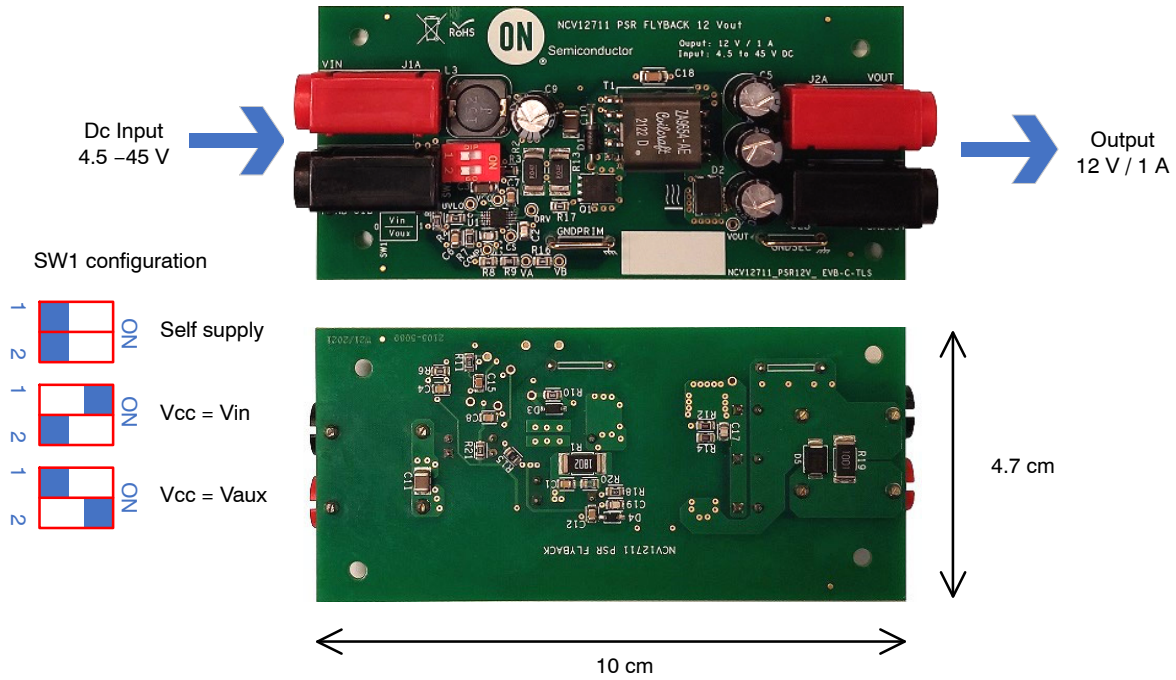

Figure 1. Top/Bottom Photo of the NCV12711PSRGEVB Evaluation Board

NCV12711PSRGEVB

EVALUATION BOARD SCHEMATIC DIAGRAM

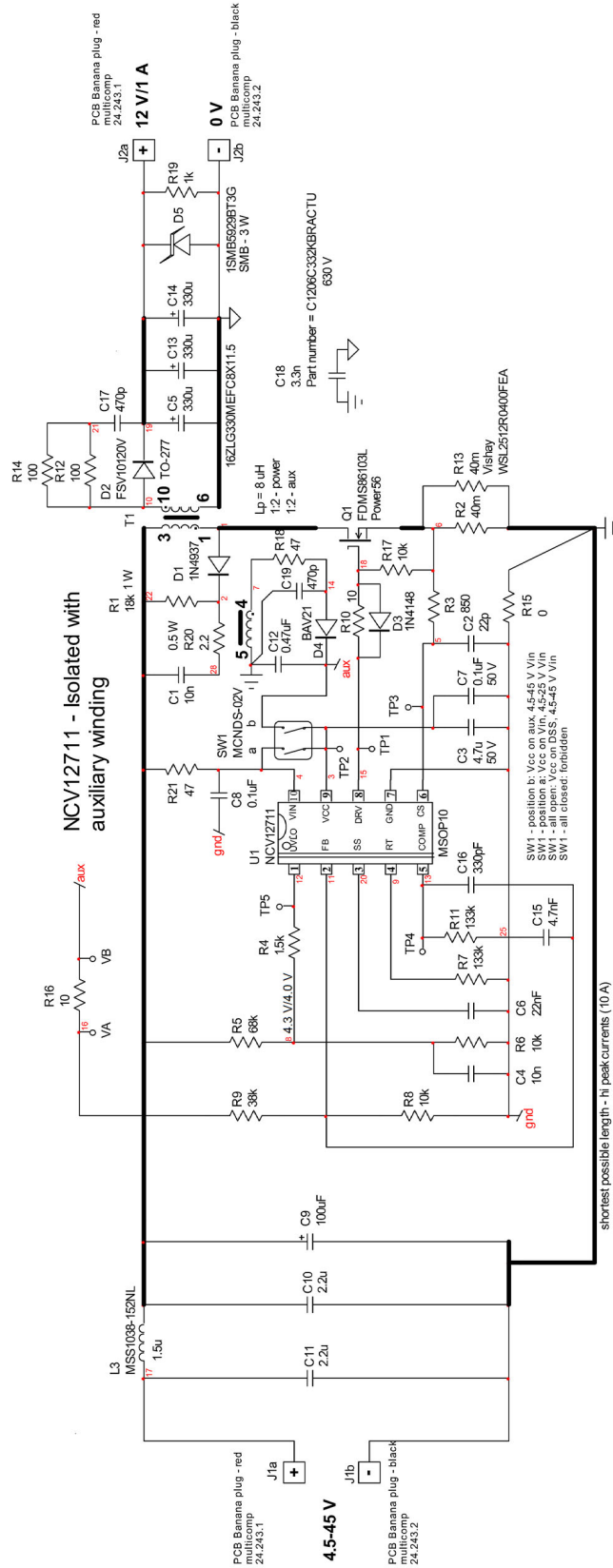

Figure 2. Schematic of the NCV12711PSRGEVB Evaluation Board

NCV12711PSRGEVB

MAGNETICS DATA

ZA9654-AE from Coilcraft:

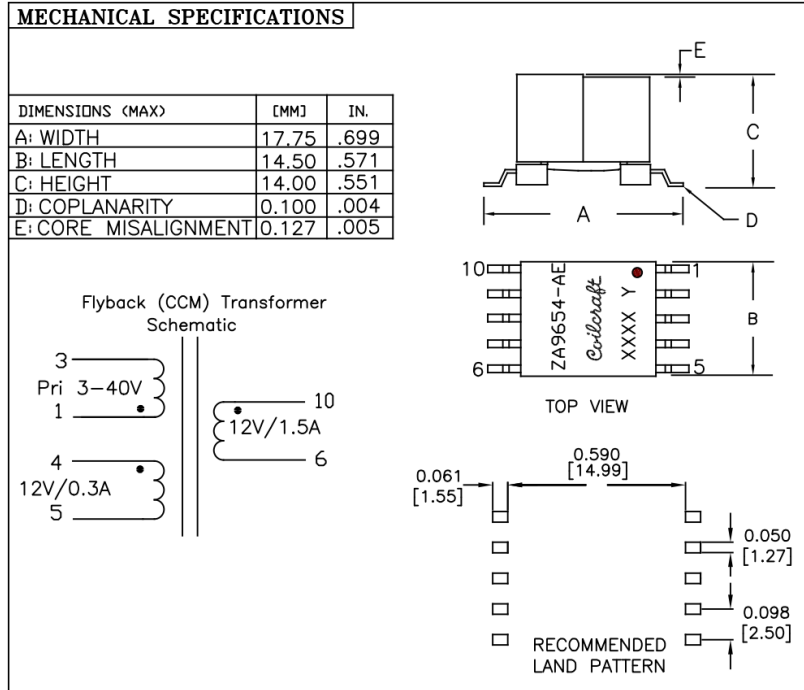

Figure 3. Mechanical Specifications

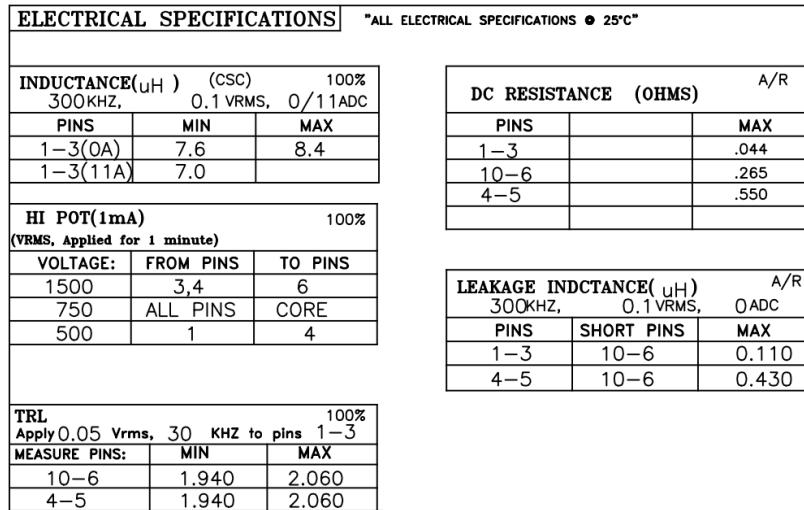

Figure 4. Electrical Specifications

TEST DATA

Startup Time

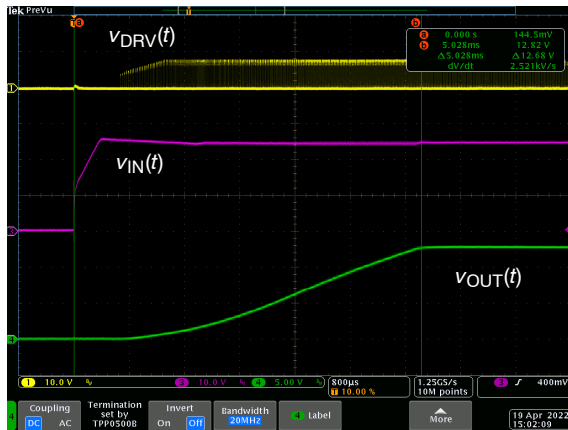

Figure 5. Self-supplied, $V_{IN} = 25\text{ V}$, $I_{OUT} = 0\text{ A}$, $t_{\text{startup}} = 5.0\text{ ms}$

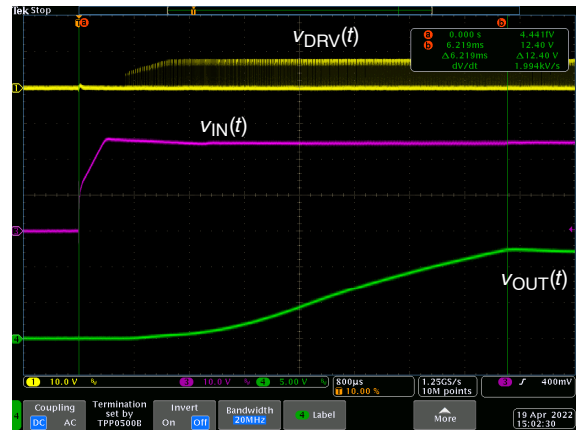

Figure 6. Self-supplied, $V_{IN} = 25\text{ V}$, $I_{OUT} = 1\text{ A}$, $t_{\text{startup}} = 6.2\text{ ms}$

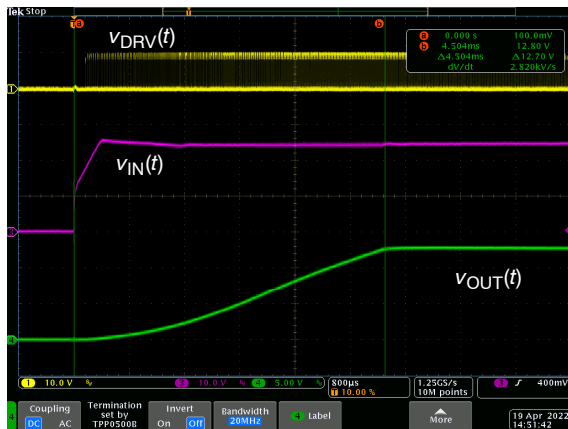

Figure 7. $V_{CC} = V_{IN}$, $V_{IN} = 25\text{ V}$, $I_{OUT} = 0\text{ A}$, $t_{\text{startup}} = 4.5\text{ ms}$

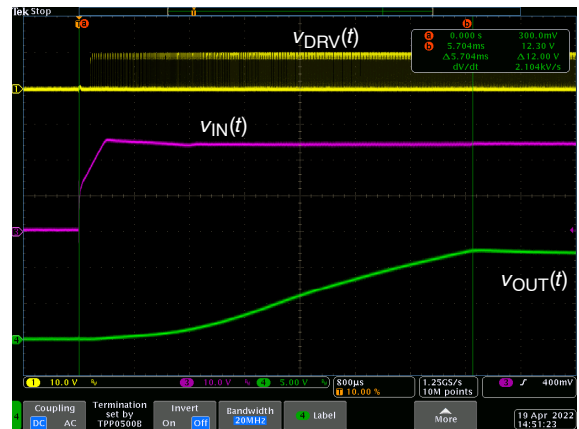

Figure 8. $V_{CC} = V_{IN}$, $V_{IN} = 25\text{ V}$, $I_{OUT} = 1\text{ A}$, $t_{\text{startup}} = 5.7\text{ ms}$

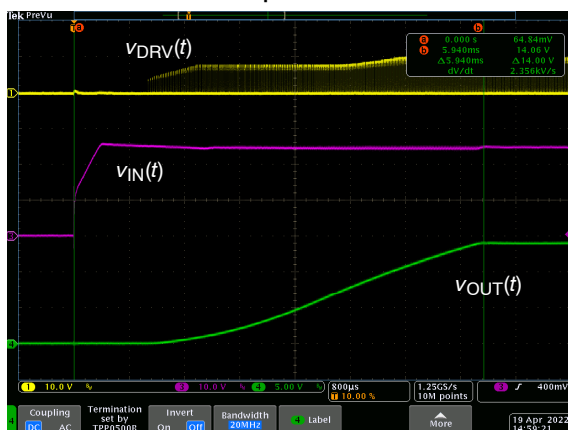

Figure 9. $V_{CC} = V_{aux}$, $V_{IN} = 25\text{ V}$, $I_{OUT} = 0\text{ A}$, $t_{\text{startup}} = 5.9\text{ ms}$

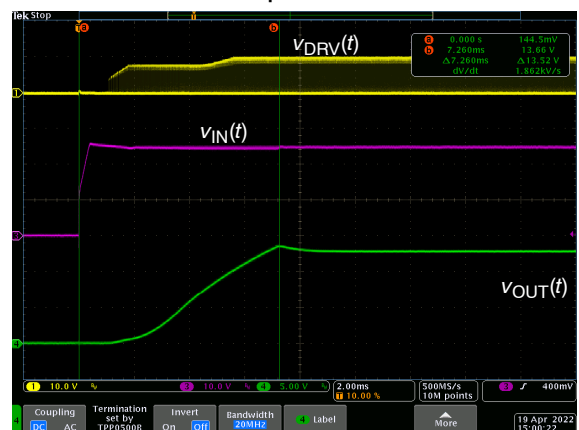

Figure 10. $V_{CC} = V_{aux}$, $V_{IN} = 25\text{ V}$, $I_{OUT} = 1\text{ A}$, $t_{\text{startup}} = 7.3\text{ ms}$

Steady-state Operation

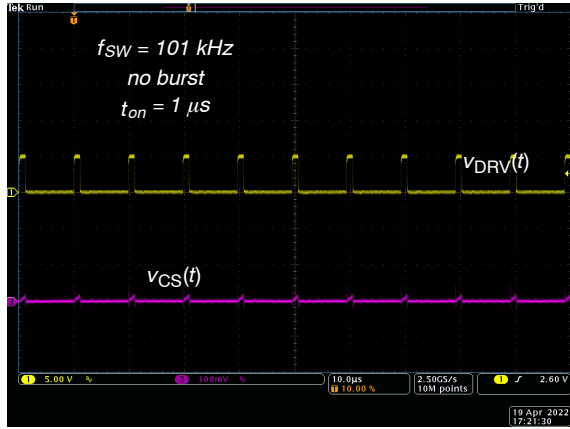

Figure 11. $V_{IN} = 5.5 \text{ V}$, $I_{OUT} = 0 \text{ A}$

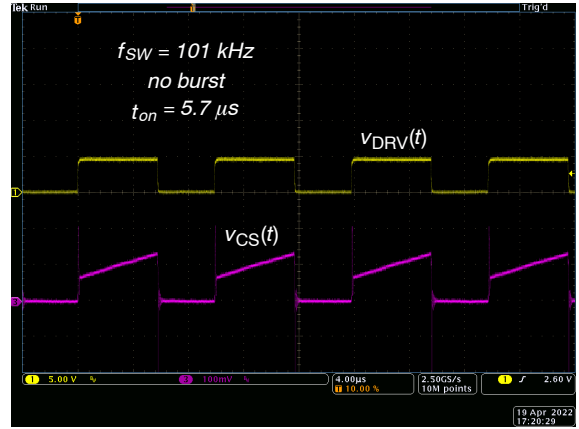

Figure 12. $V_{IN} = 5.5 \text{ V}$, $I_{OUT} = 1 \text{ A}$

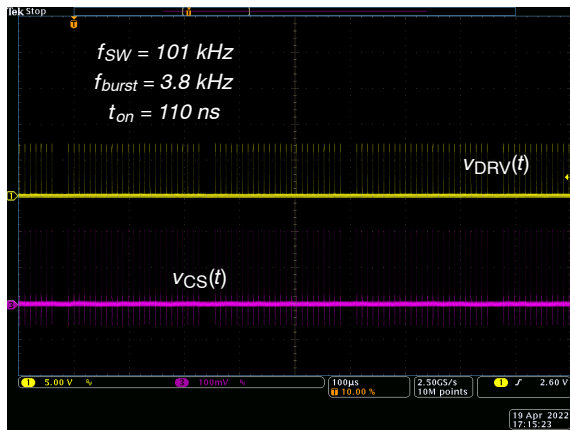

Figure 13. $V_{IN} = 25 \text{ V}$, $I_{OUT} = 0 \text{ A}$

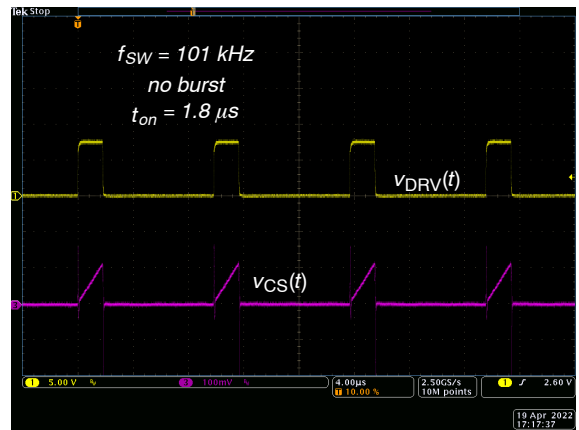

Figure 14. $V_{IN} = 25 \text{ V}$, $I_{OUT} = 1 \text{ A}$

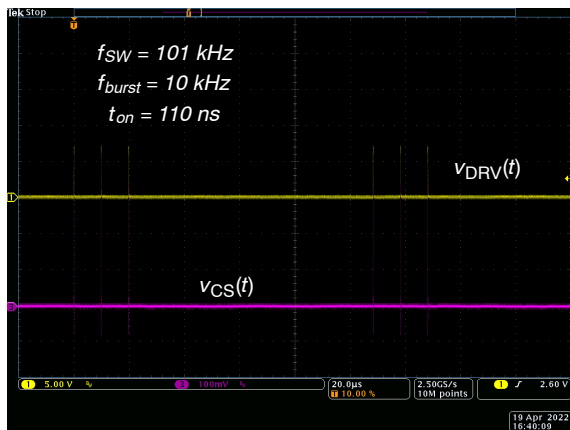

Figure 15. $V_{IN} = 45 \text{ V}$, $I_{OUT} = 0 \text{ A}$

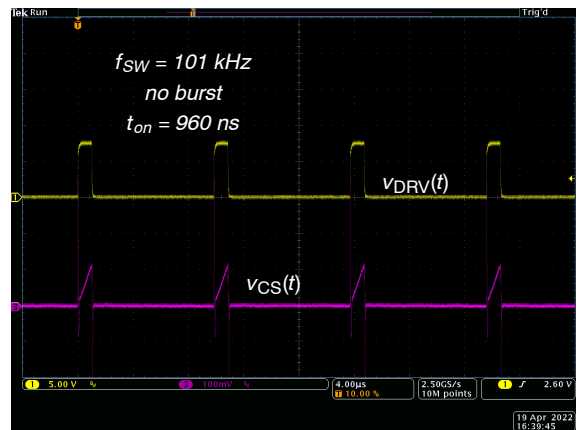

Figure 16. $V_{IN} = 45 \text{ V}$, $I_{OUT} = 1 \text{ A}$

Load Transient Response

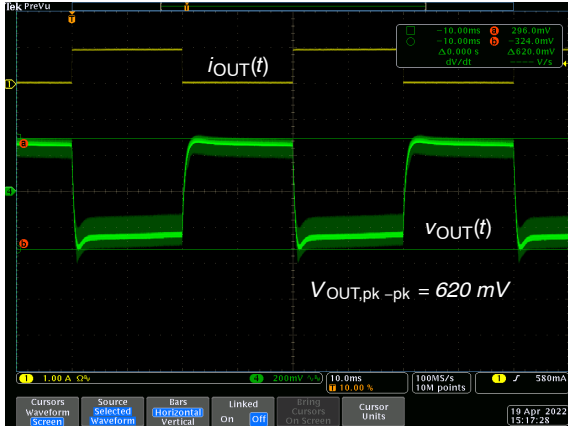

Figure 17. Self-supplied, $V_{IN} = 25\text{ V}$, I_{OUT} = from 0.1 A to 1 A, Slew Rate 0.5 A/ μ s

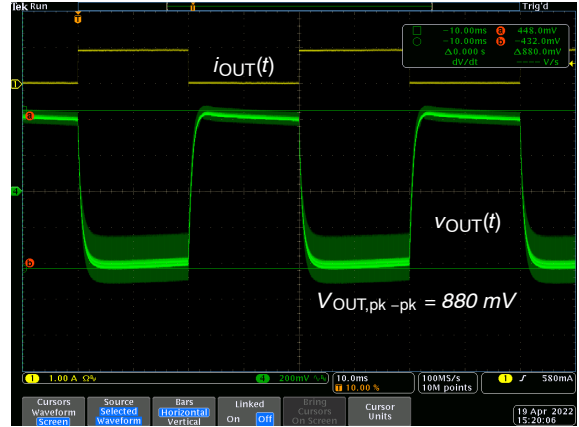

Figure 18. Self-supplied, $V_{IN} = 5.5\text{ V}$, I_{OUT} = from 0.1 A to 1 A, Slew Rate 0.5 A/ μ s

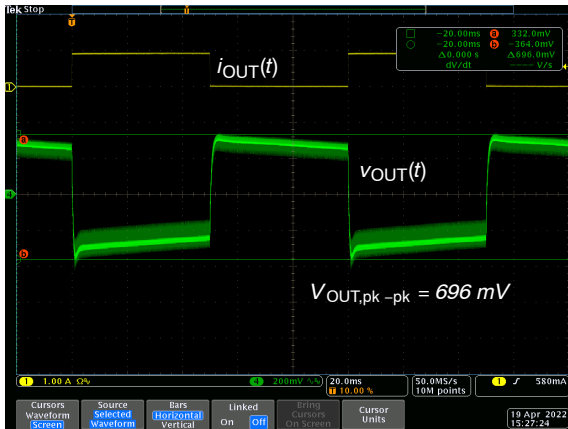

Figure 19. VCC = V_{IN} , $V_{IN} = 25\text{ V}$, I_{OUT} = from 0.1 A to 1 A, Slew Rate 0.5 A/ μ s

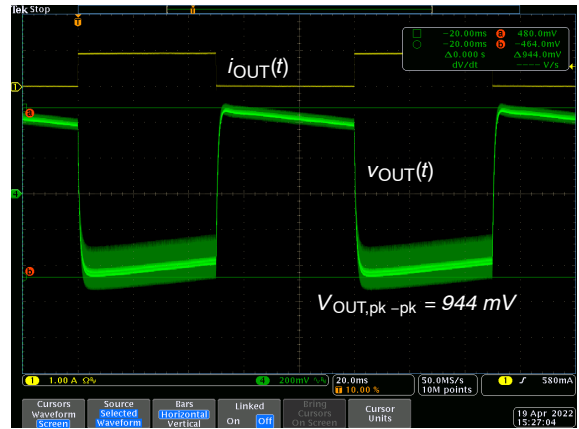

Figure 20. VCC = V_{IN} , $V_{IN} = 5.5\text{ V}$, I_{OUT} = from 0.1 A to 1 A, Slew Rate 0.5 A/ μ s

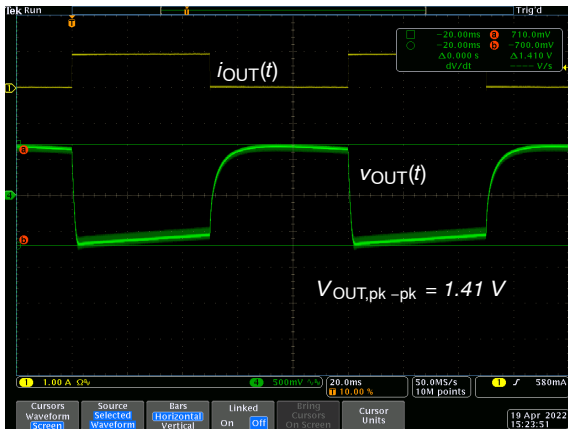

Figure 21. VCC = V_{aux} , $V_{IN} = 25\text{ V}$, I_{OUT} = from 0.1 A to 1 A, Slew Rate 0.5 A/ μ s

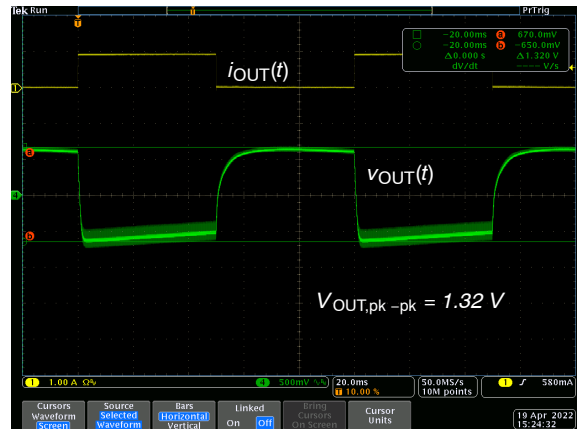

Figure 22. VCC = V_{aux} , $V_{IN} = 5.5\text{ V}$, I_{OUT} = from 0.1 A to 1 A, Slew Rate 0.5 A/ μ s

Output Voltage Ripple

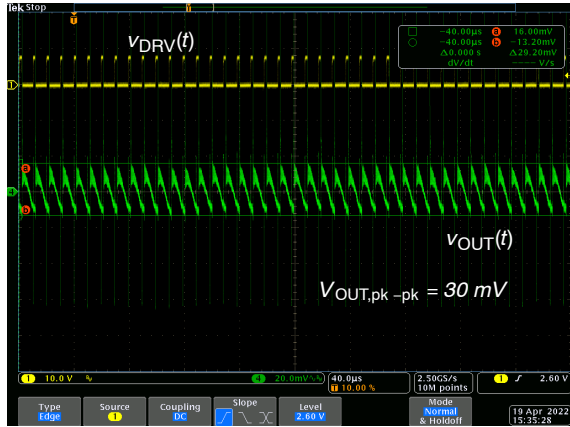

Figure 23. $V_{IN} = 25\text{ V}$, $I_{OUT} = 1\text{ A}$

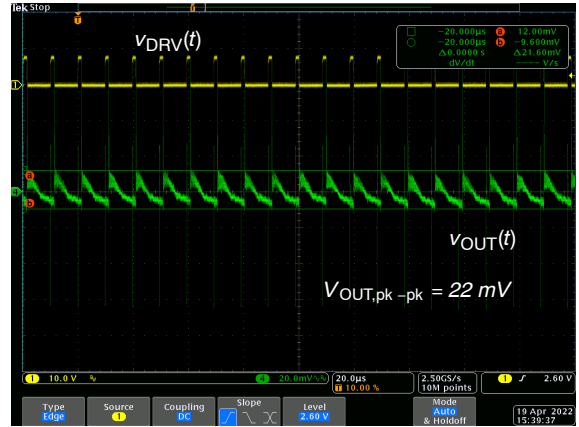

Figure 24. $V_{IN} = 25\text{ V}$, $I_{OUT} = 0.5\text{ A}$

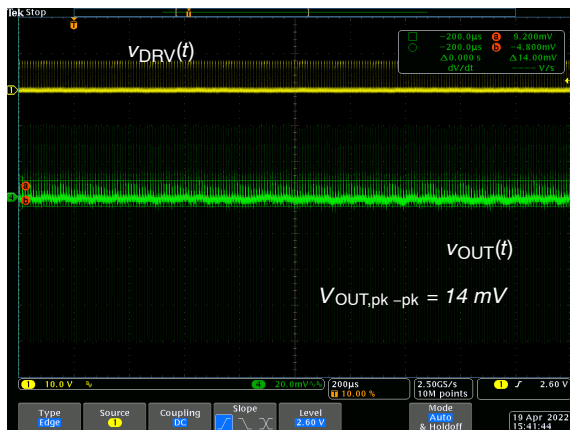

Figure 25. $V_{IN} = 25\text{ V}$, $I_{OUT} = 0.1\text{ A}$

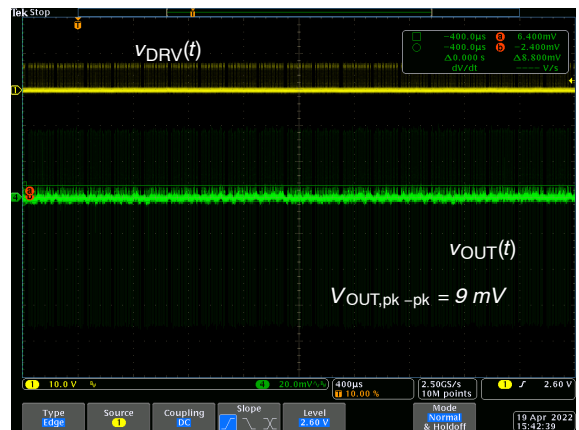

Figure 26. $V_{IN} = 25\text{ V}$, $I_{OUT} = 0.0\text{ A}$

Drain-Source Voltage

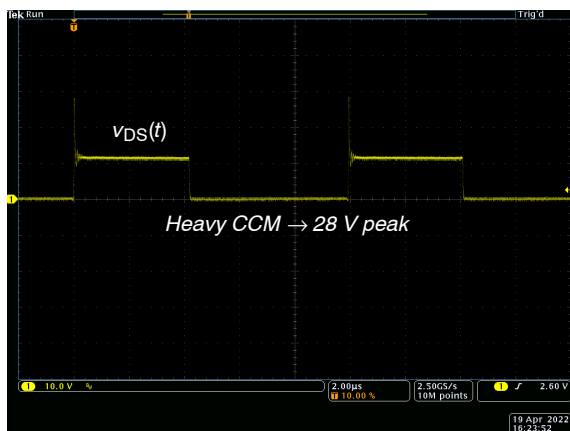

Figure 27. $V_{IN} = 25\text{ V}$, $I_{OUT} = 1\text{ A}$

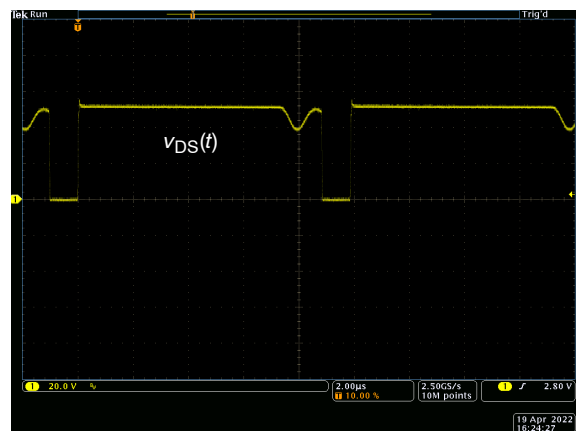

Figure 28. $V_{IN} = 25\text{ V}$, $I_{OUT} = 0.5\text{ A}$

NCV12711PSRGEVB

Loop gain Bode plots:

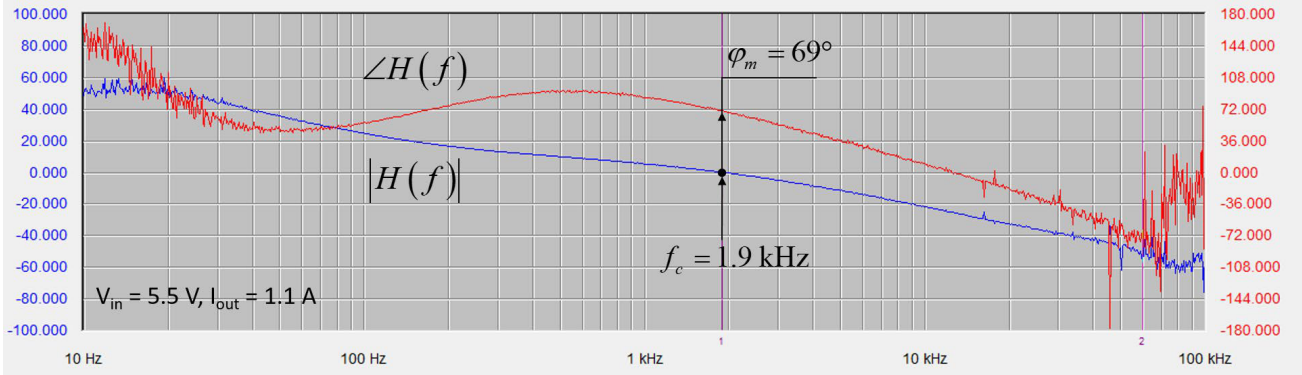

Figure 29. This is the Loop Gain when Probes across Test Points A and B. $V_{in} = 5.5$ V, Switch in Position *b*.

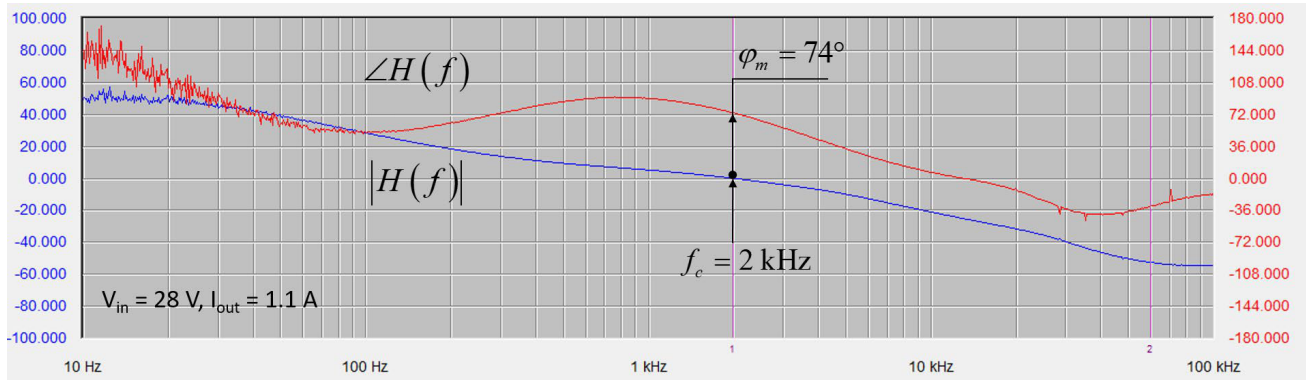

Figure 30. This is the Loop Gain when Probes across Test Points A and B. $V_{in} = 28$ V, Switch in Position *b*.

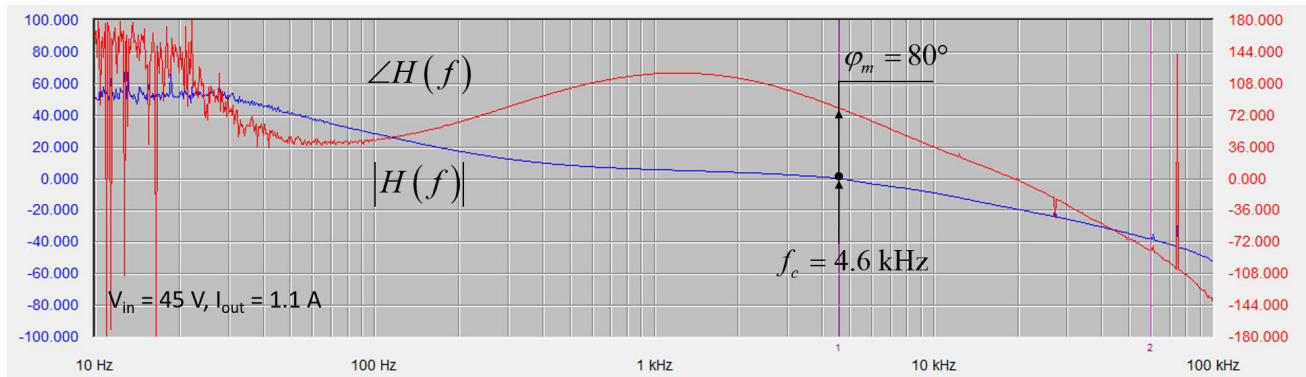

Figure 31. This is the Loop Gain when Probes across Test Points A and B. $V_{in} = 45$ V, Switch in Position *a*.

NCV12711PSRGEVB

Regulation Data

For all regulation measurements, the dummy load 1 k Ω (R19) and Zener diode D5 were removed.

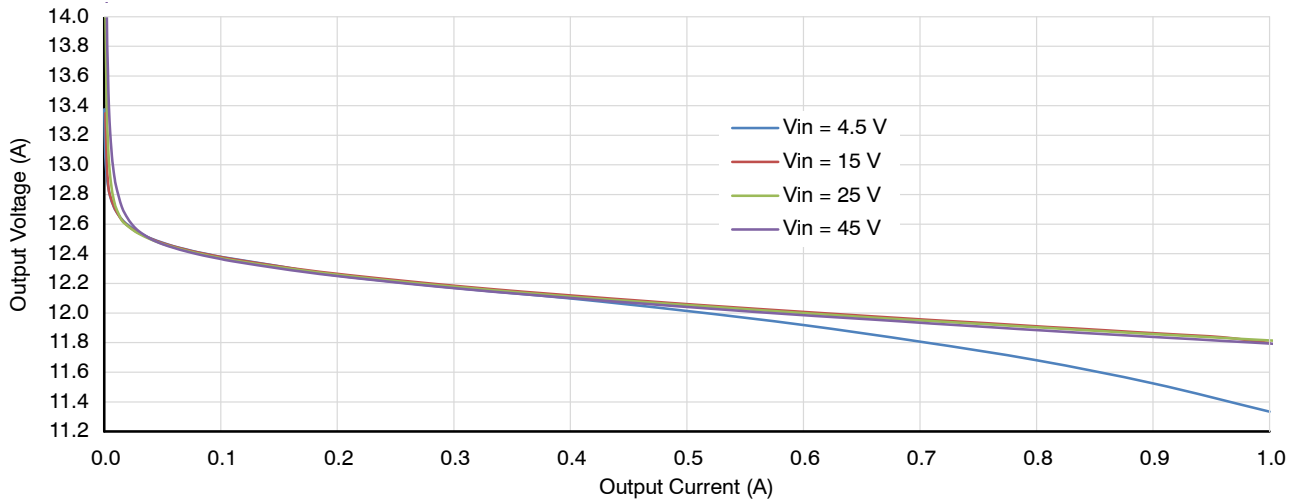

Figure 32. Output Voltage Variation with Load Current when IC is Self-supplied via LDO

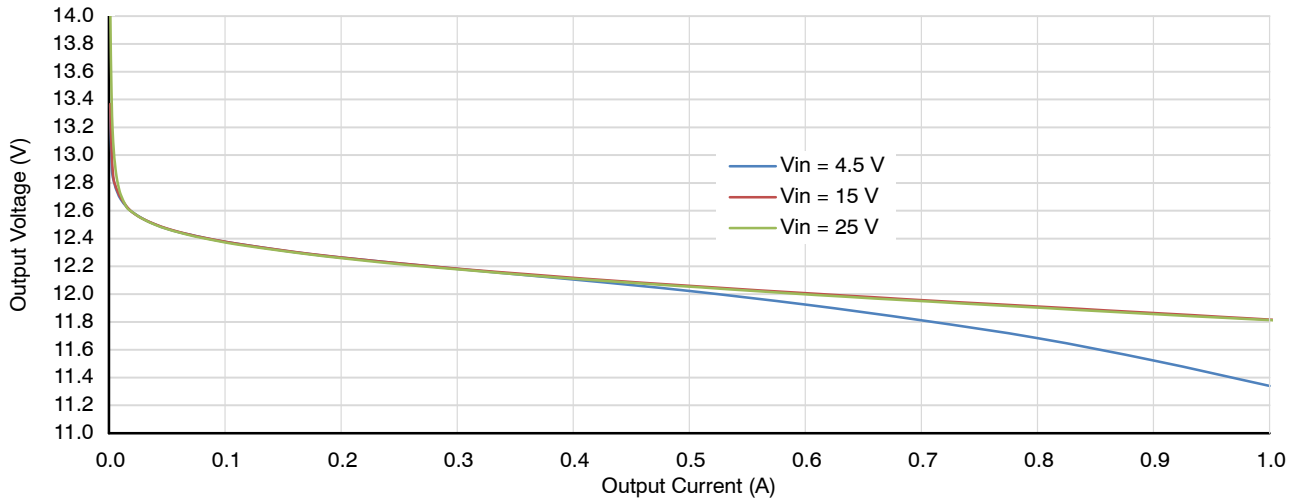

Figure 33. Output Voltage Variation with Load Current when VCC Pin is Connected to VIN Pin

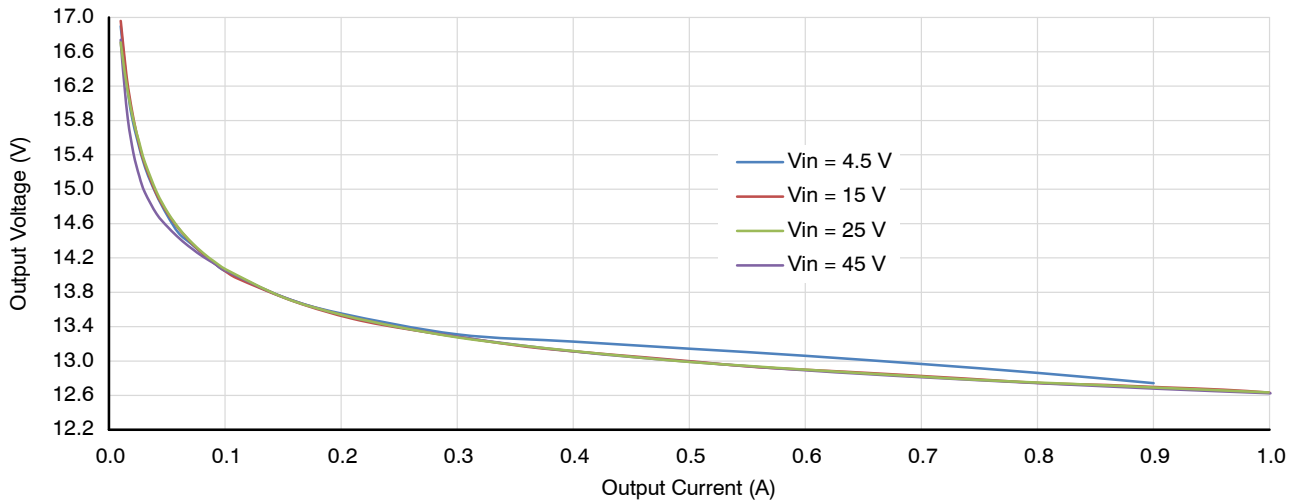

Figure 34. Output Voltage Variation with Load Current when VCC Pin is Connected to AUX Winding

NCV12711PSRGEVB

Efficiency Data

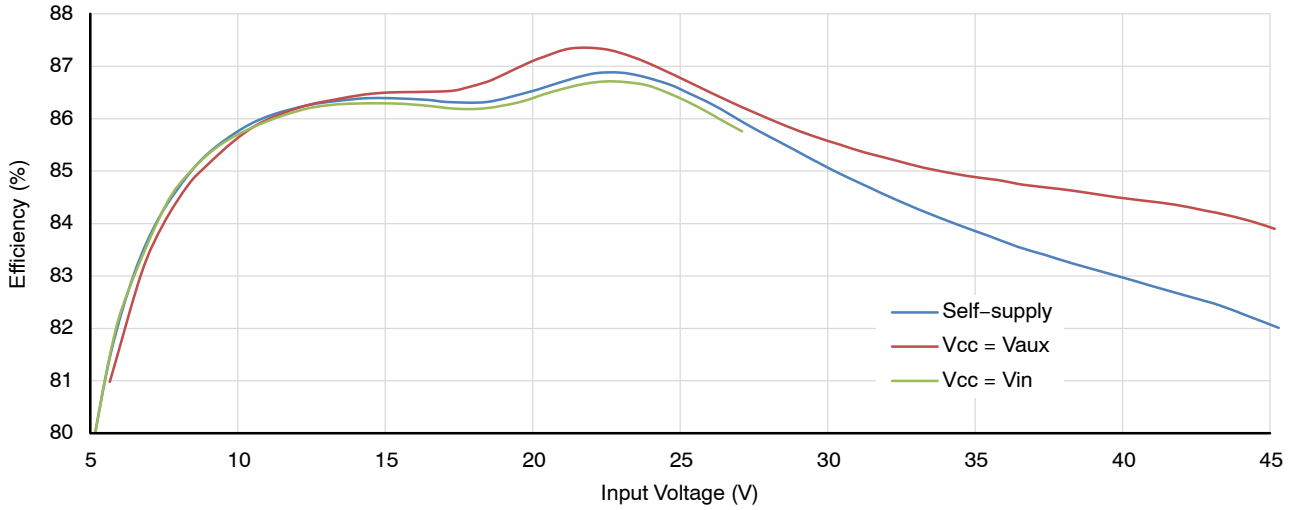

Figure 35. Efficiency vs. Input Voltage for Load Current 1 A

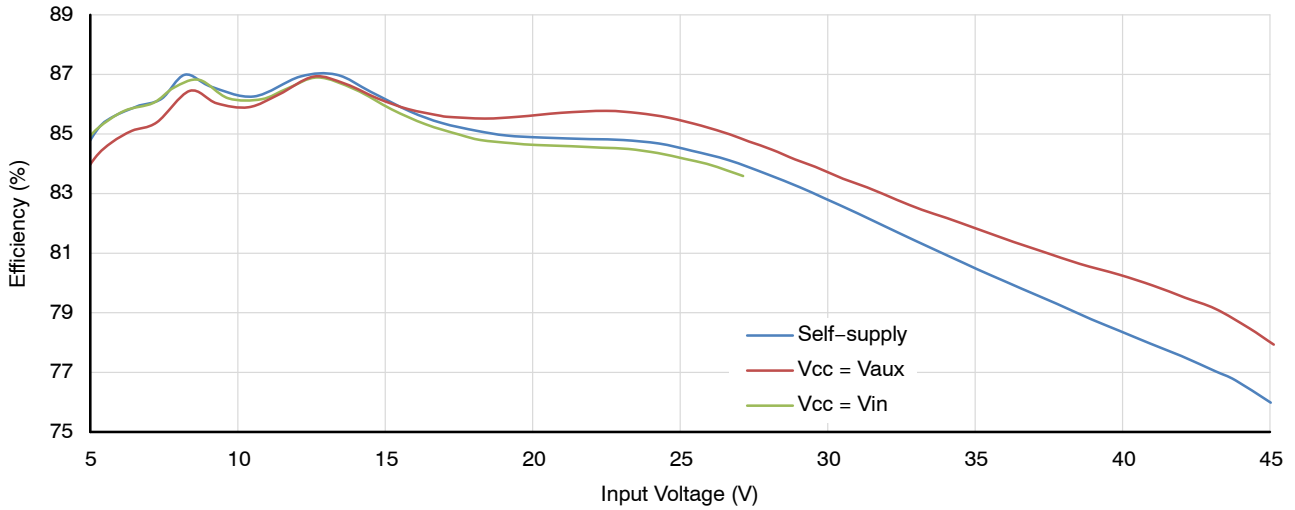

Figure 36. Efficiency vs. Input Voltage for Load Current 0.5 A

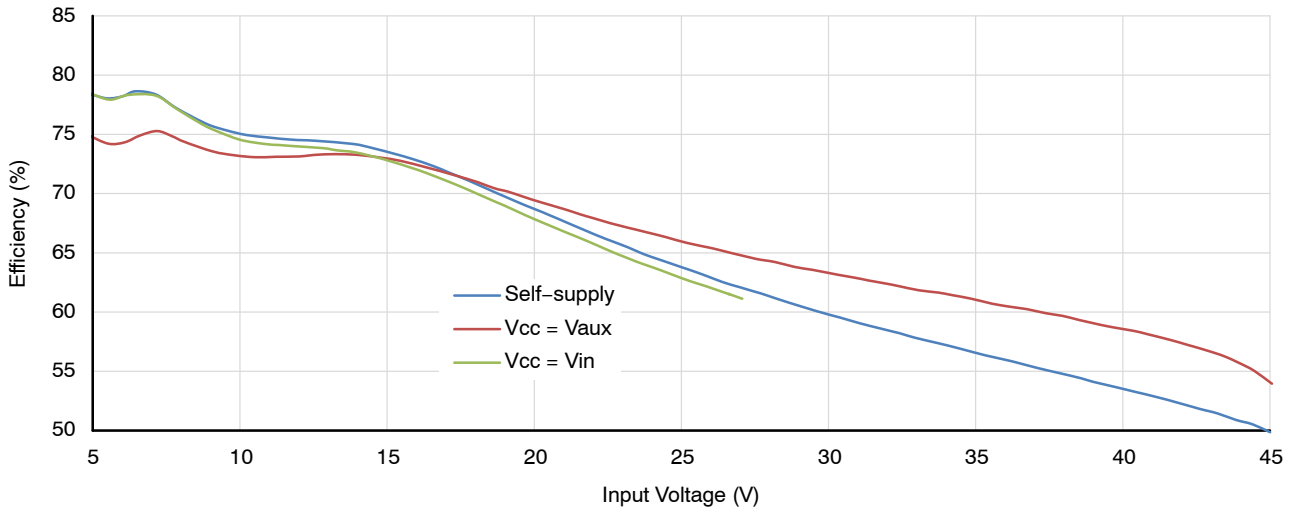

Figure 37. Efficiency vs. Input Voltage for Load Current 0.1 A

NCV12711PSRGEVB

Standby Data

For all standby measurements, the dummy load 1 k Ω (R19) and Zener diode D5 were removed.

**Table 1. STANDBY INPUT POWER FOR $I_{out} = 1$ mA
WHEN THE IC IS SELF-SUPPLIED VIA LDO**

V_{IN} (V)	I_{IN} (mA)	P_{IN} (mW)	V_{OUT} (V)
4.5	14.7	66.5	13.1
15	6.8	102.6	13.4
25	4.6	114.5	14.1
45	4.0	179.0	15.4

**Table 2. STANDBY INPUT POWER FOR $I_{out} = 1$ mA
WHEN THE VCC PIN IS CONNECTED TO VIN PIN**

V_{IN} (V)	I_{IN} (mA)	P_{IN} (mW)	V_{OUT} (V)
4.5	14.9	67.3	13.0
15	7.0	104.3	13.4
25	4.6	115.0	15.4

**Table 3. STANDBY INPUT POWER FOR $I_{out} = 1$ mA
WHEN THE IC IS SELF-SUPPLIED VIA LDO**

V_{IN} (V)	I_{IN} (mA)	P_{IN} (mW)	V_{OUT} (V)
4.5	107.9	485.4	15.8
15	38.9	585.3	15.9
25	28.3	708.5	15.9
45	20.3	914.4	15.5

NCV12711PSRGEVB

Table 4. BILL OF MATERIALS

Designator (Main Board)	Qty	Description	Value	Tolerance	Footprint	Manufacturer	Manufacturer Part Number
C1	1	Ceramic capacitor	10 nF / 100 V	20%	0805	Generic	
C2	1	Ceramic capacitor	22 pF / 10 V	10%	0805	Generic	
C3	1	Ceramic capacitor	4.7 μF / 50 V	10%	1206	TDK	CGA5L3X7R1H475K160AB
C4	1	Ceramic capacitor	10 nF / 10 V	10%	0805	Generic	
C5, C13, C14	3	Electrolytic Capacitor	330 μF / 16 V	20%	TH	Rubycon	16ZLG330MEFC8X11.5
C6	1	Ceramic capacitor	22 nF / 10 V	10%	0805	Generic	
C7, C8	2	Ceramic capacitor	0.1 μF / 50 V	20%	0805	Generic	
C9	1	Electrolytic Capacitor	100 μF / 50 V	20%	TH	Rubycon	50ZL100MEFC8X11.5
C10, C11	2	Ceramic capacitor	2.2 μF / 100 V	20%	1210	Kemet	C1210C225M1RACTU
C12	1	Ceramic capacitor	0.47 μF / 50 V	20%	0805	Generic	
C15	1	Ceramic capacitor	4.7 nF / 16 V	10%	0805	Generic	
C16	1	Ceramic capacitor	330 pF / 16 V	10%	0805	Generic	
C17	1	Ceramic capacitor	470 pF / 100 V	10%	0805	Generic	
C18	1	Ceramic capacitor	3.3 nF / 630 V	10%	1206	Kemet	C1206C332KBRCTU
C19	1	Ceramic capacitor	470 pF / 50V	20%	0805	Generic	
D1	1	HV diode	1N4937	-	DO-41	onsemi	1N4937G
D2	1	power diode	FSV10120V	-	TO-277	onsemi	FSV10120V
D3	1	signal diode	MMSD914	-	SOD-123	onsemi	SMMSD914
D4	1	signal diode	BAV21	-	SOD-123	onsemi	
D5	1	Zener diode 15 V/3 W	1SMB5929BT3G	5%	SMB-2	onsemi	1SMB5929BT3G
J1a, J2a	2	Banana plug	-	-	-	multicomp	24.243.1
J1b, J2b	2	Banana plug	-	-	-	multicomp	24.243.2
L3	1	Inductor	1.5 μH	30%	-	Coilcraft	MSS1038-152NL
R1	1	Resistor	18 kΩ	1%	2512	Generic	
R2, R13	2	Resistor	40 mΩ	1%	2512	Vishay	WSL2512R0400FEA
R3	1	Resistor	845 Ω	1%	0805	Generic	
R4	1	Resistor	1.5 kΩ	1%	0805	Generic	
R5	1	Resistor	68 kΩ	1%	0805	Generic	
R6, R8, R17	3	Resistor	10 kΩ	1%	0805	Generic	
R7, R11	2	Resistor	133 kΩ	1%	0805	Generic	
R9	1	Resistor	38.3 kΩ	1%	0805	Generic	
R10, R16	2	Resistor	10 Ω	1%	0805	Generic	
R12, R14	2	Resistor	100 Ω / 0.5 W	1%	0805	Generic	
R15	1	Resistor	0 Ω	1%	0805	Generic	
R18, R21	2	Resistor	47 Ω	1%	0805	Generic	
R19	1	Resistor	1 kΩ	1%	2512	Generic	
R20	1	Resistor	2.2 Ω	1%	0805	Generic	
SW1	1	PCB Switch	-	-	-	multicomp	MCNDS-02V
T1	1	Transformer	ZA9654-AE	-	-	Coilcraft	ZA9654-AE
Q1	1	N-channel MOSFET	FDMS86103L	-	PQFN-8	onsemi	FDMS86103L
U1	1	PWM Controller	NCV12711	-	MSOP-10	onsemi	NCV12711A

NOTE: Ceramic capacitor are X7R type unless stated otherwise.

NOTE: TH = through hole part.

NOTE: All parts are lead free.

onsemi, **Onsemi**, and other names, marks, and brands are registered and/or common law trademarks of Semiconductor Components Industries, LLC dba "**onsemi**" or its affiliates and/or subsidiaries in the United States and/or other countries. **onsemi** owns the rights to a number of patents, trademarks, copyrights, trade secrets, and other intellectual property. A listing of **onsemi**'s product/patent coverage may be accessed at www.onsemi.com/site/pdf/Patent-Marking.pdf. **onsemi** is an Equal Opportunity/Affirmative Action Employer. This literature is subject to all applicable copyright laws and is not for resale in any manner.

The evaluation board/kit (research and development board/kit) (hereinafter the "board") is not a finished product and is not available for sale to consumers. The board is only intended for research, development, demonstration and evaluation purposes and will only be used in laboratory/development areas by persons with an engineering/technical training and familiar with the risks associated with handling electrical/mechanical components, systems and subsystems. This person assumes full responsibility/liability for proper and safe handling. Any other use, resale or redistribution for any other purpose is strictly prohibited.

THE BOARD IS PROVIDED BY ONSEMI TO YOU "AS IS" AND WITHOUT ANY REPRESENTATIONS OR WARRANTIES WHATSOEVER. WITHOUT LIMITING THE FOREGOING, ONSEMI (AND ITS LICENSORS/SUPPLIERS) HEREBY DISCLAIMS ANY AND ALL REPRESENTATIONS AND WARRANTIES IN RELATION TO THE BOARD, ANY MODIFICATIONS, OR THIS AGREEMENT, WHETHER EXPRESS, IMPLIED, STATUTORY OR OTHERWISE, INCLUDING WITHOUT LIMITATION ANY AND ALL REPRESENTATIONS AND WARRANTIES OF MERCHANTABILITY, FITNESS FOR A PARTICULAR PURPOSE, TITLE, NON-INFRINGEMENT, AND THOSE ARISING FROM A COURSE OF DEALING, TRADE USAGE, TRADE CUSTOM OR TRADE PRACTICE.

onsemi reserves the right to make changes without further notice to any board.

You are responsible for determining whether the board will be suitable for your intended use or application or will achieve your intended results. Prior to using or distributing any systems that have been evaluated, designed or tested using the board, you agree to test and validate your design to confirm the functionality for your application. Any technical, applications or design information or advice, quality characterization, reliability data or other services provided by **onsemi** shall not constitute any representation or warranty by **onsemi**, and no additional obligations or liabilities shall arise from **onsemi** having provided such information or services.

onsemi products including the boards are not designed, intended, or authorized for use in life support systems, or any FDA Class 3 medical devices or medical devices with a similar or equivalent classification in a foreign jurisdiction, or any devices intended for implantation in the human body. You agree to indemnify, defend and hold harmless **onsemi**, its directors, officers, employees, representatives, agents, subsidiaries, affiliates, distributors, and assigns, against any and all liabilities, losses, costs, damages, judgments, and expenses, arising out of any claim, demand, investigation, lawsuit, regulatory action or cause of action arising out of or associated with any unauthorized use, even if such claim alleges that **onsemi** was negligent regarding the design or manufacture of any products and/or the board.

This evaluation board/kit does not fall within the scope of the European Union directives regarding electromagnetic compatibility, restricted substances (RoHS), recycling (WEEE), FCC, CE or UL, and may not meet the technical requirements of these or other related directives.

FCC WARNING – This evaluation board/kit is intended for use for engineering development, demonstration, or evaluation purposes only and is not considered by **onsemi** to be a finished end product fit for general consumer use. It may generate, use, or radiate radio frequency energy and has not been tested for compliance with the limits of computing devices pursuant to part 15 of FCC rules, which are designed to provide reasonable protection against radio frequency interference. Operation of this equipment may cause interference with radio communications, in which case the user shall be responsible, at its expense, to take whatever measures may be required to correct this interference.

onsemi does not convey any license under its patent rights nor the rights of others.

LIMITATIONS OF LIABILITY: **onsemi** shall not be liable for any special, consequential, incidental, indirect or punitive damages, including, but not limited to the costs of requalification, delay, loss of profits or goodwill, arising out of or in connection with the board, even if **onsemi** is advised of the possibility of such damages. In no event shall **onsemi**'s aggregate liability from any obligation arising out of or in connection with the board, under any theory of liability, exceed the purchase price paid for the board, if any.

The board is provided to you subject to the license and other terms per **onsemi**'s standard terms and conditions of sale. For more information and documentation, please visit www.onsemi.com.

ADDITIONAL INFORMATION

TECHNICAL PUBLICATIONS:

Technical Library: www.onsemi.com/design/resources/technical-documentation
onsemi Website: www.onsemi.com

ONLINE SUPPORT: www.onsemi.com/support

For additional information, please contact your local Sales Representative at www.onsemi.com/support/sales