

QTP840-TB1-GEVK Evaluation Board User's Manual

Introduction

QTP840-TB1-GEVK is dual RGMII test board for Quantenna® Wi-Fi® module. QTP840-TB1-GEVK has Quantenna QT3840BC on board, which communicates with Wi-Fi chipset through PCIe interface via mPCIe connector.

Description

The QT3840BC chipset has two RGMII and one PCIe interface. On QTP840-TB1-GEVK test board, QT3840BC chipset communicates with Quantenna Wi-Fi module chipset through PCIe via mPCIe connector. The dual RGMII ports support 1 Gbps/100 Mbps/10 Mbps separately.

I/O Interfaces and Features

- Explicit and Implicit Digital Transmit Beamforming
- Advanced MIMO Features STBC and Channel State Aware Link Management for Sustained Link Robustness
- Two ARC-based Network Processors with Hardware Assist to Manage Multiple Simultaneous
- 802.11a/n/ac Connections
- DSP Engine to Hardware Accelerate Aggregation, De-aggregation, and Packet Re-ordering
- MU-MIMO Support
- SuperDFS Support
- Expanded Support for 128 Users
- LDPC Support
- Works with Quantenna 4x4 5 GHz RFIC (QT2518B)
- DDR2/DDR3 Memory Support
- PCIe Gen2.0 with Embedded DMA
- Standards: 802.11ac/n/a
802.11i (WEP, WPA/WPA2, RADIUS)
802.11d
802.11e (WMM, WMM-PS)
802.11w
802.11h
802.11k
- Operating Frequencies: 4.9–5.85 GHz
- Maximum Data Rate (per Stream) – Rates are for 256 QAM Operation
 - ◆ 80 MHz: 1.7 Gbps (433.33 Mbps)
 - ◆ 40 MHz: 800 Mbps (200 Mbps)
 - ◆ 20 MHz: 346.8 Mbps (86.7 Mbps)



ON Semiconductor®

www.onsemi.com

EVAl BOARD USER'S MANUAL

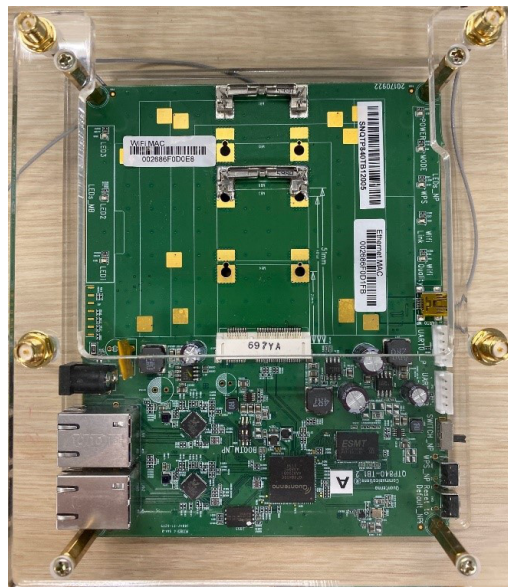

Figure 1. QTP840-TB1-GEVK Photo

EVBUM2689/D

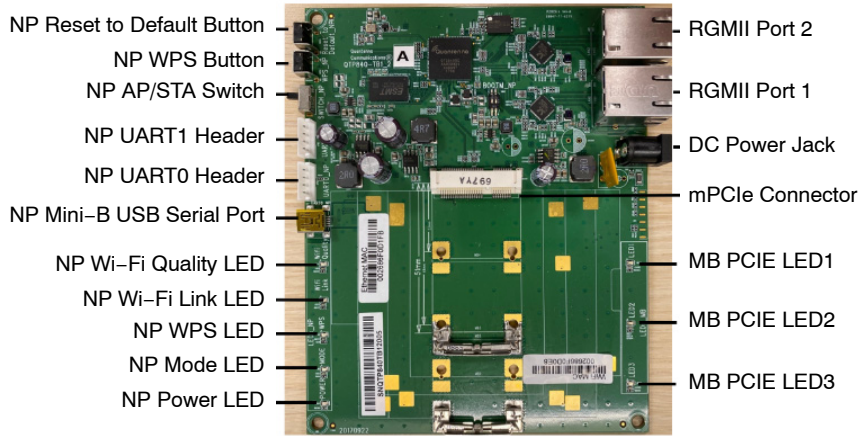

Figure 2. QTP840-TB1-GEVK Description

APPLICATIONS INFORMATION

Power Configuration

QTP840-TB1-GEVK is designed to be powered externally. The external power supply should be 12 V DC. When the board is powered on, the power LED will be steady green.

Reset to Default Button (NP)

Reserved (Reset to default Button).

WPS Button (NP)

Reserved (WPS Button).

AP/STA Switch (NP)

Reserved (AP/STA Switch)

RGMII Port 1/2

RGMII supports 1 Gbps/100 Mbps/10 Mbps UTP speed.

Mini-B USB Serial Port (NP)

The Serial port is mainly used for debug purpose.

Table 1. SERIAL PORT SETTING

Baud Rate	115200
Data	8 bit
Parity	None
Stop	1 bit
Flow Control	None

Boot Mode Switch

Boot mode switch controls serial port mode.

Table 2. BOOT MODE SWITCH DEFINITION

State	Definition
00	bootm
10	SPI-0 (Default)

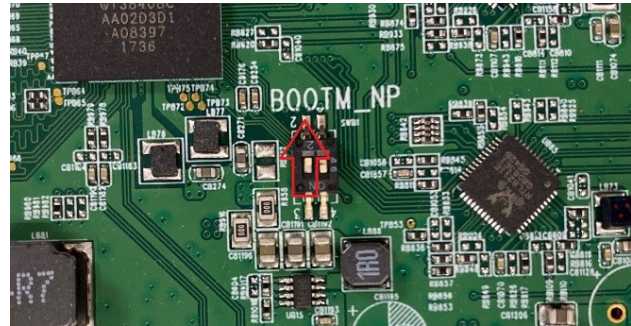

Figure 3. Default Setting (SPI-0)

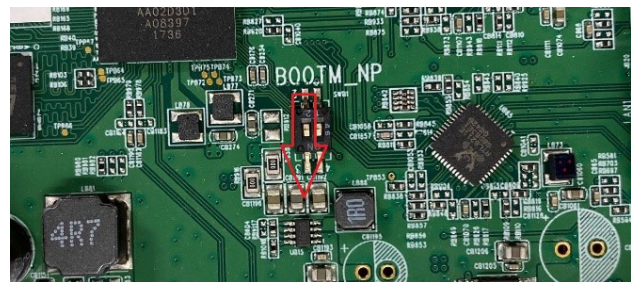

Figure 4. Bootm Setting

BOARD POWER UP

LED Indication When QTP840-TB1-GEVK Powers Up

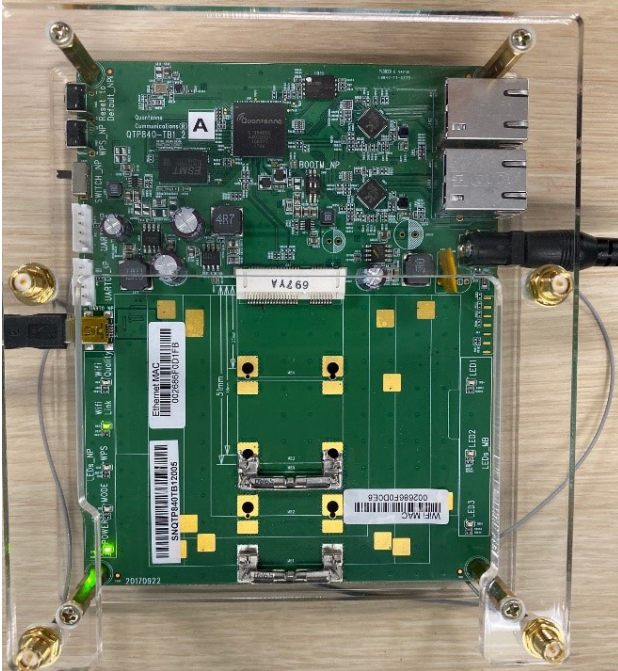

Figure 5. LED Indication When QTP840-TB1-GEVK Powers Up

Console Display When QTP840-TB1-GEVK Successfully Boots Up

When QTP840-TB1-GEVK successfully boots up, it will show “quantenna #”.

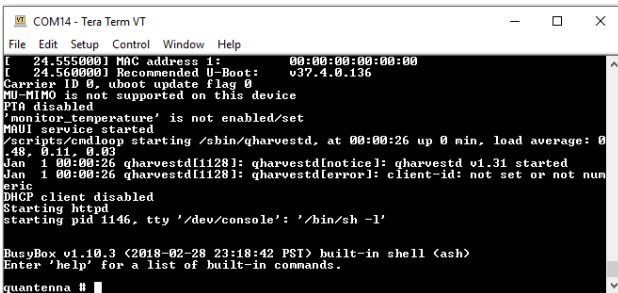

Figure 6. QTP840-TB1-GEVK Successfully Boots Up

Web GUI

QH840-5S7-GEVK default IP address is 192.168.1.200.

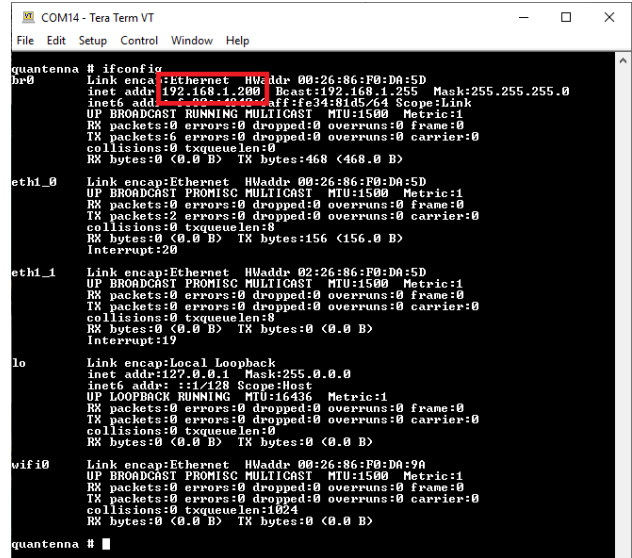
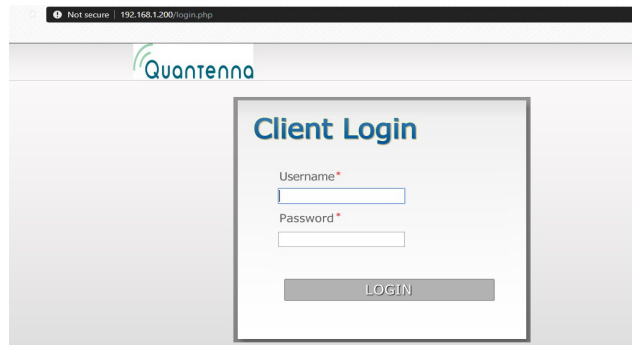

Figure 7. Default IP Address



Web GUI username: super
password: super

Figure 8. Web GUI Username and Password

Telnet

QTP840–TB1–GEVK could also be accessed through telnet. Use board IP address and the login username is “root”.

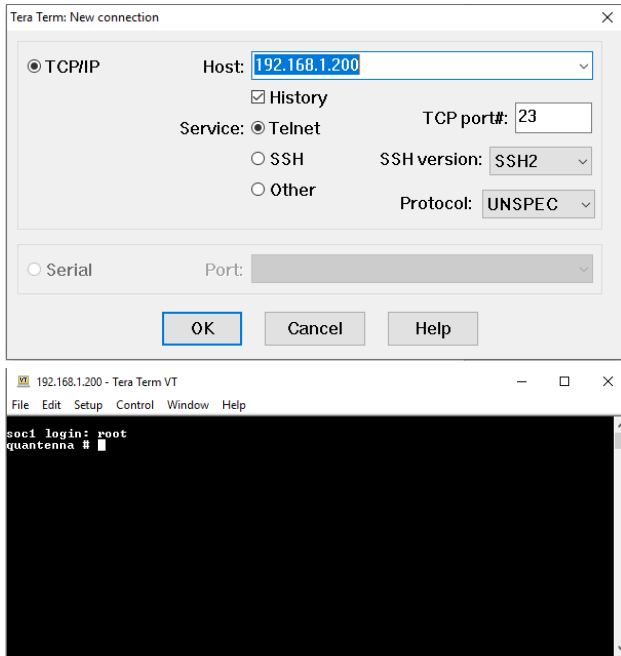

Figure 9. Access Through Telnet

Quantenna is a registered trademark of Semiconductor Components Industries, LLC (SCILLC) or its subsidiaries in the United States and/or other countries.

Wi-Fi is a registered trademarks of Wi-Fi Alliance.

onsemi, **Onsemi**, and other names, marks, and brands are registered and/or common law trademarks of Semiconductor Components Industries, LLC dba "**onsemi**" or its affiliates and/or subsidiaries in the United States and/or other countries. **onsemi** owns the rights to a number of patents, trademarks, copyrights, trade secrets, and other intellectual property. A listing of **onsemi**'s product/patent coverage may be accessed at www.onsemi.com/site/pdf/Patent-Marking.pdf. **onsemi** is an Equal Opportunity/Affirmative Action Employer. This literature is subject to all applicable copyright laws and is not for resale in any manner.

The evaluation board/kit (research and development board/kit) (hereinafter the "board") is not a finished product and is not available for sale to consumers. The board is only intended for research, development, demonstration and evaluation purposes and will only be used in laboratory/development areas by persons with an engineering/technical training and familiar with the risks associated with handling electrical/mechanical components, systems and subsystems. This person assumes full responsibility/liability for proper and safe handling. Any other use, resale or redistribution for any other purpose is strictly prohibited.

THE BOARD IS PROVIDED BY ONSEMI TO YOU "AS IS" AND WITHOUT ANY REPRESENTATIONS OR WARRANTIES WHATSOEVER. WITHOUT LIMITING THE FOREGOING, ONSEMI (AND ITS LICENSORS/SUPPLIERS) HEREBY DISCLAIMS ANY AND ALL REPRESENTATIONS AND WARRANTIES IN RELATION TO THE BOARD, ANY MODIFICATIONS, OR THIS AGREEMENT, WHETHER EXPRESS, IMPLIED, STATUTORY OR OTHERWISE, INCLUDING WITHOUT LIMITATION ANY AND ALL REPRESENTATIONS AND WARRANTIES OF MERCHANTABILITY, FITNESS FOR A PARTICULAR PURPOSE, TITLE, NON-INFRINGEMENT, AND THOSE ARISING FROM A COURSE OF DEALING, TRADE USAGE, TRADE CUSTOM OR TRADE PRACTICE.

onsemi reserves the right to make changes without further notice to any board.

You are responsible for determining whether the board will be suitable for your intended use or application or will achieve your intended results. Prior to using or distributing any systems that have been evaluated, designed or tested using the board, you agree to test and validate your design to confirm the functionality for your application. Any technical, applications or design information or advice, quality characterization, reliability data or other services provided by **onsemi** shall not constitute any representation or warranty by **onsemi**, and no additional obligations or liabilities shall arise from **onsemi** having provided such information or services.

onsemi products including the boards are not designed, intended, or authorized for use in life support systems, or any FDA Class 3 medical devices or medical devices with a similar or equivalent classification in a foreign jurisdiction, or any devices intended for implantation in the human body. You agree to indemnify, defend and hold harmless **onsemi**, its directors, officers, employees, representatives, agents, subsidiaries, affiliates, distributors, and assigns, against any and all liabilities, losses, costs, damages, judgments, and expenses, arising out of any claim, demand, investigation, lawsuit, regulatory action or cause of action arising out of or associated with any unauthorized use, even if such claim alleges that **onsemi** was negligent regarding the design or manufacture of any products and/or the board.

This evaluation board/kit does not fall within the scope of the European Union directives regarding electromagnetic compatibility, restricted substances (RoHS), recycling (WEEE), FCC, CE or UL, and may not meet the technical requirements of these or other related directives.

FCC WARNING – This evaluation board/kit is intended for use for engineering development, demonstration, or evaluation purposes only and is not considered by **onsemi** to be a finished end product fit for general consumer use. It may generate, use, or radiate radio frequency energy and has not been tested for compliance with the limits of computing devices pursuant to part 15 of FCC rules, which are designed to provide reasonable protection against radio frequency interference. Operation of this equipment may cause interference with radio communications, in which case the user shall be responsible, at its expense, to take whatever measures may be required to correct this interference.

onsemi does not convey any license under its patent rights nor the rights of others.

LIMITATIONS OF LIABILITY: **onsemi** shall not be liable for any special, consequential, incidental, indirect or punitive damages, including, but not limited to the costs of requalification, delay, loss of profits or goodwill, arising out of or in connection with the board, even if **onsemi** is advised of the possibility of such damages. In no event shall **onsemi**'s aggregate liability from any obligation arising out of or in connection with the board, under any theory of liability, exceed the purchase price paid for the board, if any.

The board is provided to you subject to the license and other terms per **onsemi**'s standard terms and conditions of sale. For more information and documentation, please visit www.onsemi.com.

ADDITIONAL INFORMATION

TECHNICAL PUBLICATIONS:

Technical Library: www.onsemi.com/design/resources/technical-documentation
onsemi Website: www.onsemi.com

ONLINE SUPPORT: www.onsemi.com/support

For additional information, please contact your local Sales Representative at www.onsemi.com/support/sales