

QORVO

SiC JFET Division

Is Now Part of

onsemi™

To learn more about onsemi™, please visit our website at
www.onsemi.com

onsemi and **onsemi** and other names, marks, and brands are registered and/or common law trademarks of Semiconductor Components Industries, LLC dba "**onsemi**" or its affiliates and/or subsidiaries in the United States and/or other countries. **onsemi** owns the rights to a number of patents, trademarks, copyrights, trade secrets, and other intellectual property. A listing of **onsemi** product/patent coverage may be accessed at www.onsemi.com/site/pdf/Patent-Marking.pdf. **onsemi** reserves the right to make changes at any time to any products or information herein, without notice. The information herein is provided "as-is" and **onsemi** makes no warranty, representation or guarantee regarding the accuracy of the information, product features, availability, functionality, or suitability of its products for any particular purpose, nor does **onsemi** assume any liability arising out of the application or use of any product or circuit, and specifically disclaims any and all liability, including without limitation special, consequential or incidental damages. Buyer is responsible for its products and applications using **onsemi** products, including compliance with all laws, regulations and safety requirements or standards, regardless of any support or applications information provided by **onsemi**. "Typical" parameters which may be provided in **onsemi** data sheets and/or specifications can and do vary in different applications and actual performance may vary over time. All operating parameters, including "Typicals" must be validated for each customer application by customer's technical experts. **onsemi** does not convey any license under any of its intellectual property rights nor the rights of others. **onsemi** products are not designed, intended, or authorized for use as a critical component in life support systems or any FDA Class 3 medical devices or medical devices with a same or similar classification in a foreign jurisdiction or any devices intended for implantation in the human body. Should Buyer purchase or use **onsemi** products for any such unintended or unauthorized application, Buyer shall indemnify and hold **onsemi** and its officers, employees, subsidiaries, affiliates, and distributors harmless against all claims, costs, damages, and expenses, and reasonable attorney fees arising out of, directly or indirectly, any claim of personal injury or death associated with such unintended or unauthorized use, even if such claim alleges that **onsemi** was negligent regarding the design or manufacture of the part. **onsemi** is an Equal Opportunity/Affirmative Action Employer. This literature is subject to all applicable copyright laws and is not for resale in any manner. Other names and brands may be claimed as the property of others.

Silicon Carbide (SiC) Cascode JFET - EliteSiC, Power N-Channel, TO-247-4L, 750V, 5.9 mohm

Rev. C, January 2025

DATASHEET

UJ4SC075006K4S

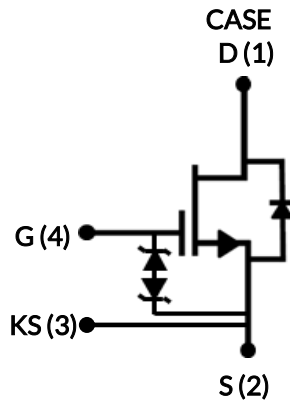
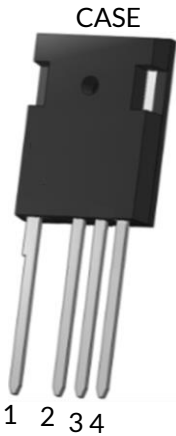

Description

The UJ4SC075006K4S is a 750V, 5.9mΩ G4 SiC FET. It is based on a unique ‘cascode’ circuit configuration, in which a normally-on SiC JFET is co-packaged with a Si MOSFET to produce a normally-off SiC FET device. The device’s standard gate-drive characteristics allows for a true “drop-in replacement” to Si IGBTs, Si FETs, SiC MOSFETs or Si superjunction devices. Available in the TO-247-4L package, this device exhibits ultra-low gate charge and exceptional reverse recovery characteristics, making it ideal for switching inductive loads and any application requiring standard gate drive.

Features

- ◆ On-resistance $R_{DS(on)}$: 5.9mΩ (typ)
- ◆ Operating temperature: 175°C (max)
- ◆ Excellent reverse recovery: Q_{rr} = 440nC
- ◆ Low body diode V_{FSD} : 1.03V
- ◆ Low gate charge: Q_G = 164nC
- ◆ Threshold voltage $V_{G(th)}$: 4.7V (typ) allowing 0 to 15V drive
- ◆ Low intrinsic capacitance
- ◆ ESD protected, HBM class 2
- ◆ TO-247-4L package for faster switching, clean gate waveforms

Typical applications

- ◆ EV charging
- ◆ PV inverters
- ◆ Switch mode power supplies
- ◆ Power factor correction modules
- ◆ Motor drives
- ◆ Induction heating

Part Number	Package	Marking
UJ4SC075006K4S	TO-247-4L	UJ4SC075006K4S



Maximum Ratings

Parameter	Symbol	Test Conditions	Value	Units
Drain-source voltage	V_{DS}		750	V
Gate-source voltage	V_{GS}	DC	-20 to +20	V
		AC (f > 1Hz)	-25 to +25	V
Continuous drain current ¹	I_D	$T_C < 125^\circ\text{C}$	120	A
Pulsed drain current ²	I_{DM}	$T_C = 25^\circ\text{C}$	588	A
Single pulsed avalanche energy ³	E_{AS}	L=15mH, $I_{AS} = 6.5\text{A}$	316	mJ
Short circuit withstand time ⁴	t_{SC}	$V_{DS} = 400\text{V}$, $T_{J(\text{START})} = 175^\circ\text{C}$	5	μs
SiC FET dv/dt ruggedness	dv/dt	$V_{DS} \leq 500\text{V}$	100	V/ns
Power dissipation	P_{tot}	$T_C = 25^\circ\text{C}$	714	W
Maximum junction temperature	$T_{J,max}$		175	$^\circ\text{C}$
Operating and storage temperature	T_J, T_{STG}		-55 to 175	$^\circ\text{C}$
Max. lead temperature for soldering, 1/8" from case for 5 seconds	T_L		250	$^\circ\text{C}$

1. Limited by bondwires

2. Pulse width t_p limited by $T_{J,max}$

3. Starting $T_J = 25^\circ\text{C}$

4. Short circuit current is independent of the gate voltage $V_{GS} > 12\text{V}$

Thermal Characteristics

Parameter	Symbol	Test Conditions	Value			Units
			Min	Typ	Max	
Thermal resistance, junction-to-case	$R_{\theta JC}$			0.16	0.21	$^\circ\text{C/W}$

Electrical Characteristics ($T_J = +25^\circ\text{C}$ unless otherwise specified)

Typical Performance - Static

Parameter	Symbol	Test Conditions	Value			Units
			Min	Typ	Max	
Drain-source breakdown voltage	BV_{DS}	$V_{GS}=0V, I_D=1mA$	750			V
Total drain leakage current	I_{DSS}	$V_{DS}=750V,$ $V_{GS}=0V, T_J=25^\circ\text{C}$		6	130	μA
		$V_{DS}=750V,$ $V_{GS}=0V, T_J=175^\circ\text{C}$		45		
Total gate leakage current	I_{GSS}	$V_{DS}=0V, T_J=25^\circ\text{C},$ $V_{GS}=-20V / +20V$		6	± 20	μA
Drain-source on-resistance	$R_{DS(on)}$	$V_{GS}=12V, I_D=80A,$ $T_J=25^\circ\text{C}$		5.9	7.4	m Ω
		$V_{GS}=12V, I_D=80A,$ $T_J=125^\circ\text{C}$		9.8		
		$V_{GS}=12V, I_D=80A,$ $T_J=175^\circ\text{C}$		12.9		
Gate threshold voltage	$V_{G(th)}$	$V_{DS}=5V, I_D=10mA$	4	4.7	6	V
Gate resistance	R_G	f=1MHz, open drain		0.8	1.5	Ω

Typical Performance - Reverse Diode

Parameter	Symbol	Test Conditions	Value			Units
			Min	Typ	Max	
Diode continuous forward current ¹	I_S	$T_C < 125^\circ\text{C}$			120	A
Diode pulse current ²	$I_{S,pulse}$	$T_C=25^\circ\text{C}$			588	A
Forward voltage	V_{FSD}	$V_{GS}=0V, I_F=50A,$ $T_J=25^\circ\text{C}$		1.03	1.16	V
		$V_{GS}=0V, I_F=50A,$ $T_J=175^\circ\text{C}$		1.06		
Reverse recovery charge	Q_{rr}	$V_R=400V, I_F=80A,$ $V_{GS}=0V, R_{G,EXT}=5\Omega$ $di/dt=2800A/\mu\text{s},$ $T_J=25^\circ\text{C}$		440		nC
Reverse recovery time	t_{rr}	$T_J=25^\circ\text{C}$		31		ns
Reverse recovery charge	Q_{rr}	$V_R=400V, I_F=80A,$ $V_{GS}=0V, R_{G,EXT}=5\Omega$ $di/dt=2800A/\mu\text{s},$ $T_J=150^\circ\text{C}$		525		nC
Reverse recovery time	t_{rr}	$T_J=150^\circ\text{C}$		37		ns

Typical Performance - Dynamic

Parameter	Symbol	Test Conditions	Value			Units
			Min	Typ	Max	
Input capacitance	C_{iss}	$V_{DS}=400V, V_{GS}=0V$ $f=100kHz$		8374		pF
Output capacitance	C_{oss}			362		
Reverse transfer capacitance	C_{rss}			4		
Effective output capacitance, energy related	$C_{oss(er)}$	$V_{DS}=0V$ to $400V$, $V_{GS}=0V$		475		pF
Effective output capacitance, time related	$C_{oss(tr)}$	$V_{DS}=0V$ to $400V$, $V_{GS}=0V$		950		pF
C_{OSS} stored energy	E_{oss}	$V_{DS}=400V, V_{GS}=0V$		38		μJ
Total gate charge	Q_G	$V_{DS}=400V, I_D=80A$, $V_{GS} = -0V$ to $15V$		164		nC
Gate-drain charge	Q_{GD}			24		
Gate-source charge	Q_{GS}			46		
Turn-on delay time	$t_{d(on)}$	Notes 5 and 6, $V_{DS}=400V, I_D=80A$, Gate Driver = $0V$ to $+15V$, Turn-on $R_{G,EXT}=1.5\Omega$, Turn-off $R_{G,EXT}=5\Omega$, inductive Load, FWD: same device with $V_{GS} = 0V$ and $R_G = 5\Omega$, RC snubber: $R_S=5\Omega$ and $C_S=680pF$, $T_J=25^\circ C$		37		ns
Rise time	t_r			40		
Turn-off delay time	$t_{d(off)}$			110		
Fall time	t_f			13		
Turn-on energy including R_S energy	E_{ON}			514		
Turn-off energy including R_S energy	E_{OFF}		170		μJ	
Total switching energy	E_{TOTAL}		684			
Snubber R_S energy during turn-on	E_{RS_ON}		9.6			
Snubber R_S energy during turn-off	E_{RS_OFF}		50			
Turn-on delay time	$t_{d(on)}$	Notes 5 and 6, $V_{DS}=400V, I_D=80A$, Gate Driver = $0V$ to $+15V$, Turn-on $R_{G,EXT}=1.5\Omega$, Turn-off $R_{G,EXT}=5\Omega$, inductive Load, FWD: same device with $V_{GS} = 0V$ and $R_G = 5\Omega$, RC snubber: $R_S=5\Omega$ and $C_S=680pF$, $T_J=150^\circ C$		36		ns
Rise time	t_r			44		
Turn-off delay time	$t_{d(off)}$			121		
Fall time	t_f			16		
Turn-on energy including R_S energy	E_{ON}			640		
Turn-off energy including R_S energy	E_{OFF}		189		μJ	
Total switching energy	E_{TOTAL}		829			
Snubber R_S energy during turn-on	E_{RS_ON}		9			
Snubber R_S energy during turn-off	E_{RS_OFF}		51			

5. Measured with the switching test circuit in Figure 29.

6. In this datasheet, all the switching energies (turn-on energy, turn-off energy and total energy) presented in the tables and Figures include the device RC snubber energy losses.

Typical Performance Diagrams

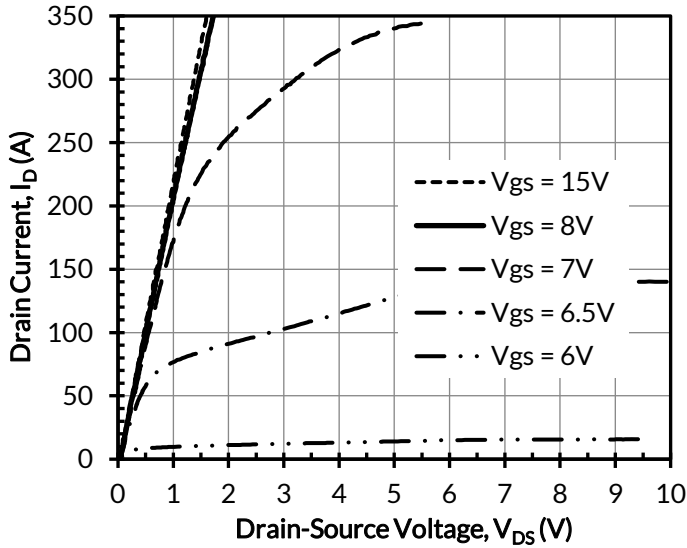

Figure 1. Typical output characteristics at $T_J = -55^\circ\text{C}$, $t_p < 250\mu\text{s}$

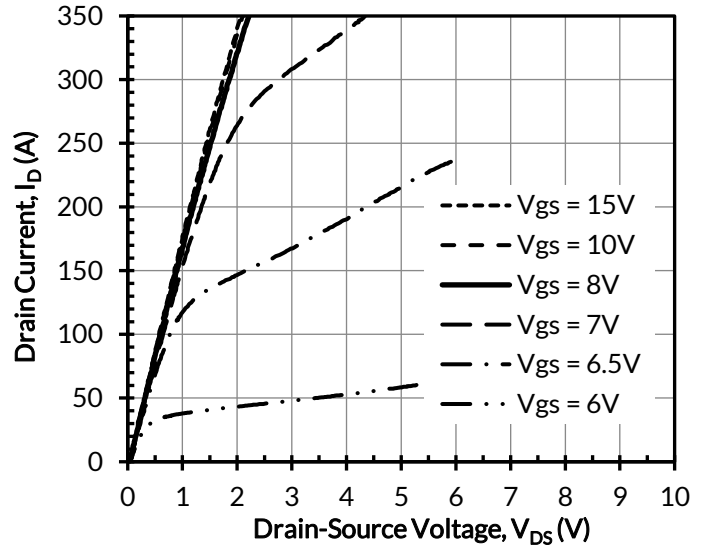

Figure 2. Typical output characteristics at $T_J = 25^\circ\text{C}$, $t_p < 250\mu\text{s}$

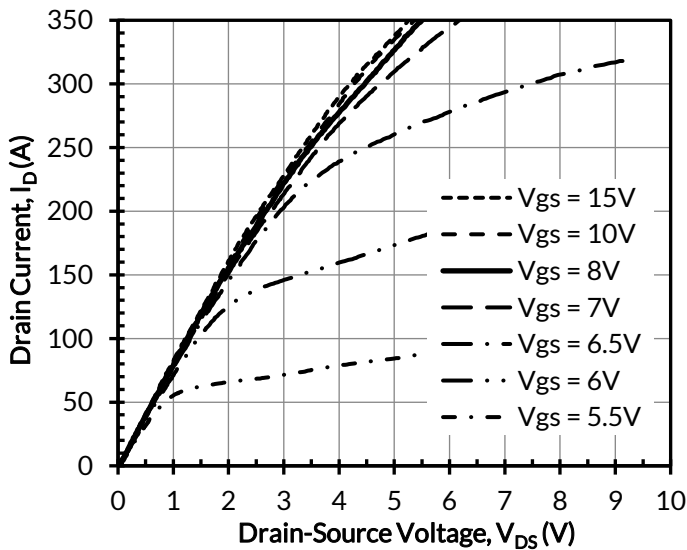

Figure 3. Typical output characteristics at $T_J = 175^\circ\text{C}$, $t_p < 250\mu\text{s}$

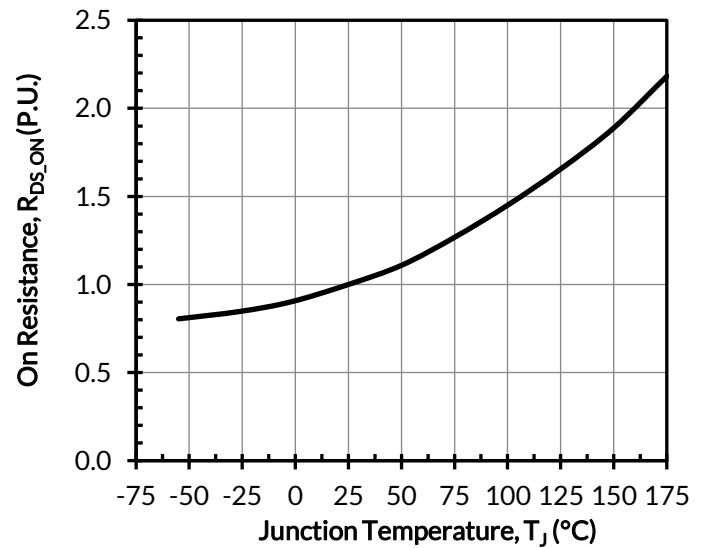

Figure 4. Normalized on-resistance vs. temperature at $V_{GS} = 12\text{V}$ and $I_D = 80\text{A}$

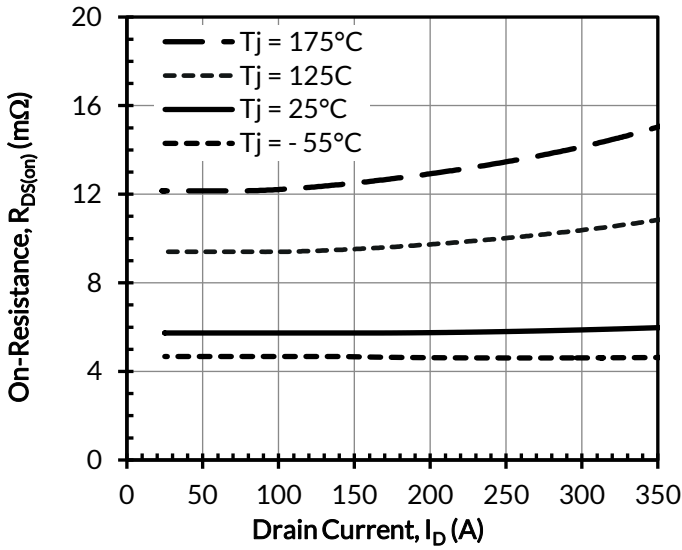

Figure 5. Typical drain-source on-resistances at $V_{GS} = 12V$

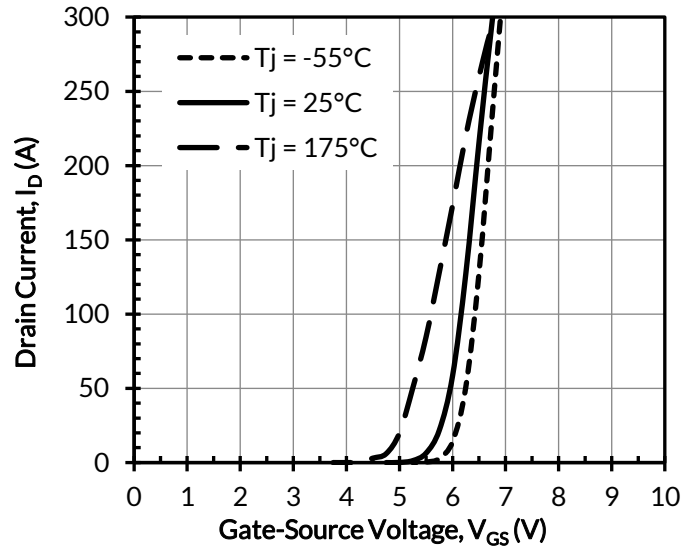

Figure 6. Typical transfer characteristics at $V_{DS} = 5V$

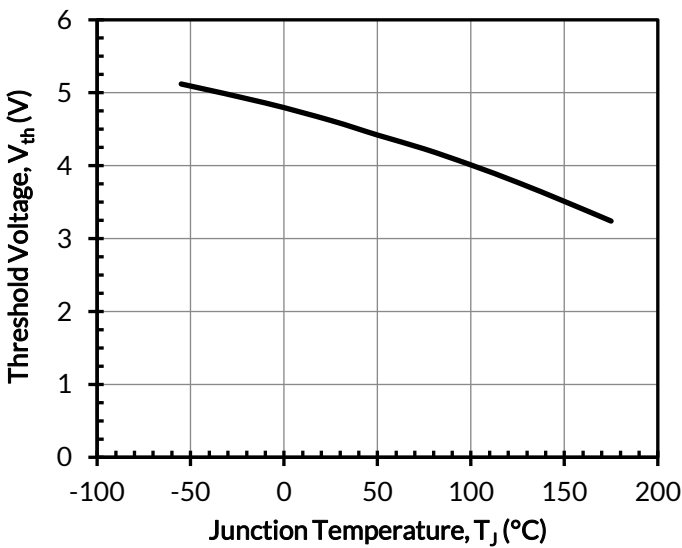

Figure 7. Threshold voltage vs. junction temperature at $V_{DS} = 5V$ and $I_D = 10mA$

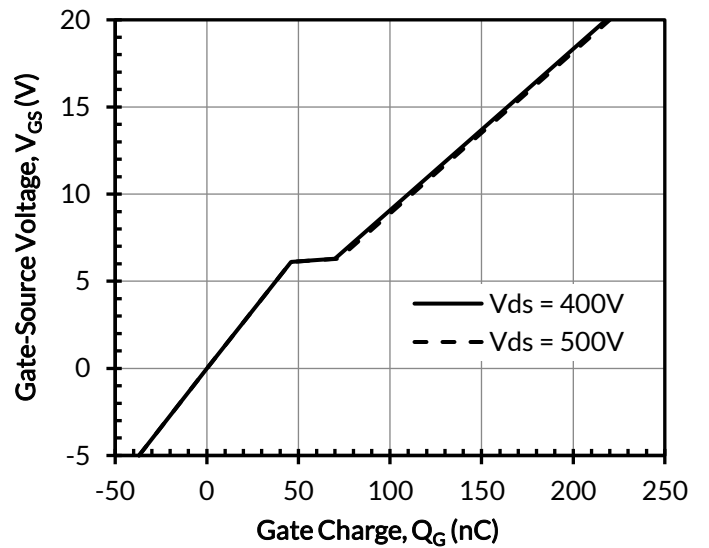

Figure 8. Typical gate charge at $I_D = 80A$

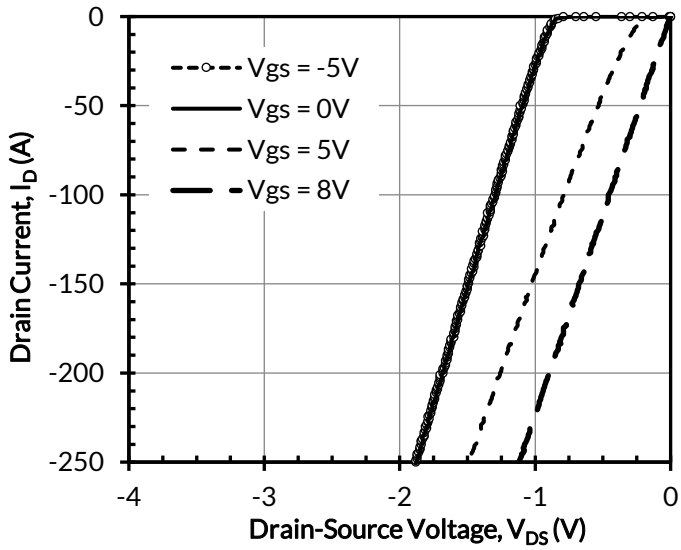

Figure 9. 3rd quadrant characteristics at $T_j = -55^\circ\text{C}$

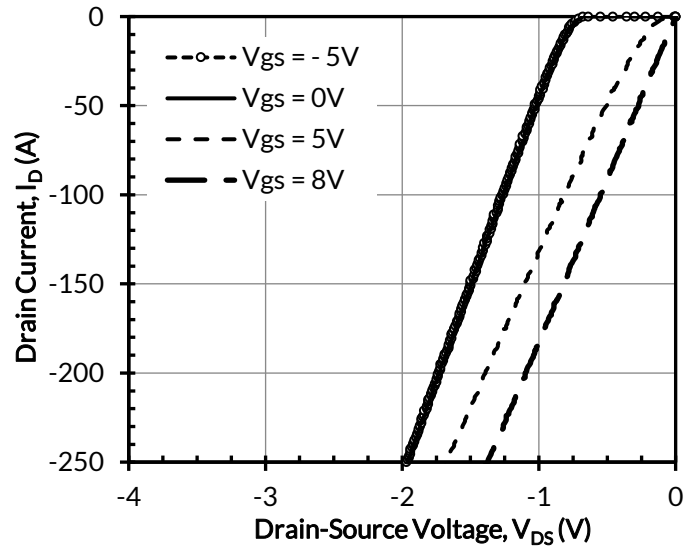

Figure 10. 3rd quadrant characteristics at $T_j = 25^\circ\text{C}$

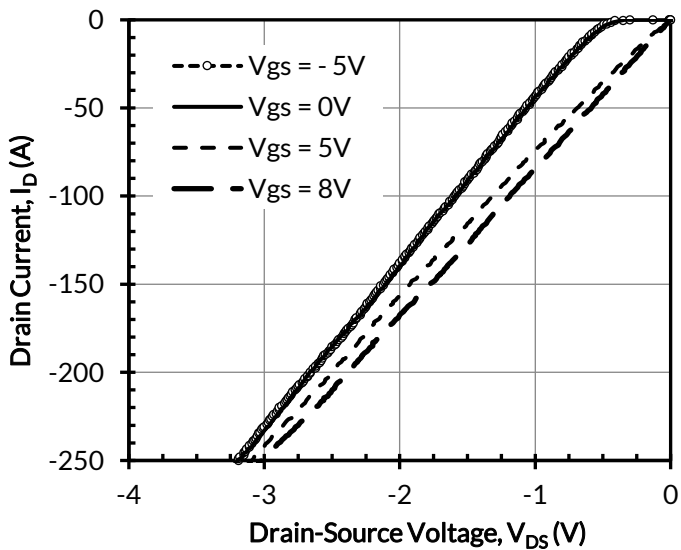

Figure 11. 3rd quadrant characteristics at $T_j = 175^\circ\text{C}$

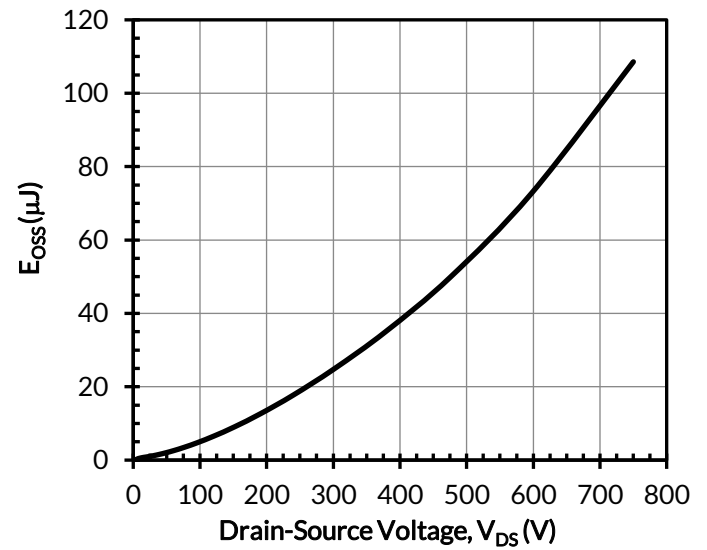

Figure 12. Typical stored energy in C_{OSS} at $V_{GS} = 0\text{V}$

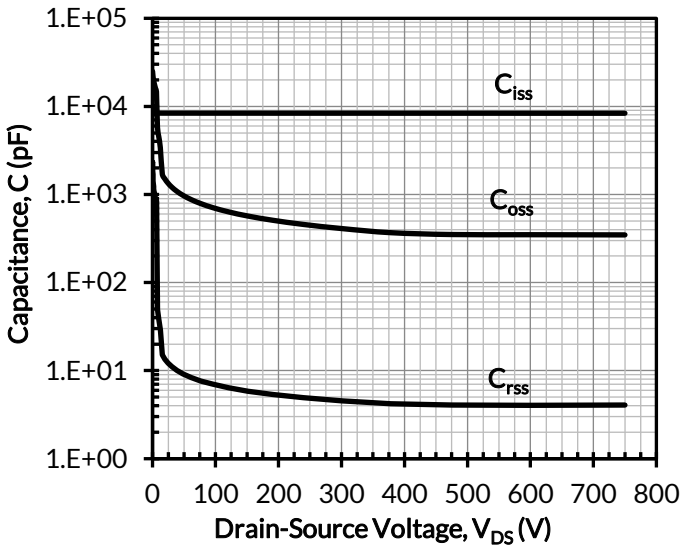

Figure 13. Typical capacitances at $f = 100\text{kHz}$ and $V_{GS} = 0\text{V}$

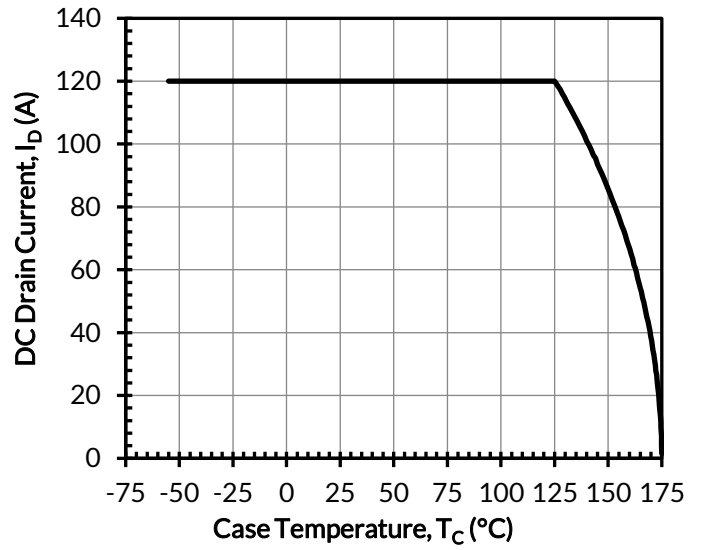

Figure 14. DC drain current derating

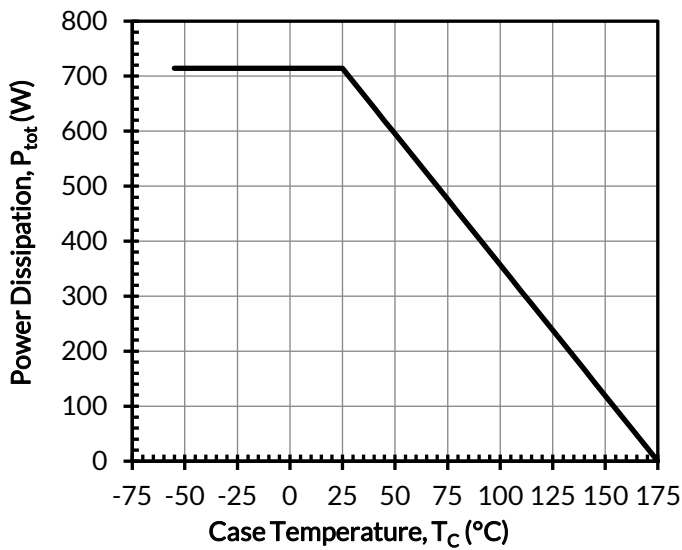

Figure 15. Total power dissipation

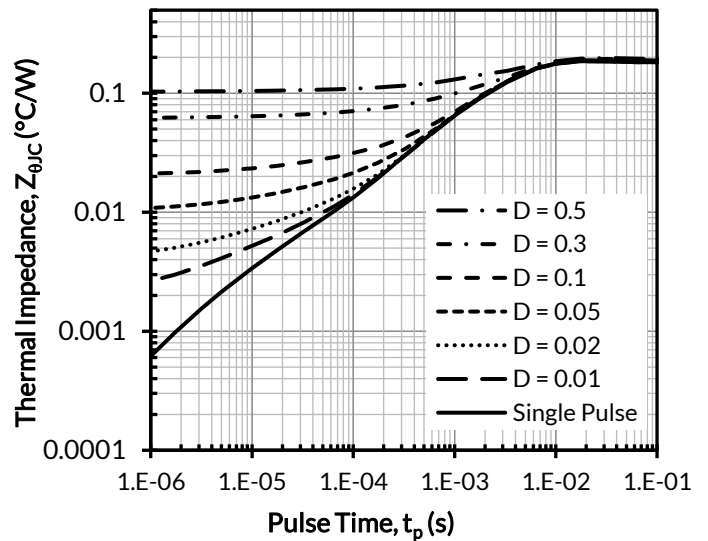

Figure 16. Maximum transient thermal impedance

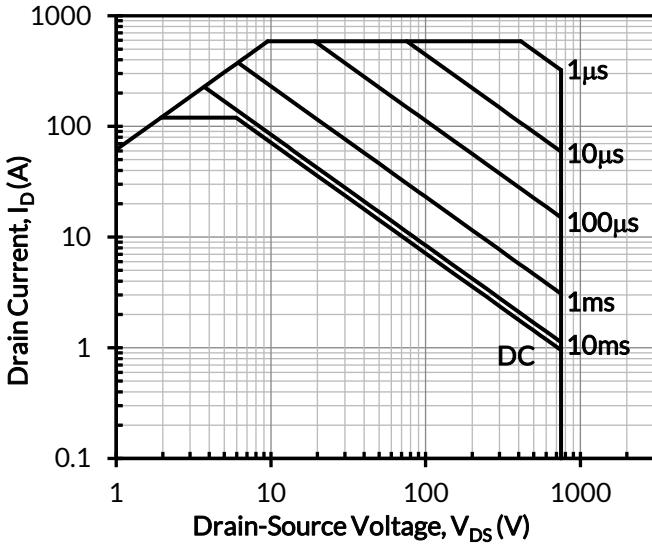

Figure 17. Safe operation area at $T_C = 25^\circ\text{C}$, $D = 0$, Parameter t_p

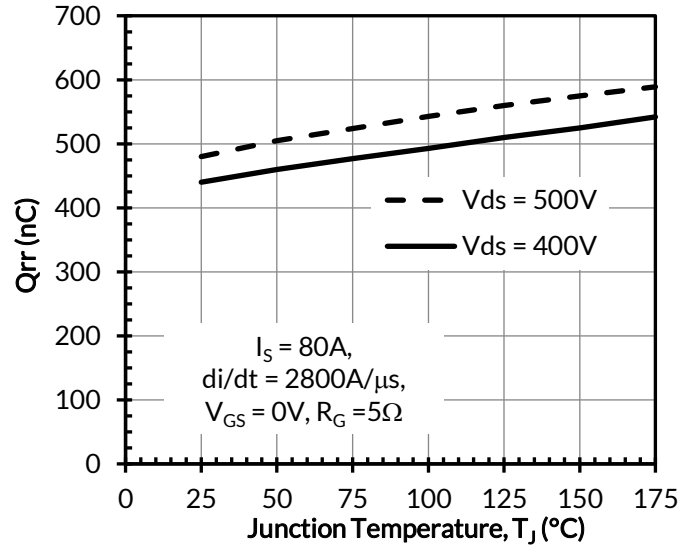

Figure 18. Reverse recovery charge Q_{rr} vs. junction temperature

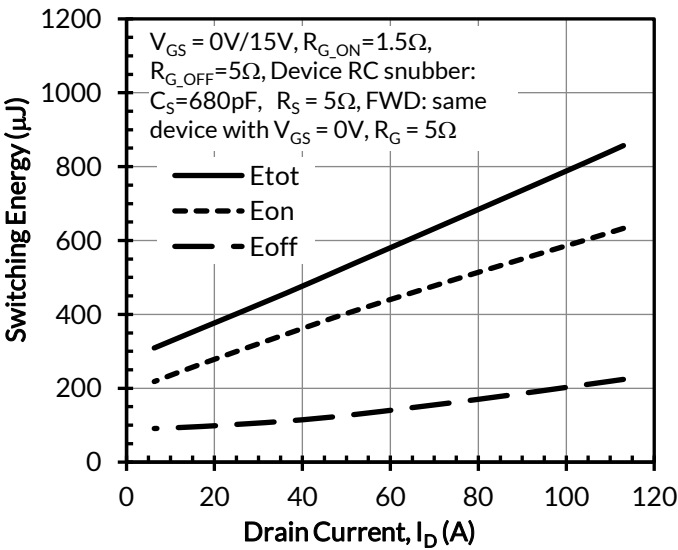

Figure 19. Clamped inductive switching energy vs. drain current at $V_{DS} = 400\text{V}$ and $T_J = 25^\circ\text{C}$

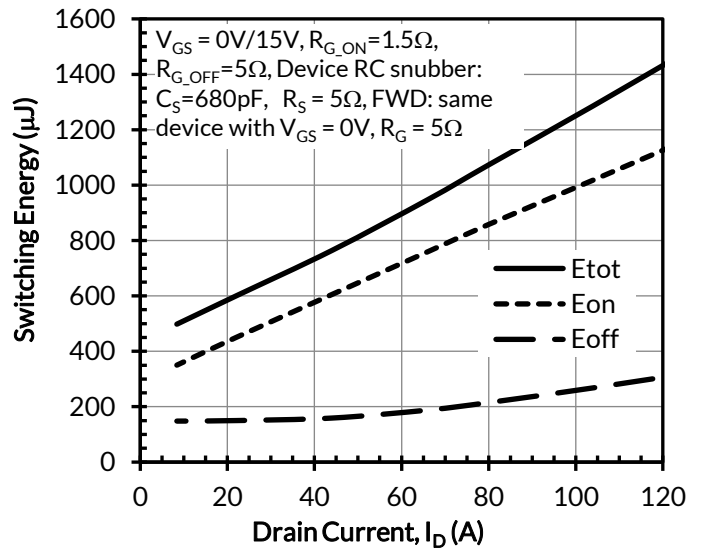

Figure 20. Clamped inductive switching energy vs. drain current at $V_{DS} = 500\text{V}$ and $T_J = 25^\circ\text{C}$

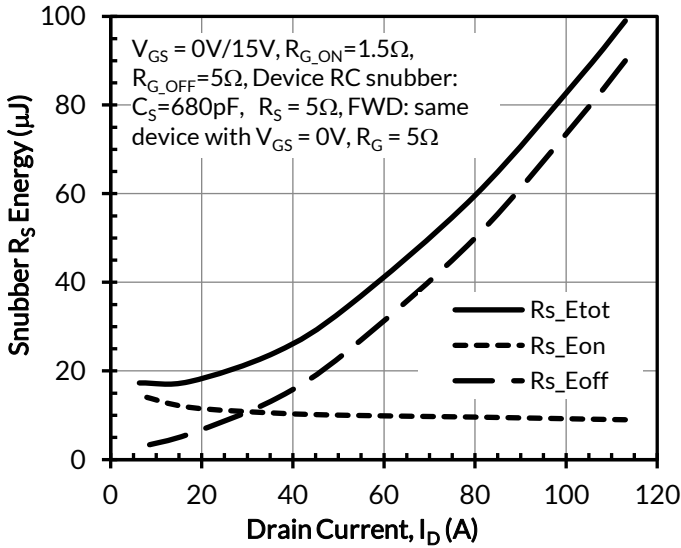

Figure 21. RC snubber energy loss vs. drain current at $V_{DS} = 400V$ and $T_J = 25^\circ C$

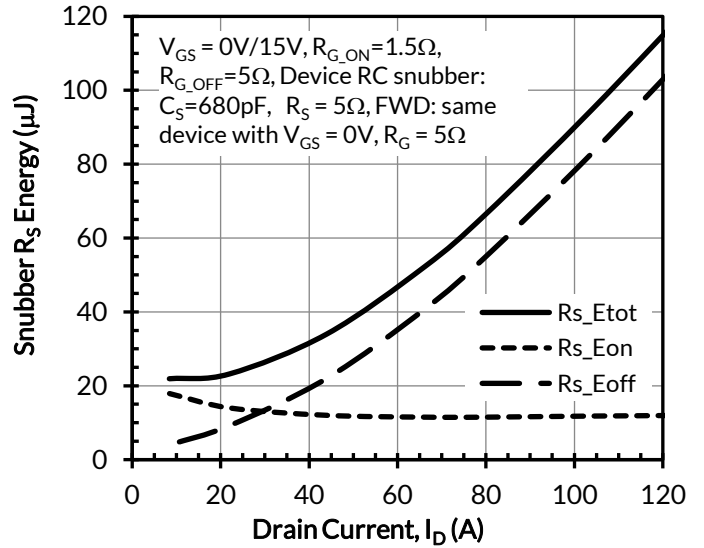

Figure 22. RC snubber energy losses vs. drain current at $V_{DS} = 500V$ and $T_J = 25^\circ C$

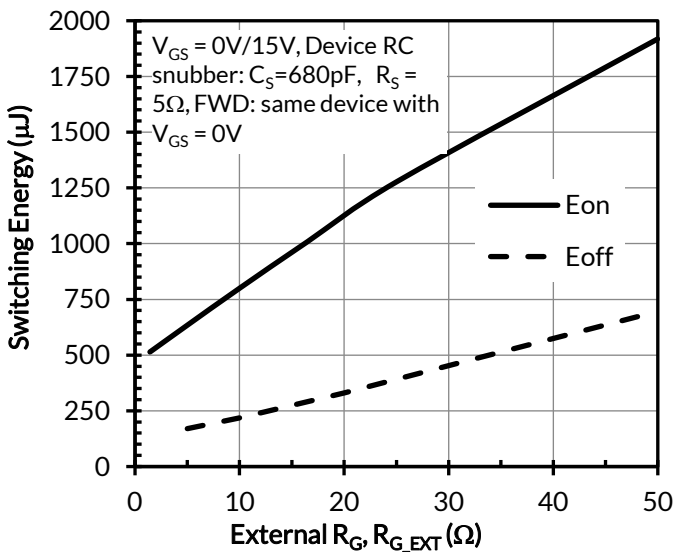

Figure 23. Clamped inductive switching energies vs. $R_{G,EXT}$ at $V_{DS} = 400V$, $I_D = 80A$, and $T_J = 25^\circ C$

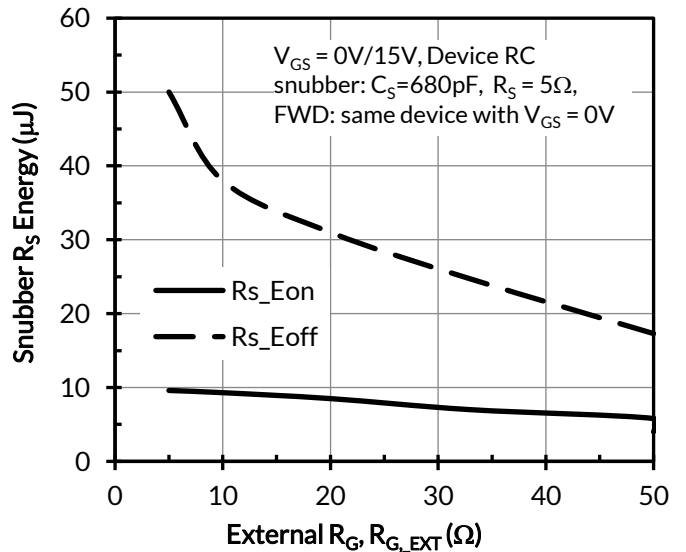

Figure 24. RC snubber energy losses vs. $R_{G,EXT}$ at $V_{DS} = 400V$, $I_D = 80A$, and $T_J = 25^\circ C$

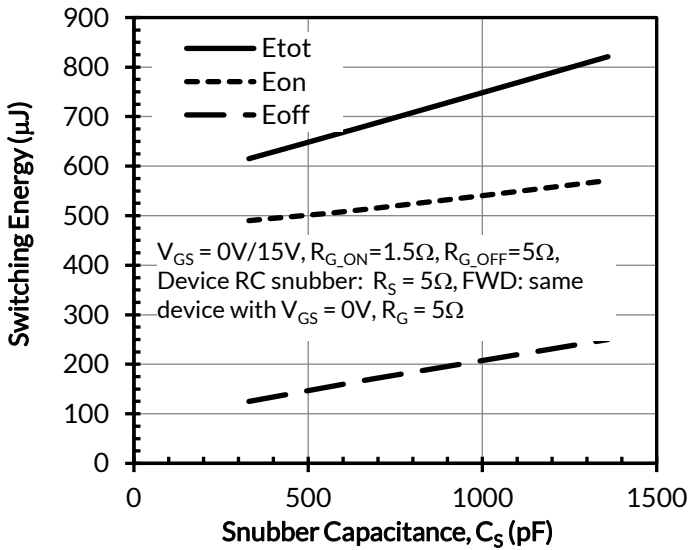

Figure 25. Clamped inductive switching energies vs. snubber capacitance C_S at $V_{DS} = 400V$, $I_D = 80A$, and $T_J = 25^\circ C$

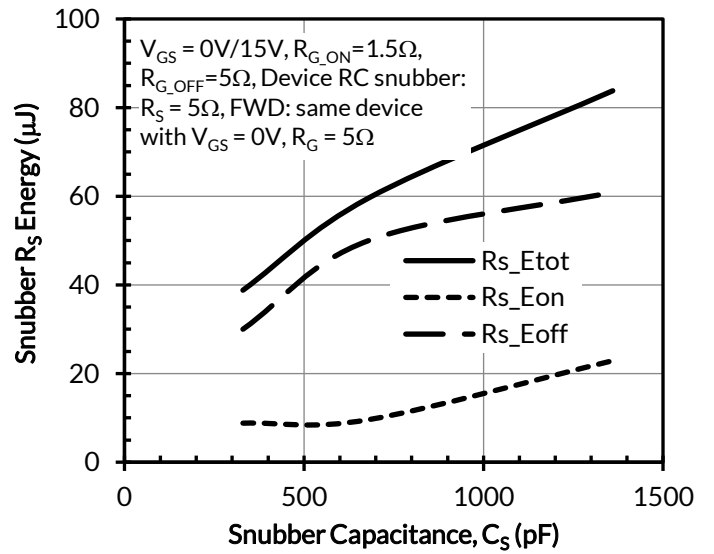

Figure 26. RC snubber energy losses vs. snubber capacitance C_S at $V_{DS} = 400V$, $I_D = 80A$, and $T_J = 25^\circ C$

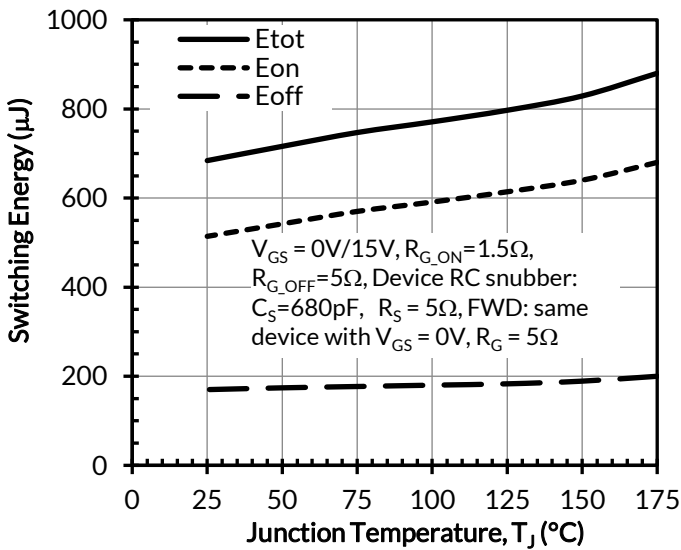

Figure 27. Clamped inductive switching energy vs. junction temperature at $V_{DS} = 400V$ and $I_D = 80A$

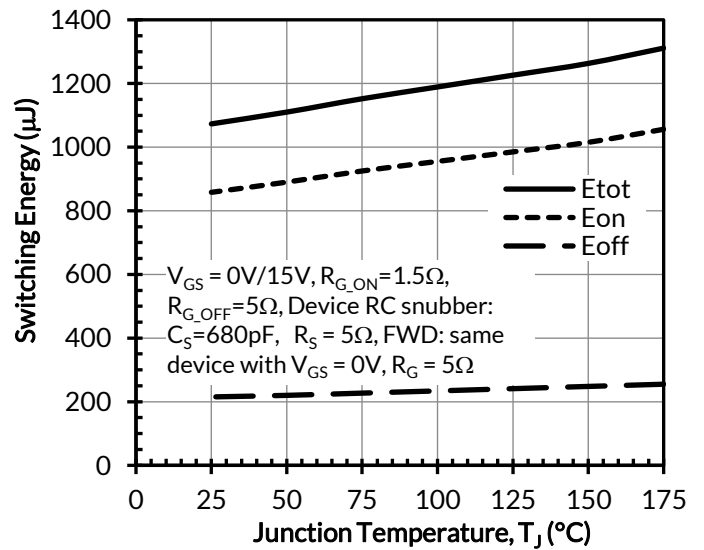

Figure 28. Clamped inductive switching energy vs. junction temperature at $V_{DS} = 500V$ and $I_D = 80A$

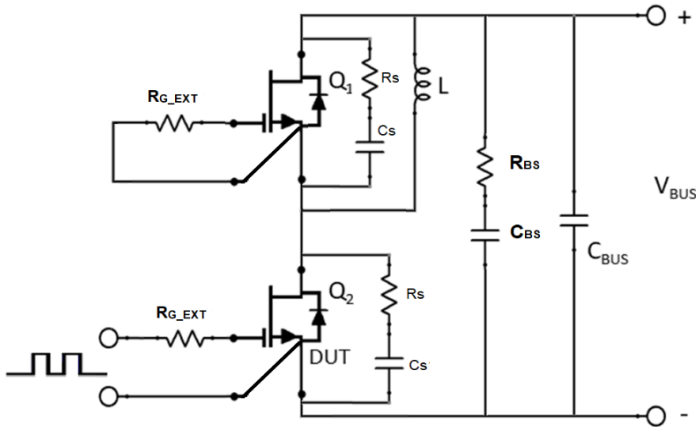

Figure 29. Schematic of the half-bridge mode switching test circuit. Note, a bus RC snubber ($R_{BS} = 1\Omega$, $C_{BS} = 100\text{nF}$) is used to reduce the power loop high frequency oscillations.

Applications Information

SiC FETs are enhancement-mode power switches formed by a high-voltage SiC depletion-mode JFET and a low-voltage silicon MOSFET connected in series. The silicon MOSFET serves as the control unit while the SiC JFET provides high voltage blocking in the off state. This combination of devices in a single package provides compatibility with standard gate drivers and offers superior performance in terms of low on-resistance ($R_{DS(on)}$), output capacitance (C_{oss}), gate charge (Q_G), and reverse recovery charge (Q_{rr}) leading to low conduction and switching losses. The SiC FETs also provide excellent reverse conduction capability eliminating the need for an external anti-parallel diode.

Like other high performance power switches, proper PCB layout design to minimize circuit parasitics is strongly recommended due to the high dv/dt and di/dt rates. An external gate resistor is recommended when the FET is working in the diode mode in order to achieve the optimum reverse recovery performance. For more information on SiC FET operation, see www.unitedsic.com.

Disclaimer

UnitedSiC reserves the right to change or modify any of the products and their inherent physical and technical specifications without prior notice. UnitedSiC assumes no responsibility or liability for any errors or inaccuracies within.

Information on all products and contained herein is intended for description only. No license, express or implied, to any intellectual property rights is granted within this document.

UnitedSiC assumes no liability whatsoever relating to the choice, selection or use of the UnitedSiC products and services described herein.

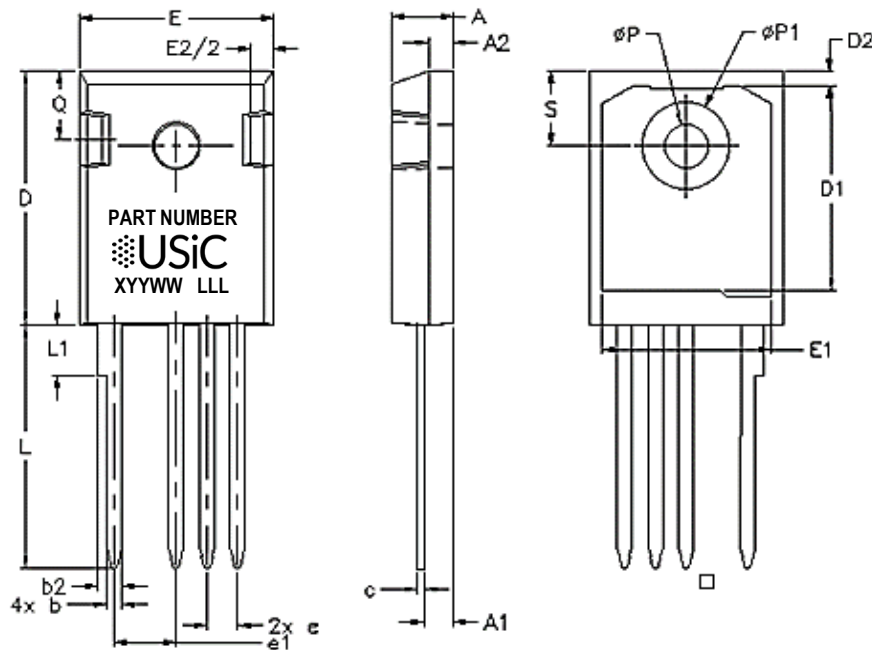
PACKAGE OUTLINE

DIM	INCHES		MILLIMETERS	
	MIN	MAX	MIN	MAX
A	0.185	0.209	4.7	5.31
A1	0.087	0.102	2.21	2.59
A2	0.059	0.098	1.5	2.49
b	0.039	0.055	0.99	1.4
b2	0.065	0.094	1.65	2.39
c	0.015	0.035	0.38	0.89
D	0.819	0.845	20.8	21.46
D1	0.515	-	13.08	-
D2	0.02	0.053	0.51	1.35
E	0.61	0.64	15.49	16.26
e	0.100 BSC		2.54 BSC	
e1	0.19	0.21	4.83	5.33
E1	0.53	-	13.46	-
E2	0.14	0.16	3.56	4.06
L	0.78	0.8	19.81	20.32
L1	-	0.177	-	4.5
ϕP	0.14	0.144	3.56	3.66
$\phi P1$	0.278	0.291	7.06	7.39
Q	0.212	0.244	5.38	6.2
S	0.243 BSC		6.17 BSC	



PART MARKING

TO-247-4L PACKAGE OUTLINE, PART MARKING AND TUBE SPECIFICATIONS

PART NUMBER

The logo for USiC, featuring a circular pattern of black dots on the left and the text "USiC" in a large, bold, black sans-serif font on the right.
XYYWW LLL

PART NUMBER = REFER TO
DS_PN DECODER FOR DETAILS

X = ASSEMBLY SITE

YY = YEAR

WW = WORK WEEK

LLL = LOT ID

PACKING TYPE

ANTI-STATIC TUBE

QUANTITY /TUBE : 30 UNITS

DISCLAIMER

United Silicon Carbide, Inc. reserves the right to change or modify any of the products and their inherent physical and technical specifications without prior notice. United Silicon Carbide, Inc. assumes no responsibility or liability for any errors or inaccuracies within.

Information on all products and contained herein is intended for description only. No license, express or implied, to any intellectual property rights is granted within this document.

United Silicon Carbide, Inc. assumes no liability whatsoever relating to the choice, selection or use of the United Silicon Carbide, Inc. products and services described herein.

onsemi, **Onsemi**, and other names, marks, and brands are registered and/or common law trademarks of Semiconductor Components Industries, LLC dba "**onsemi**" or its affiliates and/or subsidiaries in the United States and/or other countries. **onsemi** owns the rights to a number of patents, trademarks, copyrights, trade secrets, and other intellectual property. A listing of **onsemi**'s product/patent coverage may be accessed at www.onsemi.com/site/pdf/Patent-Marking.pdf. **onsemi** reserves the right to make changes at any time to any products or information herein, without notice. The information herein is provided "as-is" and **onsemi** makes no warranty, representation or guarantee regarding the accuracy of the information, product features, availability, functionality, or suitability of its products for any particular purpose, nor does **onsemi** assume any liability arising out of the application or use of any product or circuit, and specifically disclaims any and all liability, including without limitation special, consequential or incidental damages. Buyer is responsible for its products and applications using **onsemi** products, including compliance with all laws, regulations and safety requirements or standards, regardless of any support or applications information provided by **onsemi**. "Typical" parameters which may be provided in **onsemi** data sheets and/or specifications can and do vary in different applications and actual performance may vary over time. All operating parameters, including "Typicals" must be validated for each customer application by customer's technical experts. **onsemi** does not convey any license under any of its intellectual property rights nor the rights of others. **onsemi** products are not designed, intended, or authorized for use as a critical component in life support systems or any FDA Class 3 medical devices or medical devices with a same or similar classification in a foreign jurisdiction or any devices intended for implantation in the human body. Should Buyer purchase or use **onsemi** products for any such unintended or unauthorized application, Buyer shall indemnify and hold **onsemi** and its officers, employees, subsidiaries, affiliates, and distributors harmless against all claims, costs, damages, and expenses, and reasonable attorney fees arising out of, directly or indirectly, any claim of personal injury or death associated with such unintended or unauthorized use, even if such claim alleges that **onsemi** was negligent regarding the design or manufacture of the part. **onsemi** is an Equal Opportunity/Affirmative Action Employer. This literature is subject to all applicable copyright laws and is not for resale in any manner.

ADDITIONAL INFORMATION

TECHNICAL PUBLICATIONS:

Technical Library: www.onsemi.com/design/resources/technical-documentation
onsemi Website: www.onsemi.com

ONLINE SUPPORT: www.onsemi.com/support

For additional information, please contact your local Sales Representative at www.onsemi.com/support/sales