

# ESD Protection Diode Array

## Dual Common Anode

### SM05T1G Series

These dual monolithic silicon surge protection diodes are designed for applications requiring transient overvoltage protection capability. They are intended for use in voltage and ESD sensitive equipment such as computers, printers, business machines, communication systems, medical equipment and other applications. Their dual junction common anode design protects two separate lines using only one package. These devices are ideal for situations where board space is at a premium.

#### Specification Features:

- SOT-23 Package Allows Either Two Separate Unidirectional Configurations or a Single Bidirectional Configuration
- Working Peak Reverse Voltage Range – 5.0 V to 36 V
- Peak Power – 300 Watt (8/20  $\mu$ s)
- Low Leakage – 1.0  $\mu$ A
- Flammability Rating UL 94 V-0
- SZ Prefix for Automotive and Other Applications Requiring Unique Site and Control Change Requirements; AEC-Q101 Qualified and PPAP Capable
- These are Pb-Free Devices

#### Mechanical Characteristics:

**CASE:** Void-Free, Transfer-Molded, Thermosetting Plastic Case

**FINISH:** Corrosion Resistant Finish, Easily Solderable

#### MAXIMUM CASE TEMPERATURE FOR SOLDERING PURPOSES:

260°C for 10 Seconds

Package Designed for Optimal Automated Board Assembly

Small Package Size for High Density Applications

Available in 8 mm Tape and Reel

Use the Device Number to Order the 7 Inch/3,000 Unit Reel

Replace the “T1” with “T3” in the Device Number to Order the

13 Inch/10,000 Unit Reel

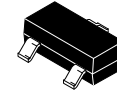

SOT-23  
CASE 318  
STYLE 12

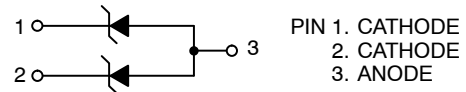

#### MARKING DIAGRAM

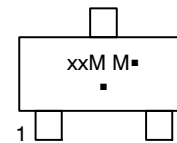

xxM = Device Code  
xx = 05, 12, 15, 24, 36  
M = Date Code\*  
▪ = Pb-Free Package

(Note: Microdot may be in either location)

\*Date Code orientation and/or overbar may vary depending upon manufacturing location.

#### ORDERING INFORMATION

Device	Package	Shipping <sup>†</sup>
SM05T1G	SOT-23 (Pb-Free)	3,000/Tape & Reel
SZSM05T1G		
SM15T1G		
SM24T1G		
SZSM24T1G		
SM36T1G		

<sup>†</sup>For information on tape and reel specifications, including part orientation and tape sizes, please refer to our Tape and Reel Packaging Specifications Brochure, BRD8011/D.

# SM05T1G Series

## MAXIMUM RATINGS

Rating	Symbol	Value	Unit
Peak Power Dissipation @ 20 $\mu$ s (Note 1) @ $T_L \leq 25^\circ\text{C}$	$P_{pk}$	300	W
IEC 61000-4-2 (ESD) Air Contact		$\pm 15$ $\pm 26$	kV
IEC 61000-4-4 (EFT)		40	A
IEC 61000-4-5 (Lightning)		12	A
Total Power Dissipation on FR-5 Board (Note 2) @ $T_A = 25^\circ\text{C}$ Derate above $25^\circ\text{C}$ Thermal Resistance, Junction-to-Ambient	$P_D$ $R_{\theta JA}$	225 1.8 556	mW mW/ $^\circ\text{C}$ $^\circ\text{C}/\text{W}$
Total Power Dissipation on Alumina Substrate (Note 3) @ $T_A = 25^\circ\text{C}$ Derate above $25^\circ\text{C}$ Thermal Resistance, Junction-to-Ambient	$P_D$ $R_{\theta JA}$	300 2.4 417	mW mW/ $^\circ\text{C}$ $^\circ\text{C}/\text{W}$
Junction and Storage Temperature Range	$T_J, T_{stg}$	- 55 to +150	$^\circ\text{C}$
Lead Solder Temperature - Maximum (10 Second Duration)	$T_L$	260	$^\circ\text{C}$

Stresses exceeding those listed in the Maximum Ratings table may damage the device. If any of these limits are exceeded, device functionality should not be assumed, damage may occur and reliability may be affected.

1. Non-repetitive current pulse per Figure 3
  2. FR-5 = 1.0 x 0.75 x 0.62 in.
  3. Alumina = 0.4 x 0.3 x 0.024 in., 99.5% alumina
- NOTE: Other voltages may be available upon request

## ELECTRICAL CHARACTERISTICS

**UNIDIRECTIONAL** (Circuit tied to Pins 1 and 3 or 2 and 3)

Symbol	Parameter
$I_{PP}$	Maximum Reverse Peak Pulse Current
$V_C$	Clamping Voltage @ $I_{PP}$
$V_{RWM}$	Working Peak Reverse Voltage
$I_R$	Maximum Reverse Leakage Current @ $V_{RWM}$
$V_{BR}$	Breakdown Voltage @ $I_T$
$I_T$	Test Current
$\Theta V_{BR}$	Maximum Temperature Coefficient of $V_{BR}$
$I_F$	Forward Current
$V_F$	Forward Voltage @ $I_F$
$Z_{ZT}$	Maximum Zener Impedance @ $I_{ZT}$
$I_{ZK}$	Reverse Current
$Z_{ZK}$	Maximum Zener Impedance @ $I_{ZK}$

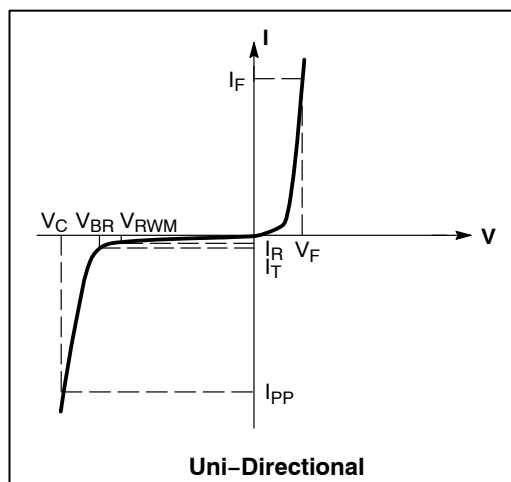

## ELECTRICAL CHARACTERISTICS ( $T_A = 25^\circ\text{C}$ unless otherwise noted)

Device*	Device Marking	$V_{RWM}$ (Volts)	$I_R$ @ $V_{RWM}$ ( $\mu\text{A}$ )	$V_{BR}$ , Breakdown Voltage		$I_T$ mA	$V_C$ @ $I_{PP} = 1$ Amp (Volts)	Max $I_{PP}$ (Note 4) (Amps)	Typical Capacitance
				(Volts)					Pin 1 to 3 @ 0 Volts (pF)
				Min	Max				
SM05T1G	05M	5	10	6.2	7.3	1.0	9.8	17	225
SM12T1G	12M	12	1.0	13.3	15.75	1.0	19	12	95
SM15T1G	15M	15	1.0	16.7	19.6	1.0	24	10	100
SM24T1G	24M	24	1.0	26.7	31.35	1.0	43	5.0	60
SM36T1G	36M	36	1.0	40.0	46.95	1.0	60	4.0	45

Product parametric performance is indicated in the Electrical Characteristics for the listed test conditions, unless otherwise noted. Product performance may not be indicated by the Electrical Characteristics if operated under different conditions.

4. 8/20  $\mu$ s pulse waveform per Figure 3

\*Include SZ-prefix devices where applicable.

# SM05T1G Series

## TYPICAL CHARACTERISTICS

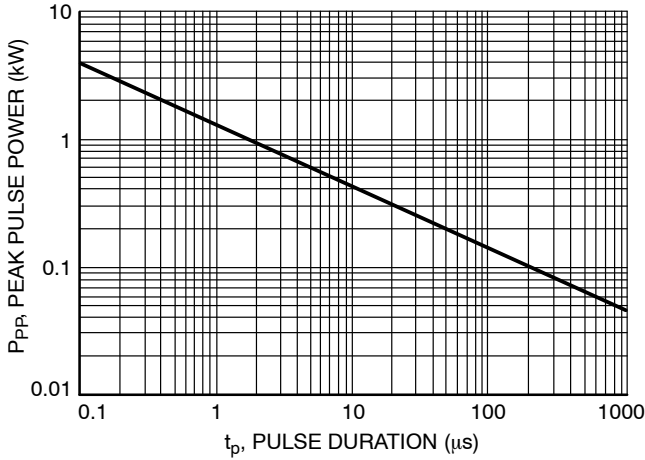

Figure 1. Non-Repetitive Peak Pulse Power versus Pulse Time

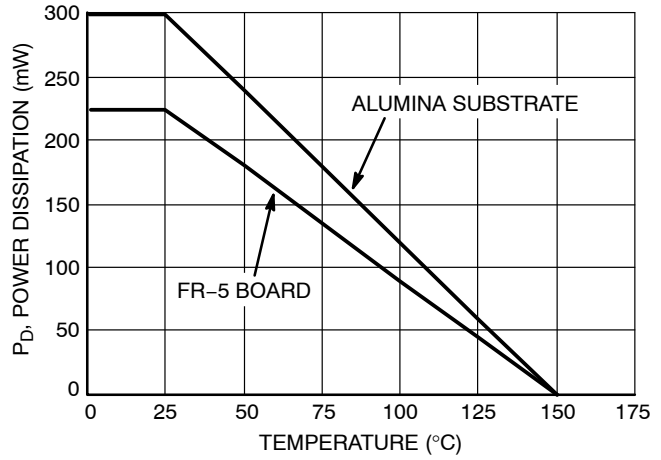

Figure 2. Steady State Power Derating Curve

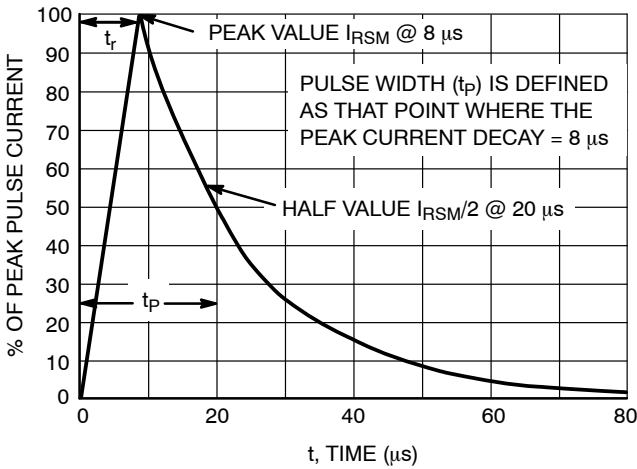

Figure 3. 8/20  $\mu$ s Pulse Waveform

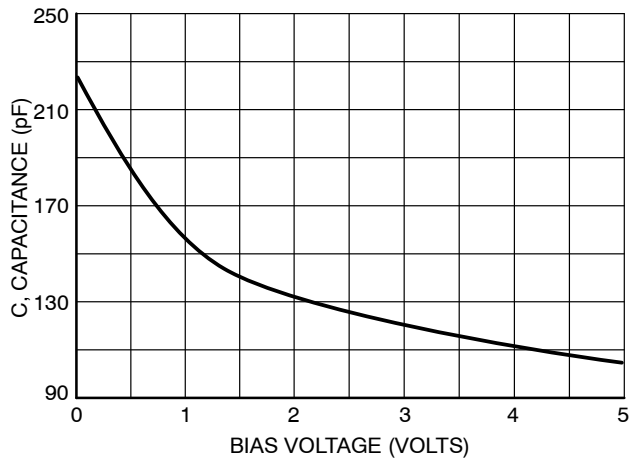

Figure 4. Typical Diode Capacitance (SM05)

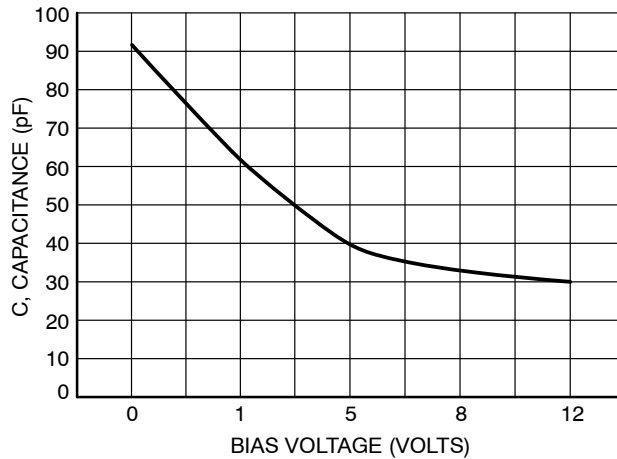

Figure 5. Typical Diode Capacitance (SM12)

# SM05T1G Series

## TYPICAL COMMON ANODE APPLICATIONS

A quad junction common anode design in a SOT-23 package protects four separate lines using only one package. This adds flexibility and creativity to PCB design especially

when board space is at a premium. Two simplified examples of surge protection applications are illustrated below.

### Computer Interface Protection

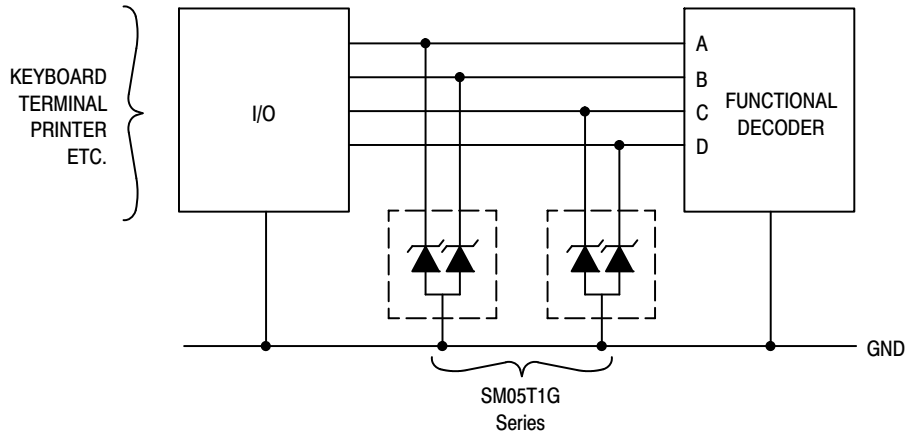

### Microprocessor Protection

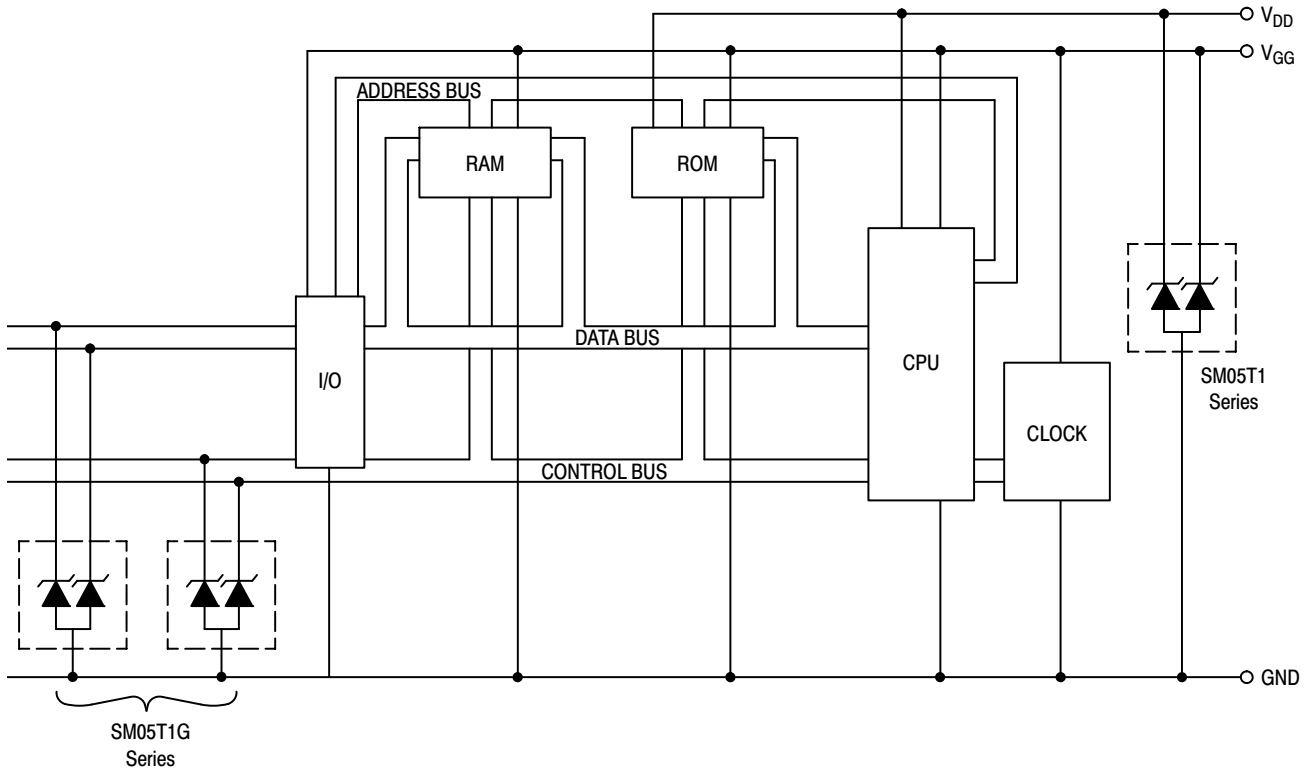



SCALE 4:1

**SOT-23 (TO-236) 2.90x1.30x1.00 1.90P**  
CASE 318  
ISSUE AU

DATE 14 AUG 2024

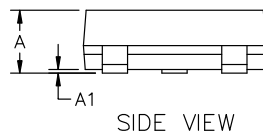

MILLIMETERS			
DIM	MIN	NOM	MAX
A	0.89	1.00	1.11
A1	0.01	0.06	0.10
b	0.37	0.44	0.50
c	0.08	0.14	0.20
D	2.80	2.90	3.04
E	1.20	1.30	1.40
e	1.78	1.90	2.04
L	0.30	0.43	0.55
L1	0.35	0.54	0.69
HE	2.10	2.40	2.64
T	0°	---	10°

NOTES:

1. DIMENSIONING AND TOLERANCING PER ASME Y14.5M, 2018.
2. CONTROLLING DIMENSIONS: MILLIMETERS.
3. MAXIMUM LEAD THICKNESS INCLUDES LEAD FINISH. MINIMUM LEAD THICKNESS IS THE MINIMUM THICKNESS OF THE BASE MATERIAL.
4. DIMENSIONS D AND E DO NOT INCLUDE MOLD FLASH, PROTRUSIONS, OR GATE BURRS.

**GENERIC MARKING DIAGRAM\***



XXX = Specific Device Code  
M = Date Code  
▪ = Pb-Free Package

\*This information is generic. Please refer to device data sheet for actual part marking. Pb-Free indicator, "G" or microdot "▪", may or may not be present. Some products may not follow the Generic Marking.

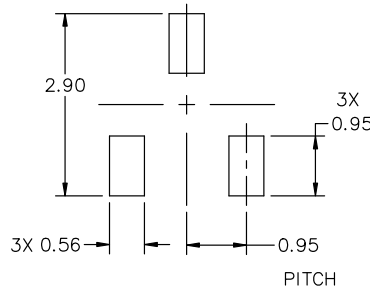

\* For additional information on our Pb-Free strategy and soldering details, please download the onsemi Soldering and Mounting Techniques Reference Manual, SOLDERRM/D.

**STYLES ON PAGE 2**

<b>DOCUMENT NUMBER:</b>	<b>98ASB42226B</b>	Electronic versions are uncontrolled except when accessed directly from the Document Repository. Printed versions are uncontrolled except when stamped "CONTROLLED COPY" in red.
<b>DESCRIPTION:</b>	<b>SOT-23 (TO-236) 2.90x1.30x1.00 1.90P</b>	<b>PAGE 1 OF 2</b>

onsemi and ONSEMI are trademarks of Semiconductor Components Industries, LLC dba onsemi or its subsidiaries in the United States and/or other countries. onsemi reserves the right to make changes without further notice to any products herein. onsemi makes no warranty, representation or guarantee regarding the suitability of its products for any particular purpose, nor does onsemi assume any liability arising out of the application or use of any product or circuit, and specifically disclaims any and all liability, including without limitation special, consequential or incidental damages. onsemi does not convey any license under its patent rights nor the rights of others.

**SOT-23 (TO-236) 2.90x1.30x1.00 1.90P**  
**CASE 318**  
**ISSUE AU**

DATE 14 AUG 2024

STYLE 1 THRU 5:  
CANCELLED

STYLE 6:  
PIN 1. BASE  
2. EMITTER  
3. COLLECTOR

STYLE 7:  
PIN 1. EMITTER  
2. BASE  
3. COLLECTOR

STYLE 8:  
PIN 1. ANODE  
2. NO CONNECTION  
3. CATHODE

STYLE 9:  
PIN 1. ANODE  
2. ANODE  
3. CATHODE

STYLE 10:  
PIN 1. DRAIN  
2. SOURCE  
3. GATE

STYLE 11:  
PIN 1. ANODE  
2. CATHODE  
3. CATHODE-ANODE

STYLE 12:  
PIN 1. CATHODE  
2. CATHODE  
3. ANODE

STYLE 13:  
PIN 1. SOURCE  
2. DRAIN  
3. GATE

STYLE 14:  
PIN 1. CATHODE  
2. GATE  
3. ANODE

STYLE 15:  
PIN 1. GATE  
2. CATHODE  
3. ANODE

STYLE 16:  
PIN 1. ANODE  
2. CATHODE  
3. CATHODE

STYLE 17:  
PIN 1. NO CONNECTION  
2. ANODE  
3. CATHODE

STYLE 18:  
PIN 1. NO CONNECTION  
2. CATHODE  
3. ANODE

STYLE 19:  
PIN 1. CATHODE  
2. ANODE  
3. CATHODE-ANODE

STYLE 20:  
PIN 1. CATHODE  
2. ANODE  
3. GATE

STYLE 21:  
PIN 1. GATE  
2. SOURCE  
3. DRAIN

STYLE 22:  
PIN 1. RETURN  
2. OUTPUT  
3. INPUT

STYLE 23:  
PIN 1. ANODE  
2. ANODE  
3. CATHODE

STYLE 24:  
PIN 1. GATE  
2. DRAIN  
3. SOURCE

STYLE 25:  
PIN 1. ANODE  
2. CATHODE  
3. GATE

STYLE 26:  
PIN 1. CATHODE  
2. ANODE  
3. NO CONNECTION

STYLE 27:  
PIN 1. CATHODE  
2. CATHODE  
3. CATHODE

STYLE 28:  
PIN 1. ANODE  
2. ANODE  
3. ANODE

<b>DOCUMENT NUMBER:</b>	<b>98ASB42226B</b>	Electronic versions are uncontrolled except when accessed directly from the Document Repository. Printed versions are uncontrolled except when stamped "CONTROLLED COPY" in red.
<b>DESCRIPTION:</b>	<b>SOT-23 (TO-236) 2.90x1.30x1.00 1.90P</b>	<b>PAGE 2 OF 2</b>

**onsemi** and **ONSEMI** are trademarks of Semiconductor Components Industries, LLC dba **onsemi** or its subsidiaries in the United States and/or other countries. **onsemi** reserves the right to make changes without further notice to any products herein. **onsemi** makes no warranty, representation or guarantee regarding the suitability of its products for any particular purpose, nor does **onsemi** assume any liability arising out of the application or use of any product or circuit, and specifically disclaims any and all liability, including without limitation special, consequential or incidental damages. **onsemi** does not convey any license under its patent rights nor the rights of others.

**onsemi**, **Onsemi**, and other names, marks, and brands are registered and/or common law trademarks of Semiconductor Components Industries, LLC dba "**onsemi**" or its affiliates and/or subsidiaries in the United States and/or other countries. **onsemi** owns the rights to a number of patents, trademarks, copyrights, trade secrets, and other intellectual property. A listing of **onsemi**'s product/patent coverage may be accessed at [www.onsemi.com/site/pdf/Patent-Marking.pdf](http://www.onsemi.com/site/pdf/Patent-Marking.pdf). **onsemi** reserves the right to make changes at any time to any products or information herein, without notice. The information herein is provided "as-is" and **onsemi** makes no warranty, representation or guarantee regarding the accuracy of the information, product features, availability, functionality, or suitability of its products for any particular purpose, nor does **onsemi** assume any liability arising out of the application or use of any product or circuit, and specifically disclaims any and all liability, including without limitation special, consequential or incidental damages. Buyer is responsible for its products and applications using **onsemi** products, including compliance with all laws, regulations and safety requirements or standards, regardless of any support or applications information provided by **onsemi**. "Typical" parameters which may be provided in **onsemi** data sheets and/or specifications can and do vary in different applications and actual performance may vary over time. All operating parameters, including "Typicals" must be validated for each customer application by customer's technical experts. **onsemi** does not convey any license under any of its intellectual property rights nor the rights of others. **onsemi** products are not designed, intended, or authorized for use as a critical component in life support systems or any FDA Class 3 medical devices or medical devices with a same or similar classification in a foreign jurisdiction or any devices intended for implantation in the human body. Should Buyer purchase or use **onsemi** products for any such unintended or unauthorized application, Buyer shall indemnify and hold **onsemi** and its officers, employees, subsidiaries, affiliates, and distributors harmless against all claims, costs, damages, and expenses, and reasonable attorney fees arising out of, directly or indirectly, any claim of personal injury or death associated with such unintended or unauthorized use, even if such claim alleges that **onsemi** was negligent regarding the design or manufacture of the part. **onsemi** is an Equal Opportunity/Affirmative Action Employer. This literature is subject to all applicable copyright laws and is not for resale in any manner.

## ADDITIONAL INFORMATION

### TECHNICAL PUBLICATIONS:

Technical Library: [www.onsemi.com/design/resources/technical-documentation](http://www.onsemi.com/design/resources/technical-documentation)  
onsemi Website: [www.onsemi.com](http://www.onsemi.com)

### ONLINE SUPPORT: [www.onsemi.com/support](http://www.onsemi.com/support)

For additional information, please contact your local Sales Representative at [www.onsemi.com/support/sales](http://www.onsemi.com/support/sales)