

SiC Power MOSFET Module

1200 V, 80 mΩ, 20 A 3-Phase Bridge Power Module NVXK2VR80WDT2

Features

- DIP Silicon Carbide 3-Phase Bridge Power Module for On-board Charger (OBC) for xEV Applications
- Creepage and Clearance per IEC 60664-1, IEC 60950-1
- Compact Design for Low Total Module Resistance
- Module Serialization for Full Traceability
- Lead Free, ROHS and UL94V-0 Compliant
- Automotive Qualified per AEC-Q101 and AQG324

Typical Applications

- PFC for On-Board Charger in xEV Applications

MAXIMUM RATINGS (T_J = 25°C unless otherwise noted)

Parameter	Symbol	Value	Unit
Drain-to-Source Voltage	V _{DSS}	1200	V
Gate-to-Source Voltage	V _{GS}	+25/-15	V
Recommended Operation Values of Gate-to-Source Voltage, T _J ≤ 175°C	V _{GSop}	+20/-5	V
Continuous Drain Current (Note 1)	T _C = 25°C	I _D	20
		P _D	82
Power Dissipation (Note 1)			W
Pulsed Drain Current (Note 2)	T _C = 25°C	I _{DM}	96
Single Pulse Surge Drain Current Capability	T _C = 25°C, t _p = 10 μs, R _G = 4.7 Ω	I _{DSC}	266
Operating Junction Temperature	T _J	-55 to 175	°C
Storage Temperature	T _{stg}	-40 to 125	°C
Source Current (Body Diode)	I _S	18	A
Single Pulse Drain-to-Source Avalanche Energy (Note 3)	E _{AS}	180	mJ

Stresses exceeding those listed in the Maximum Ratings table may damage the device. If any of these limits are exceeded, device functionality should not be assumed, damage may occur and reliability may be affected.

THERMAL CHARACTERISTICS (Note 1)

Parameter	Symbol	Typ	Max	Unit
Thermal Resistance Junction-to-Case (Note 1)	R _{θJC}	1.41	1.84	°C/W
Thermal Resistance Junction-to-Sink (Note 1)	R _{ψJS}	1.84	2.26	°C/W

1. Particular conditions specified determine thermal resistance values shown. Infinite heatsink with T_C = 100°C for R_{θJC}. For R_{ψJS} assembled to 3 mm thick aluminum heatsink with infinite cooling bottom surface at 85°C, through 38 μm thick TIM with 6.5 W/mK thermal conductivity.
2. Repetitive rating limited by maximum junction temperature and transconductance.
3. E_{AS} based on initial T_J = 25°C, L = 1 mH, I_{AS} = 19 A, V_{DD} = 120 V, V_{GS} = 18 V.

V _{(BR)DSS}	R _{DS(on) Max}	I _{D Max}
1200 V	116 mΩ @ 20 V	20 A

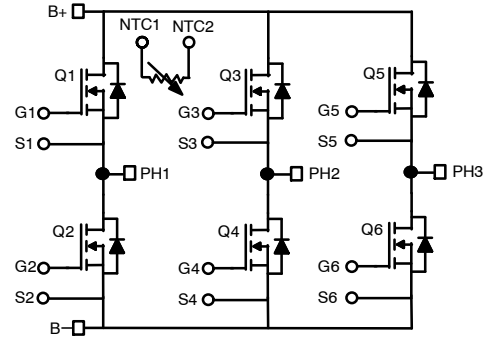

SiC MOSFET 3-Phase Bridge Module

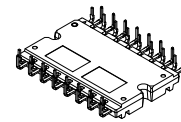

APM32
44.00x28.80x5.70
CASE MODHM

MARKING DIAGRAM

NVXK2VR80WDT2
ZZZ ATYWW
NNNNNNNN

NVXK2VR80WDT2 = Specific Device Code
ZZZ = Lot Number
AT = Assembly Site & Test Location
Y = Year
W = Work Week
NNN = Serial Number

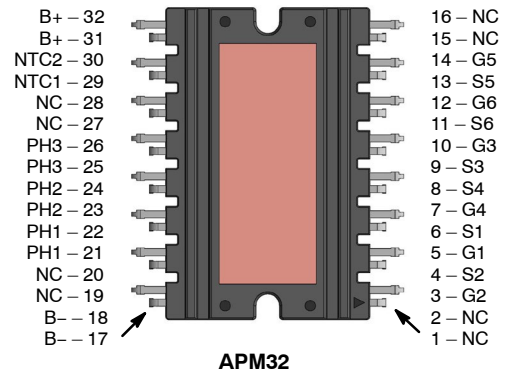

APM32

ORDERING INFORMATION

Device	Package	Shipping
NVXK2VR80WDT2	APM32 (Pb-Free)	10 ea / Tube

NVXK2VR80WDT2

PIN DESCRIPTION

Pin No.	Name	Description
1, 2, 15, 16, 19, 20, 27, 28	NC	Not Connected
3	G2	Q2 Gate
4	S2	Q2 Source
5	G1	Q1 Gate
6	S1	Q1 Source
7	G4	Q4 Gate
8	S4	Q4 Source
9	S3	Q3 Source
10	G3	Q3 Gate
11	S6	Q6 Source
12	G6	Q6 Gate
13	S5	Q5 Source
14	G5	Q5 Gate
17, 18	B-	Negative Power Terminal
21, 22	PH1	Phase 1 Output
23, 24	PH2	Phase 2 Output
25, 26	PH3	Phase 3 Output
29	NTC1	NTC pin1
30	NTC2	NTC pin2
31, 32	B+	Positive Power Terminal

ELECTRICAL CHARACTERISTICS (T_J = 25°C unless otherwise stated)

Parameter	Symbol	Test Conditions	Min	Typ	Max	Unit
-----------	--------	-----------------	-----	-----	-----	------

OFF CHARACTERISTICS

Drain-to-Source Breakdown Voltage	V _{(BR)DSS}	V _{GS} = 0 V, I _D = 1 mA	1200	-	-	V	
Drain-to-Source Breakdown Voltage Temperature Coefficient	B _{(BR)DSS/T_J}	I _D = 1 mA, referenced to 25°C	-	500	-	mV/°C	
Zero Gate Voltage Drain Current	I _{DSS}	V _{GS} = 0 V, V _{DS} = 1200 V	T _J = 25°C	-	-	100	μA
			T _J = 175°C	-	-	1	mA
Gate-to-Source Leakage Current	I _{GSS}	V _{GS} = +25/-15 V, V _{DS} = 0 V	-	-	±1	μA	

ON CHARACTERISTICS (Note 4)

Gate Threshold Voltage	V _{GS(TH)}	V _{GS} = V _{DS} , I _D = 5 mA	1.8	3	4.3	V
Recommended Gate Voltage	V _{GOP}		-5	-	+20	V
Drain-to-Source On Resistance	R _{DS(on)}	V _{GS} = 20 V, I _D = 20 A, T _J = 25°C	-	80	116	mΩ
		V _{GS} = 20 V, I _D = 20 A, T _J = 175°C	-	150	-	mΩ
Forward Transconductance	g _{FS}	V _{DS} = 20 V, I _D = 20 A	-	11	-	S

CHARGES, CAPACITANCES & GATE RESISTANCE

Input Capacitance	C _{ISS}	V _{GS} = 0 V, f = 1 MHz, V _{DS} = 800 V	-	1154	-	pF
Output Capacitance	C _{OSS}		-	79	-	
Reverse Transfer Capacitance	C _{RSS}		-	7.9	-	

NVXK2VR80WDT2

ELECTRICAL CHARACTERISTICS ($T_J = 25^\circ\text{C}$ unless otherwise stated) (continued)

Parameter	Symbol	Test Conditions	Min	Typ	Max	Unit
CHARGES, CAPACITANCES & GATE RESISTANCE						
Total Gate Charge	$Q_{G(TOT)}$	$V_{GS} = -5/20\text{ V}$, $V_{DS} = 600\text{ V}$, $I_D = 20\text{ A}$	-	56	-	nC
Threshold Gate Charge	$Q_{G(TH)}$		-	10	-	
Gate-to-Source Charge	Q_{GS}		-	18	-	
Gate-to-Drain Charge	Q_{GD}		-	11	-	
Gate-Resistance	R_G	$V_{GS} = 0\text{ V}$, $f = 1\text{ MHz}$	-	1.2	-	Ω

INDUCTIVE SWITCHING CHARACTERISTICS

Turn-On Delay Time	$t_{d(ON)}$	$V_{GS} = -5/20\text{ V}$, $V_{DS} = 800\text{ V}$, $I_D = 20\text{ A}$, $R_G = 4.7\ \Omega$, Inductive load	-	12	-	ns
Rise Time	t_r		-	12	-	
Turn-Off Delay Time	$t_{d(OFF)}$		-	21	-	
Fall Time	t_f		-	9	-	
Turn-On Switching Loss	E_{ON}		-	135	-	μJ
Turn-Off Switching Loss	E_{OFF}		-	46	-	μJ
Total Switching Loss	E_{tot}		-	181	-	μJ

DRAIN-SOURCE DIODE CHARACTERISTICS

Continuous Drain-Source Diode Forward Current (Note 1)	I_{SD}	$V_{GS} = -5\text{ V}$, $T_J = 25^\circ\text{C}$	-	-	18	A
Pulsed Drain-Source Diode Forward Current (Note 2)	I_{SDM}	$V_{GS} = -5\text{ V}$, $T_J = 25^\circ\text{C}$	-	-	96	A
Forward Diode Voltage	V_{SD}	$V_{GS} = -5\text{ V}$, $I_{SD} = 10\text{ A}$, $T_J = 25^\circ\text{C}$	-	3.9	-	V
Reverse Recovery Time	t_{RR}	$V_{GS} = -5\text{ V}$, $di_S/dt = 1000\text{ A}/\mu\text{s}$, $I_{SD} = 20\text{ A}$	-	16.2	-	ns
Peak Reverse Recovery Current	I_{RRM}		-	7.6	-	A
Reverse Recovery Energy	E_{REC}		-	4.1	-	μJ
Reverse Recovery Charge	Q_{RR}		-	61.6	-	nC

Product parametric performance is indicated in the Electrical Characteristics for the listed test conditions, unless otherwise noted. Product performance may not be indicated by the Electrical Characteristics if operated under different conditions.

4. Pulse test: pulse width $\leq 300\ \mu\text{s}$, duty ratio $\leq 2\%$.

COMPONENTS

Component	Description	Type	Quantity	Specification
NTC	10 k Ω , $\pm 3\%$ Case Size 0603	Discrete	1	B Constants $B_{25/50} = 3590$ $B_{25/85} = 3635$ $B_{25/100} = 3650 \pm 3\%$

NVXK2VR80WDT2

TYPICAL CHARACTERISTICS

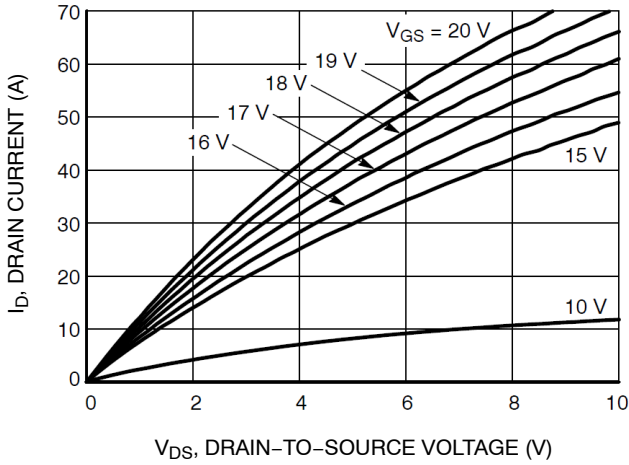

Figure 1. On-Region Characteristics

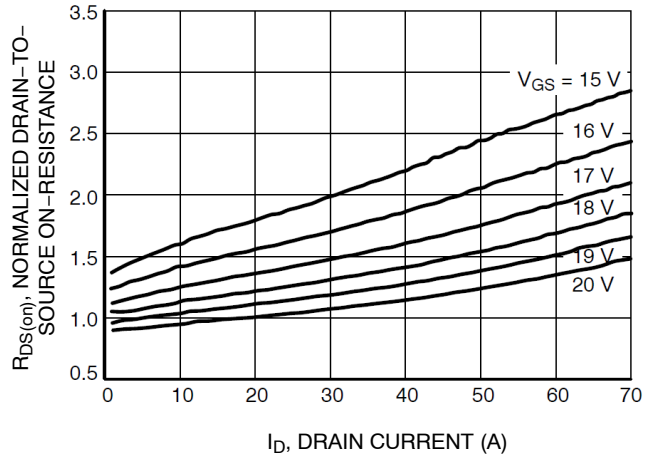

Figure 2. Normalized On-Resistance vs. Drain Current and Gate Voltage

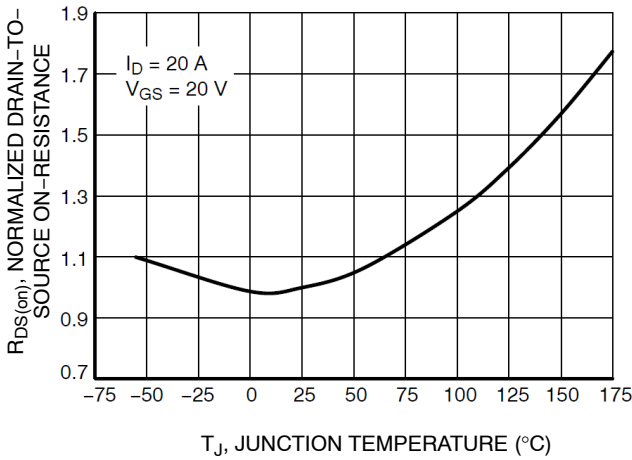

Figure 3. On-Resistance Variation with Temperature

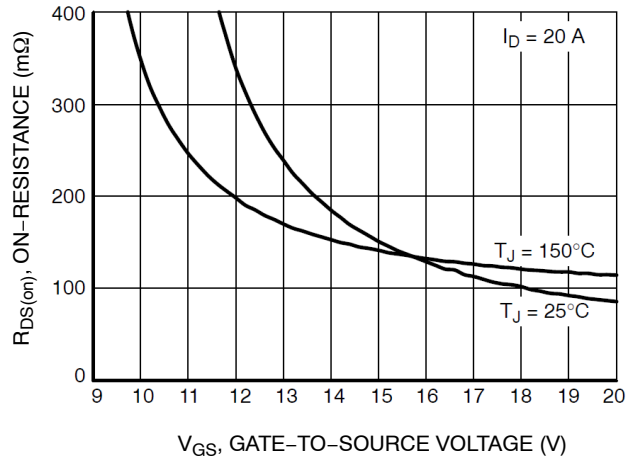

Figure 4. On-Resistance vs. Gate-to-Source Voltage

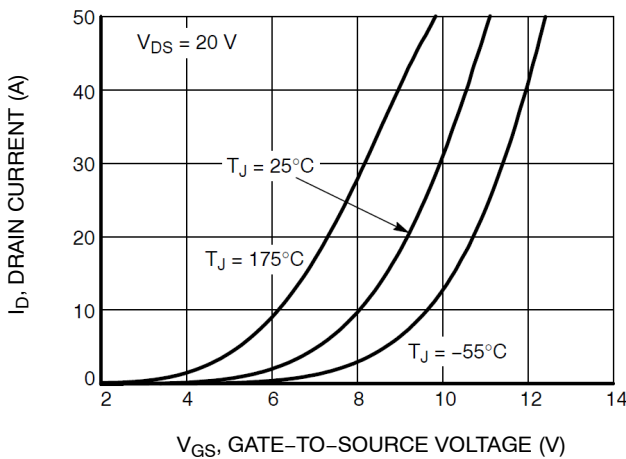

Figure 5. Transfer Characteristics

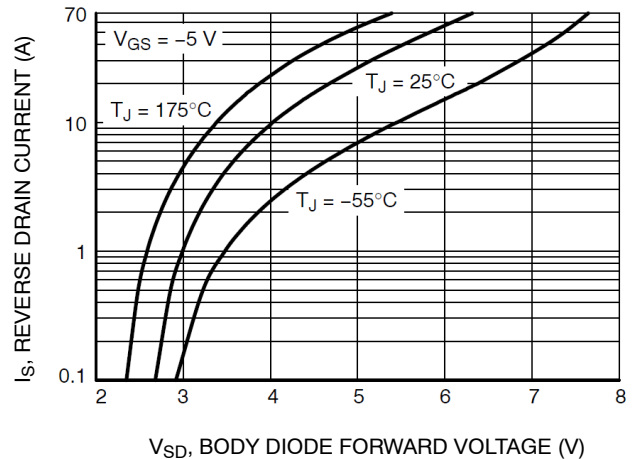

Figure 6. Diode Forward Voltage vs. Current

NVXK2VR80WDT2

TYPICAL CHARACTERISTICS (continued)

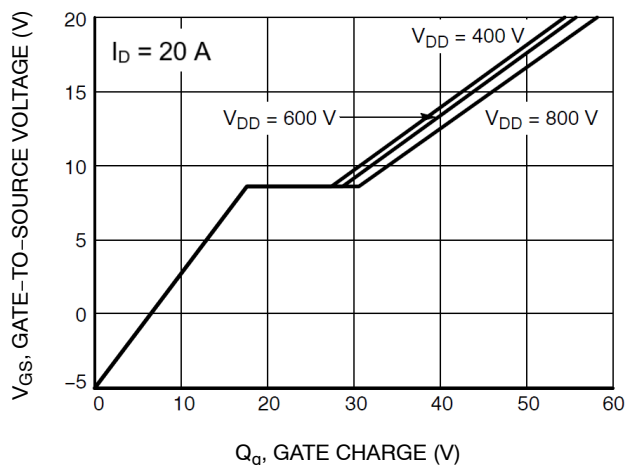

Figure 7. Gate-to-Source Voltage vs. Total Charge

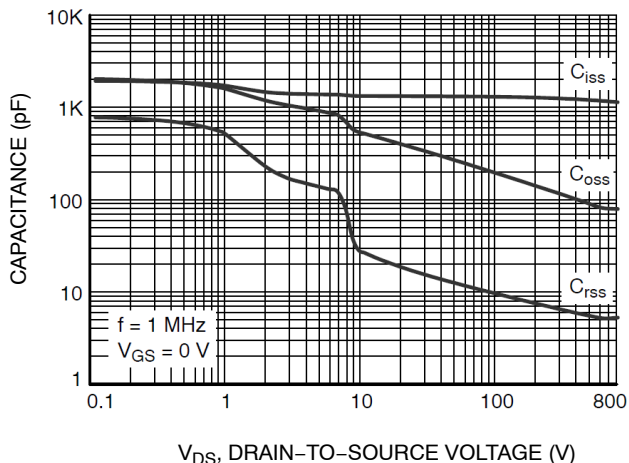

Figure 8. Capacitance vs. Drain-to-Source Voltage

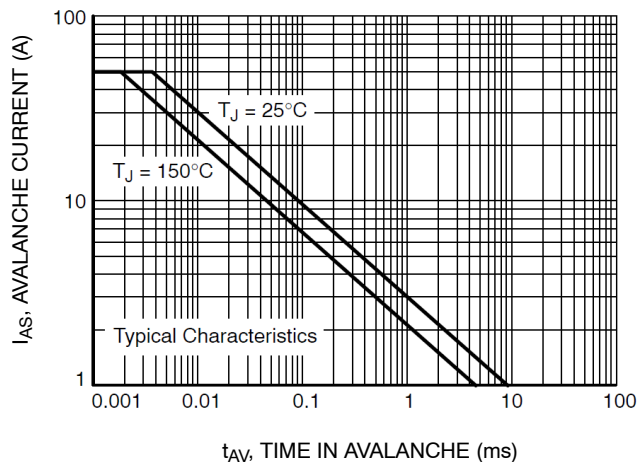

Figure 9. Unclamped Inductive Switching Capability

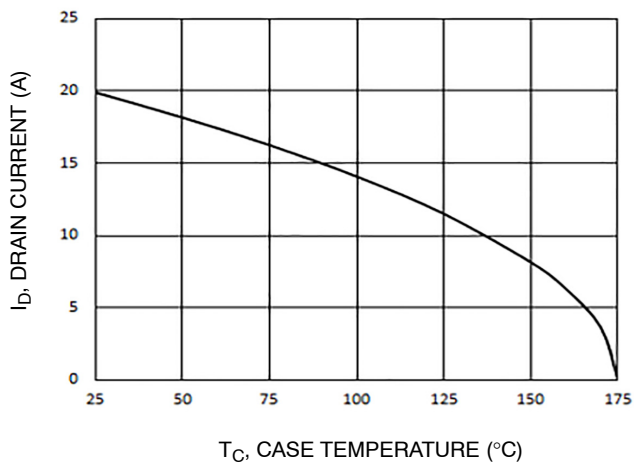

Figure 10. Maximum Continuous Drain Current vs. Case Temperature

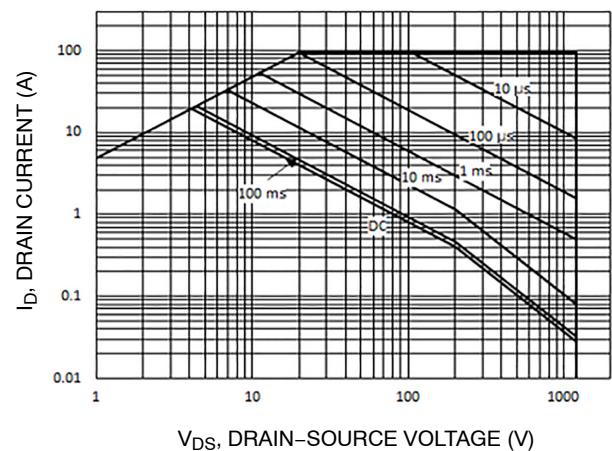

Figure 11. Safe Operating Area

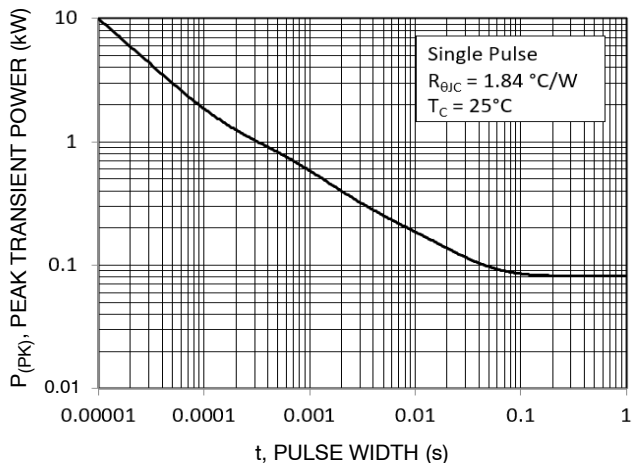

Figure 12. Single Pulse Maximum Power Dissipation

NVXK2VR80WDT2

TYPICAL CHARACTERISTICS (continued)

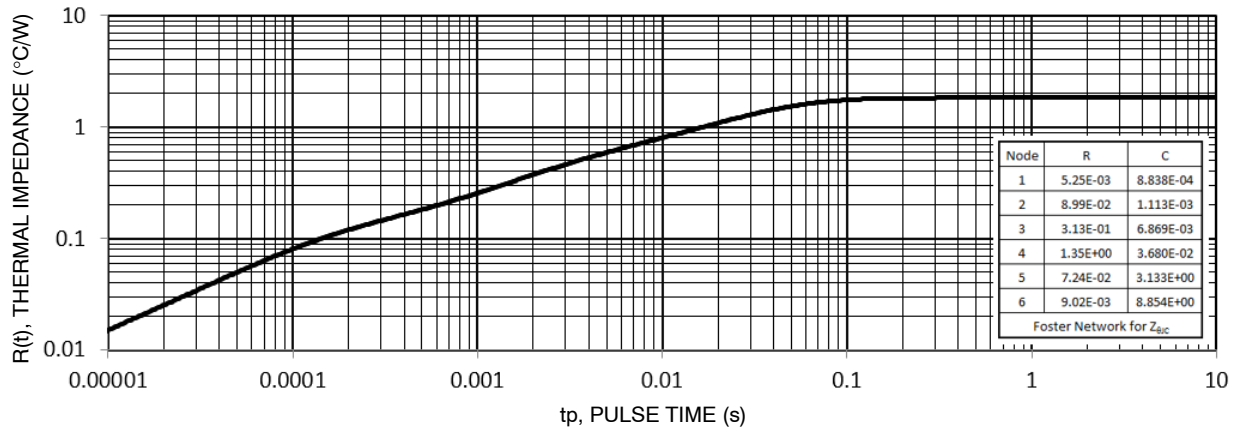
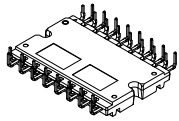

Figure 13. Thermal Response

MECHANICAL CASE OUTLINE

PACKAGE DIMENSIONS



APM32 44.00x28.80x5.70
CASE MODHM
ISSUE A

DATE 01 AUG 2023

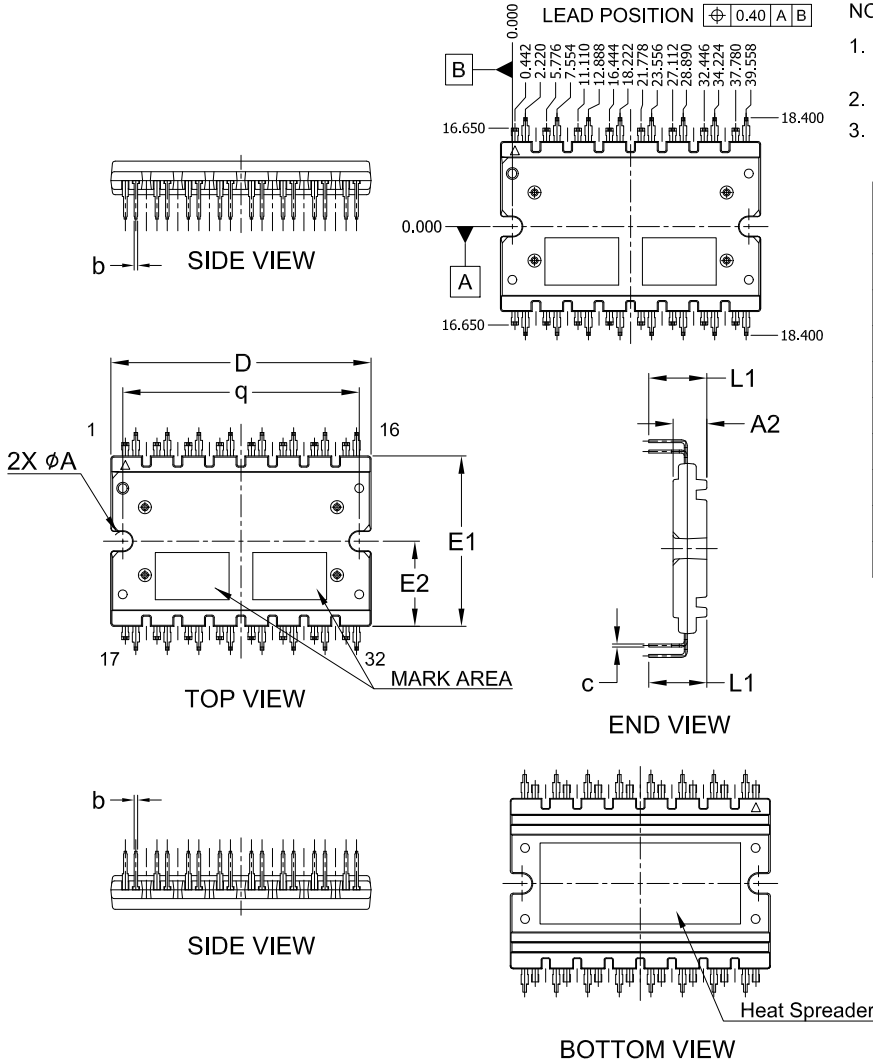

NOTES:

1. DIMENSIONING AND TOLERANCING PER ASME Y14.5M, 2009.
2. CONTROLLING DIMENSION: MILLIMETERS
3. DIMENSIONS ARE EXCLUSIVE OF BURRS, MOLD FLASH AND TIE BAR EXTRUSIONS.

DIM	MILLIMETERS		
	MIN.	NOM.	MAX.
A2	5.60	5.70	5.80
b	0.50	0.60	0.70
c	0.45	0.50	0.60
D	43.80	44.00	44.20
E1	28.60	28.80	29.00
E2	14.25	14.40	14.55
L1	9.50	9.80	10.10
q	39.85	40.00	40.15
ϕA	3.20	3.30	3.40

GENERIC MARKING DIAGRAM*

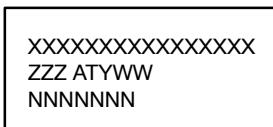

XXXX = Specific Device Code
 ZZZ = Lot ID
 AT = Assembly & Test Location
 Y = Year
 W = Work Week
 NNN = Serial Number

*This information is generic. Please refer to device data sheet for actual part marking. Pb-Free indicator, "G" or microdot "μ", may or may not be present. Some products may not follow the Generic Marking.

DOCUMENT NUMBER:	98AON29480H	Electronic versions are uncontrolled except when accessed directly from the Document Repository. Printed versions are uncontrolled except when stamped "CONTROLLED COPY" in red.
DESCRIPTION:	APM32 44.00x28.80x5.70	PAGE 1 OF 1

onsemi and ONSEMI are trademarks of Semiconductor Components Industries, LLC dba onsemi or its subsidiaries in the United States and/or other countries. onsemi reserves the right to make changes without further notice to any products herein. onsemi makes no warranty, representation or guarantee regarding the suitability of its products for any particular purpose, nor does onsemi assume any liability arising out of the application or use of any product or circuit, and specifically disclaims any and all liability, including without limitation special, consequential or incidental damages. onsemi does not convey any license under its patent rights nor the rights of others.

onsemi, **Onsemi**, and other names, marks, and brands are registered and/or common law trademarks of Semiconductor Components Industries, LLC dba "**onsemi**" or its affiliates and/or subsidiaries in the United States and/or other countries. **onsemi** owns the rights to a number of patents, trademarks, copyrights, trade secrets, and other intellectual property. A listing of **onsemi**'s product/patent coverage may be accessed at www.onsemi.com/site/pdf/Patent-Marking.pdf. **onsemi** reserves the right to make changes at any time to any products or information herein, without notice. The information herein is provided "as-is" and **onsemi** makes no warranty, representation or guarantee regarding the accuracy of the information, product features, availability, functionality, or suitability of its products for any particular purpose, nor does **onsemi** assume any liability arising out of the application or use of any product or circuit, and specifically disclaims any and all liability, including without limitation special, consequential or incidental damages. Buyer is responsible for its products and applications using **onsemi** products, including compliance with all laws, regulations and safety requirements or standards, regardless of any support or applications information provided by **onsemi**. "Typical" parameters which may be provided in **onsemi** data sheets and/or specifications can and do vary in different applications and actual performance may vary over time. All operating parameters, including "Typicals" must be validated for each customer application by customer's technical experts. **onsemi** does not convey any license under any of its intellectual property rights nor the rights of others. **onsemi** products are not designed, intended, or authorized for use as a critical component in life support systems or any FDA Class 3 medical devices or medical devices with a same or similar classification in a foreign jurisdiction or any devices intended for implantation in the human body. Should Buyer purchase or use **onsemi** products for any such unintended or unauthorized application, Buyer shall indemnify and hold **onsemi** and its officers, employees, subsidiaries, affiliates, and distributors harmless against all claims, costs, damages, and expenses, and reasonable attorney fees arising out of, directly or indirectly, any claim of personal injury or death associated with such unintended or unauthorized use, even if such claim alleges that **onsemi** was negligent regarding the design or manufacture of the part. **onsemi** is an Equal Opportunity/Affirmative Action Employer. This literature is subject to all applicable copyright laws and is not for resale in any manner.

ADDITIONAL INFORMATION

TECHNICAL PUBLICATIONS:

Technical Library: www.onsemi.com/design/resources/technical-documentation
onsemi Website: www.onsemi.com

ONLINE SUPPORT: www.onsemi.com/support

For additional information, please contact your local Sales Representative at www.onsemi.com/support/sales