

# MOSFET - Power, Single N-Channel, STD Gate, SO8-FL

40 V, 0.52 mΩ, 414 A

## NVMFWS0D5N04XM

### Features

- Low  $R_{DS(on)}$  to Minimize Conduction Losses
- Low Capacitance to Minimize Driver Losses
- Small Footprint (5 x 6 mm) with Compact Design
- AEC-Q101 Qualified and PPAP Capable
- These Devices are Pb-Free, Halogen Free/BFR Free and are RoHS Compliant

### Applications

- Motor Drive
- Battery Protection
- Synchronous Rectification

### MAXIMUM RATINGS ( $T_J = 25^\circ\text{C}$ unless otherwise noted)

Parameter	Symbol	Value	Unit
Drain-to-Source Voltage	$V_{DSS}$	40	V
Gate-to-Source Voltage	$V_{GS}$	$\pm 20$	V
Continuous Drain Current	$I_D$	$T_C = 25^\circ\text{C}$	414
		$T_C = 100^\circ\text{C}$	293
Power Dissipation	$P_D$	163	W
Pulsed Drain Current	$I_{DM}$	$T_C = 25^\circ\text{C}, t_p = 10 \mu\text{s}$	900
Pulsed Source Current (Body Diode)			$I_{SM}$
Operating Junction and Storage Temperature Range	$T_J, T_{STG}$	-55 to +175	$^\circ\text{C}$
Source Current (Body Diode)	$I_S$	251	A
Single Pulse Avalanche Energy	$I_{PK} = 28.2 \text{ A}$	$E_{AS}$	1434 mJ
Lead Temperature for Soldering Purposes (1/8" from case for 10 s)	$T_L$	260	$^\circ\text{C}$

Stresses exceeding those listed in the Maximum Ratings table may damage the device. If any of these limits are exceeded, device functionality should not be assumed, damage may occur and reliability may be affected.

$V_{(BR)DSS}$	$R_{DS(on) MAX}$	$I_D MAX$
40 V	0.52 mΩ @ 10 V	414 A

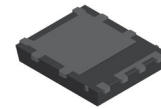
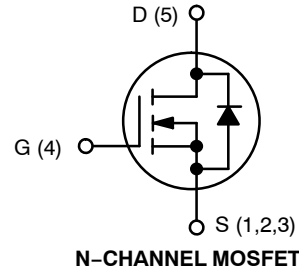

DFNW5 (SO-8FL WF)  
CASE 507BD

### MARKING DIAGRAM

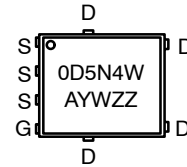

- A = Assembly Location
- Y = Year
- W = Work Week
- ZZ = Lot Traceability

### ORDERING INFORMATION

See detailed ordering, marking and shipping information in the package dimensions section on page 5 of this data sheet.

# NVMFWS0D5N04XM

## THERMAL CHARACTERISTICS

Parameter	Symbol	Value	Unit
Thermal Resistance, Junction-to-Case (Note 2)	$R_{\theta JC}$	0.92	°C/W
Thermal Resistance, Junction-to-Ambient (Notes 1, 2)	$R_{\theta JA}$	38.9	

- Surface-mounted on FR4 board using 650 mm<sup>2</sup> pad, 2 oz Cu pad.
- The entire application environment impacts the thermal resistance values shown, they are not constants and are only valid for the particular conditions noted.

## ELECTRICAL CHARACTERISTICS ( $T_J = 25^\circ\text{C}$ unless otherwise specified)

Parameter	Symbol	Test Condition	Min	Typ	Max	Unit
-----------	--------	----------------	-----	-----	-----	------

### OFF CHARACTERISTICS

Drain-to-Source Breakdown Voltage	$V_{(BR)DSS}$	$V_{GS} = 0\text{ V}, I_D = 1\text{ mA}, T_J = 25^\circ\text{C}$	40			V
Drain-to-Source Breakdown Voltage Temperature Coefficient	$\Delta V_{(BR)DSS} / \Delta T_J$	$I_D = 1\text{ mA}$ , Referenced to $25^\circ\text{C}$		15		mV/°C
Zero Gate Voltage Drain Current	$I_{DSS}$	$V_{DS} = 40\text{ V}, T_J = 25^\circ\text{C}$			1	μA
		$V_{DS} = 40\text{ V}, T_J = 125^\circ\text{C}$			60	
Gate-to-Source Leakage Current	$I_{GSS}$	$V_{GS} = 20\text{ V}, V_{DS} = 0\text{ V}$			100	nA

### ON CHARACTERISTICS

Drain-to-Source On Resistance	$R_{DS(on)}$	$V_{GS} = 10\text{ V}, I_D = 50\text{ A}, T_J = 25^\circ\text{C}$		0.43	0.52	mΩ
Gate Threshold Voltage	$V_{GS(TH)}$	$V_{GS} = V_{DS}, I_D = 240\text{ }\mu\text{A}, T_J = 25^\circ\text{C}$	2.5	3.0	3.5	V
Gate Threshold Voltage Temperature Coefficient	$\Delta V_{GS(TH)} / \Delta T_J$	$V_{GS} = V_{DS}, I_D = 240\text{ }\mu\text{A}$		-7.21		mV/°C
Forward Trans-conductance	$g_{FS}$	$V_{DS} = 5\text{ V}, I_D = 50\text{ A}$		267		S

### CHARGES, CAPACITANCES & GATE RESISTANCE

Input Capacitance	$C_{ISS}$	$V_{DS} = 25\text{ V}, V_{GS} = 0\text{ V}, f = 1\text{ MHz}$		6232		pF	
Output Capacitance	$C_{OSS}$			3987			
Reverse Transfer Capacitance	$C_{RSS}$			53.9			
Total Gate Charge	$Q_G(TOT)$	$V_{DD} = 32\text{ V}, I_D = 50\text{ A}, V_{GS} = 6\text{ V}$		60.5		nC	
Total Gate Charge	$Q_G(TOT)$		$V_{DD} = 32\text{ V}, I_D = 50\text{ A}, V_{GS} = 10\text{ V}$		97.9		
Threshold Gate Charge	$Q_G(TH)$				18.2		
Gate-to-Source Charge	$Q_{GS}$				27.4		
Gate-to-Drain Charge	$Q_{GD}$				18.5		
Gate Resistance	$R_G$			$f = 1\text{ MHz}$			0.47

### SWITCHING CHARACTERISTICS

Turn-On Delay Time	$t_{d(ON)}$	Resistive Load, $V_{GS} = 0/10\text{ V}$ , $V_{DD} = 32\text{ V}, I_D = 50\text{ A}, R_G = 0\text{ }\Omega$		8.64		ns
Rise Time	$t_r$			7.02		
Turn-Off Delay Time	$t_{d(OFF)}$			13.7		
Fall Time	$t_f$			6.85		

### SOURCE-TO-DRAIN DIODE CHARACTERISTICS

Forward Diode Voltage	$V_{SD}$	$I_S = 50\text{ A}, V_{GS} = 0\text{ V}, T_J = 25^\circ\text{C}$		0.8	1.2	V
		$I_S = 50\text{ A}, V_{GS} = 0\text{ V}, T_J = 125^\circ\text{C}$		0.65		
Reverse Recovery Time	$t_{RR}$	$V_{GS} = 0\text{ V}, I_S = 50\text{ A}$ , $dI/dt = 100\text{ A}/\mu\text{s}, V_{DD} = 32\text{ V}$		101		ns
Charge Time	$t_a$			56.9		
Discharge Time	$t_b$			44.8		
Reverse Recovery Charge	$Q_{RR}$			286		

Product parametric performance is indicated in the Electrical Characteristics for the listed test conditions, unless otherwise noted. Product performance may not be indicated by the Electrical Characteristics if operated under different conditions.

TYPICAL CHARACTERISTICS

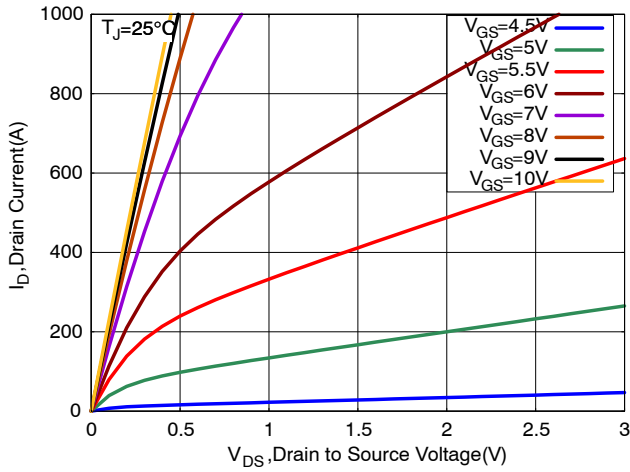

Figure 1. On-Region Characteristics

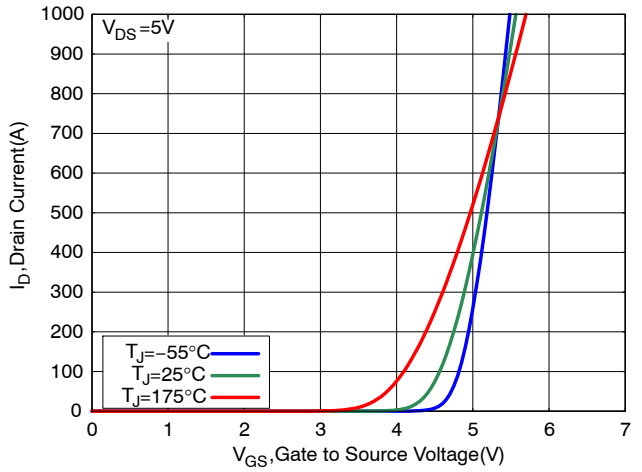

Figure 2. Transfer Characteristics

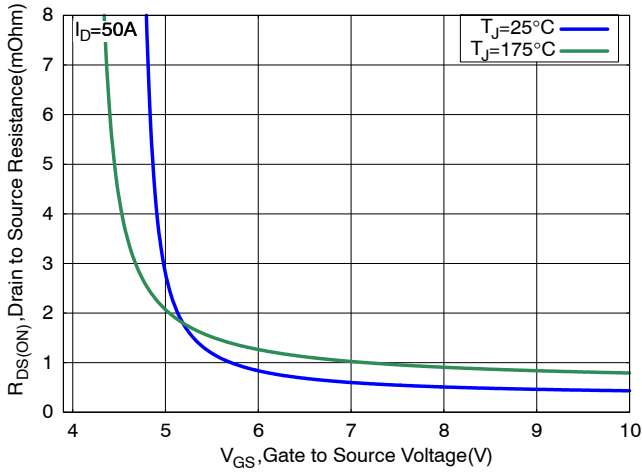

Figure 3. On-Resistance vs. Gate Voltage

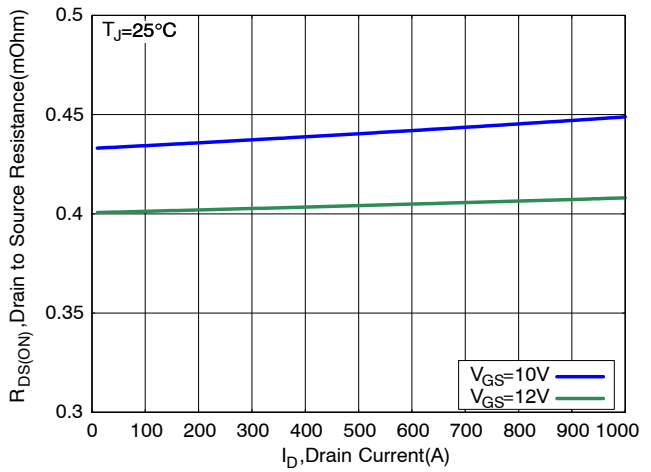

Figure 4. On-Resistance vs. Drain Current

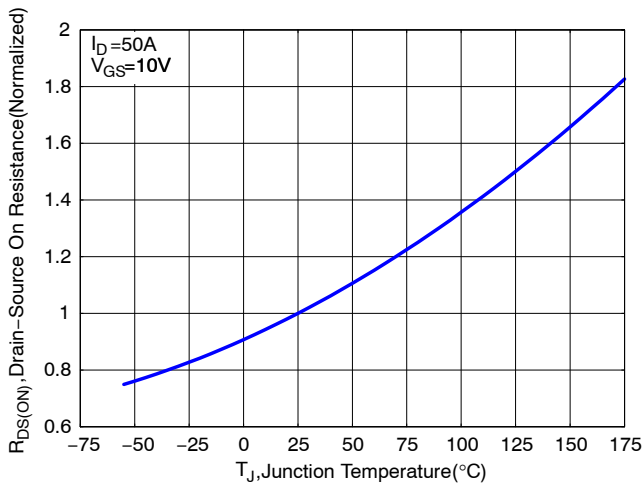

Figure 5. Normalized ON Resistance vs. Junction Temperature

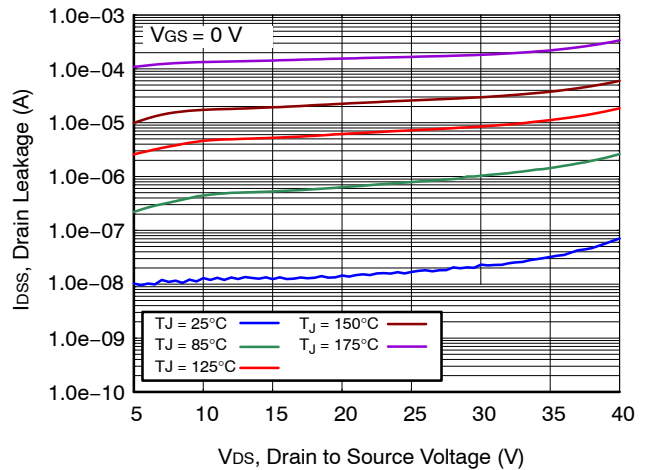

Figure 6. Drain Leakage vs. Drain to Source Voltage

# NVMFWS0D5N04XM

## TYPICAL CHARACTERISTICS (continued)

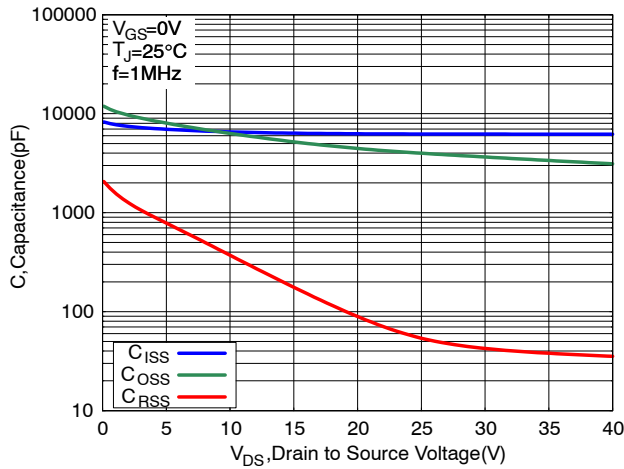

Figure 7. Capacitance Characteristics

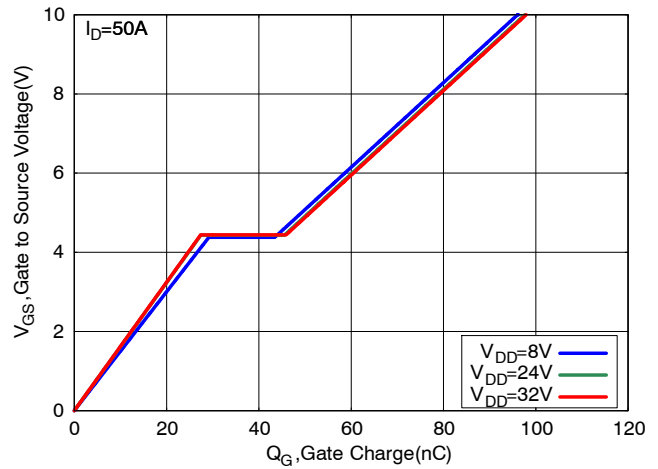

Figure 8. Gate Charge Characteristics

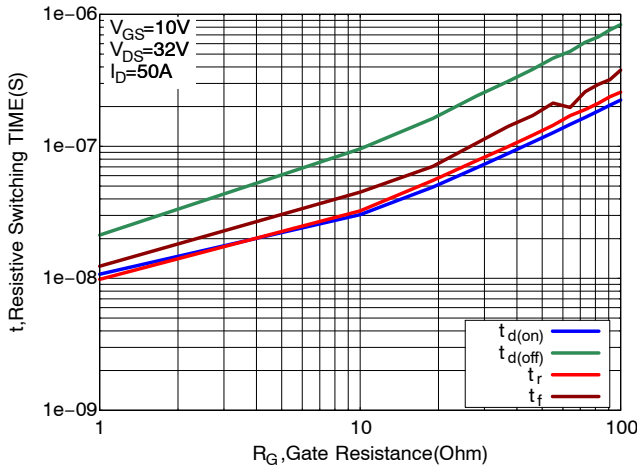

Figure 9. Resistive Switching Time Variation vs. Gate Resistance

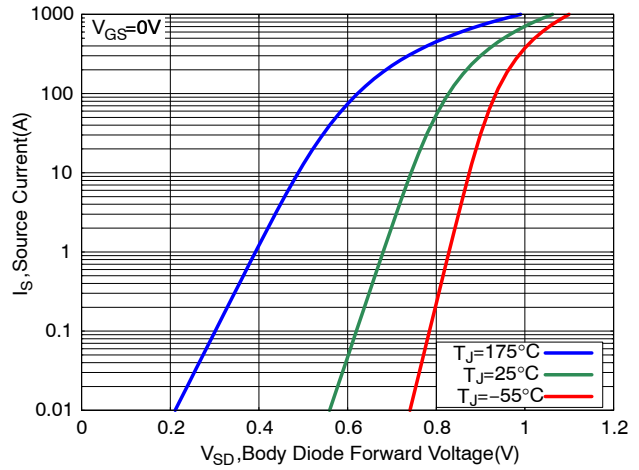

Figure 10. Diode Forward Characteristics

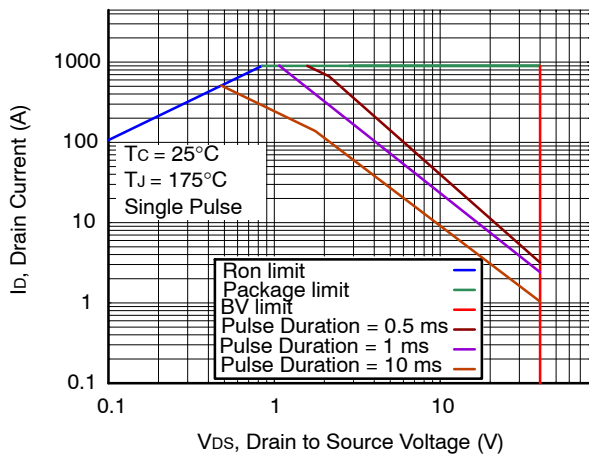

Figure 11. Maximum Rated Forward Biased Safe Operating Area

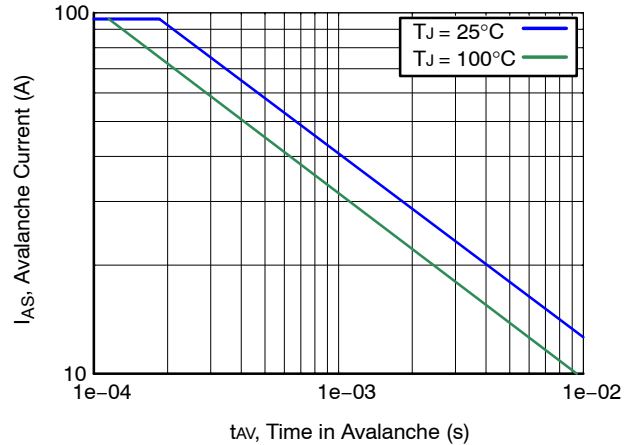

Figure 12.  $I_{peak}$  vs. Time in Avalanche

# NVMFWS0D5N04XM

## TYPICAL CHARACTERISTICS (continued)

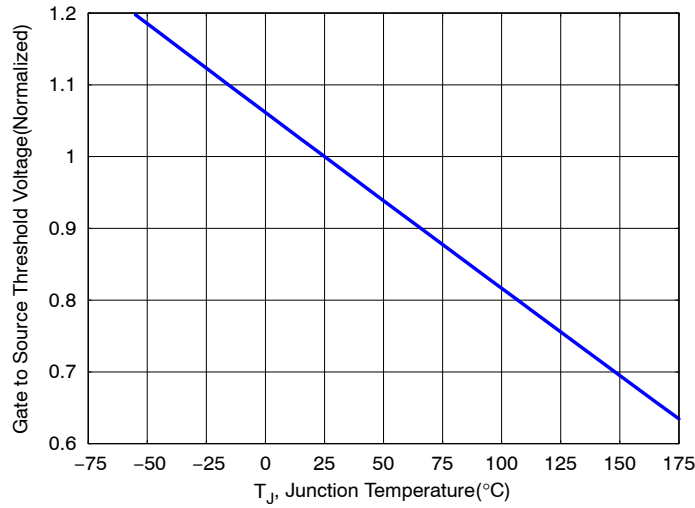

Figure 13. Gate Threshold Voltage vs. Junction Temperature

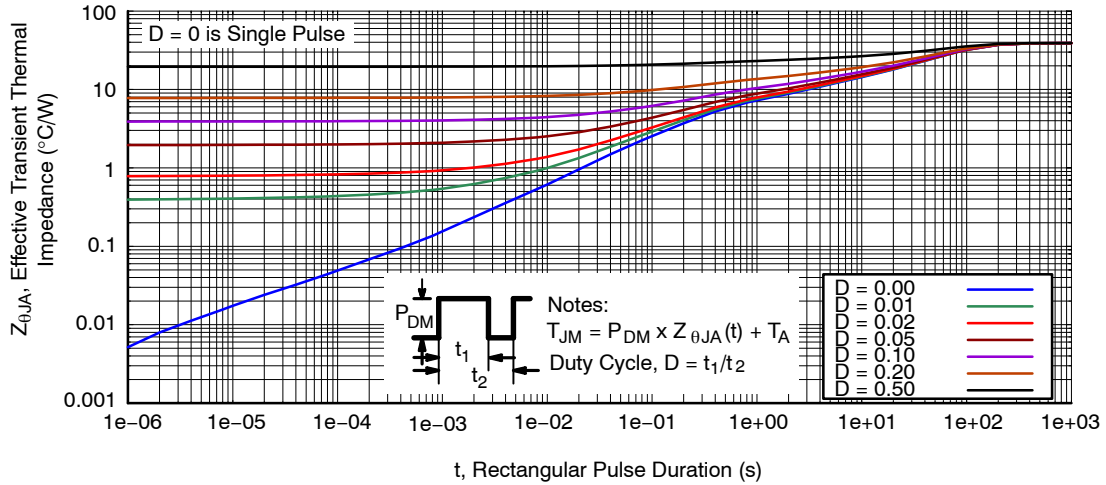

Figure 14. Thermal Characteristics

### DEVICE ORDERING INFORMATION

Device	Marking	Package	Shipping <sup>†</sup>
NVMFWS0D5N04XMT1G	0D5N4W	DFNW5 (Pb-Free)	1500 / Tape & Reel

<sup>†</sup>For information on tape and reel specifications, including part orientation and tape sizes, please refer to our Tape and Reel Packaging Specifications Brochure, BRD8011/D.

# MECHANICAL CASE OUTLINE

## PACKAGE DIMENSIONS

ON Semiconductor®

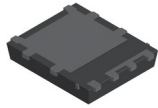

### DFNW5 5x6, FULL-CUT SO8FL WF CASE 507BD ISSUE O

DATE 13 APR 2021

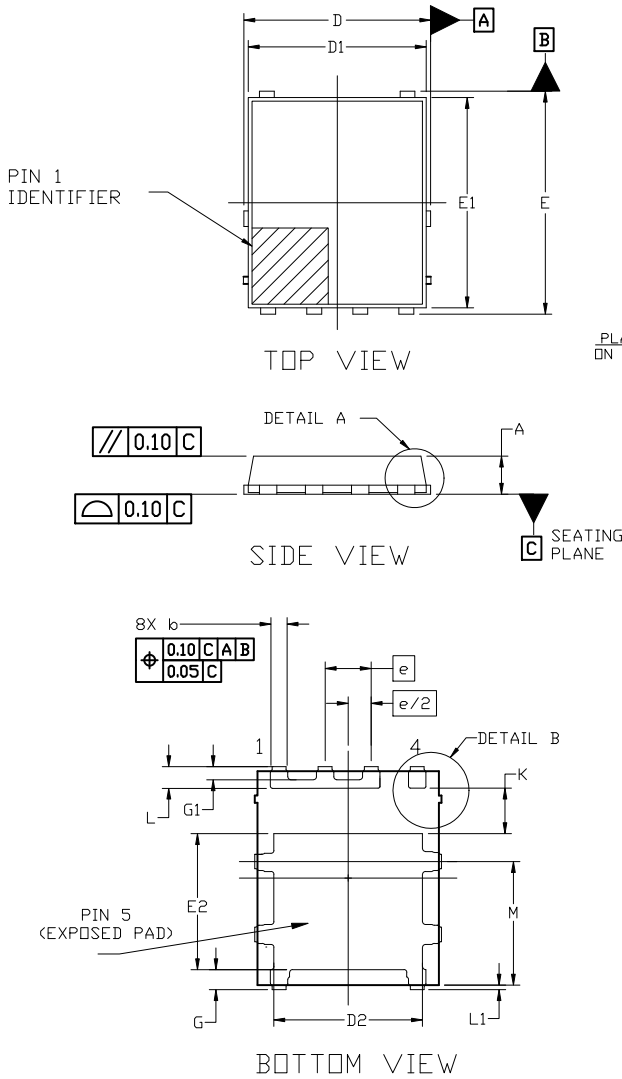

**NOTES:**

1. DIMENSIONING AND TOLERANCING PER ASME Y14.5M, 2009.
2. CONTROLLING DIMENSION: MILLIMETERS
3. DIMENSIONS D1 AND E1 DO NOT INCLUDE MOLD FLASH, PROTRUSIONS, OR GATE BURRS.
4. THIS PACKAGE CONTAINS WETTABLE FLANK DESIGN FEATURES TO AID IN FILLET FORMATION ON THE LEADS DURING MOUNTING.

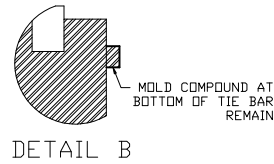
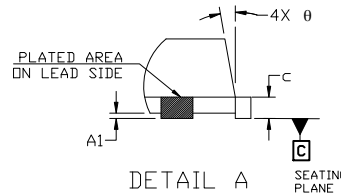

DIM	MILLIMETERS		
	MIN.	NOM.	MAX.
A	0.90	1.00	1.10
A1	0.00	---	0.05
b	0.33	0.41	0.51
c	0.23	0.28	0.33
D	5.00	5.15	5.30
D1	4.80	5.00	5.20
D2	3.90	4.10	4.30
E	6.00	6.15	6.30
E1	5.70	5.90	6.10
E2	3.55	3.75	3.95
e	1.27 BSC		
G	0.50	0.55	0.70
G1	0.26	0.36	0.46
k	1.10	1.25	1.40
L	0.50	0.60	0.70
L1	0.150 REF		
M	3.00	3.40	3.80
θ	0°	---	12°

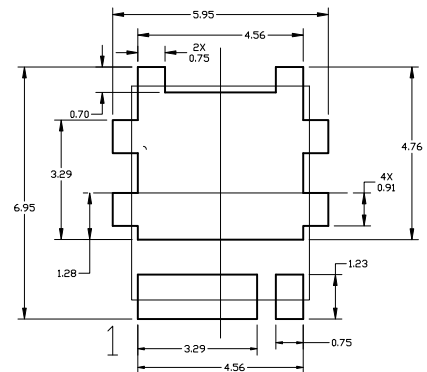

**RECOMMENDED MOUNTING FOOTPRINT**

\* For additional information on our Pb-Free strategy and soldering details, please download the ON Semiconductor Soldering and Mounting Techniques Reference Manual, SOLDERM/D.

**GENERIC MARKING DIAGRAM\***

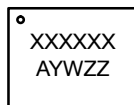

- XXXX = Specific Device Code
- A = Assembly Location
- Y = Year
- W = Work Week
- ZZ = Assembly Lot

\*This information is generic. Please refer to device data sheet for actual part marking. Pb-Free indicator, "G" or microdot "•", may or may not be present. Some products may not follow the Generic Marking.

<b>DOCUMENT NUMBER:</b>	<b>98AON31027H</b>	Electronic versions are uncontrolled except when accessed directly from the Document Repository. Printed versions are uncontrolled except when stamped "CONTROLLED COPY" in red.
<b>DESCRIPTION:</b>	<b>DFNW5 5x6, FULL-CUT SO8FL WF</b>	<b>PAGE 1 OF 1</b>

ON Semiconductor and ON are trademarks of Semiconductor Components Industries, LLC dba ON Semiconductor or its subsidiaries in the United States and/or other countries. ON Semiconductor reserves the right to make changes without further notice to any products herein. ON Semiconductor makes no warranty, representation or guarantee regarding the suitability of its products for any particular purpose, nor does ON Semiconductor assume any liability arising out of the application or use of any product or circuit, and specifically disclaims any and all liability, including without limitation special, consequential or incidental damages. ON Semiconductor does not convey any license under its patent rights nor the rights of others.

**onsemi**, **Onsemi**, and other names, marks, and brands are registered and/or common law trademarks of Semiconductor Components Industries, LLC dba "**onsemi**" or its affiliates and/or subsidiaries in the United States and/or other countries. **onsemi** owns the rights to a number of patents, trademarks, copyrights, trade secrets, and other intellectual property. A listing of **onsemi**'s product/patent coverage may be accessed at [www.onsemi.com/site/pdf/Patent-Marking.pdf](http://www.onsemi.com/site/pdf/Patent-Marking.pdf). **onsemi** reserves the right to make changes at any time to any products or information herein, without notice. The information herein is provided "as-is" and **onsemi** makes no warranty, representation or guarantee regarding the accuracy of the information, product features, availability, functionality, or suitability of its products for any particular purpose, nor does **onsemi** assume any liability arising out of the application or use of any product or circuit, and specifically disclaims any and all liability, including without limitation special, consequential or incidental damages. Buyer is responsible for its products and applications using **onsemi** products, including compliance with all laws, regulations and safety requirements or standards, regardless of any support or applications information provided by **onsemi**. "Typical" parameters which may be provided in **onsemi** data sheets and/or specifications can and do vary in different applications and actual performance may vary over time. All operating parameters, including "Typicals" must be validated for each customer application by customer's technical experts. **onsemi** does not convey any license under any of its intellectual property rights nor the rights of others. **onsemi** products are not designed, intended, or authorized for use as a critical component in life support systems or any FDA Class 3 medical devices or medical devices with a same or similar classification in a foreign jurisdiction or any devices intended for implantation in the human body. Should Buyer purchase or use **onsemi** products for any such unintended or unauthorized application, Buyer shall indemnify and hold **onsemi** and its officers, employees, subsidiaries, affiliates, and distributors harmless against all claims, costs, damages, and expenses, and reasonable attorney fees arising out of, directly or indirectly, any claim of personal injury or death associated with such unintended or unauthorized use, even if such claim alleges that **onsemi** was negligent regarding the design or manufacture of the part. **onsemi** is an Equal Opportunity/Affirmative Action Employer. This literature is subject to all applicable copyright laws and is not for resale in any manner.

## ADDITIONAL INFORMATION

### TECHNICAL PUBLICATIONS:

Technical Library: [www.onsemi.com/design/resources/technical-documentation](http://www.onsemi.com/design/resources/technical-documentation)  
onsemi Website: [www.onsemi.com](http://www.onsemi.com)

### ONLINE SUPPORT: [www.onsemi.com/support](http://www.onsemi.com/support)

For additional information, please contact your local Sales Representative at [www.onsemi.com/support/sales](http://www.onsemi.com/support/sales)