

MOSFET – Power, Single N-Channel

40 V, 1.0 mΩ, 277 A

NVMFS5C420NL

Features

- Small Footprint (5x6 mm) for Compact Design
- Low $R_{DS(on)}$ to Minimize Conduction Losses
- Low Q_G and Capacitance to Minimize Driver Losses
- NVMFS5C420NLWF – Wettable Flank Option for Enhanced Optical Inspection
- AEC-Q101 Qualified and PPAP Capable
- These Devices are Pb-Free and are RoHS Compliant

MAXIMUM RATINGS ($T_J = 25^\circ\text{C}$ unless otherwise noted)

Parameter	Symbol	Value	Unit
Drain-to-Source Voltage	V_{DSS}	40	V
Gate-to-Source Voltage	V_{GS}	± 20	V
Continuous Drain Current $R_{\theta JC}$ (Notes 1, 3)	Steady State	$T_C = 25^\circ\text{C}$	I_D 277 A
		$T_C = 100^\circ\text{C}$	196
Power Dissipation $R_{\theta JC}$ (Note 1)	Steady State	$T_C = 25^\circ\text{C}$	P_D 146 W
		$T_C = 100^\circ\text{C}$	73
Continuous Drain Current $R_{\theta JA}$ (Notes 1, 2, 3)	Steady State	$T_A = 25^\circ\text{C}$	I_D 45 A
		$T_A = 100^\circ\text{C}$	32
Power Dissipation $R_{\theta JA}$ (Notes 1, 2)	Steady State	$T_A = 25^\circ\text{C}$	P_D 3.8 W
		$T_A = 100^\circ\text{C}$	1.9
Pulsed Drain Current	$T_A = 25^\circ\text{C}, t_p = 10 \mu\text{s}$	I_{DM} 900	A
Operating Junction and Storage Temperature Range	T_J, T_{stg}	-55 to +175	$^\circ\text{C}$
Source Current (Body Diode)	I_S	121.4	A
Single Pulse Drain-to-Source Avalanche Energy ($I_{L(pk)} = 24 \text{ A}$)	E_{AS}	1541	mJ
Lead Temperature for Soldering Purposes (1/8" from case for 10 s)	T_L	260	$^\circ\text{C}$

Stresses exceeding those listed in the Maximum Ratings table may damage the device. If any of these limits are exceeded, device functionality should not be assumed, damage may occur and reliability may be affected.

THERMAL RESISTANCE MAXIMUM RATINGS

Parameter	Symbol	Value	Unit
Junction-to-Case – Steady State	$R_{\theta JC}$	1.0	$^\circ\text{C}/\text{W}$
Junction-to-Ambient – Steady State (Note 2)	$R_{\theta JA}$	39	

1. The entire application environment impacts the thermal resistance values shown, they are not constants and are only valid for the particular conditions noted.
2. Surface-mounted on FR4 board using a 650 mm², 2 oz. Cu pad.
3. Maximum current for pulses as long as 1 second is higher but is dependent on pulse duration and duty cycle.

$V_{(BR)DSS}$	$R_{DS(ON) MAX}$	$I_D MAX$
40 V	1.0 mΩ @ 10 V	277 A
	1.4 mΩ @ 4.5 V	

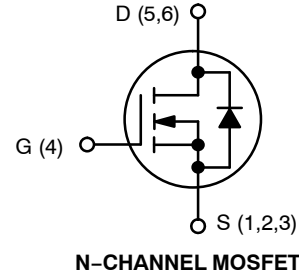

DFN5 (SO-8FL) CASE 488AA STYLE 1

MARKING DIAGRAM

DFNW5 (SO-8FL) CASE 507BA

XXXXXX = 5C420L
(NVMFS5C420NL) or 420LWF
(NVMFS5C420NLWF)

A = Assembly Location
Y = Year
W = Work Week
ZZ = Lot Traceability

ORDERING INFORMATION

See detailed ordering, marking and shipping information on page 5 of this data sheet.

NVMFS5C420NL

ELECTRICAL CHARACTERISTICS ($T_J = 25^\circ\text{C}$ unless otherwise specified)

Parameter	Symbol	Test Condition	Min	Typ	Max	Unit
OFF CHARACTERISTICS						
Drain-to-Source Breakdown Voltage	$V_{(BR)DSS}$	$V_{GS} = 0\text{ V}, I_D = 250\ \mu\text{A}$	40			V
Drain-to-Source Breakdown Voltage Temperature Coefficient	$V_{(BR)DSS}/T_J$			18.5		mV/ $^\circ\text{C}$
Zero Gate Voltage Drain Current	I_{DSS}	$V_{GS} = 0\text{ V}, V_{DS} = 40\text{ V}$	$T_J = 25^\circ\text{C}$		10	μA
			$T_J = 125^\circ\text{C}$		100	
Gate-to-Source Leakage Current	I_{GSS}	$V_{DS} = 0\text{ V}, V_{GS} = 20\text{ V}$			100	nA

ON CHARACTERISTICS (Note 4)

Gate Threshold Voltage	$V_{GS(TH)}$	$V_{GS} = V_{DS}, I_D = 200\ \mu\text{A}$	1.2		2.2	V
Threshold Temperature Coefficient	$V_{GS(TH)}/T_J$			-5.4		mV/ $^\circ\text{C}$
Drain-to-Source On Resistance	$R_{DS(on)}$	$V_{GS} = 4.5\text{ V}, I_D = 50\text{ A}$		1.2	1.4	m Ω
Drain-to-Source On Resistance	$R_{DS(on)}$	$V_{GS} = 10\text{ V}, I_D = 50\text{ A}$		0.8	1.0	m Ω
Forward Transconductance	g_{FS}	$V_{DS} = 5\text{ V}, I_D = 50\text{ A}$		180		S

CHARGES, CAPACITANCES & GATE RESISTANCE

Input Capacitance	C_{ISS}	$V_{GS} = 0\text{ V}, f = 1\text{ MHz}, V_{DS} = 20\text{ V}$		7020		μF
Output Capacitance	C_{OSS}			3130		
Reverse Transfer Capacitance	C_{RSS}			95		
Total Gate Charge	$Q_{G(TOT)}$	$V_{GS} = 4.5\text{ V}, V_{DS} = 32\text{ V}, I_D = 50\text{ A}$		47		nC
Total Gate Charge	$Q_{G(TOT)}$	$V_{GS} = 10\text{ V}, V_{DS} = 32\text{ V}, I_D = 50\text{ A}$		100		nC
Threshold Gate Charge	$Q_{G(TH)}$	$V_{GS} = 10\text{ V}, V_{DS} = 32\text{ V}, I_D = 50\text{ A}$		8.7		
Gate-to-Source Charge	Q_{GS}			16		
Gate-to-Drain Charge	Q_{GD}			14		
Plateau Voltage	V_{GP}			2.8		V

SWITCHING CHARACTERISTICS (Note 5)

Turn-On Delay Time	$t_{d(ON)}$	$V_{GS} = 4.5\text{ V}, V_{DS} = 32\text{ V}, I_D = 50\text{ A}, R_G = 2.5\ \Omega$		37		ns
Rise Time	t_r			46		
Turn-Off Delay Time	$t_{d(OFF)}$			76		
Fall Time	t_f			31		

DRAIN-SOURCE DIODE CHARACTERISTICS

Forward Diode Voltage	V_{SD}	$V_{GS} = 0\text{ V}, I_S = 50\text{ A}$	$T_J = 25^\circ\text{C}$		0.8	1.2	V
			$T_J = 125^\circ\text{C}$		0.65		
Reverse Recovery Time	t_{RR}	$V_{GS} = 0\text{ V}, dI_S/dt = 100\text{ A}/\mu\text{s}, I_S = 50\text{ A}$		75		ns	
Charge Time	t_a			37			
Discharge Time	t_b			38			
Reverse Recovery Charge	Q_{RR}			96			nC

Product parametric performance is indicated in the Electrical Characteristics for the listed test conditions, unless otherwise noted. Product performance may not be indicated by the Electrical Characteristics if operated under different conditions.

4. Pulse Test: pulse width $\leq 300\ \mu\text{s}$, duty cycle $\leq 2\%$.

5. Switching characteristics are independent of operating junction temperatures.

NVMFS5C420NL

TYPICAL CHARACTERISTICS

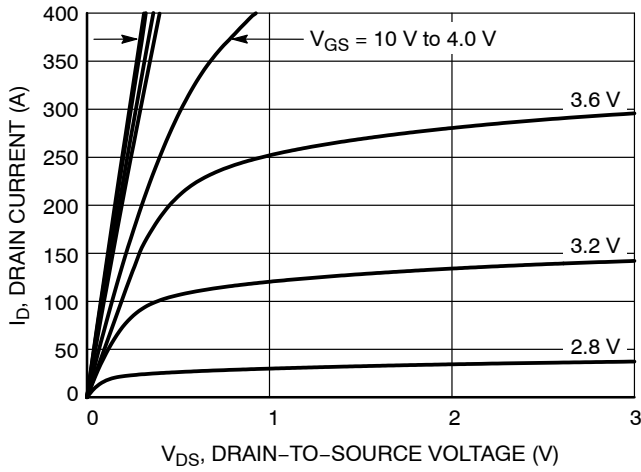

Figure 1. On-Region Characteristics

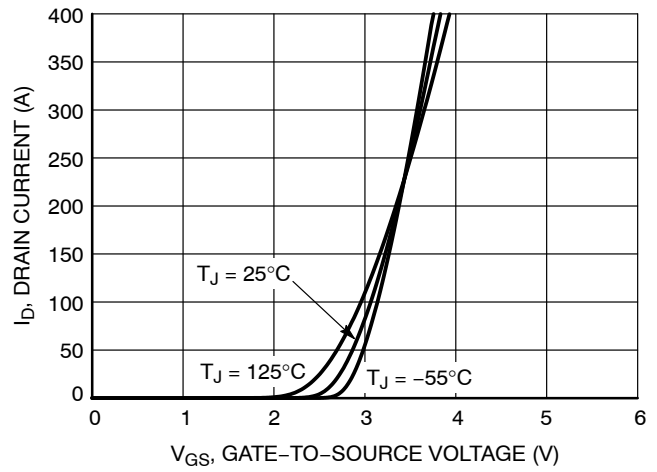

Figure 2. Transfer Characteristics

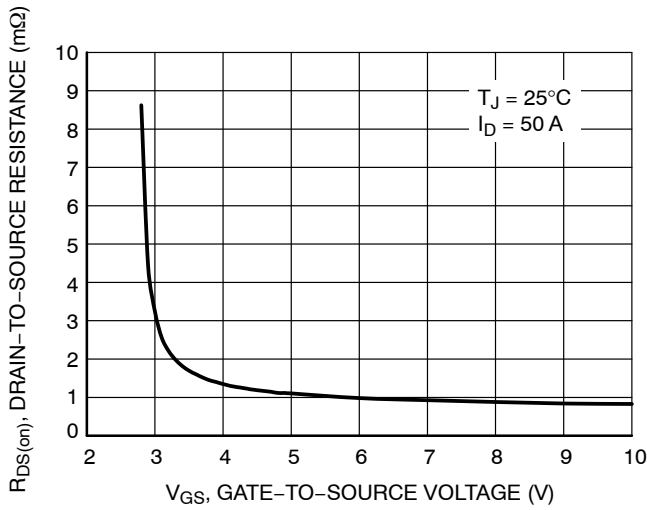

Figure 3. On-Resistance vs. Gate-to-Source Voltage

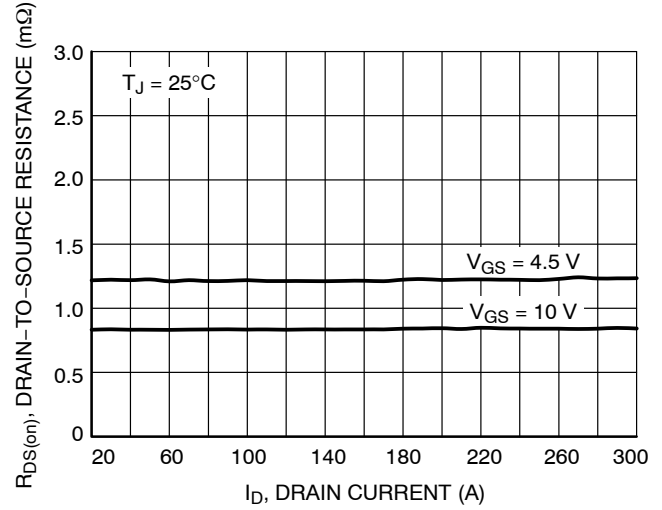

Figure 4. On-Resistance vs. Drain Current and Gate Voltage

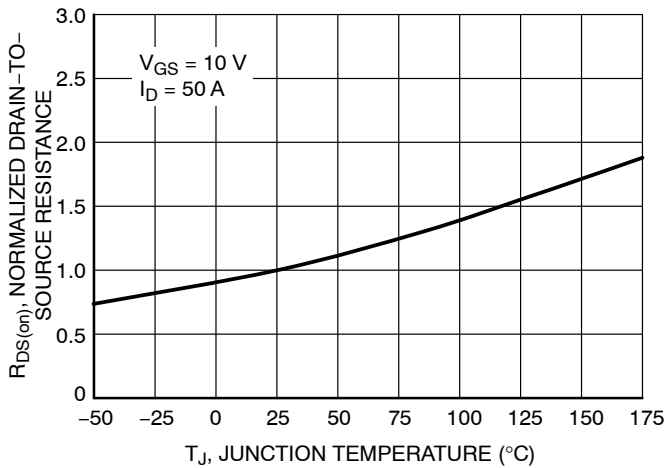

Figure 5. On-Resistance Variation with Temperature

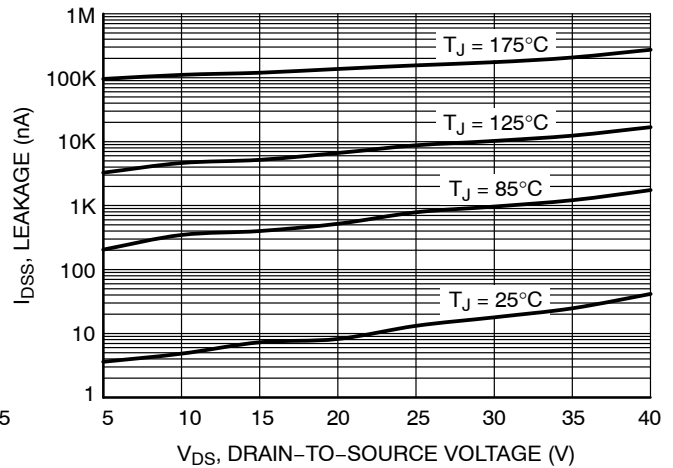

Figure 6. Drain-to-Source Leakage Current vs. Voltage

NVMFS5C420NL

TYPICAL CHARACTERISTICS

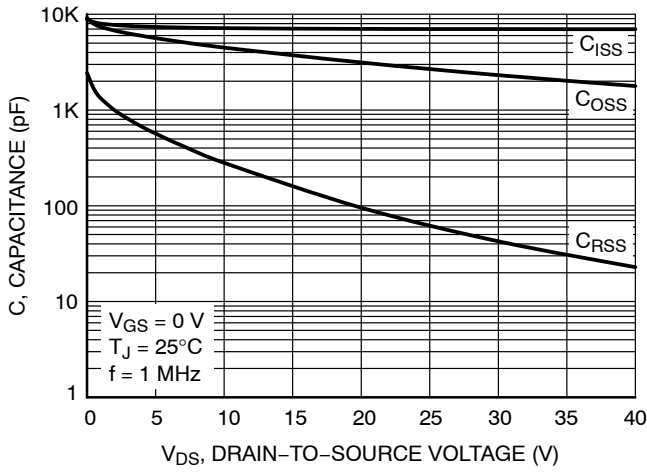

Figure 7. Capacitance Variation

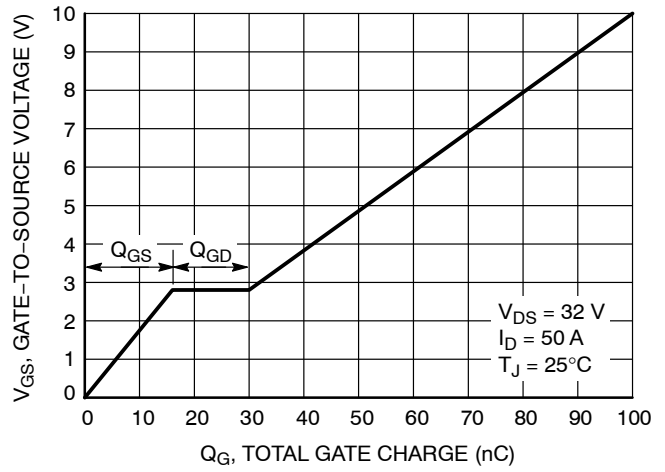

Figure 8. Gate-to-Source vs. Total Charge

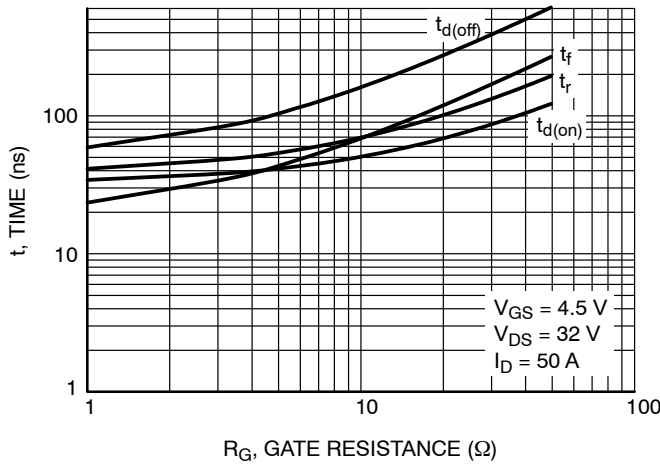

Figure 9. Resistive Switching Time Variation vs. Gate Resistance

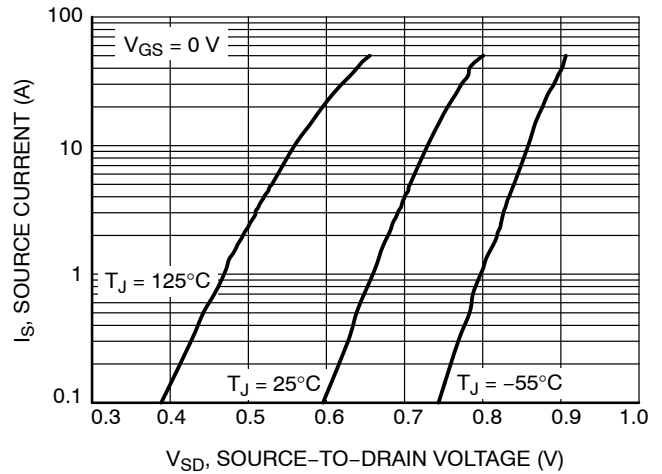

Figure 10. Diode Forward Voltage vs. Current

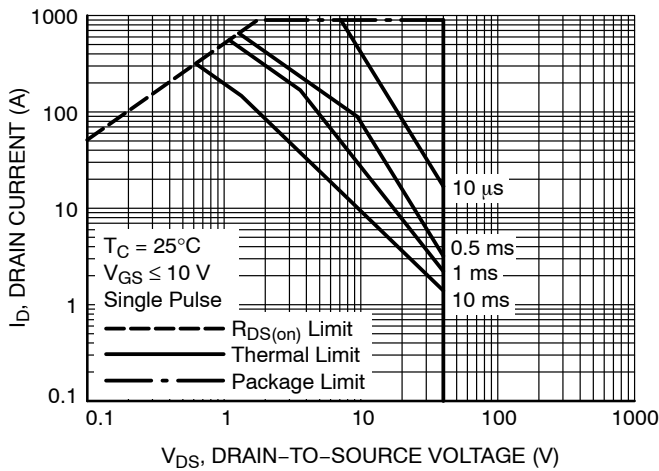

Figure 11. Maximum Rated Forward Biased Safe Operating Area

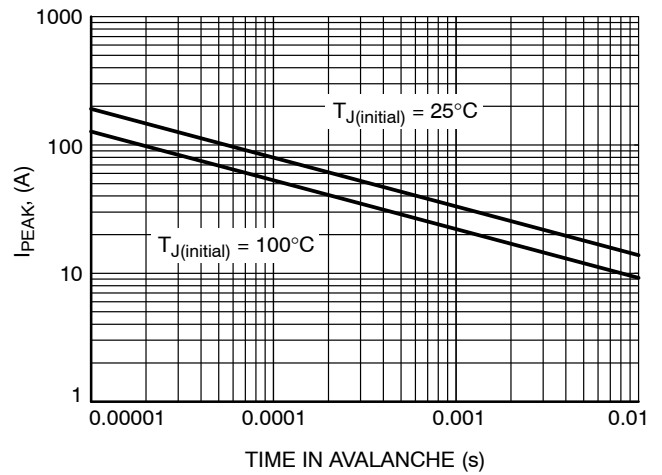

Figure 12. I_{PEAK} vs. Time in Avalanche

NVMFS5C420NL

TYPICAL CHARACTERISTICS

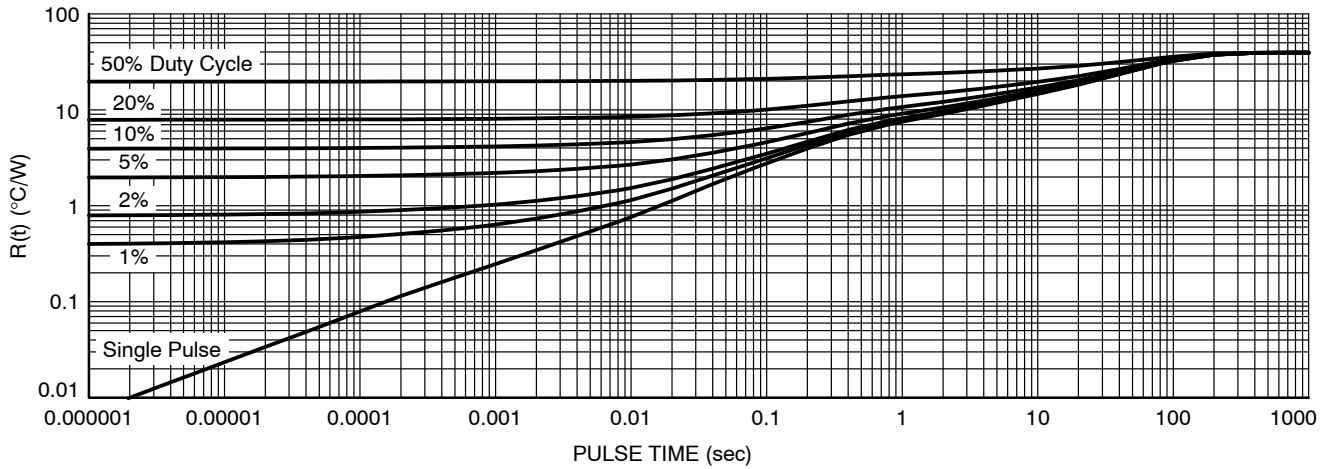

Figure 13. Thermal Characteristics

DEVICE ORDERING INFORMATION

Device	Marking	Package	Shipping [†]
NVMFS5C420NLT1G	5C420L	DFN5 (Pb-Free)	1500 / Tape & Reel
NVMFS5C420NLWFT1G	420LWF	DFNW5 (Pb-Free, Wettable Flanks)	1500 / Tape & Reel

[†]For information on tape and reel specifications, including part orientation and tape sizes, please refer to our Tape and Reel Packaging Specifications Brochure, BRD8011/D.

MECHANICAL CASE OUTLINE

PACKAGE DIMENSIONS

ON Semiconductor®



1
SCALE 2:1

DFN5 5x6, 1.27P
(SO-8FL)
CASE 488AA
ISSUE N

DATE 25 JUN 2018



NOTES:

1. DIMENSIONING AND TOLERANCING PER ASME Y14.5M, 1994.
2. CONTROLLING DIMENSION: MILLIMETER.
3. DIMENSION D1 AND E1 DO NOT INCLUDE MOLD FLASH PROTRUSIONS OR GATE BURRS.

MILLIMETERS			
DIM	MIN	NOM	MAX
A	0.90	1.00	1.10
A1	0.00	---	0.05
b	0.33	0.41	0.51
c	0.23	0.28	0.33
D	5.00	5.15	5.30
D1	4.70	4.90	5.10
D2	3.80	4.00	4.20
E	6.00	6.15	6.30
E1	5.70	5.90	6.10
E2	3.45	3.65	3.85
e	1.27 BSC		
G	0.51	0.575	0.71
K	1.20	1.35	1.50
L	0.51	0.575	0.71
L1	0.125 REF		
M	3.00	3.40	3.80
θ	0°	---	12°

GENERIC MARKING DIAGRAM*



- XXXXXX = Specific Device Code
- A = Assembly Location
- Y = Year
- W = Work Week
- ZZ = Lot Traceability

*This information is generic. Please refer to device data sheet for actual part marking. Pb-Free indicator, "G" or microdot "•", may or may not be present. Some products may not follow the Generic Marking.

RECOMMENDED SOLDERING FOOTPRINT*



- STYLE 1:
PIN 1. SOURCE
2. SOURCE
3. SOURCE
4. GATE
5. DRAIN
- STYLE 2:
PIN 1. ANODE
2. ANODE
3. ANODE
4. NO CONNECT
5. CATHODE

*For additional information on our Pb-Free strategy and soldering details, please download the ON Semiconductor Soldering and Mounting Techniques Reference Manual, SOLDERRM/D.

DOCUMENT NUMBER:	98AON14036D	Electronic versions are uncontrolled except when accessed directly from the Document Repository. Printed versions are uncontrolled except when stamped "CONTROLLED COPY" in red.
DESCRIPTION:	DFN5 5x6, 1.27P (SO-8FL)	PAGE 1 OF 1

ON Semiconductor and ON are trademarks of Semiconductor Components Industries, LLC dba ON Semiconductor or its subsidiaries in the United States and/or other countries. ON Semiconductor reserves the right to make changes without further notice to any products herein. ON Semiconductor makes no warranty, representation or guarantee regarding the suitability of its products for any particular purpose, nor does ON Semiconductor assume any liability arising out of the application or use of any product or circuit, and specifically disclaims any and all liability, including without limitation special, consequential or incidental damages. ON Semiconductor does not convey any license under its patent rights nor the rights of others.

MECHANICAL CASE OUTLINE

PACKAGE DIMENSIONS

ON Semiconductor®

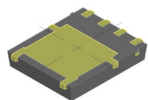

DFNW5 5x6 (FULL-CUT SO8FL WF)

CASE 507BA

ISSUE A

DATE 03 FEB 2021

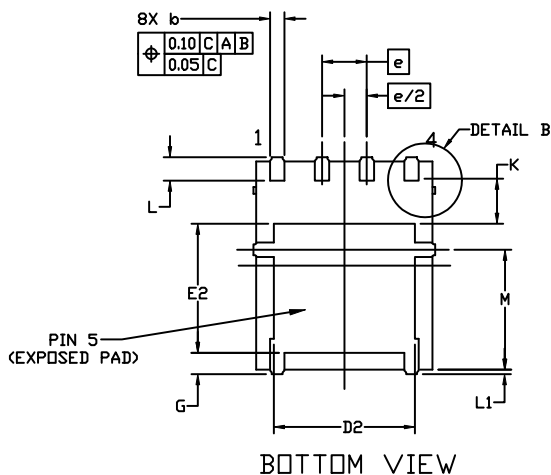
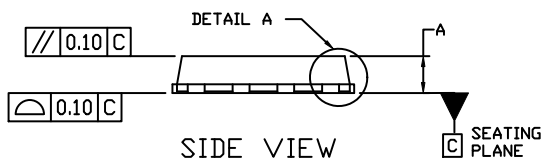
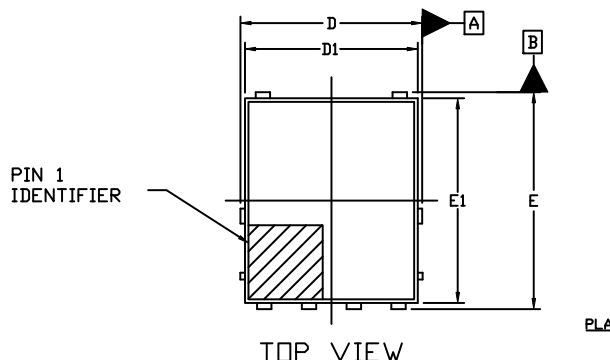

- NOTES:
1. DIMENSIONING AND TOLERANCING PER ASME Y14.5M, 2009.
 2. CONTROLLING DIMENSION: MILLIMETERS
 3. DIMENSIONS D1 AND E1 DO NOT INCLUDE MOLD FLASH, PROTRUSIONS, OR GATE BURRS.
 4. THIS PACKAGE CONTAINS WETTABLE FLANK DESIGN FEATURES TO AID IN FILLET FORMATION ON THE LEADS DURING MOUNTING.

DIM	MILLIMETERS		
	MIN.	NOM.	MAX.
A	0.90	1.00	1.10
A1	0.00	---	0.05
b	0.33	0.41	0.51
c	0.23	0.28	0.33
D	5.00	5.15	5.30
D1	4.70	4.90	5.10
E	6.00	6.15	6.30
E1	5.70	5.90	6.10
E2	3.45	3.65	3.85
e	1.27 BSC		
G	0.51	0.575	0.71
K	1.20	1.35	1.50
L	0.51	0.575	0.71
L1	0.150 REF		
M	3.00	3.40	3.80
θ	0°	---	12°

GENERIC MARKING DIAGRAM*



- XXXXXX = Specific Device Code
 A = Assembly Location
 Y = Year
 W = Work Week
 ZZ = Lot Traceability
- *This information is generic. Please refer to device data sheet for actual part marking. Pb-Free indicator, "G" or microdot "•", may or may not be present. Some products may not follow the Generic Marking.

DOCUMENT NUMBER:	98AON26450H	Electronic versions are uncontrolled except when accessed directly from the Document Repository. Printed versions are uncontrolled except when stamped "CONTROLLED COPY" in red.
DESCRIPTION:	DFNW5 5x6 (FULL-CUT SO8FL WF)	PAGE 1 OF 1

ON Semiconductor and ON are trademarks of Semiconductor Components Industries, LLC dba ON Semiconductor or its subsidiaries in the United States and/or other countries. ON Semiconductor reserves the right to make changes without further notice to any products herein. ON Semiconductor makes no warranty, representation or guarantee regarding the suitability of its products for any particular purpose, nor does ON Semiconductor assume any liability arising out of the application or use of any product or circuit, and specifically disclaims any and all liability, including without limitation special, consequential or incidental damages. ON Semiconductor does not convey any license under its patent rights nor the rights of others.

onsemi, **Onsemi**, and other names, marks, and brands are registered and/or common law trademarks of Semiconductor Components Industries, LLC dba "**onsemi**" or its affiliates and/or subsidiaries in the United States and/or other countries. **onsemi** owns the rights to a number of patents, trademarks, copyrights, trade secrets, and other intellectual property. A listing of **onsemi**'s product/patent coverage may be accessed at www.onsemi.com/site/pdf/Patent-Marking.pdf. **onsemi** reserves the right to make changes at any time to any products or information herein, without notice. The information herein is provided "as-is" and **onsemi** makes no warranty, representation or guarantee regarding the accuracy of the information, product features, availability, functionality, or suitability of its products for any particular purpose, nor does **onsemi** assume any liability arising out of the application or use of any product or circuit, and specifically disclaims any and all liability, including without limitation special, consequential or incidental damages. Buyer is responsible for its products and applications using **onsemi** products, including compliance with all laws, regulations and safety requirements or standards, regardless of any support or applications information provided by **onsemi**. "Typical" parameters which may be provided in **onsemi** data sheets and/or specifications can and do vary in different applications and actual performance may vary over time. All operating parameters, including "Typicals" must be validated for each customer application by customer's technical experts. **onsemi** does not convey any license under any of its intellectual property rights nor the rights of others. **onsemi** products are not designed, intended, or authorized for use as a critical component in life support systems or any FDA Class 3 medical devices or medical devices with a same or similar classification in a foreign jurisdiction or any devices intended for implantation in the human body. Should Buyer purchase or use **onsemi** products for any such unintended or unauthorized application, Buyer shall indemnify and hold **onsemi** and its officers, employees, subsidiaries, affiliates, and distributors harmless against all claims, costs, damages, and expenses, and reasonable attorney fees arising out of, directly or indirectly, any claim of personal injury or death associated with such unintended or unauthorized use, even if such claim alleges that **onsemi** was negligent regarding the design or manufacture of the part. **onsemi** is an Equal Opportunity/Affirmative Action Employer. This literature is subject to all applicable copyright laws and is not for resale in any manner.

PUBLICATION ORDERING INFORMATION

LITERATURE FULFILLMENT:

Email Requests to: orderlit@onsemi.com

onsemi Website: www.onsemi.com

TECHNICAL SUPPORT

North American Technical Support:

Voice Mail: 1 800-282-9855 Toll Free USA/Canada

Phone: 011 421 33 790 2910

Europe, Middle East and Africa Technical Support:

Phone: 00421 33 790 2910

For additional information, please contact your local Sales Representative