

MOSFET – Power, N-Channel, Automotive SUPERFET® III, Easy-drive 650 V, 75 A, 25 mΩ

NVHL025N65S3

Description

SuperFET III MOSFET is ON Semiconductor’s brand-new high voltage super-junction (SJ) MOSFET family that is utilizing charge balance technology for outstanding low on-resistance and lower gate charge performance. This advanced technology is tailored to minimize conduction loss provide superior switching performance, and withstand extreme dv/dt rate. Consequently, SuperFET III MOSFET Easy-drive series helps manage EMI issues and allows for easier design implementation.

Features

- AEC-Q101 Qualified
- Max Junction Temperature 150°C
- Typ. $R_{DS(on)} = 19.9 \text{ m}\Omega$
- Ultra Low Gate Charge (Typ. $Q_G = 236 \text{ nC}$)
- Low Effective Output Capacitance (Typ. $C_{OSS(eff.)} = 2062 \text{ pF}$)
- 100% Avalanche Tested
- These Devices are Pb-Free and are RoHS Compliant

Typical Applications

- Automotive PHEV-BEV DC-DC Converter
- Automotive Onboard Charger for PHEV-BEV

| BV_{DSS} | $R_{DS(on)} \text{ MAX}$ | $I_D \text{ MAX}$ |
|------------|--------------------------|-------------------|
| 650 V | 25 mΩ @ 10 V | 75 A |

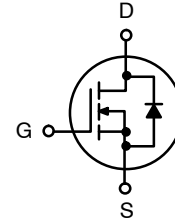

N-Channel MOSFET

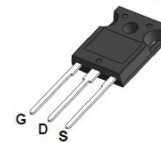

TO-247-3LD
CASE 340CX

MARKING DIAGRAM

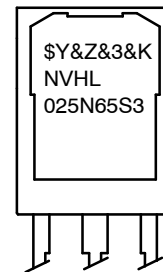

| | |
|--------------|-------------------------|
| \$Y | = ON Semiconductor Logo |
| &Z | = Assembly Plant Code |
| &3 | = Numeric Date Code |
| &K | = Lot Code |
| NVHL025N65S3 | = Specific Device Code |

ORDERING INFORMATION

See detailed ordering and shipping information on page 2 of this data sheet.

NVHL025N65S3

ABSOLUTE MAXIMUM RATINGS (T_C = 25°C, Unless otherwise specified)

| Symbol | Parameter | | Value | Unit |
|-----------------------------------|--|-------------------------------------|-------------|------|
| V _{DSS} | Drain to Source Voltage | | 650 | V |
| V _{GSS} | Gate to Source Voltage | DC Positive | 30 | V |
| | | AC Positive, (f > 1 Hz) | 30 | V |
| | | AC Negative, (f > 1 Hz) | -20 | V |
| I _D | Drain Current | Continuous (T _c = 25°C) | 75 | A |
| | | Continuous (T _c = 100°C) | 65.8 | A |
| I _{DM} | Pulsed Drain Current | Pulsed (Note 1) | 300 | A |
| E _{AS} | Single Pulsed Avalanche Energy (Note 2) | | 2025 | mJ |
| E _{AR} | Repetitive Avalanche (Note 1) | | 5.95 | mJ |
| dv/dt | MOSFET dv/dt | | 100 | V/ns |
| | Peak Diode Recovery dv/dt (Note 3) | | 20 | V/ns |
| P _D | Power Dissipation | (T _c = 25°C) | 595 | W |
| | | Derate Above 25°C | 4.76 | W/°C |
| T _J , T _{STG} | Operating and Storage Temperature Range | | -55 to +150 | °C |
| T _L | Maximum Lead Temperature for Soldering, 1/8" from Case for 5 Seconds | | 300 | °C |

Stresses exceeding those listed in the Maximum Ratings table may damage the device. If any of these limits are exceeded, device functionality should not be assumed, damage may occur and reliability may be affected.

1. Repetitive rating: pulse-width limited by maximum junction temperature.
2. I_{AS} = 15 A, R_G = 25 Ω, starting T_J = 25°C.
3. I_{SD} < 75 A, di/dt ≤ 200 A/ms, VDD ≤ BVDSS, starting T_J = 25°C.
4. Essentially independent of operating temperature typical characteristics.

THERMAL CHARACTERISTICS

| Symbol | Parameter | Value | Unit |
|------------------|--|-------|------|
| R _{θJC} | Thermal Resistance, Junction to Case, Max | 0.21 | °C/W |
| R _{θJA} | Thermal Resistance, Junction to Ambient, Max | 40 | °C/W |

PACKAGE MARKING AND ORDERING INFORMATION

| Part Number | Top Marking | Package | Packing Method | Shipping (Qty / Packing) |
|--------------|--------------|------------|----------------|--------------------------|
| NVHL025N65S3 | NVHL025N65S3 | TO-247-3LD | Tube | 30 Units / Tube |

NVHL025N65S3

ELECTRICAL CHARACTERISTICS (T_C = 25°C unless otherwise noted)

| Symbol | Parameter | Test Conditions | Min | Typ | Max | Unit |
|--------|-----------|-----------------|-----|-----|-----|------|
|--------|-----------|-----------------|-----|-----|-----|------|

OFF CHARACTERISTICS

| | | | | | | |
|--------------------------------------|---|--|-----|------|------|------|
| BV _{DSS} | Drain-to-Source Breakdown Voltage | V _{GS} = 0 V, I _D = 1 mA, T _J = 25°C | 650 | 713 | - | V |
| | | V _{GS} = 0 V, I _D = 1 mA, T _J = 150°C | 650 | 755 | - | V |
| ΔBV _{DSS} / ΔT _J | Breakdown Voltage Temperature Coefficient | I _D = 1 mA, Referenced to 25°C | - | 0.34 | - | V/°C |
| I _{DSS} | Zero Gate Voltage Drain Current | V _{DS} = 650 V, V _{GS} = 0 V | - | 0.30 | 1 | μA |
| | | V _{DS} = 520 V, V _{GS} = 0 V, T _c = 125°C | - | 7.92 | - | |
| I _{GSS} | Gate to Body Leakage Current | V _{GS} = +30 V, V _{DS} = 0 V | - | 5.27 | +100 | nA |
| | | V _{GS} = -20 V, V _{DS} = 0 V | - | 2.65 | -100 | nA |

ON CHARACTERISTICS

| | | | | | | |
|---------------------|--------------------------------------|---|-----|------|-----|----|
| V _{GS(th)} | Gate to Source Threshold Voltage | V _{GS} = V _{DS} , I _D = 3.0 mA | 2.5 | 3.56 | 4.5 | V |
| R _{DS(on)} | Static Drain to Source On Resistance | V _{GS} = 10 V, I _D = 37.5 A, T _J = 25°C | - | 19.9 | 25 | mΩ |
| | | V _{GS} = 10 V, I _D = 37.5 A, T _J = 100°C | - | 34.6 | - | mΩ |
| g _{FS} | Forward Transconductance | V _{DS} = 20 V, I _D = 75 A | - | 78.5 | - | S |

DYNAMIC CHARACTERISTICS

| | | | | | | |
|------------------------|-----------------------------------|--|-----------|------|-------|----|
| C _{iss} | Input Capacitance | V _{DS} = 400 V, V _{GS} = 0 V, f = 1 MHz | - | 7330 | - | pF |
| C _{oss} | Output Capacitance | | - | 197 | - | pF |
| C _{rss} | Reverse Transfer Capacitance | | - | 33.6 | - | pF |
| C _{oss(eff.)} | Effective Output Capacitance | V _{DS} = 0 V to 400 V, V _{GS} = 0 V | - | 2062 | - | pF |
| C _{oss(er.)} | Energy Related Output Capacitance | V _{DS} = 0 V to 400 V, V _{GS} = 0 V | - | 285 | - | pF |
| Q _{g(tot)} | Total Gate Charge | V _{DS} = 400 V, V _{GS} = 10 V, I _D = 75 A (Note 4) | - | 236 | - | nC |
| Q _{gs} | Gate to Source Gate Charge | | - | 59.3 | - | nC |
| Q _{gd} | Gate to Drain "Miller" Charge | | - | 97.3 | - | nC |
| R _G | Gate Resistance | | f = 1 MHz | - | 0.818 | - |

SWITCHING CHARACTERISTICS

| | | | | | | |
|---------------------|---------------------|--|---|------|---|----|
| t _{d(on)} | Turn-On Delay Time | V _{DD} = 400 V, I _D = 75 A, V _{GS} = 10 V, R _G = 2 Ω (Note 4) | - | 43.3 | - | ns |
| t _r | Turn-On Rise Time | | - | 109 | - | ns |
| t _{d(off)} | Turn-Off Delay Time | | - | 120 | - | ns |
| t _f | Fall Time | | - | 107 | - | ns |

DRAIN-SOURCE DIODE CHARACTERISTICS

| | | | | | | |
|-----------------|--|--|---|------|-----|----|
| I _S | Maximum Continuous Drain to Source Diode Forward Current | - | - | 75 | A | |
| I _{SM} | Maximum Pulsed Drain to Source Diode Forward Current | - | - | 300 | A | |
| V _{SD} | Drain to Source Diode Forward Voltage | V _{GS} = 0 V, I _{SD} = 37.5 A | - | 0.88 | 1.2 | V |
| t _{rr} | Reverse Recovery Time | V _{GS} = 0 V, I _{SD} = 75 A dI _F /dt = 100 A/μs | - | 714 | - | nS |
| Q _{rr} | Reverse Recovery Charge | | - | 26.4 | - | μC |

Product parametric performance is indicated in the Electrical Characteristics for the listed test conditions, unless otherwise noted. Product performance may not be indicated by the Electrical Characteristics if operated under different conditions.

TYPICAL CHARACTERISTICS

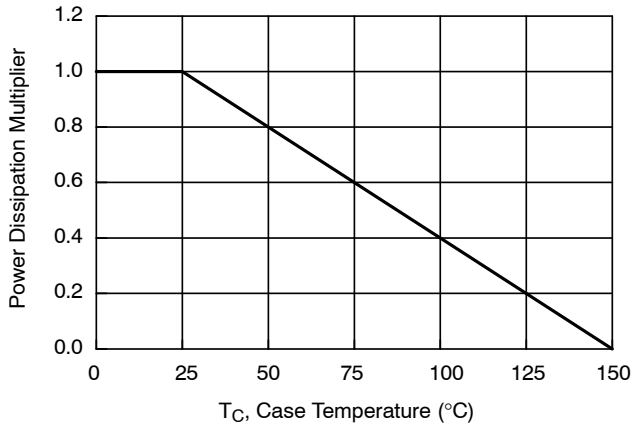

Figure 1. Normalized Power Dissipation vs. Case Temperature

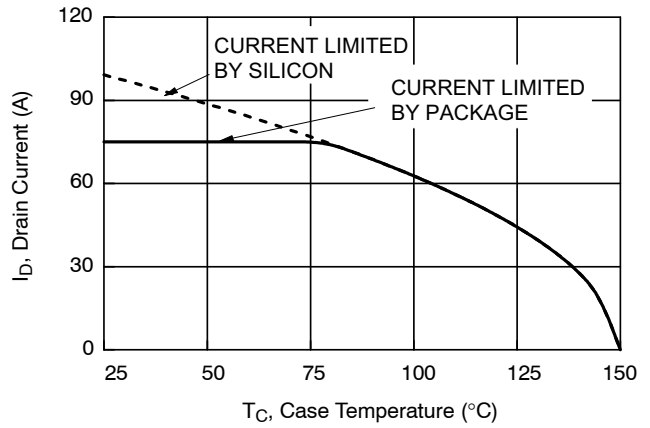

Figure 2. Maximum Continuous Drain Current vs. Case Temperature

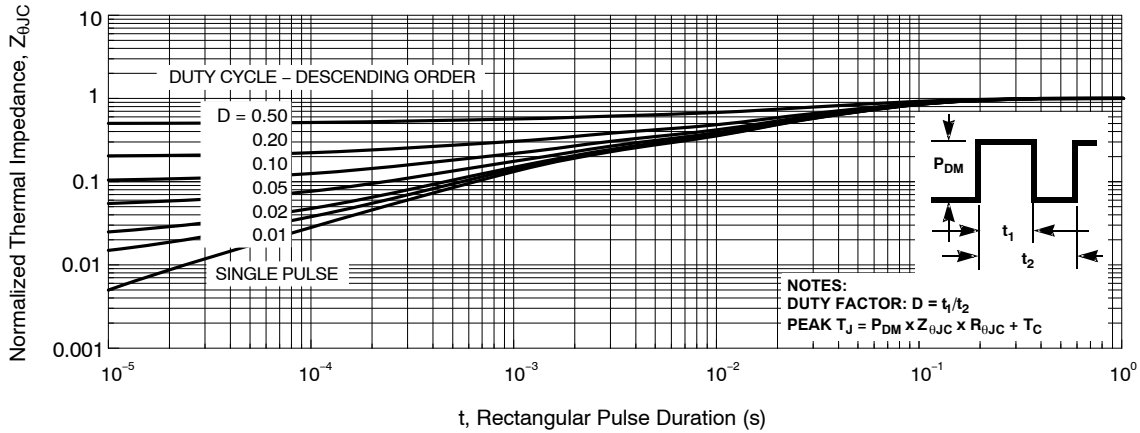

Figure 3. Normalized Maximum Transient Thermal Impedance

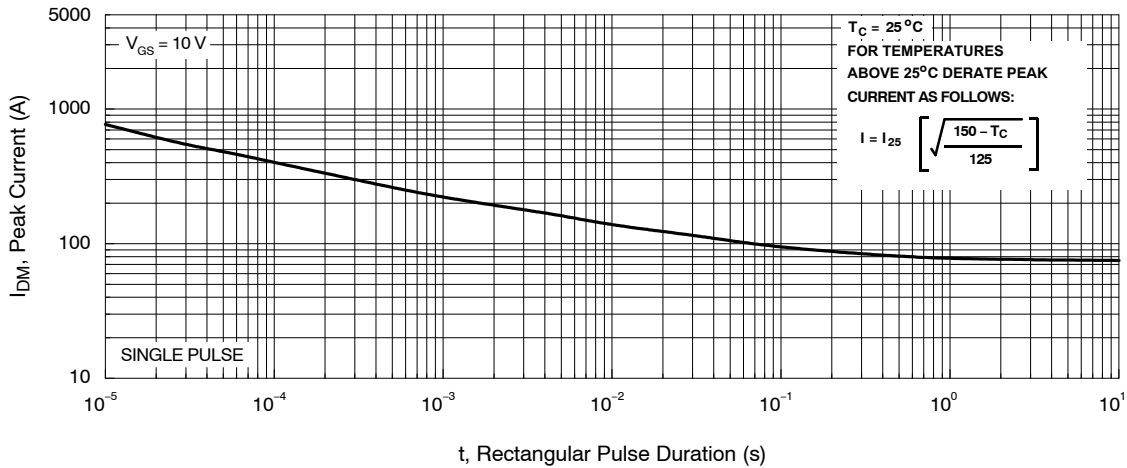

Figure 4. Peak Current Capability

TYPICAL CHARACTERISTICS (continued)

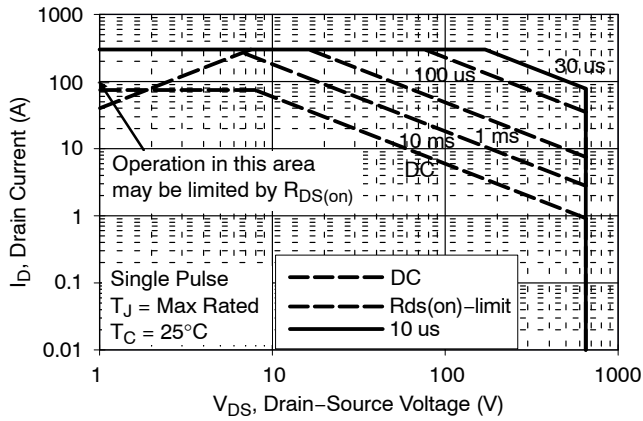

Figure 5. Forward Bias Safe Operating Area

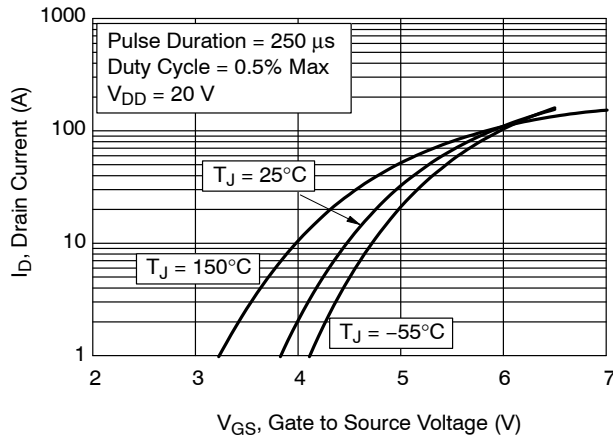

Figure 6. Transfer Characteristic

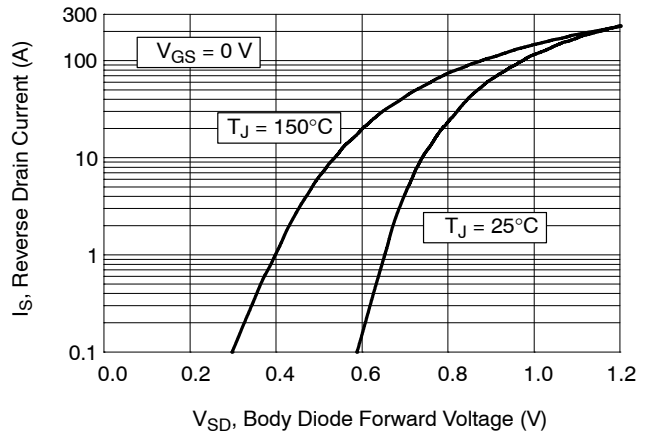

Figure 7. Forward Diode Characteristics

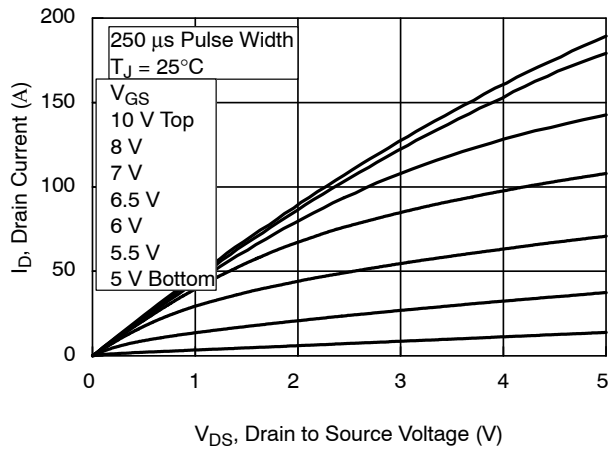

Figure 8. Saturation Characteristics

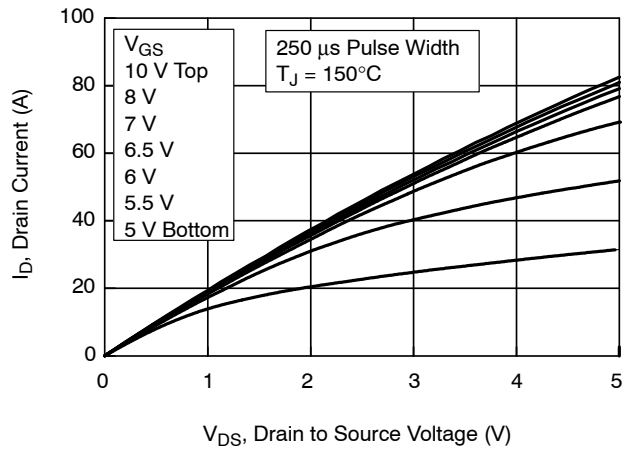

Figure 9. Saturation Characteristics

TYPICAL CHARACTERISTICS (continued)

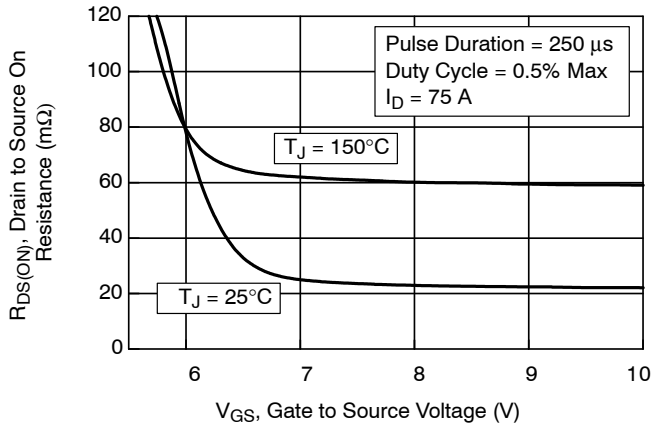

Figure 10. $R_{DS(on)}$ vs. Gate Voltage

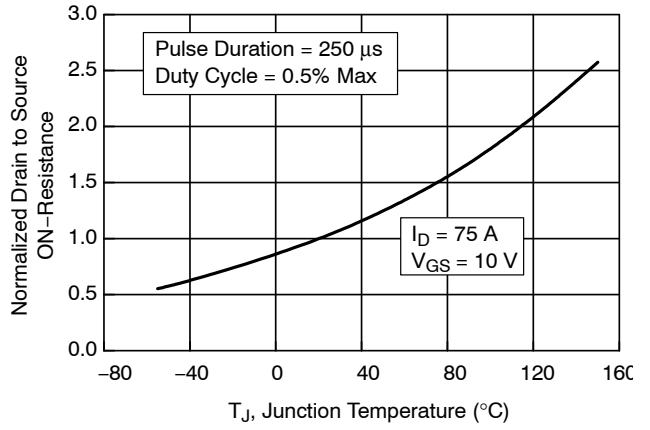

Figure 11. Normalized $R_{DS(on)}$ vs. Junction Temperature

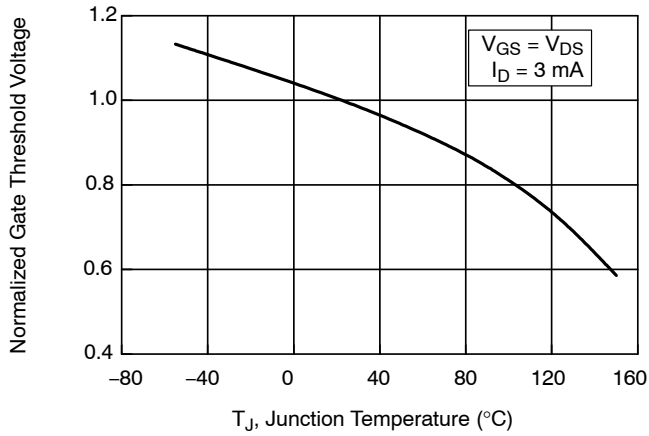

Figure 12. Normalized Gate Threshold Voltage vs. Temperature

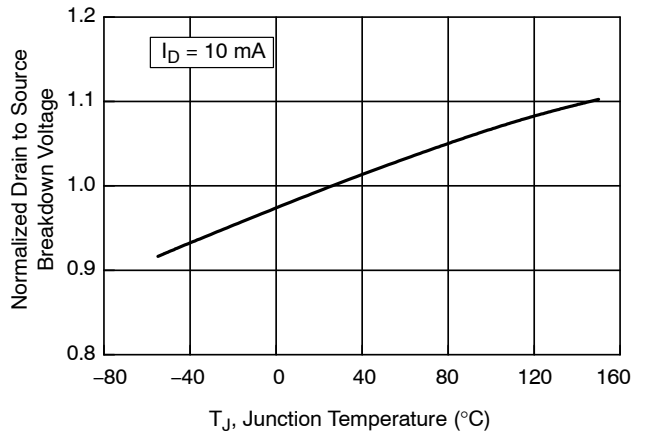

Figure 13. Normalized Drain to Source Breakdown Voltage vs. Junction Temperature

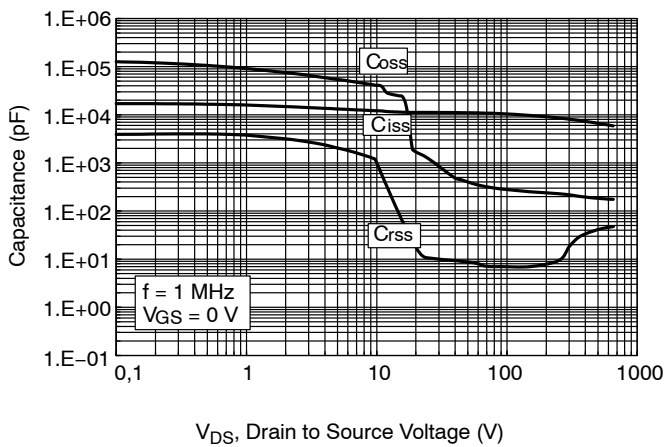

Figure 14. Capacitance vs. Drain to Source Voltage

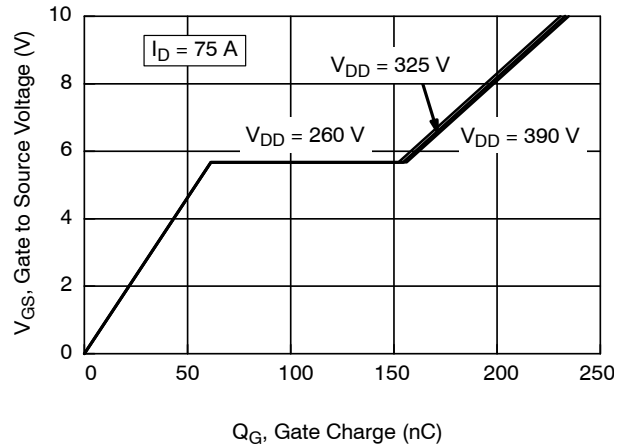

Figure 15. Gate Charge vs. Gate to Source Voltage

NVHL025N65S3

TYPICAL CHARACTERISTICS (continued)

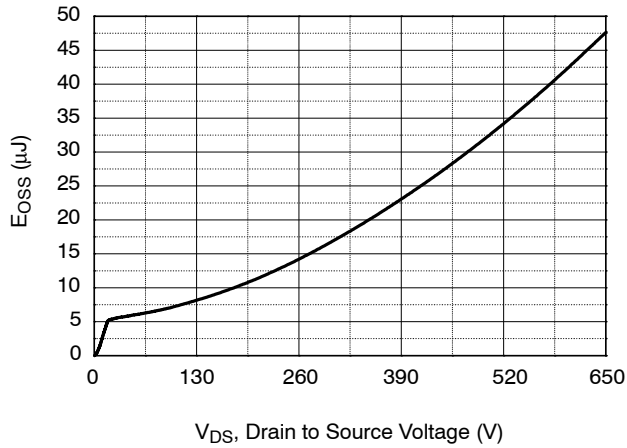

Figure 16. E_{OSS} vs. Drain to Source Voltage

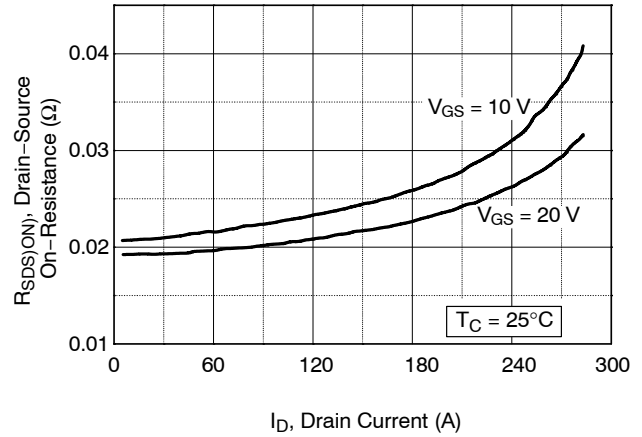

Figure 17. On-Resistance Variation vs. Drain Current and Gate Voltage

MECHANICAL CASE OUTLINE

PACKAGE DIMENSIONS

ON Semiconductor®



TO-247-3LD
CASE 340CX
ISSUE A

DATE 06 JUL 2020



NOTES: UNLESS OTHERWISE SPECIFIED.

- A. DIMENSIONS ARE EXCLUSIVE OF BURRS, MOLD FLASH, AND TIE BAR EXTRUSIONS.
- B. ALL DIMENSIONS ARE IN MILLIMETERS.
- C. DRAWING CONFORMS TO ASME Y14.5 - 2009.
- D. DIMENSION A1 TO BE MEASURED IN THE REGION DEFINED BY L1.
- E. LEAD FINISH IS UNCONTROLLED IN THE REGION DEFINED BY L1.

| DIM | MILLIMETERS | | |
|-----|-------------|-------|-------|
| | MIN | NOM | MAX |
| A | 4.58 | 4.70 | 4.82 |
| A1 | 2.20 | 2.40 | 2.60 |
| A2 | 1.40 | 1.50 | 1.60 |
| D | 20.32 | 20.57 | 20.82 |
| E | 15.37 | 15.62 | 15.87 |
| E2 | 4.96 | 5.08 | 5.20 |
| e | ~ | 5.56 | ~ |
| L | 19.75 | 20.00 | 20.25 |
| L1 | 3.69 | 3.81 | 3.93 |
| ØP | 3.51 | 3.58 | 3.65 |
| Q | 5.34 | 5.46 | 5.58 |
| S | 5.34 | 5.46 | 5.58 |
| b | 1.17 | 1.26 | 1.35 |
| b2 | 1.53 | 1.65 | 1.77 |
| b4 | 2.42 | 2.54 | 2.66 |
| c | 0.51 | 0.61 | 0.71 |
| D1 | 13.08 | ~ | ~ |
| D2 | 0.51 | 0.93 | 1.35 |
| E1 | 12.81 | ~ | ~ |
| ØP1 | 6.60 | 6.80 | 7.00 |

GENERIC MARKING DIAGRAM*



- XXXXX = Specific Device Code
- A = Assembly Location
- Y = Year
- WW = Work Week
- G = Pb-Free Package

*This information is generic. Please refer to device data sheet for actual part marking. Pb-Free indicator, "G" or microdot "▪", may or may not be present. Some products may not follow the Generic Marking.

| | | |
|-------------------------|--------------------|--|
| DOCUMENT NUMBER: | 98AON93302G | Electronic versions are uncontrolled except when accessed directly from the Document Repository. Printed versions are uncontrolled except when stamped "CONTROLLED COPY" in red. |
| DESCRIPTION: | TO-247-3LD | PAGE 1 OF 1 |

ON Semiconductor and are trademarks of Semiconductor Components Industries, LLC dba ON Semiconductor or its subsidiaries in the United States and/or other countries. ON Semiconductor reserves the right to make changes without further notice to any products herein. ON Semiconductor makes no warranty, representation or guarantee regarding the suitability of its products for any particular purpose, nor does ON Semiconductor assume any liability arising out of the application or use of any product or circuit, and specifically disclaims any and all liability, including without limitation special, consequential or incidental damages. ON Semiconductor does not convey any license under its patent rights nor the rights of others.

onsemi, **Onsemi**, and other names, marks, and brands are registered and/or common law trademarks of Semiconductor Components Industries, LLC dba "**onsemi**" or its affiliates and/or subsidiaries in the United States and/or other countries. **onsemi** owns the rights to a number of patents, trademarks, copyrights, trade secrets, and other intellectual property. A listing of **onsemi**'s product/patent coverage may be accessed at www.onsemi.com/site/pdf/Patent-Marking.pdf. **onsemi** reserves the right to make changes at any time to any products or information herein, without notice. The information herein is provided "as-is" and **onsemi** makes no warranty, representation or guarantee regarding the accuracy of the information, product features, availability, functionality, or suitability of its products for any particular purpose, nor does **onsemi** assume any liability arising out of the application or use of any product or circuit, and specifically disclaims any and all liability, including without limitation special, consequential or incidental damages. Buyer is responsible for its products and applications using **onsemi** products, including compliance with all laws, regulations and safety requirements or standards, regardless of any support or applications information provided by **onsemi**. "Typical" parameters which may be provided in **onsemi** data sheets and/or specifications can and do vary in different applications and actual performance may vary over time. All operating parameters, including "Typicals" must be validated for each customer application by customer's technical experts. **onsemi** does not convey any license under any of its intellectual property rights nor the rights of others. **onsemi** products are not designed, intended, or authorized for use as a critical component in life support systems or any FDA Class 3 medical devices or medical devices with a same or similar classification in a foreign jurisdiction or any devices intended for implantation in the human body. Should Buyer purchase or use **onsemi** products for any such unintended or unauthorized application, Buyer shall indemnify and hold **onsemi** and its officers, employees, subsidiaries, affiliates, and distributors harmless against all claims, costs, damages, and expenses, and reasonable attorney fees arising out of, directly or indirectly, any claim of personal injury or death associated with such unintended or unauthorized use, even if such claim alleges that **onsemi** was negligent regarding the design or manufacture of the part. **onsemi** is an Equal Opportunity/Affirmative Action Employer. This literature is subject to all applicable copyright laws and is not for resale in any manner.

PUBLICATION ORDERING INFORMATION

LITERATURE FULFILLMENT:

Email Requests to: orderlit@onsemi.com

onsemi Website: www.onsemi.com

TECHNICAL SUPPORT

North American Technical Support:

Voice Mail: 1 800-282-9855 Toll Free USA/Canada

Phone: 011 421 33 790 2910

Europe, Middle East and Africa Technical Support:

Phone: 00421 33 790 2910

For additional information, please contact your local Sales Representative